



Surface Mount LVPECL Clock Oscillator

CONNOR WINFIELD



2111 Comprehensive Drive
Aurora, Illinois 60505
Phone: 630-851-4722
Fax: 630-851-5040
www.conwin.com
US Headquarters:
630-851-4722
European Headquarters:
+353-61-472221

Description:

The Connor Winfield Pxxx Series are 5.0x7.0mm Surface Mount, LVPECL, Fixed Frequency Crystal Controlled Oscillator (XO) designed for applications requiring tight frequency stability, wide temperature range and low jitter. Operating at 2.5V or 3.3V supply voltage, the Pxxx Series provides an LVPECL Differential Outputs with enable / disable function. The surface mount package is designed for high-density mounting and is optimum for mass production.

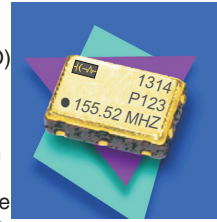

Features:

Model Pxxx - Series
5.0 x7.0mm Surface Mount Package
2.5V or 3.3V Operation
LVPECL Differential Outputs
Frequency Stabilities Available:
+/-20ppm, +/-25ppm, +/-50ppm, +/-100ppm
Temperature Ranges Available:
0 to 70°C, -40 to 85°C, 0 to 85°C, -20 to 70°C
Low Jitter <1pS RMS
Tri-State Enable/Disable on Pad 1 or 2
Tape and Reel Packaging
RoHS Compliant / Lead Free

Absolute Maximum Ratings

Parameter	Minimum	Nominal	Maximum	Units	Notes
Storage Temperature	-55	-	125	°C	
Supply Voltage (Vcc)	-0.5	-	5.0	Vdc	
Input Voltage (Vc)	-0.5	-	Vcc + 0.5	Vdc	

Operating Specifications

Parameter	Minimum	Nominal	Maximum	Units	Notes
Output Frequency (Fo)	25	-	312.5	MHz	
Total Frequency Tolerance	(See Ordering Information for full part number)				
Model Px4x	-20	-	20	ppm	1
Model Px1x	-25	-	25	ppm	1
Model Px2x	-50	-	50	ppm	1
Model Px3x	-100	-	100	ppm	1
Operating Temperature Range					
Model P1xx	0	-	70	°C	
Model P2xx	-40	-	85	°C	2
Model P3xx	0	-	85	°C	
Model P4xx	-20	-	70	°C	
Supply Voltage (Vcc)					
Model Pxx2, Pxx5	2.375	2.5	2.625	Vdc	
Model Pxx3, Pxx4	3.135	3.3	3.465	Vdc	
Supply Current (Icc)	-	60	90	mA	
Jitter:					
Period Jitter	-	3.0	5.0	ps RMS	
Integrated Phase Jitter (BW = 12 KHz to 20 MHz)					
25 ≤ Fo ≤ 60 MHz	-	1.3	2.0	ps RMS	
60 < Fo ≤ 80 MHz	-	0.80	1.0	ps RMS	
80 < Fo ≤ 100 MHz	-	0.60	0.80	ps RMS	
100 < Fo ≤ 160 MHz	-	0.40	0.50	ps RMS	
160 < Fo ≤ 200 MHz	-	0.30	0.40	ps RMS	
200 < Fo ≤ 312.5 MHz	-	0.20	0.30	ps RMS	
SSB Phase Noise					
@ 10 Hz offset	-	-60	-	dBc/Hz	
@ 100 Hz offset	-	-90	-	dBc/Hz	
@ 1 KHz offset	-	-115	-	dBc/Hz	
@ 10 KHz offset	-	-140	-	dBc/Hz	
@ 100 KHz offset	-	-145	-	dBc/Hz	
Start-Up Time	-	-	2	ms	

Input Characteristics

Parameter	Minimum	Nominal	Maximum	Units	Notes
Enable / Disable Option:					
Models Pxx2, Pxx3 E/D Pad 1. N/C Pad 1					
Models Pxx4, Pxx5 E/D Pad 2. N/C Pad 2					
Enable Input Voltage - (High) - (Vih)	70%Vcc	-	-	Vdc	3
Disable Input Voltage - (Low) - (Vil)	-	-	30%Vcc	Vdc	3
Enable Time	-	-	2	ms	
Disable Time	-	-	200	ns	
Standby Current (When Osc. is disabled)	-	-	30	uA	

LVPECL Output Characteristics

Parameter	Minimum	Nominal	Maximum	Units	Notes
Load	-	50	-	Ohm	4
Voltage (High) (Vcc = 2.5 V) (Voh)	1.475	-	-	V	
(Low) (Vcc = 2.5 V) (Vol)	-	-	0.880	V	
Voltage (High) (Vcc = 3.3 V) (Voh)	2.275	-	-	V	
(Low) (Vcc = 3.3 V) (Vol)	-	-	1.680	V	
Duty Cycle at 50% Level	45	50	55	%	5
Rise / Fall Time: 20% to 80%	-	0.5	1.0	ns	

Specifications subject to change without notice. All dimensions in inches. © Copyright 2010 The Connor-Winfield Corporation



**RoHS
COMPLIANT**

Bulletin **Ec217**
Page **1 of 2**
Revision **14**
Date **03 Apr 2013**



Notes:

1. Includes calibration @ 25°C, frequency stability vs. change in temperature, supply voltage and load variations, shock and vibration and 20 years aging. Models P242, P243 P244 and P245 are not available above 260 MHz.
2. Models P242, P243 P244 and P245 are not available above 260 MHz.
3. When the oscillator is disabled the outputs are at high impedance. Outputs are enabled with no connection on E/D pad.
4. Outputs must be terminated into 50 ohms to Vcc - 2V or Thevenin equivalent.
5. Duty cycle measured at 50% of output voltage swing.

Ordering Information

P	1	2	3	- 155.52M
Type LVPECL Clock Series 5x7 mm	Temperature Range 1 = 0 to 70°C 2 = -40 to 85°C 3 = 0 to 85°C 4 = -20 to 70°C	Frequency Stability 4 = ±20 ppm 1 = ±25 ppm 2 = ±50 ppm 3 = ±100 ppm	Supply Voltage 2 = 2.5 Vdc, E/D Pad 1 3 = 3.3 Vdc, E/D Pad 1 4 = 3.3 Vdc, E/D Pad 2 5 = 2.5 Vdc, E/D Pad 2	Output Frequency Frequency Format -xxx.xM Min -xxx.xxxxxM Max *Amount of numbers after the decimal point. M = MHz

Example: Part Number

P123-155.52M = LVPECL Output,

0 to 70, +/-20ppm, 3.3Vdc, E/D Pad 1, Output Frequency 155.52MHz

Attention: Models P242, P243, P244 and P245 are not available above 260 MHz.

Package Characteristics

Package Hermetically sealed ceramic package and metal cover

Environmental Characteristics

Vibration: Vibration per Mil Std 883E Method 2007.3 Test Condition A.

Shock: Mechanical Shock per Mil Std 883E Method 2002.4 Test Condition B.

Soldering Process: RoHS compliant lead free. See soldering profile on page 2.

Enable / Disable Function

Function:	Output
Low:	Disabled (High Impedance)
High or Open:	Enabled

Models: Pxx2, Pxx3

1: Enable / Disable	1: N/C
2 N/C	2 Enable / Disable
3: Ground	3: Ground
4: Output Q	4: Output Q
5: Complementary Output \bar{Q}	5: Complementary Output \bar{Q}
6: Supply Voltage (Vcc)	6: Supply Voltage (Vcc)

Models Pxx4, Pxx5

Test Circuit

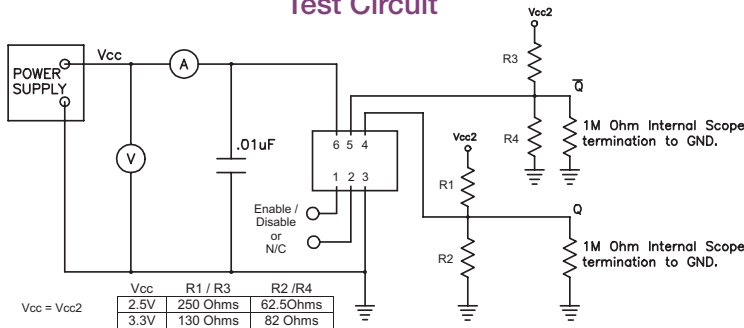

Tap and Reel Dimensions

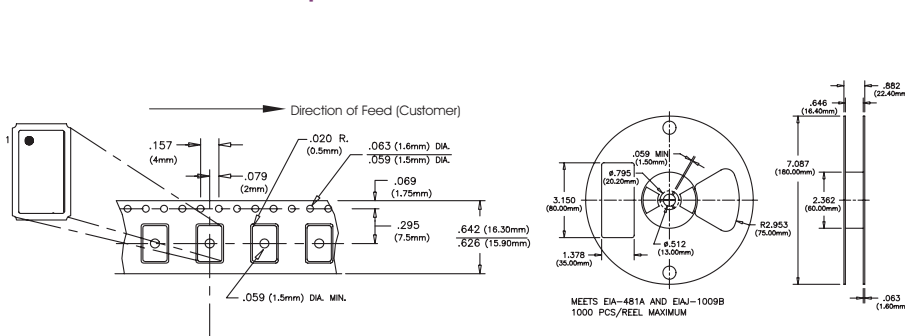

Package Outline

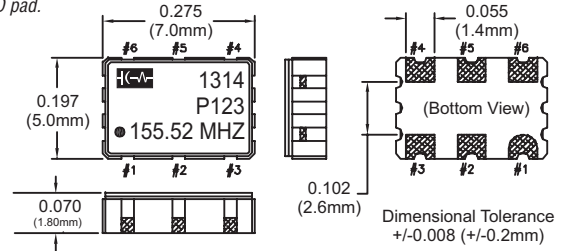

Suggested Pad Layout

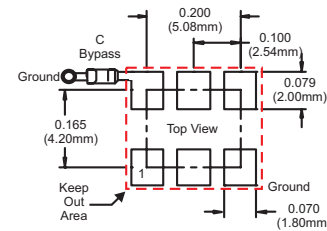

Pad Connections

Output Waveform

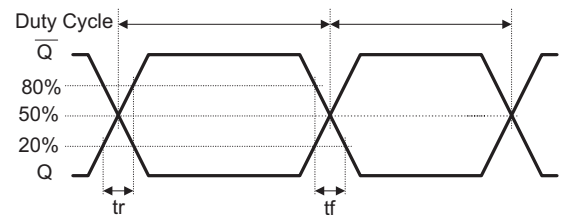

Solder Profile

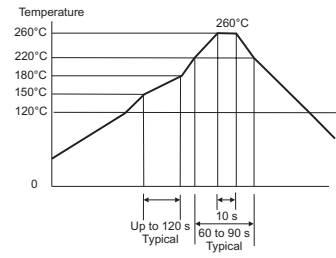

Meets IPC/JEDEC J-STD-020C