

# 5V Low Power RS232 3-Driver/5-Receiver Transceiver with 2 Receivers Active in Shutdown

## FEATURES

- **Low Supply Current: 300 $\mu$ A**
- **Two Receivers Kept Alive in Shutdown**
- **ESD Protection Over  $\pm 10$ kV**
- **Operates from a Single 5V Supply**
- Uses Small Capacitors: 0.1 $\mu$ F
- Operates to 120k Baud
- Three-State Outputs Are High Impedance When Off
- Output Overvoltage Does Not Force Current Back into Supplies
- RS232 I/O Lines Can Be Forced to  $\pm 25$ V Without Damage
- Pin Compatible with LT1137A and LT1237
- Flowthrough Architecture

## APPLICATIONS

- Notebook Computers
- Palmtop Computers

## DESCRIPTION

The LTC<sup>®</sup>1349 is a 3-driver/5-receiver RS232 transceiver with very low supply current. In the no load condition, the supply current is only 300 $\mu$ A. The charge pump only requires four 0.1 $\mu$ F capacitors.

In Shutdown mode, two receivers are kept alive and the supply current is 35 $\mu$ A. All RS232 outputs assume a high impedance state in Shutdown and with the power off.

The LTC1349 is fully compliant with all data rate and overvoltage RS232 specifications. The transceiver can operate up to 120k baud with a 2500pF, 3k $\Omega$  load. Both driver outputs and receiver inputs can be forced to  $\pm 25$ V without damage, and can survive multiple  $\pm 10$ kV ESD strikes.

 LTC and LT are registered trademarks of Linear Technology Corporation.

## TYPICAL APPLICATION

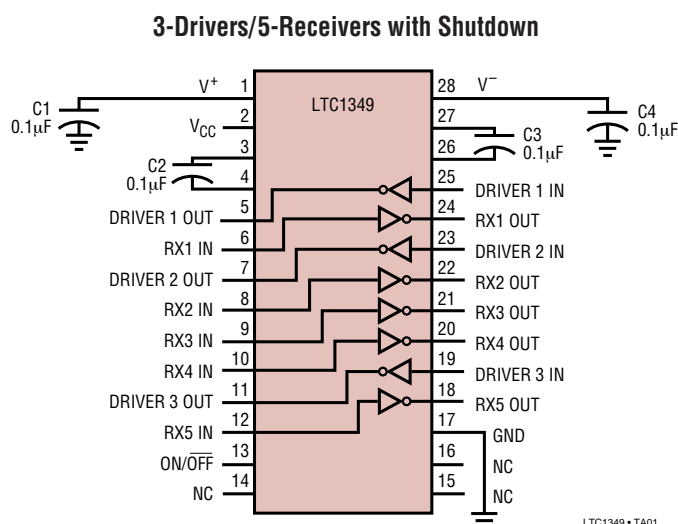

**Quiescent and Shutdown Supply Current vs Temperature**

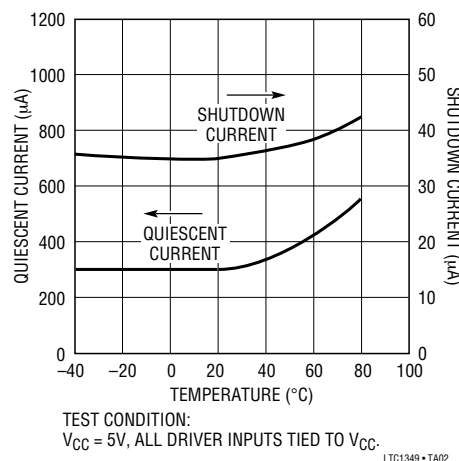

## ABSOLUTE MAXIMUM RATINGS

Supply Voltage ( $V_{CC}$ )	6V
Input Voltage	
Driver	-0.3V to $V_{CC} + 0.3V$
Receiver	-25V to 25V
On/Off Pin	-0.3V to $V_{CC} + 0.3V$
Output Voltage	
Driver	-25V to 25V
Receiver	-0.3V to $V_{CC} + 0.3V$
Short Circuit Duration	
$V^+$	30 sec
$V^-$	30 sec
Driver Output	Indefinite
Receiver Output	Indefinite
Operating Temperature Range	
Commercial (LTC1349C)	0°C to 70°C
Industrial (LTC1349I)	-40°C to 85°C
Storage Temperature Range	-65°C to 150°C
Lead Temperature (Soldering, 10 sec)	300°C

## PACKAGE/ORDER INFORMATION

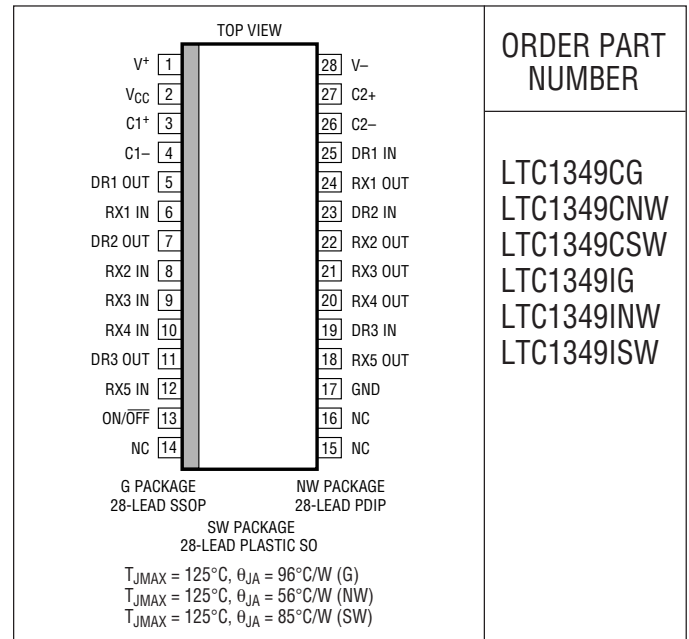

ORDER PART NUMBER

LTC1349CG  
LTC1349CNW  
LTC1349CSW  
LTC1349IG  
LTC1349INW  
LTC1349ISW

Consult LTC Marketing for parts specified with wider operating temperature ranges.

## DC ELECTRICAL CHARACTERISTICS

The ● denotes specifications which apply over the full operating temperature range.  $V_{CC} = 5V$ ,  $C1 = C2 = C3 = C4 = 0.1\mu F$ , unless noted.

PARAMETER	CONDITIONS	MIN	TYP	MAX	UNITS	
<b>Any Driver</b>						
Output Voltage Swing	3k to GND	● 5.0 ● -5.0	7.0 -6.5		V V	
Logic Input Voltage Level	Input Low Level ( $V_{OUT} = \text{High}$ ) Input High Level ( $V_{OUT} = \text{Low}$ )	● 2.0	1.4 1.4	0.8	V V	
Logic Input Current	$V_{IN} = 5V$ $V_{IN} = 0V$	●		5 -5	$\mu A$ $\mu A$	
Output Short-Circuit Current	$V_{OUT} = 0V$		±9	±12	mA	
Output Leakage Current	Shutdown, $V_{OUT} = \pm 20V$ (Note 3)	●	±10	±500	$\mu A$	
<b>Any Receiver</b>						
Input Voltage Thresholds	Input Low Threshold Input High Threshold	●	0.8	1.3 1.7	2.4	V V
Hysteresis		●	0.1	0.4	1.0	V
Input Resistance	$-10V \leq V_{IN} \leq 10V$		3	5	7	k $\Omega$
Output Voltage	Output Low, $I_{OUT} = -1.6mA$ ( $V_{CC} = 5V$ ) Output High, $I_{OUT} = 160\mu A$ ( $V_{CC} = 5V$ )	●	3.5	0.2	4.8	0.4 V
Output Short-Circuit Current	Sinking Current, $V_{OUT} = V_{CC}$		-15	-40		mA
Output Leakage Current	Shutdown, $0 \leq V_{OUT} \leq V_{CC}$ (Note 3)	●		1	10	$\mu A$
<b>Power Supply Generator</b>						
$V^+$ Output Voltage	$I_{OUT} = 0mA$ $I_{OUT} = 12mA$			8.0 7.5	V V	
$V^-$ Output Voltage	$I_{OUT} = 0mA$ $I_{OUT} = -12mA$			-8.0 -7.0	V V	
Supply Rise Time	Shutdown to Turn-On			0.2	ms	

1349fa

## DC ELECTRICAL CHARACTERISTICS

The ● denotes specifications which apply over the full operating temperature range.  $V_{CC} = 5V$ ,  $C1 = C2 = C3 = C4 = 0.1\mu F$ , unless noted.

PARAMETER	CONDITIONS	MIN	TYP	MAX	UNITS
<b>Power Supply</b>					
$V_{CC}$ Supply Current	No Load (All Drivers $V_{IN} = V_{CC}$ )(Note 2), $0^{\circ}C \leq T_A \leq 70^{\circ}C$	●	0.3	0.8	mA
	No Load (All Drivers $V_{IN} = 0V$ )(Note 2), $0^{\circ}C \leq T_A \leq 70^{\circ}C$	●	0.5	1.0	mA
	No Load (All Drivers $V_{IN} = V_{CC}$ )(Note 2), $0^{\circ}C \leq T_A \leq 85^{\circ}C$	●	0.3	1.0	mA
	No Load (All Drivers $V_{IN} = V_{CC}$ )(Note 2), $-40^{\circ}C \leq T_A \leq 0^{\circ}C$	●	0.3	1.5	mA
	No Load (All Drivers $V_{IN} = 0V$ )(Note 2), $-40^{\circ}C \leq T_A \leq 85^{\circ}C$	●	0.5	1.5	mA
Supply Leakage Current ( $V_{CC}$ )	Shutdown (Note 3)	●	35	50	$\mu A$
On/Off Threshold Low		●	1.4	0.8	V
On/Off Threshold High		●	2.0	1.4	V

## AC CHARACTERISTICS

The ● denotes specifications which apply over the full operating temperature range.  $V_{CC} = 5V$ ,  $C1 = C2 = C3 = C4 = 0.1\mu F$ , unless noted.

PARAMETER	CONDITIONS	MIN	TYP	MAX	UNITS
Slew Rate	$R_L = 3k$ , $C_L = 51pF$		8	30	$V/\mu S$
	$R_L = 3k$ , $C_L = 2500pF$	3	5		$V/\mu S$
Driver Propagation Delay (TTL to RS232)	$t_{HLD}$ (Figure 1)	●	2	3.5	$\mu S$
	$t_{LHD}$ (Figure 1)	●	2	3.5	$\mu S$
Receiver Propagation Delay (RS232 to TTL)	$t_{HLR}$ (Figure 2)	●	0.3	0.8	$\mu S$
	$t_{LHR}$ (Figure 2)	●	0.2	0.8	$\mu S$

**Note 1:** Absolute Maximum Ratings are those values beyond which the life of the device may be impaired.

**Note 2:** Supply current is measured with driver and receiver outputs unloaded.

**Note 3:** Supply current and leakage current measurements in Shutdown are performed with  $V_{ON/OFF} = 0V$ .

## TYPICAL PERFORMANCE CHARACTERISTICS

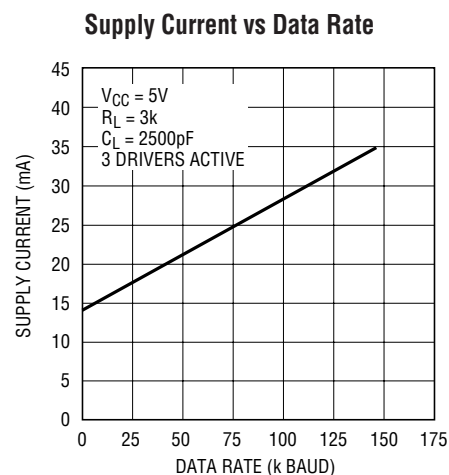
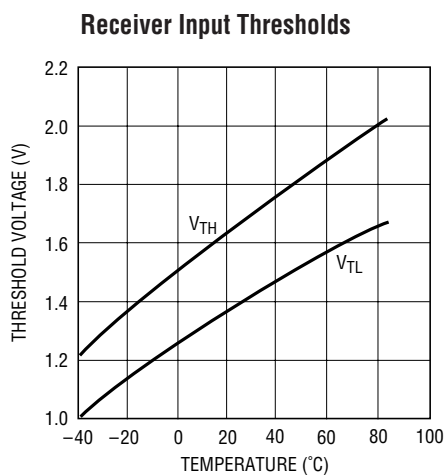
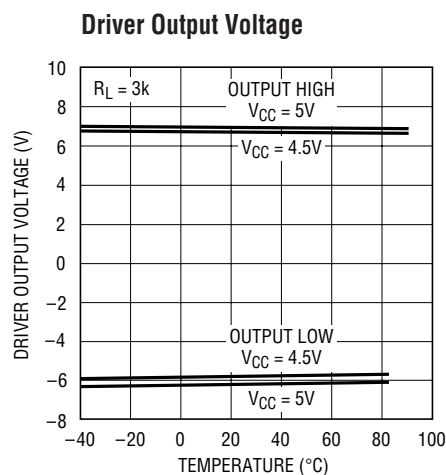

## TYPICAL PERFORMANCE CHARACTERISTICS

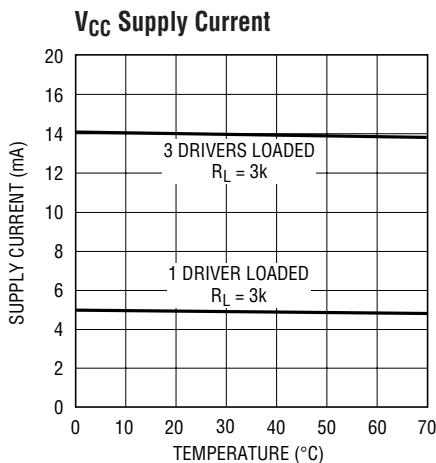

LTC1349 • TPC04

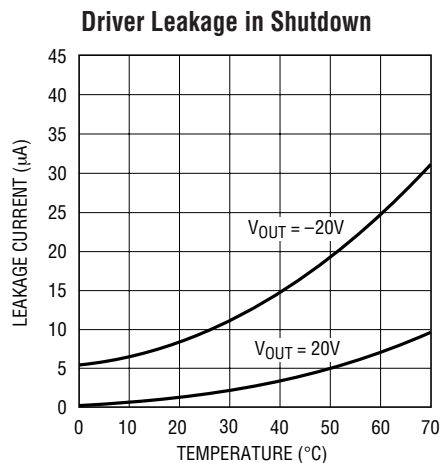

LTC1349 • TPC05

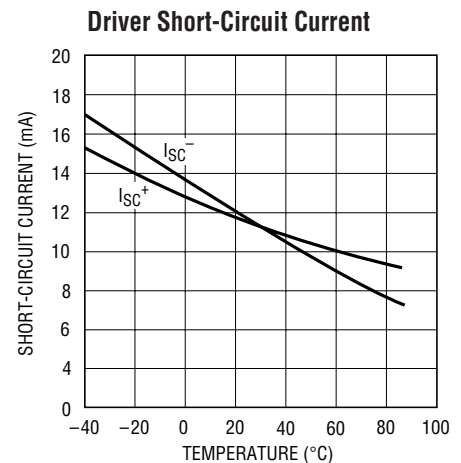

LTC1349 • TPC06

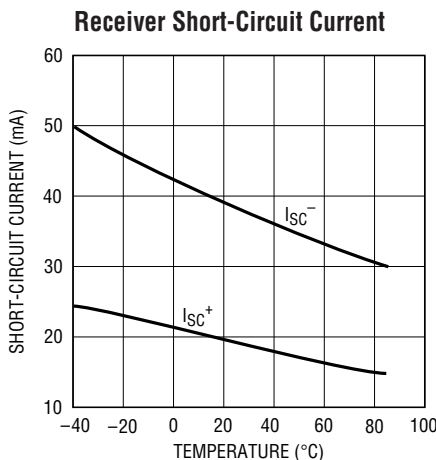

LTC1349 • TPC07

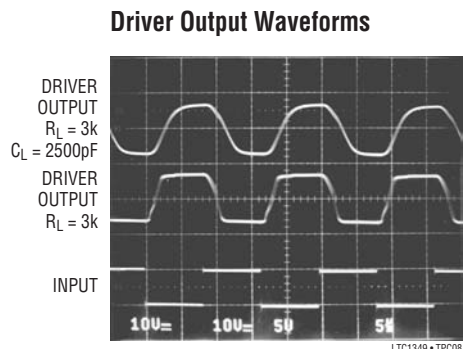

LTC1349 • TPC08

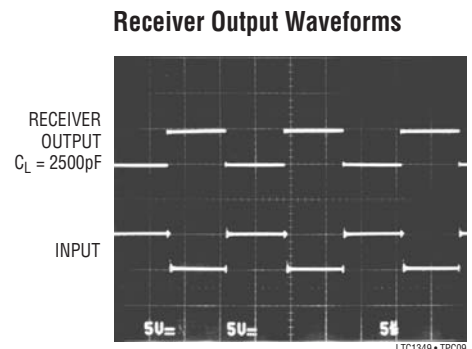

LTC1349 • TPC09

## PIN FUNCTIONS

**V<sub>CC</sub>**: 5V Input Supply Pin. Supply current is typically 35µA in the Shutdown mode. This pin should be decoupled with a 0.1µF ceramic capacitor.

**GND**: Ground Pin.

**ON/OFF**: TTL/CMOS Compatible Shutdown Pin. A logic low puts the device in Shutdown mode, with receivers 4 and 5 kept alive and the supply current equal to 35µA. All driver outputs and other receiver outputs are in high impedance state. This pin can not float.

**V<sup>+</sup>**: Positive Supply Output (RS232 Drivers). V<sup>+</sup> ≅ 2V<sub>CC</sub> - 1V. This pin requires an external capacitor C = 0.1µF for charge storage. The capacitor may be tied to ground or 5V.

With multiple devices, the V<sup>+</sup> and V<sup>-</sup> pins may be paralleled into common capacitors. For large numbers of devices, increasing the size of the shared common storage capacitors is recommended to reduce ripple.

**V<sup>-</sup>**: Negative Supply Output (RS232 Drivers). V<sup>-</sup> ≅ 2V<sub>CC</sub> - 1.5V. This pin requires an external capacitor C = 0.1µF for charge storage.

**C1<sup>+</sup>, C1<sup>-</sup>, C2<sup>+</sup>, C2<sup>-</sup>**: Commutating Capacitor Inputs. These pins require two external capacitors C = 0.1µF: one from C1<sup>+</sup> to C1<sup>-</sup>, and another from C2<sup>+</sup> to C2<sup>-</sup>. To maintain charge pump efficiency, the capacitor's effective series resistance should be less than 20Ω.

## PIN FUNCTIONS

**DRIVER IN:** RS232 Driver Input Pins. Inputs are TTL/CMOS compatible. Inputs should not be allowed to float. Tie unused inputs to  $V_{CC}$ .

**DRIVER OUT:** Driver Outputs at RS232 Voltage Levels. Outputs are in a high impedance state when in Shutdown mode or  $V_{CC} = 0V$ . The driver outputs are protected against ESD to  $\pm 10kV$  for human body model discharges.

**RX IN:** Receiver Inputs. These pins can be forced to  $\pm 25V$  without damage. The receiver inputs are protected against ESD to  $\pm 10kV$  for human body model discharges. Each receiver provides 0.4V of hysteresis for noise immunity.

**RX OUT:** Receiver Outputs with TTL/CMOS Voltage Levels. Receiver 1, 2 and 3 outputs are in a high impedance state when in Shutdown mode to allow data line sharing. Receivers 4 and 5 are kept alive in Shutdown.

## SWITCHING TIME WAVEFORMS

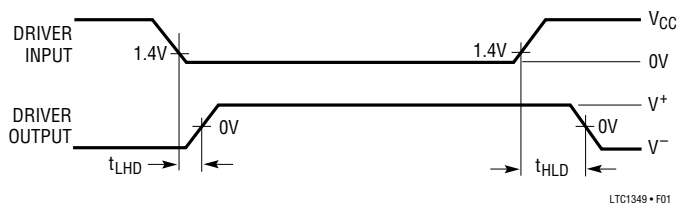

Figure 1. Driver Propagation Delay Timing

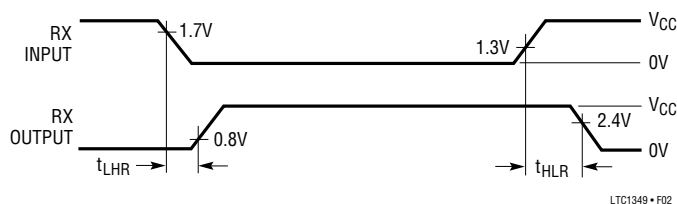
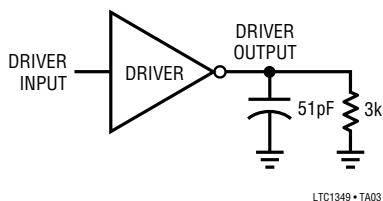

Figure 2. Receiver Propagation Delay Timing

## TEST CIRCUITS

Driver Timing Test Load



Receiver Timing Test Load

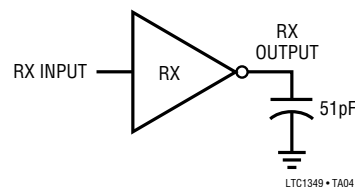

TEST CIRCUITS

ESD Test Circuit

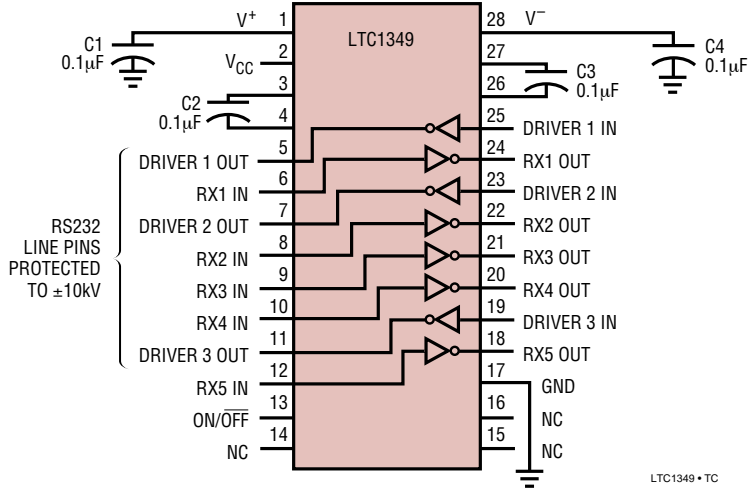

# PACKAGE DESCRIPTION

## G Package 28-Lead Plastic SSOP (5.3mm) (Reference LTC DWG # 05-08-1640)

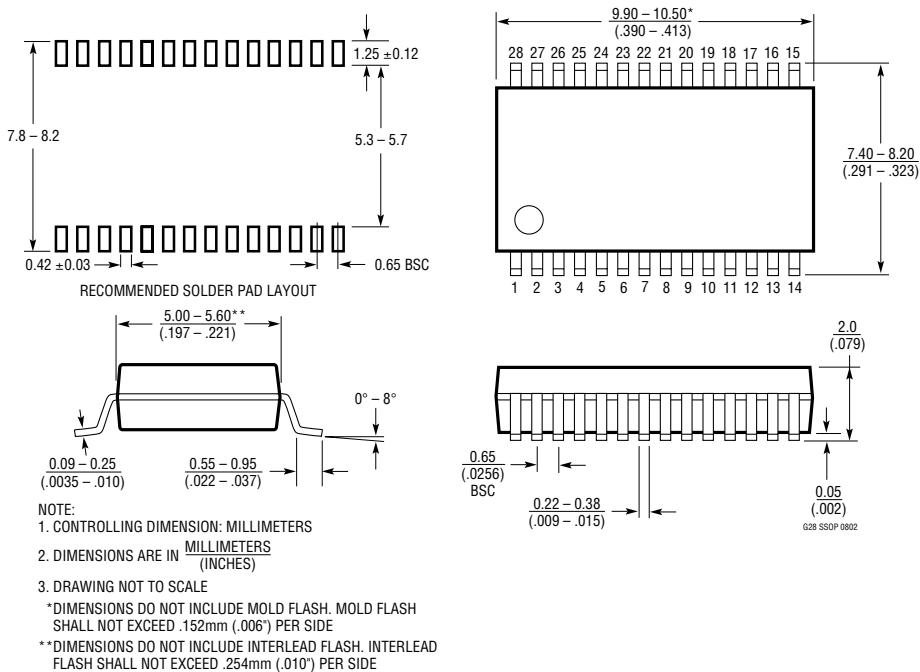

## NW Package 28-Lead PDIP (Wide .600 Inch) (Reference LTC DWG # 05-08-1520)

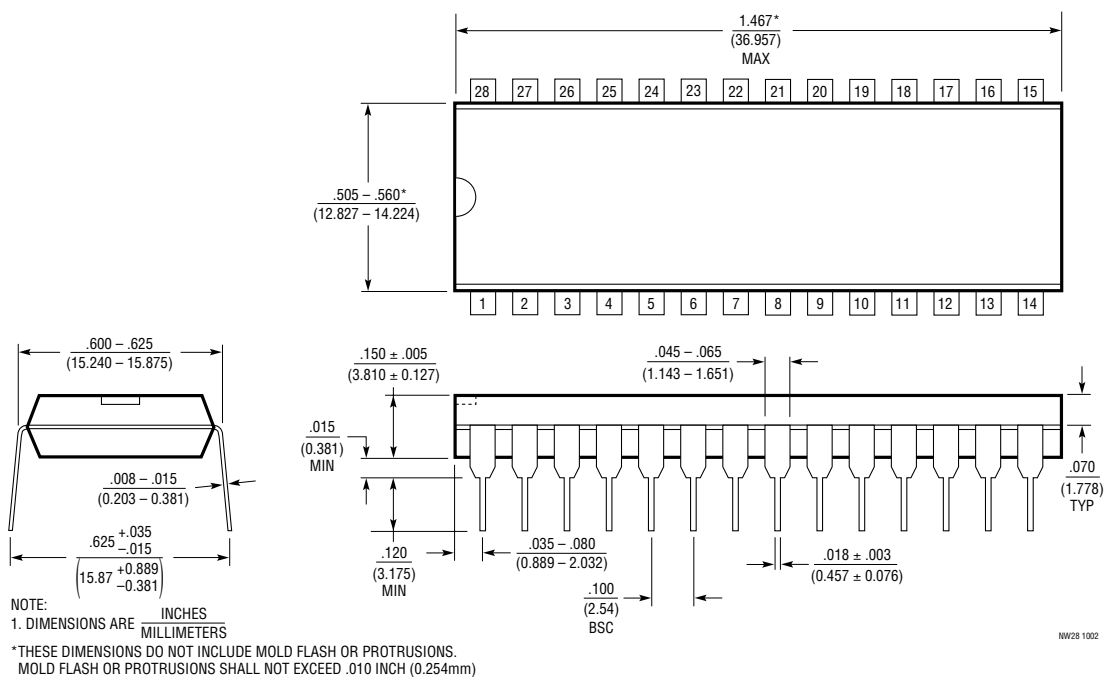

# PACKAGE DESCRIPTION

## SW Package 28-Lead Plastic Small Outline (Wide .300 Inch) (Reference LTC DWG # 05-08-1620)

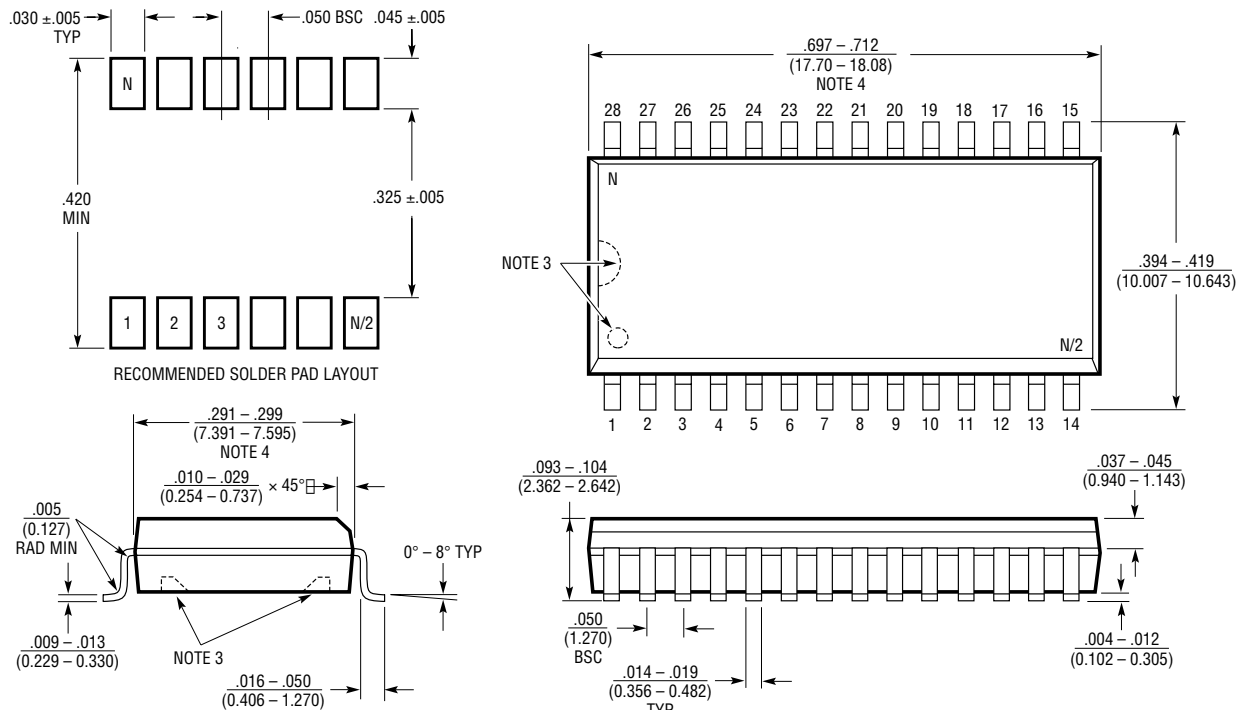

- NOTE:
1. DIMENSIONS IN  $\frac{\text{INCHES}}{\text{MILLIMETERS}}$
  2. DRAWING NOT TO SCALE
  3. PIN 1 IDENT. NOTCH ON TOP AND CAVITIES ON THE BOTTOM OF PACKAGES ARE THE MANUFACTURING OPTIONS. THE PART MAY BE SUPPLIED WITH OR WITHOUT ANY OF THE OPTIONS
  4. THESE DIMENSIONS DO NOT INCLUDE MOLD FLASH OR PROTRUSIONS. MOLD FLASH OR PROTRUSIONS SHALL NOT EXCEED  $.006"$  ( $0.15\text{mm}$ )

S28 (WIDE) 0502

## RELATED PARTS

PART NUMBER	DESCRIPTION	COMMENTS
LT <sup>®</sup> 1137A	5V, 3 Driver, 5 Receiver RS232 Transceiver	$\pm 15\text{kV}$ ESD per IEC 1000-4
LTC1327	3.3V, 3 Driver, 5 Receiver RS562 Transceiver	300 $\mu\text{A}$ Supply Current, 0.2 $\mu\text{A}$ in Shutdown
LTC1337	5V, 3 Driver, 5 Receiver RS232 Transceiver	300 $\mu\text{A}$ Supply Current, 1 $\mu\text{A}$ in Shutdown
LTC1348	3.3V to 5V, 3 Driver, 5 Receiver RS232 Transceiver	True RS232 on 3.3V, 5 Receivers Active in Shutdown