

LC2H Counters

Timers/Time Switches/Counters/Hour Meters





Panel mounting type
One-touch installation type



Panel mounting type
Installation frame type



PC board mounting type

Features

1. 8.7 mm .343 inch Character Height (previously 7 mm)

Easy-to-read character height increased from 7 mm to 8.7 mm .276 inch to .343 inch.



2. Plenty of Digits



3. Counting Speed Switchable between 2 kHz and 30 Hz

4. Panel Mounting Type Features 2 Installation Methods

Comes with very easy one-touch installation type and also installation frame type that uses the bracket on the timer/counter. Choose a method that suits the application.

5. Battery Replacement Easy on Environment

To replace battery simply remove body for the one-touch installation type, and remove battery lid for the installation frame type.

6. Screw Terminals Designed for Safety

Built in finger protection.

7. Panel Covers Replacable

(Standard color is ash gray.)
Change the panel design by replacing with a black panel cover.

8. Conforms to IP66 Protective Construction (Only installation frame type.) (Front panel surface)

9. Input Methods

- 1) Non-voltage input method
- 2) Voltage input method
- 3) Free voltage input method

10. Backlight Type Added to Series and Now 2-color Switchable (green/red)

Easy viewing even in dark places and switchable between green and red (Voltage input type).

11. Compliant with UL, c-UL and CE.

Product chart

Type		Standard type			Backlight type
		Non-voltage input type	Voltage input type (4.5 to 30 V DC)	Free voltage input type (24 to 240 V AC/DC)	Voltage input type (4.5 to 30 V DC)
Installation type	One-touch installation type	○	○	○	○
	Installation frame type	○	○	○	○
PC board mounting type		○	—	—	—

Product types

1. Panel mounting type

1) One-touch installation type

① Standard type

No. digits	Counting speed	Front reset	Input method	Part No.
8 digits	2 kHz/30 Hz switchable	Yes	Non-voltage input type	LC2H-FE-2KK
			Voltage input type (4.5 to 30 V DC)	LC2H-FE-DL-2KK
	30 Hz		Free voltage input type (24 to 240 V AC/DC)	LC2H-FE-FV-30

Note) Please ask us about types without front resetting.

② Backlight type

No. digits	Counting speed	Front reset	Input method	Part No.
8 digits	2 kHz/30 Hz switchable	Yes	Voltage input type (4.5 to 30 V DC)	LC2H-FE-DL-2KK-B

2) Installation frame type

① Standard type

No. digits	Counting speed	Front reset	Input method	Part No.
8 digits	2 kHz/30 Hz switchable	Yes	Non-voltage input type	LC2H-F-2KK
			Voltage input type (4.5 to 30 V DC)	LC2H-F-DL-2KK
	30 Hz		Free voltage input type (24 to 240 V AC/DC)	LC2H-F-FV-30

Note) Please ask us about types without front resetting.

② Backlight type

No. digits	Counting speed	Front reset	Input method	Part No.
8 digits	2 kHz/30 Hz switchable	Yes	Voltage input type (4.5 to 30 V DC)	LC2H-F-DL-2KK-B

2. PC board mounting type

No. digits	Counting speed	Front reset	Input method	Part No.
8 digits	2 kHz	No	Non-voltage input type	LC2H-C-2K-N
	30 Hz			LC2H-C-30-N

Specifications

1. Panel mounting type

Item	Type	Standard type		Backlight type	Standard type
		Non-voltage input	Voltage input		Free voltage type
No. digits		8 digits			
External power supply		Not required (built-in battery)			
Max. counting speed		2 kHz/30 Hz (Switchable by switch)			30 Hz (Note 2)
Count input	Min. input signal width (ON: OFF = 1:1)	0.25 ms/16.7 ms (Switchable by switch)			16.7 ms
	Input method (signal)	Non-voltage input using contacts or open collector connection	High level: 4.5 to 30 V DC Low level: 0 to 2 V DC		High level: 24 to 240 V AC/DC Low level: 0 to 2.4 V AC/DC
	Input impedance	When shorted: Max. 10 kΩ When open: Max. 750 kΩ	Approx. 4.7 kΩ		—
	Residual voltage	Max. 0.5 V	—		—
Reset input	Min. input signal width	200 ms			
	Input method (signal)	Non-voltage input using contacts or open collector connection	High level: 4.5 to 30 V DC Low level: 0 to 2 V DC		Non-voltage input using contacts or open collector connection
	Input impedance	When shorted: Max. 10 kΩ When open: Max. 750 kΩ	Approx. 4.7 kΩ		When shorted: Max. 10 kΩ When open: Max. 750 kΩ
	Residual voltage	Max 0.5 V	—		Max. 0.5 V
Display method		7-segment LCD		7-segment LCD With green/red backlight	7-segment LCD
Breakdown voltage (initial)		Between charged and uncharged parts: 1,000 V AC for 1 minute.			Between charged and uncharged parts: 2,000 V AC for 1 minute.
Insulation resistance (initial)		Min. 100 MΩ (measured at 500 V DC) Measurement location same as for break down voltage.			
Backlight power		—		24 V DC (±10%)	—
Protective construction (Note 3)		IEC Standard IP66 (only panel front: when using rubber gasket)			
Accessories (Note 3)		Rubber gasket, mounting bracket			
Battery life		7 years (at 25°C 77°F) Note 1			6 years (at 25°C 77°F)

Notes) 1. The value given for battery life is calculated based on continuous operation (count input signal ON/OFF = 1:1), therefore, this value is not guaranteed. Also, battery life is decreased 30% when operation is continuous with 2 kHz count inputting in 2 kHz mode.
 2. Operation is at 25 Hz when using 24 V AC.
 3. Only for installation frame type.

LC2H

2. PC board mounting type

Item		Type	PC board mounting type	
Input method			Non DC voltage input	
No. digits			8 digits	
Rated operation voltage			3 V DC	
Allowable operation voltage range			2.7 to 3.3 V DC	
Current consumption			Max. 30 μ A (max. 250 μ A during reset input)	
Max. counting speed			2 kHz	30 Hz
Count input	Min. input signal width (ON: OFF = 1:1)		0.25 ms	16.7 ms
	Input method		Non-voltage input using contacts or open collector connection	
	Input impedance		When shorted: Max. 10 k Ω When open: Max. 750 k Ω	
	Residual voltage		Max. 0.5 V	
Reset input	Min. input signal width		10 ms	
	Input method		Non-voltage input using contacts or open collector connection	
	Input impedance		When shorted: Max. 10 k Ω When open: Max. 750 k Ω	
	Residual power		Max. 0.5 V	
Break down voltage (initial)			Between charged and uncharged parts: 1,000 V AC for 1 minute.	
Insulation resistance (initial)			Min. 100 M Ω (measured at 500 V DC) Measurement location same as for break down voltage.	

3. Common

Item		Type	Panel mounting/PC board mounting types	
Vibration resistance	Functional		10 to 55 Hz (1 cycle/min.), single amplitude: 0.15 mm .006 inch (10 min. on 3 axes)	
	Destructive		10 to 55 Hz (1 cycle/min.), single amplitude: 0.375 mm .015 inch (1 hr. on 3 axes)	
Shock resistance	Functional		Min. 98 m/s ² (4 times on 3 axes)	
	Destructive		Min. 294 m/s ² (5 times on 3 axes)	
Operation temperature			-10 to +55°C +14 to +131°F (without frost or dew)	
Storage temperature			-25 to +65°C -13 to +149°F (without frost or dew)	
Ambient humidity			35 to 85% RH (non-condensing)	

Applicable standard

Safety standard	EN61010-1	Pollution Degree 2/Overvoltage Category III
EMC	(EMI)EN61000-6-4 Radiation interference electric field strength	EN55011 Group1 ClassA
	Noise terminal voltage (EMS)EN61000-6-2	EN55011 Group1 ClassA
	Static discharge immunity	EN61000-4-2 4 kV contact 8 kV air
	RF electromagnetic field immunity	EN61000-4-3 10 V/m AM modulation (80 MHz to 1 GHz) 10 V/m pulse modulation (895 MHz to 905 MHz)
	EFT/B immunity	EN61000-4-4 2 kV (power supply line)
	Conductivity noise immunity Power frequency magnetic field immunity	EN61000-4-6 10 V/m AM modulation (0.15 MHz to 80 MHz) EN61000-4-8 30 A/m (50 Hz)

Part names

1. Front reset button

This button resets the count value. It does not work when the lock switch is ON. Be aware that battery life will decrease if this switch is used frequently.

2. Lock switch (Refer to chart on right.)

Disable the front reset button.

Note) Turn ON at the LCD side (reset disabled) and OFF at the terminal block side (reset enabled).

3. Count speed switch (Refer to chart on right.)

Use this switch to switch the count speed between 30 Hz and 2 kHz. (On the non-voltage and voltage input types, 30 Hz is on the LCD side and 2 kHz is on the terminal block side. Fixed at 30 Hz for free voltage input type.)

Note) You must press the front reset button when you change the count speed switch setting. Confirm, however, that the Lock Switch is OFF (front switches operable).

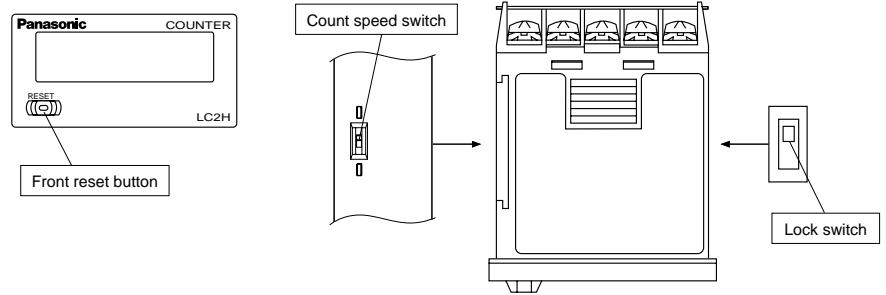

	Non-voltage input/voltage input	Free voltage input
Lock switch (Unit display 1)	(Terminal block side) ↔ (LCD side)	OFF* ↔ ON
Count speed switch (Unit display 2)	(Terminal block side) ↔ (LCD side) 2k Hz ↔ 30Hz*	— (Fixed at 30 Hz)

Notes) 1. *Default setting when shipped.
2. Make the switch setting before installing to panel.

Dimensions

1. Panel mounting type

• External dimensions

1) One-touch installation type

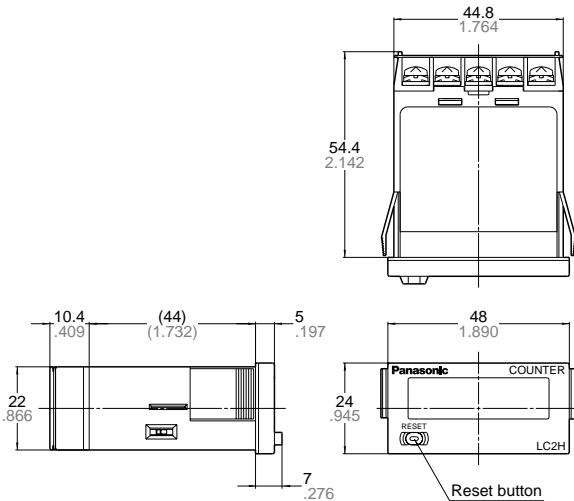

mm inch

General tolerance: ±1.0 ±.039

• Panel installation diagram

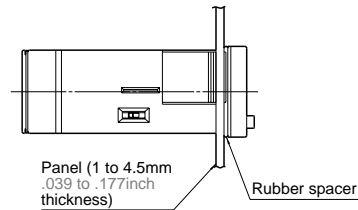

Note) When installing to a 4.5 mm .177 inch thick panel, remove the rubber spacer first.

When installing the one-touch installation type model, make sure that the installation spring does not pinch the rubber gasket.

To prevent the installation spring from pinching the rubber gasket:

1. Set the rubber gasket on both ends of the installation spring (left and right).
2. Confirm that the installation spring is not pinching the rubber gasket, and then insert and fix the installation spring in place from the rear of the timer unit.

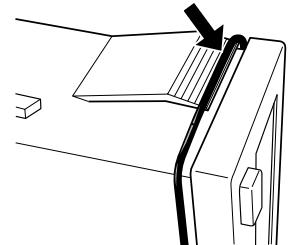

LC2H

2) Installation frame type

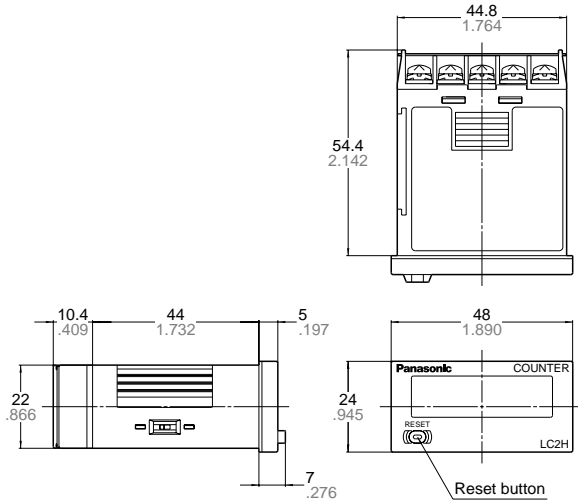

• Panel mounting diagram

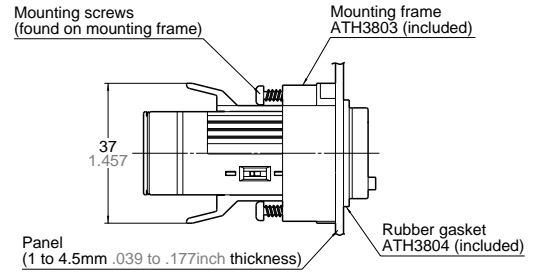

• Panel cut-out dimensions

The standard panel cut-out is shown below.
Use the mounting frame (ATH3803) and the rubber packing (ATH3804).
(Only installation frame type.)

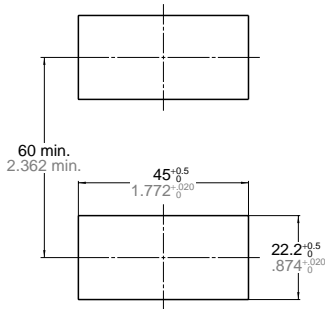

• For connected installation (sealed installation) (Only installation frame type.)

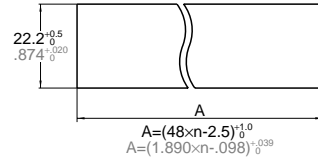

Notes) 1. Suitable installation panel thickness is 1 to 4.5 mm .039 to .177 inch.
2. Waterproofing will be lost when installing repeatedly (sealed installation).

• Terminal layout and wiring diagrams

1) Standard type

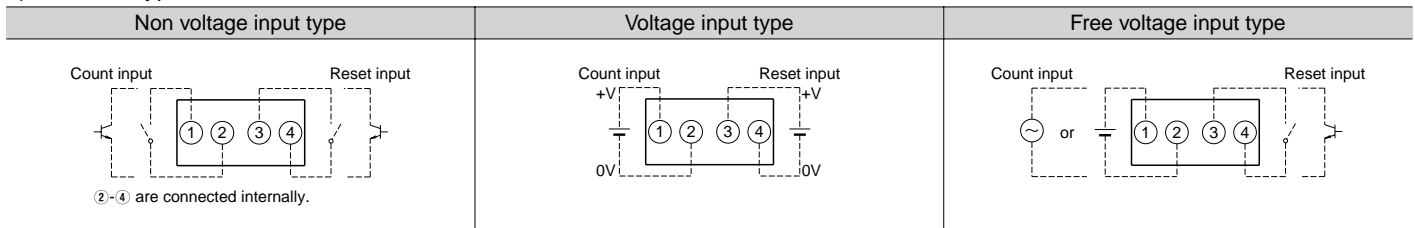

2) Backlight type

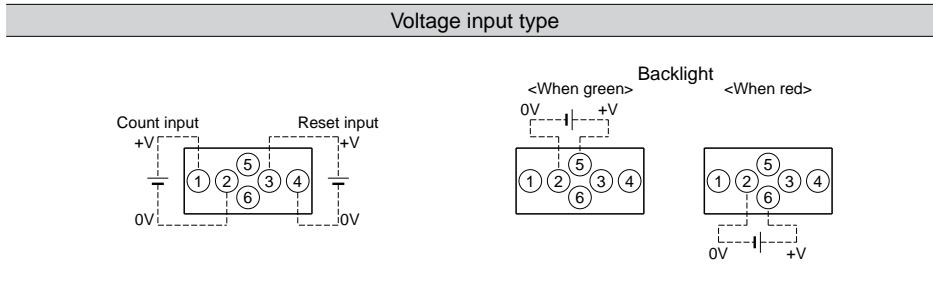

2. PC board mounting type

General tolerance: ±1.0 ±.039 mm inch

• External dimensions

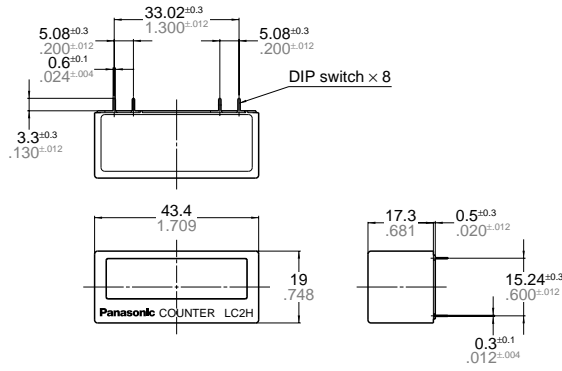

PC board pattern (BOTTOM VIEW)

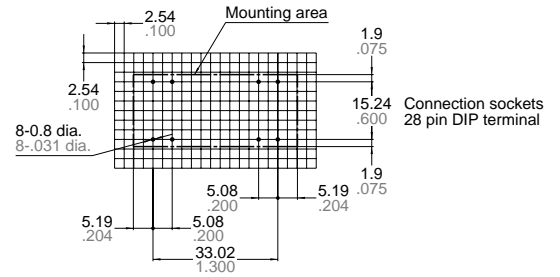

General tolerance: ±0.1 ±.004

• Terminal layout and wiring diagrams

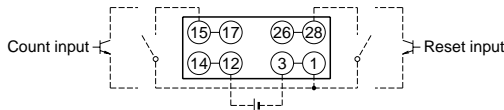

①-③, ⑫-⑭, ⑮-⑰ and ⑳-㉔ are connected internally.
An external power supply is required.

Note: The AXS212811K is recommended as a compatible connection socket.

Input method

1. Standard type

Non-voltage input type			
Panel mounting type		PC board mounting type	
Contact input	Transistor input NPN transistor	Contact input	Transistor input NPN transistor

Notes) 1. When using contact input, since current flow is small from terminals ① and ③ on the panel mounting type and terminals ⑮ to ⑰ and ⑳ to ㉔ on the PC board mounting type, please use relays and switches with high contact reliability.
2. When using transistor input, use the following as a guide for which transistors (Tr) to use for inputting. (Collector withstand voltage ≥ 50 V, leakage current < 1 μA)

Voltage input type			Free voltage input type
Contact input	Transistor input		
	NPN transistor	PNP transistor	

Notes) 1. ② and ④. (The input and reset circuits are functionally insulated.)
2. When using transistor (Tr) input, use the right as a guide. (Collector withstand voltage ≥ 50 V, leakage current < 1 μA)
3. Be aware that the application of voltage that exceeds the voltage range of the H level to the count input terminal, and the application of voltage to the reset input terminal, can cause damage to the internal elements.

LC2H

2. Backlight type

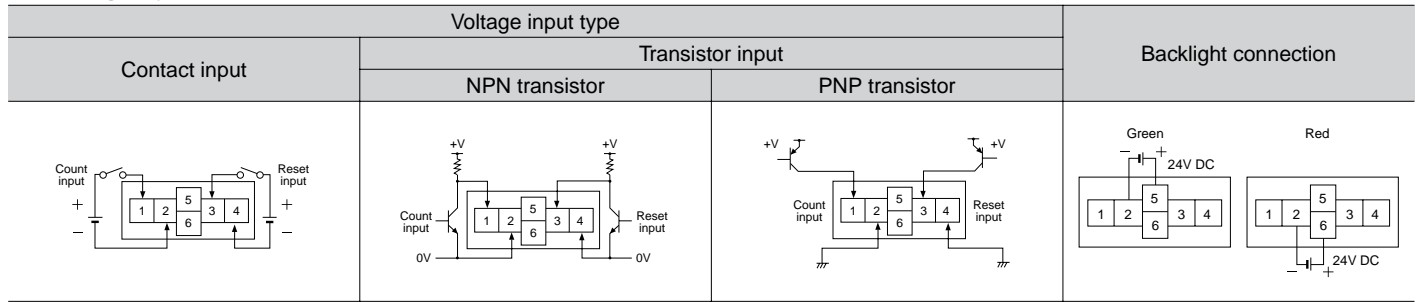

- Notes) 1. Do not reverse the polarities when connecting the DC voltage for the backlight.
 2. ② and ④. (The input and reset circuits are functionally insulated.)
 3. When using transistor (Tr) input, use the right as a guide. (Collector withstand voltage ≥ 50 V, leakage current $< 1 \mu\text{A}$)
 4. Be aware that the application of voltage that exceeds the voltage range of the H level to the count input terminal, and the application of voltage to the reset input terminal, can cause damage to the internal elements.

Explanation of operation

- Counting takes place when the count input signal is ON.
- Counting resumes again when the count value reaches 99999999 (full scale value) and then returns to "0" with a new count input.
- No measurement takes place when a reset is input.
 - When reset is ON, resetting takes place and the count becomes "0".
 - Press the front reset button when you want to reset manually (only panel installation type).

Note) Be aware that battery life will decrease if the count input or reset input are left ON.

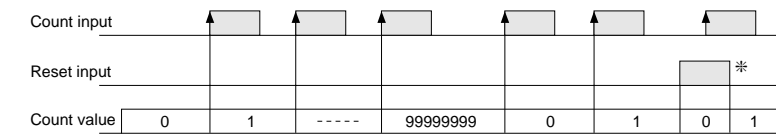

Note) *Count becomes "1" when the reset input is turned OFF while the count signal is being input.

Cautions for use

1. Non-voltage input type

For both panel mounting and PC board mounting types

1) Never apply voltage to the non-voltage input type. This will damage the internal elements. Also, since there is a possibility of erroneous operation, do not connect in parallel the inputs of a non-voltage input type and another counter from a single input signal.

2) Since the current flow is very small from the count input and reset input terminals (① and ③ on the panel mounting type and terminals ⑮ to ⑰ and ⑳ to ㉓ on the PC board mounting type) please use relays and switches with high contact reliability.

3) When inputting with an open collector of a transistor, use a transistor for small signals in which ICBO is 1 μA or less and always input with no voltage.

4) When wiring, try to keep all the input lines to the count and reset inputs as short as possible and avoid running them together with high voltage and power transmission lines or in a power conduit. Also, malfunctions might occur if the floating capacitance of these wires exceeds 500 pF (10 m 32.808 ft. for parallel wires of 2 mm²). When using 2 kHz mode, use with a wiring floating capacitance of 120 pF (3 m 9.843 ft. for parallel wires of 2 mm²). In particular, when using shielded wiring, be careful of the capacitance between wires.

PC board mounting type

1) For external power supply use manganese dioxide or lithium batteries (CR type: 3V).

2) Always reset after external power is applied and confirm that the display reads "0".

3) Make the wiring from the battery to the counter unit as short as absolutely possible. Also, be careful of polarity.

4) Calculate battery life with the following formula.

$$t = A/I$$

t: battery life [h]

I: LC2H current consumption [mA]

A: battery capacity until minimum operation voltage is reached [mAh]

5) Hand solder to the lead terminal. Do not dip solder. With the tip of the soldering iron at 300°C 572°F perform soldering within 3 seconds (for 30 to 60 W soldering iron).

2. Voltage input type

1) Be aware that applying more than 30 V DC to count input terminals ① and ②, and reset input terminals ③ and ④ will cause damage to the internal elements.

2) For external resetting use H level (application of 4.5 to 30 V DC) between reset terminals ③ and ④ of the rear terminals. In this case, connect + to terminal ③ and - to terminal ④. This is the valid polarity; therefore, the counter will not work if reversed.

3) When wiring, try to keep all the input lines to the count and reset inputs as short as possible and avoid running them together with high voltage and power transmission lines or in a power conduit. Also, malfunctions might occur if the floating capacitance of these wires exceeds 500 pF (10 m 32.808 ft. for parallel wires of 2 mm²).

3. Free voltage input type

1) Use count input terminals ① and ② for free voltage input and reset terminals ③ and ④ for non-voltage input.

2) Be aware that the application of voltage that exceeds the voltage range of the H level to the count input terminal, and the application of voltage to the reset input terminal, can cause damage to the internal elements.

3) Since the current flow is very small from reset input terminal ③, please use relays and switches with high contact reliability.

4) When inputting a reset with an open collector of a transistor, use a transistor for small signals in which ICBO is 1 μA or less and always input with no voltage.

5) To reset externally, short reset input terminals ③ and ④ on the rear.

6) Input uses a high impedance circuit; therefore, erroneous operation may occur if the influence of induction voltage is present. If you plan to use wiring for the input signal that is 10 m or longer (wire capacitance 120 pF/m at normal temperature), we recommend the use of a CR filter or the connection of a bleeder resistor.

4. How to reset multiple panel mounting type counters all at once (input is the same for count)

Non-voltage input type

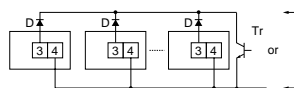

- Notes) 1. Use the following as a guide for choosing transistors used for input (Tr).
Leakage current < 1 μA
2. Use as small a diode (D) as possible in the forward voltage so that the voltage between terminals 3 and 4 during reset input meets the standard value (0.5 V).
(At IF = 20 μA, forward voltage 0.1 and higher.)

Voltage input type

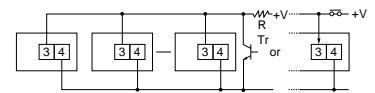

Note) Make sure that H (reset ON) level is at least 4.5 V.

5. Backlight luminance

To prevent varying luminance among backlights when using multiple Backlight types, please use the same backlight power supply.

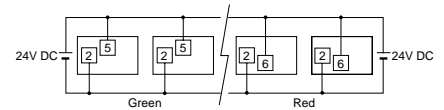

6. Environment for use

1) Ambient conditions

- Overvoltage category II, pollution level 2
- Indoor use
- Acceptable temperature and humidity range: -10 to +55°C, 35 to 85%RH (with no condensation at 20°C)
- Under 2000 m elevation

2) Use the main unit in a location that matches the following conditions.

- There is minimal dust and no corrosive gas.
- There is no combustible or explosive gas.
- There is no mechanical vibration or impacts.
- There is no exposure to direct sunlight.
- Located away from large-volume electromagnetic switches and power lines with large electrical currents.

3) Connect a breaker that conforms to EN60947-1 or EN60947-3 to the voltage input section.

4) Applied voltage should be protected with an overcurrent protection device (example: T 1A, 250 V AC time lag fuse) that conforms to the EN/IEC standards. (Free voltage input type)



Features



1. Preset function equipped in half size (24 × 48 mm 0.945 × 1.890 inch).
2. Display has backlight for instant recognition.

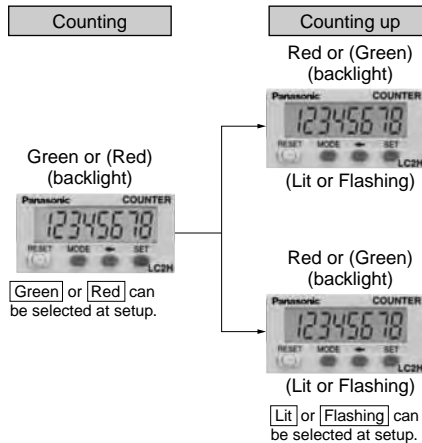

3. 8.7 mm 0.343 inch Character Height (previously 7 mm 0.276 inch)
Easy-to read character height increased from 7 mm to 8.7 mm 0.276 inch to 0.343 inch.



4. Plenty of Digits



5. Counting Speed Switchable between 30 Hz and 5 kHz
6. Conforms to IP66 Protective Construction (Front panel surface)
Weatherproofing supported by using optional mounting frame and rubber gasket
7. Includes reassuring lock mode and lock switch to prevent erroneous operation.
8. Screw terminals are constructed to protect fingers to ensure safety.
9. Compliant with UL, c-UL and CE.

Product types

No. digits	Counting speed	Output mode	Output	Operating voltage	Part No.
8 digits	30 Hz/5 kHz switchable	<ul style="list-style-type: none"> • Maintain output/hold count • Maintain output/over count • One shot/over count • One shot/recount 	Transistor (1a)	24 V DC	LC2HP-FEW-B-DC24V
Options		Mounting frame	Use for waterproofing (front panel surface)		ATH3803
		Rubber gasket			ATH3804

Note: Mounting frame and rubber gasket are not included.

Specifications

Item		Descriptions
Rating	Rated operating voltage	24 V DC
	Rated power consumption	Max. 1.5 W
	Rated control capacity	100 mA 30 V DC
	Input mode	Addition/Subtraction (selectable by front switch)
	Max. counting speed	30 Hz/5 kHz (selectable by slide switch on side)
	Counting input	Min. input signal width: 16.7 ms at 30 Hz/0.1 ms at 5 kHz, ON time : OFF time = 1 : 1
	Reset input	Min. input signal width: Min. 30 ms
	Input signal	<ul style="list-style-type: none"> • Non-voltage input using contacts or open-collector connection • Input impedance; when shorted: Max. 1 kΩ, when open: Min. 100 kΩ • Residual voltage: Max. 2 V
	Output mode	<ul style="list-style-type: none"> • Maintain output/hold count • One shot/over count • Maintain output/over count • One shot/recount (Selectable by front switch)
	Display method	7-segment LCD (Switch between red and green for backlight, and between lit and flashing for count up.)
	Digit	-9999999 to 99999999 (-7 digits to +8 digits) (0 to 99999999 for preset value)
Memory	EEP-ROM (Overwriting times: 10 ⁵ operations or more)	
Contact arrangement		1 Form A (Open collector)
Electrical life (contact)		10 ⁷ operations (at rated control voltage)
Electrical	Allowable operating voltage range	85 to 110% of rated operating voltage
	Break down voltage (Initial value)	Between input and output: 1,500 V AC, for 1 min.
	Insulation resistance (Initial value)	Between input and output: 100 M Ω (at 500 V DC)
Mechanical	Functional vibration resistance	10 to 55 Hz (1 cycle/min), Single amplitude: 0.15 mm (10 min. on 3 axes)
	Destructive vibration resistance	10 to 55 Hz (1 cycle/min), Single amplitude: 0.375 mm (1 hr. on 3 axes)
	Functional shock resistance	Min. 98 m/s ² (4 times on 3 axes)
	Destructive shock resistance	Min. 294 m/s ² (5 times on 3 axes)
Operating conditions	Operation temperature	-10 to 55°C +14 to +131°F (without frost or dew)
	Storage temperature	-25 to +65°C -13 to +149°F (without frost or dew)
	Ambient humidity	30 to 85% RH (at 25°C 77°F, non-condensing)
Protective construction		IP66 (front panel with mounting bracket and rubber gasket)

* The factory default preset value is set to 1000000.

Applicable standard

EMC	(EMI)EN61000-6-4 Radiation interference electric field strength	EN55011 Group1 ClassA
	Noise terminal voltage	EN55011 Group1 ClassA
	(EMS)EN61000-6-2 Static discharge immunity	EN61000-4-2 4 kV contact 8 kV air
	RF electromagnetic field immunity	EN61000-4-3 10 V/m AM modulation (80 MHz to 1 GHz) 10 V/m pulse modulation (895 MHz to 905 MHz)
	EFT/B immunity	EN61000-4-4 2 kV (power supply line) 1 kV (signal line)
	Conductivity noise immunity	EN61000-4-6 10 V/m AM modulation (0.15 MHz to 80 MHz)
	Power frequency magnetic field immunity	EN61000-4-8 30 A/m (50 Hz)

LC2H

Part names

1. Front reset key

This key resets the count value. It does not work when the lock switch is ON.

2. Mode key

Use to switch between each mode.

3. Setting key

Used to set digits of preset values or set each mode.

4. Set key

Use to set preset values or to switch between modes.

5. Lock switch



Disable the operation of the front panel reset key and the mode key. With the lock switch on, Lock is displayed for about two seconds when the reset key or mode switch is operated.

6. Count speed switch

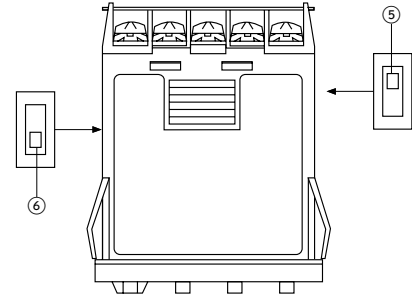
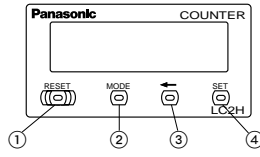
Use this switch to switch the count speed between 30 Hz and 5 kHz.



※: Default setting when shipped.

⑤	Lock switch (unit display 1)	(Terminal block side) ↑↓ (LCD side)	 OFF※ ↑↓ ON
⑥	Count speed switch (unit display 2)	(Terminal block side) ↑↓ (LCD side)	 5kHz ↑↓ 30Hz※

Notes: 1. Make the switch setting before installing to panel.

2. Please turn the power off if you change the setting of the count speed switch when the power is on. The setting will become valid when the power is turned back on.

Dimensions

mm inch

General tolerance: $\pm 1.0 \pm 0.039$

• External dimensions

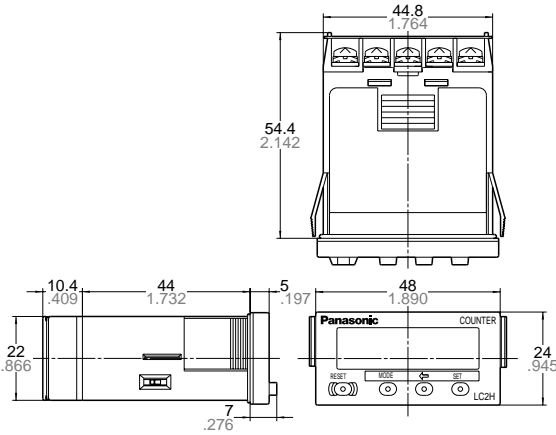

When installing the one-touch installation type model, make sure that the installation spring does not pinch the rubber gasket.

To prevent the installation spring from pinching the rubber gasket:

1. Set the rubber gasket on both ends of the installation spring (left and right).
2. Confirm that the installation spring is not pinching the rubber gasket, and then insert and fix the installation spring in place from the rear of the timer unit.

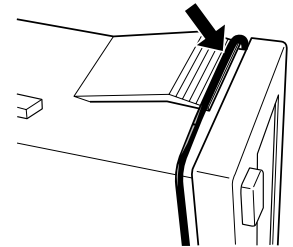

• Panel cut out dimensions

The standard panel cut out is shown below.

Use the mounting bracket (ATH3803) and the rubber gasket (ATH3804).
(Only installation frame type)

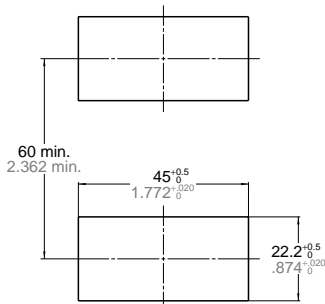

• When installing repeatedly (sealed installation) (Only installation frame type)

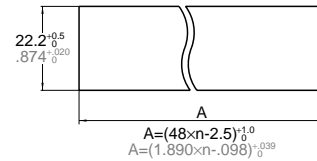

- Notes: 1. Suitable installation panel thickness is 1 to 4.5 mm 0.039 to 0.177 inch.
2. Waterproofing will be lost when installing repeatedly (sealed installation).

How to set

1. Preset value setting mode

This is the mode for setting preset values.



1) Pressing the MODE key takes you to the preset value setting mode.

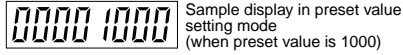

2) Pressing the setting key moves the flashing digit left by one. Following the highest digit it returns to the lowest digit and each time the digit setting key is pressed it moves one to the left.

3) Pressing the set key increases the value by one. (After 9 it returns to 0 and then changes to 1, 2, 3, etc.)

4) Pressing the front panel reset key sets the displayed preset value and returns you to the regular operation mode.

5) In the preset value setting mode if you do not operate the digit setting key or the set key for ten seconds or more you will be returned to regular operation. In this case the preset value will not change.

2. Lock mode

This mode prohibits everything except the preset value setting mode.



1) Pressing the set key while holding down the mode key takes you to the lock mode.

2) The display reads “Un-Lock” after entering the lock mode (initial setting).

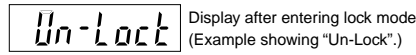

3) Pressing the setting key changes the display between “ Lock” and “Un-lock”.

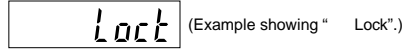

4) Pressing the front panel reset key sets the content displayed and returns you to regular operation mode.

Note: You will not be returned to regular operation mode if you do not press the front panel reset key.

5) When the lock mode display reads “ Lock”, you will not be able to move to the backlight setting mode, the input setting mode, or the output setting mode.

3. Backlight setting mode

This is the mode for setting the backlight during count up.

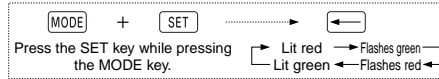

1) Pressing the SET key two times while holding down the MODE key takes you to the backlight setting mode.

2) The display in the backlight setting mode reads “ LEd”



3) The LED backlight will be red (initial setting).

4) The backlight changes from flashing green to flashing red to lit green and to lit red with each press of the setting key.

5) Pressing the front panel reset key sets the current backlight color and returns you to regular operation mode.

Note: You will not be returned to regular operation mode if you do not press the front panel reset key.

4. Input setting mode

This is the mode for setting addition or subtraction.

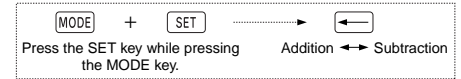

1) Pressing the SET key three times while holding down the MODE key takes you to the input setting mode.

2) The display after entering the input setting mode reads “ UP” (initial setting).



3) Pressing the setting key changes the display to “dn” (subtraction) and pressing it again changes it to “UP” (addition). The display alternates between “dn” and “UP”.

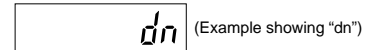

4) Pressing the front panel reset key sets the content displayed and returns you to regular operation mode.

Note: You will not be returned to regular operation mode if you do not press the front panel reset key.

LC2H

5. Output setting mode

This sets the operation mode.

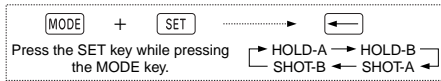

1) Pressing the SET key four times while holding down the MODE key takes you to the output setting mode.

2) The display reads "HoLd-A" (initial setting) after entering the output setting mode.

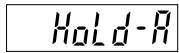

3) Pressing the setting key causes the display to change as follows:

HOLD-B (Output maintain/over count I)



SHOT-A (One shot/over count)



SHOT-B (One shot/recount I)



HOLD-A (Output maintain/hold count)

4) Pressing the front panel reset key sets the display content and returns you to regular operation mode.

Note: You will not be returned to regular operation mode if you do not press the front panel reset key.

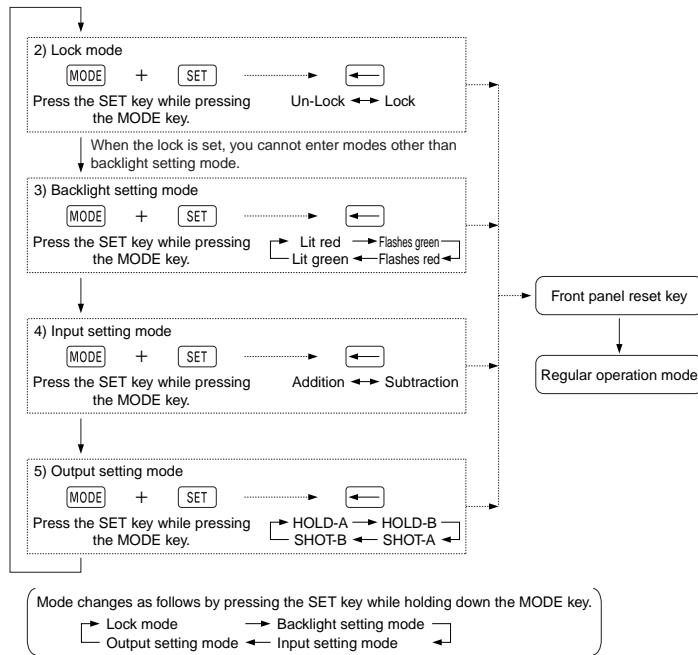

Please be aware that after doing a front panel reset key and returning to regular operation mode, the preset values, count value and output will be as shown in this table.

	Preset value	Count value	Output change
Lock mode	×	×	×
Backlight setting mode	×	×	×
Input setting mode	×	Addition: "0" Subtraction: "Preset value"	ON→OFF
Output setting mode	×	Addition: "0" Subtraction: "Preset value"	ON→OFF

Note: "x" sign: No change

Changing the preset value

1. It is possible to change the preset value even during counting. However, be aware of the following points.

1) If the preset value is changed to less than the count value with counting set to the addition direction, counting will continue until it reaches full scale, returns to zero, and then reaches the new preset value. If the preset value is changed to a value above the count value, counting will continue until the count value reaches the new preset value.

2) Suppose that the counter is preset to count down. Whether a preset count down value is smaller or larger than the count value, the counter counts down to "0 (zero)".

2. If the preset value is changed to "0", the counter will not complete count-up. It starts counting up when the counting value comes to "0 (zero)" again.

1) Addition (up-count) input when counting is set to the addition direction, counting will continue until full scale is reached, return to zero, and then complete count-up.

2) Subtraction (down-count) input when counting is set to the subtraction direction, counting will continue until full scale "-9999999" is reached, and then the display will change to " ".

Compliance with the CE marking

• EMC Directive (89/336/EEC)

The LC2H Preset Counter conforms to the EMC Directive as a simple counter.

Applicable standards: EN61000-6-4, EN61000-6-2

Operation mode

Output mode	Operation	Example when input mode is either addition or Subject:ubtraction
Output maintain/ hold count HOLD-A	Output control is maintained after count-up completion and until resetting. During that time, the count display does not change from that at count-up completion.	<p>Output: OFF → ON</p> <p>Counting able/unable: ← Able → Unable</p> <p>Addition: 0 1 2 3 4 .. n-1 n</p> <p>Subtraction: n n-1 n-2 n-3 n-4 .. 1 0</p> <p>n: Preset value</p>
Output maintain/ over count I HOLD-B	Output control is maintained after count-up completion and until resetting. However, counting is possible despite completion of count-up.	<p>Output: OFF → ON</p> <p>Counting able/unable: ← Able →</p> <p>Addition: 0 1 2 3 .. n-2 n-1 n n+1 n+2 n+3</p> <p>Subtraction: n n-1 n-2 n-3 .. 2 1 0 -1 -2 -3</p> <p>n: Preset value</p>
One shot/ over count SHOT-A	Output control is maintained after count-up completion for a fixed time (approx. 1 sec.). Counting is possible despite completion of count-up.	<p>Output: OFF → ON (One shot pulse width: approx. 1 sec.)</p> <p>Counting able/unable: ← Able →</p> <p>Addition: 0 1 2 3 .. n-2 n-1 n n+1 n+2 n+3</p> <p>Subtraction: n n-1 n-2 n-3 .. 2 1 0 -1 -2 -3</p> <p>n: Preset value</p>
One shot/ recount I SHOT-B	Output control is maintained after count-up completion for a fixed time (approx. 1 sec.). Counting is possible despite completion of count-up. However, reset occurs simultaneous with completion of count-up. While output is being maintained, restarting of the count is not possible.	<p>Output: OFF → ON (One shot pulse width: approx. 1 sec.)</p> <p>Counting able/unable: ← Able →</p> <p>Addition: 0 1 2 3 .. n-1 0 1 2 3 4</p> <p>Subtraction: n n-1 n-2 n-3 .. 1 n n-1 n-2 n-3 n-4</p> <p>n: Preset value</p>

LC2H

Cautions for use

1. Input and output connection

1) Input connection

(1) Contact input

Use highly reliable metal plated contacts. Since the contact's bounce time leads directly to error in the count value, use contacts with as short a bounce time as possible. In general, select input to have a maximum counting speed of 30 Hz.

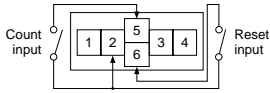

(2) Non-contact input (Transistor input)

Connect with an open collector. Use transistors whose characteristics satisfy the criteria given below.

VCEO = Min. 20 V

IC = Min. 20 mA

ICBO = Max. 6 μ A

Also, use transistors with a residual voltage of less than 2 V when the transistor is on.

* The short-circuit impedance should be less than 1 k Ω .

(When the impedance is 0 Ω , the current coming from the count input terminal is approximately 5 mA and from the reset input terminal is approximately 1.5 mA.)

Also, the open-circuit impedance should be more than 100 k Ω .

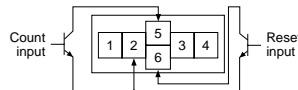

(3) Input wiring

When wiring, use shielded wires or metallic wire tubes, and keep the wire lengths as short as possible.

2) Output connection

Since the transistor output of counter is insulated from the internal circuitry by a photo-coupler, it can be used as an NPN output or PNP (equal value) output.

As NPN output

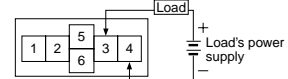

As PNP output

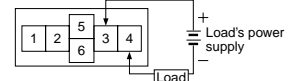

2. Self-diagnosis function

If a malfunction occurs, one of the following displays will appear.

Display	Contents	Output condition	Restoration procedure	Preset values after restoration
Err-00	Malfunctioning CPU	OFF	Enter front reset key or restart counter	The preset value at start-up before the CPU malfunction occurred.
Err-01	Malfunctioning memory*			0

* Includes the possibility that the EEPROM's life has expired.

3. Terminal connection

1) When wiring the terminals, refer to the terminal layout and wiring diagrams and be sure to perform the wiring properly without errors.

An external power supply is required in order to run the main unit.

Power should be applied between terminals (1) and (2). Terminal (1) acts as the positive connection and terminal (2) as the negative.

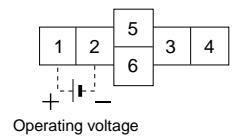

2) After turning the counter off, make sure that any resulting induced voltage or residual voltage is not applied to power supply terminals (1) through (2). (If the power supply wire is wired parallel to the high voltage wire or power wire, an induced voltage may be generated at the power supply terminal.)

3) Have the power supply voltage pass through a switch or relay so that it is applied at one time.

PRECAUTIONS IN USING THE LC2H SERIES

Cautions for use

1. Insulation sheet

Before using a panel mounting type, please pull and remove the insulation sheet from the side of the product in the direction of the arrow.

In consideration that the product might be stored for long periods without being used, an insulation sheet is inserted before shipping. Remove the insulation sheet and press the front reset button.

• LC2H total counter (one-touch installation type)

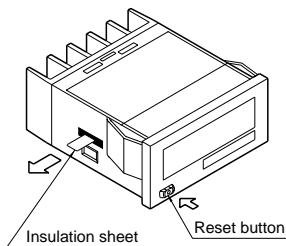

• LC2H total counter (installation frame type)

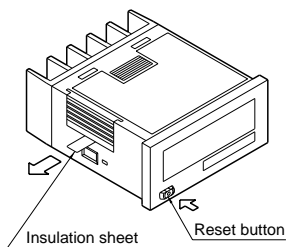

2. Waterproof construction

• LC2H total counter (installation frame type)

The operation part of the panel installation type (installation frame type) is constructed to prevent water from entering the unit and a rubber gasket is provided to prevent water from entering the gap between the unit and the panel cutout.

There must be sufficient pressure applied to the rubber gasket to prevent water from entering.

Be sure to use the mounting reinforcement screws when installing the mounting frame (ATH3803).

Note: The one-touch installation type is not waterproof.

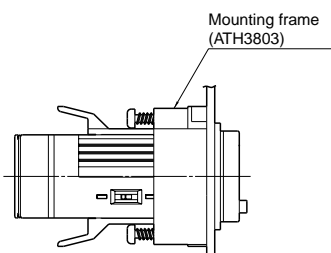

• LC2H preset counter

1) The front plate will not be waterproof when this product is installed on a panel. To make the front plate waterproof, please install the following.

When using the waterproof type (IP66: panel front only), install the counter to the front plate with mounting frame ATH3803 (sold separately) and rubber gasket ATH3804 (sold separately). Be sure to tighten using mounting screws.

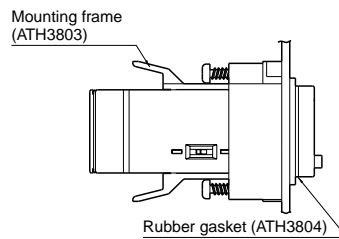

When installing the mounting frame and rubber gasket please remove the pre-attached o-ring.

2) Panel installation order

- (1) Remove o-ring.
- (2) Place rubber gasket.
- (3) Insert counter into panel.
- (4) Insert mounting frame from the rear.
- (5) Secure with mounting screws (two locations)

3. Do not use in the following environments

- 1) In places where the temperature changes drastically.
- 2) In places where humidity is high and there is the possibility of dew. (When dew forms the display may vanish and other display errors may occur.)

4. Conditions of use

- 1) Do not use on places where there is flammable or corrosive gas, lots of dust, presence of oil, or where the unit might be subject to strong vibrations or shocks.
- 2) Since the cover is made of polycarbonate resin, do not use in places where the unit might come into contact with or be exposed to environments that contain organic solvents such as methyl alcohol, benzene and thinner, or strong alkali substances such as ammonia and caustic soda.

5. Cautions regarding battery replacement

- 1) Remove wiring before replacing the battery. You may be electrocuted if you come into contact to a part where high voltage is applied.
- 2) Make sure you are not carrying a static electric charge when replacing the battery.
- 3) Battery replacement procedure
For LC2H total counter (one-touch installation type)
 - (1) Remove the up/down hook of the case using a tool.
 - (2) Pull the unit away from the case.
 - (3) Remove the battery from the side of the unit. Do not touch the display or other parts.
 - (4) Before inserting wipe clean the surface of the new battery.
 - (5) Insert the new battery with the "+" and "-" sides in the proper position.
 - (6) After replacing the battery, return the unit to the case. Verify that the hook of the case has properly engaged.
 - (7) Before using, press the reset button on the front.

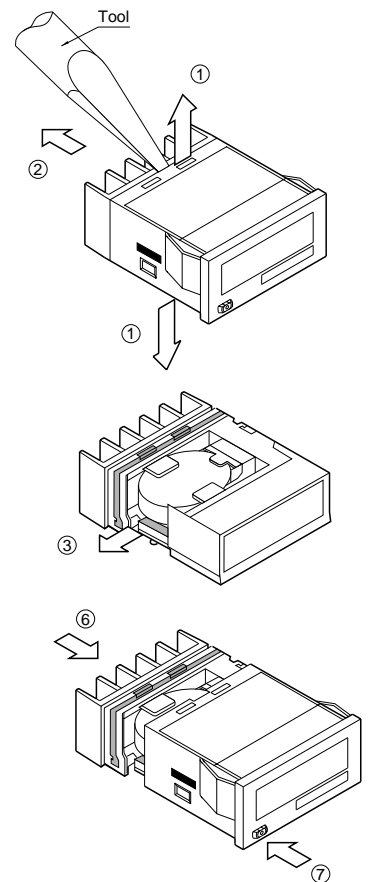

LC2H

For LC2H total counter
(installation frame type)

- (1) Remove the battery cover from the case.
- (2) Remove the battery from the side of the case. The battery will come loose if you put the battery side face down and lightly shake the unit.
- (3) Before inserting wipe clean the surface of the new battery.
- (4) Insert the new battery with the "+" and "-" sides in the proper position.
- (5) After replacing the battery, return the battery cover to the case. Verify that the hook of the battery cover is properly engaged.
- (6) Before using press the reset button on the front.

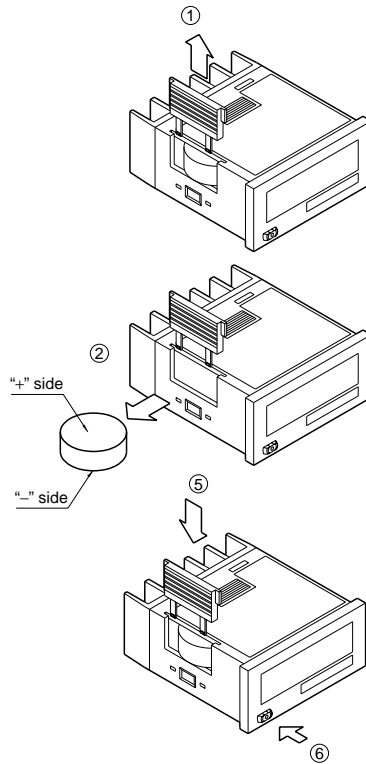

6. Terminal connection

Tighten the terminal screws with a torque of 0.8 N·cm or less.

Options

1. Accessories (for LC2H total counter)

Panel cover (black)

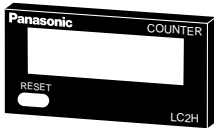

Part No.: AEL3801

You can change the design of the front panel by replacing it with this black panel cover. The counter comes with an ash gray panel cover as standard.

Note: No panel cover accessory (black) is available for the LC2H preset counter.

2. Lithium battery (3 V)



Part No.: ATH3802

Packaged with the LC2H (excluding the PC board mounting type).

Warning

- Make sure the "+" and "-" polarities are positioned correctly.
- Do not throw the old battery into a fire, short circuit it, take it apart, or allow it to come into contact with heat.
- The battery is not rechargeable.

3. Installation parts

Mounting frame

(Suitable for installation frame type LC2H total counter and LC2H preset counter)

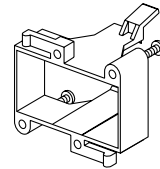

Part No.: ATH3803

Packaged with the mounting bracket type LC2H total counter

Rubber gasket

(Suitable for installation bracket type LC2H total counter and LC2H preset counter)









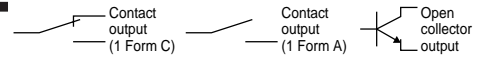







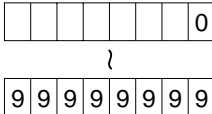
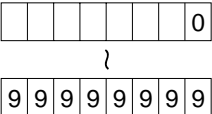
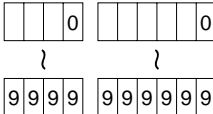
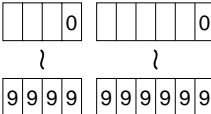
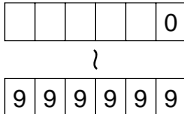

Part No.: ATH3804

Packaged with the mounting bracket type LC2H total counter

COUNTERS SELECTOR CHART



Classification	Electronic counters				
Name of product	LC2H Counter	LC2H Counter	LC4H-L Counter	LC4H-S Counter	LC4H-W Counter
Type	Total counter	Preset counter	Preset counter	Preset counter	Preset counter
Input mode/Input method	UP type	UP, DOWN type	UP, DOWN, and DIR (multi-mode)/DIP switch	UP, DOWN, and DIR (multi-mode)/DIP switch	UP, DOWN, and DIR (multi-mode) 2 modes selectable/DIP switch
Appearance	Flush mounting type  PC board mounting type  AEL3	 AEL3	 4-digit display  6-digit display	 4-digit display  6-digit display	 LC4H-W
Features	8.7 mm tall 8-digit display Bright 2-color back light	8.7 mm tall 8-digit display Preset function equipped in half size Display has backlight for instant recognition	Bright and easy-to-read display Simple operation Short body Conforms to IP66's weather resistant standards	Bright and easy-to-read display Simple operation Pre-scale function Built-in power supply for high-capacity sensor (100 to 240 V AC type) Conforms to IP66's weather resistant standards	Bright and easy-to-read display Simple operation Upper and lower limit settings are available. Conforms to IP66's weather resistant standards
Rated operating voltage	Flush mounting type: Unnecessary (Built-in battery) PC board mounting type: 3 V DC (Battery in externally installed)	24 V DC	100 to 240 V AC 24 V AC, 12 to 24 V DC	100 to 240 V AC	100 to 240 V AC 24 V AC 12 to 24 V DC
Number of digits (counter capacity)	8-digit  } 9 9 9 9 9 9 9 9	8-digit  } 9 9 9 9 9 9 9 9	4-digit 6-digit  } 9 9 9 9 9 9 9 9	4-digit 6-digit  } 9 9 9 9 9 9 9 9	6-digit  } 9 9 9 9 9 9
Counter/Indication	Zero-suppress function (LCD)	Zero-suppress function (LCD)	7-segment LCD Counter value (backlight red LED) Setting value (backlight yellow LED)	7-segment LCD Counter value (backlight red LED) Setting value (backlight yellow LED)	7-segment LCD Counter value (backlight red LED) Setting value (backlight yellow LED)
Counting speed	Flush mounting type: 2kHz/30Hz (Changeable by a switch) PC board mounting type: 2kHz/30Hz (Different type)	30Hz/5kHz (switchable)	30Hz/5kHz	30Hz/5kHz	30Hz/5kHz
Input	Counting (signal) input and reset input • Input by short-circuiting or opening contacts • Open collector input • Voltage input	Counting (signal) input and reset input • Input by short-circuiting or opening contacts • Open collector input	2-input (multi-mode) and reset input • Input by short-circuiting or opening contacts. • Open collector input	2-input (multi-mode) and reset input • Input by short-circuiting or opening contacts. • Open collector input	2-input (multi-mode) and reset input • Input by short-circuiting or opening contacts. • Open collector input
Reset (Reset input specifications conform to those of counting input)	• Front reset button and external reset input terminal • External reset dip terminal	• Manual reset with and external terminal and front reset key • Manual reset types inside one-short output models	• Manual reset with and external terminal and front reset key • Manual reset types inside one-short output models	• Manual reset with and external terminal and front reset key • Manual reset types inside one-short output models	• Manual reset with and external terminal and front reset key • Manual reset types inside one-short output models
Preset	—	• Counter number setting with key switches	• Operation mode setting with dip switches • Counter number setting with key switches	• Operation mode setting with dip switches • Counter number setting with key switches	• Output mode setting with dip switches • Counter number setting with key switches
Control output	—		 or 	 or 	 or 
Power supply output	—	—	—	External power supply 12 V DC 100 mA max. (AC type only)	—
Options	Flush mounting type (No need for easy installation type) Mounting frame, rubber gasket	Mounting frame, rubber gasket	11 P plug-in (terminal block, socket) 8 P plug-in (terminal block, socket)	11 P plug-in (terminal block, socket)	11 P plug-in (terminal block, socket)
Available standards	UL, c-UL, CE	UL, c-UL, CE	UL, c-UL, CE	UL, c-UL, CE	UL, c-UL, CE
Page	P. 98	P. 106	P. 115	P. 123	P. 132

TYPICAL COUNTER APPLICATIONS

The highly accurate, reliable counters can be controlled from the front panel and are suitable for a wide range of applications.

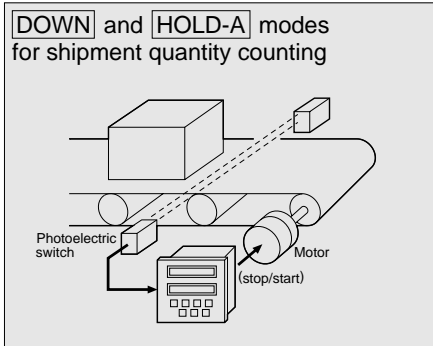

Shipment quantities are counted to control the conveyor line flow.

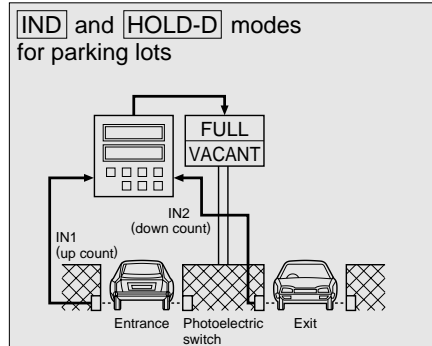

Incoming and outgoing cars are counted to switch the FULL and VACANT signs.

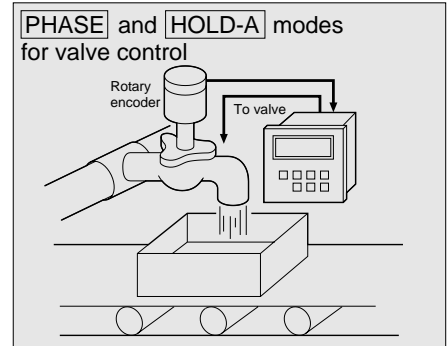

Rotary encoder signals are counted to control a valve aperture.

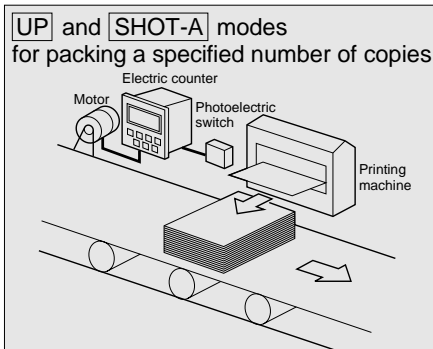

Printed matter is counted to package a specified number of copies.

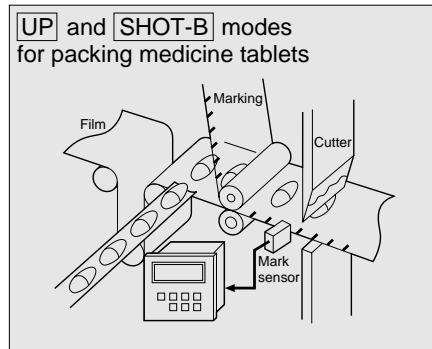

Medicine tablets are packed in specified quantities.

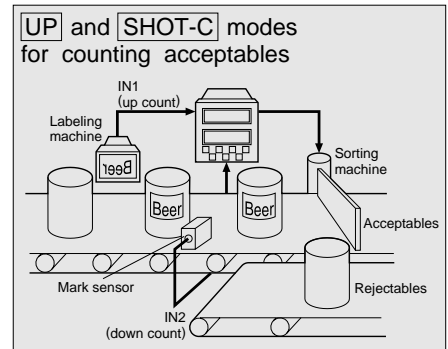

Labeled cans alone are counted up. Rejected cans are not counted.

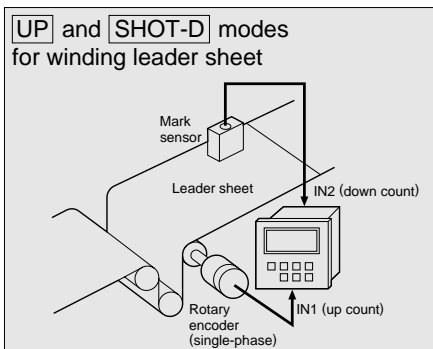

Extra leader sheet that is now wound is counted by a rotary encoder and a color detecting sensor.

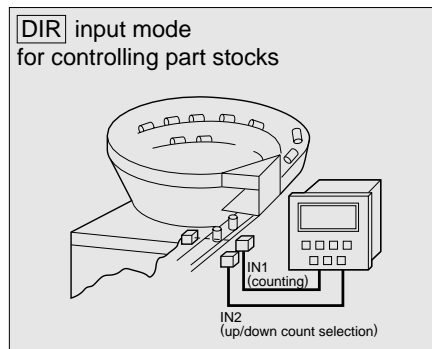

Incoming and outgoing parts are counted to keep parts feeders well-stocked.

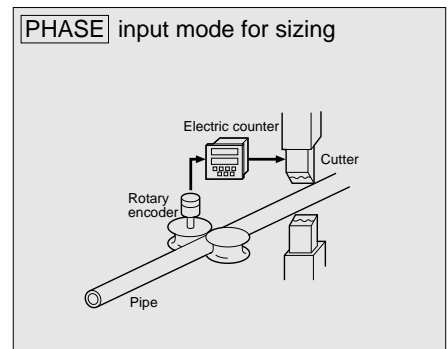

Teamed up with a rotary encoder, the counter is used to control the cutting length of pipes.

COUNTER-RELATED TERMINOLOGY

TYPES OF COUNTERS

1. Electro Preset Counter

The counter is equipped with semiconductor counting circuitry. When the counter counts up to a preset number, its output circuit sends a signal.

2. Electro Magnetic Counter

A magnet is magnetized and demagnetized to drive the dial and count up numbers.

RATING

1. Rated Operating Voltage

The voltage is applied to start the counter.

COUNTINGS

1. Pulse

This is a voltage or current signal sent at intermittent time intervals.

2. Count

Pulses are used to count up and down.

3. Miss-count

This happens if the number of pulses does not correspond to the number of counts.

4. Hertz

This unit of counting speed is used to give the number of counts per one second.

5. Make Ratio

This is the ratio of ON time (T_a) to OFF time (T_b).

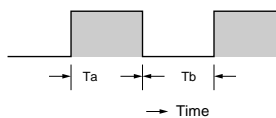

6. Maximum Counting Speed

Suppose that the counter is operated with an input pulse of a make ratio of 1. The highest counting speed is the peak of a range in which the output circuit can send signals without mis-counting. The speed is expressed in units of Hz (cps: counts per a second).

7. Over Count

Counting continues beyond a preset number.

8. Recount

When counting is up, the counter display resets to zero and counting restarts.

9. Down Count

Numbers are counted down one by one from a preset number.

10. Up Count

Numbers are counted up one by one from zero.

11. Up/Down Count

Numbers are counted up or down depending on input conditions.

12. Rejection (gate) Input

This signal is used to keep the counter from counting.

OUTPUTS

1. Count Up

When a preset number is reached, the output circuit sends a signal.

2. Retained Output

The output is held until a reset signal is sent.

3. One Shot Output

This output has a specified width of time.

RESETTINGS

1. Reset

The counting process, display and output sections are all brought back to the initial status.

2. Power off Reset

The operating voltage is turned off to reset the counter.

3. Manual Reset

The counter is manually reset.

4. Remote Reset

A signal is sent from a remote point to the reset terminal so as to reset the counter.

5. Automatic Reset

When counting is up, internal circuitry is activated to automatically reset the counter.

6. Reset Signal Width

This is the time during which the power is off so as to reset the counter or during which an external (manual) reset signal is sent.

7. Reset time

This is the time from the moment a reset signal is sent to the instant the counter is ready to start counting again.

OTHERS

1. Function of Memorizing Condition

Counting data up until the operating voltage is turned off can be stored in memory. When the power is reactivated, the data can be reproduced.

2. Anti-surge

The strength against power voltage surge is determined by applying a single-pole full-wave voltage (several hundred to several thousand volt wave for $\pm(1.2 \times 50) \mu s$) across the control power terminals.

Surge waveform

[Single-pole full-wave voltage for $\pm(1.2 \times 50) \mu s$]

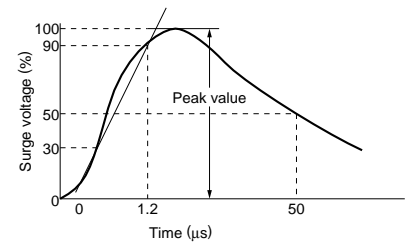

3. Noise Immunity

This is the strength against external noise. Relay noise tests, noise simulator tests, etc. are conducted.

PRECAUTIONS IN USING THE COUNTER

Cautions for circuits

1. Protective circuit for counter contact

In the circuit that switches an inductive load, a contact failure may occur at a contact point due to surge or inrush current resulting from that switching. Therefore, it is recommended that the following protective circuit be used to protect the contact point.

Circuit	CR circuit (r: resistor c: capacitor)		Diode circuit	Varistor circuit
Application	AC DC	(see note.) Available	Available Available	Not available Available
Features/Others	<p>If the load is a relay or solenoid, the release time lengthens. Effective when connected to both contacts if the power supply voltage is 24 or 48 V and the voltage across the load is 100 to 200 V.</p> <p>If the load is a timer, leakage current flows through the CR circuit causing faulty operation. Note: If used with AC voltage, be sure the impedance of the load is sufficiently smaller than that of the CR circuit.</p>		<p>The diode connected in parallel causes the energy stored in the coil to flow to the coil in the form of current and dissipates it as joule heat at the resistance component of the inductive load. This circuit further delays the release time compared to the CR circuit. (2 to 5 times the release time listed in the catalog)</p>	<p>Using the rated voltage characteristics of the varistor, this circuit prevents excessively high voltages from being applied across the contacts. This circuit also slightly delays the release time.</p>
Device Selection	<p>As a guide in selecting r and c, c: 0.5 to 1 μF per 1 A contact current r: 0.5 to 1 Ω per 1 V contact voltage Values vary depending on the properties of the load and variations in counter characteristics. Capacitor c acts to suppress the discharge the moment the contacts open. Resistor r acts to limit the current when the power is turned on the next time. Test to confirm. Use a capacitor with a breakdown voltage of 200 to 300 V. Use AC type capacitors (non-polarized) for AC circuits.</p>		<p>Use a diode with a reverse breakdown voltage at least 10 times the circuit voltage and a forward current at least as large as the load current. In electronic circuits where the circuit voltages reverse breakdown voltage of about 2 to 3 times the power supply voltage.</p>	—

2. Type of Load and Inrush Current

The type of load and its inrush current characteristics, together with the switching frequency, are important factors which cause contact welding. Particularly for loads with inrush currents, measure the steady state current and inrush current and use a relay or magnet switch which provides an ample margin of safety. The table below shows the relationship between typical loads and their inrush currents.

Type of load	Inrush current
Resistive load	Steady state current
Solenoid load	10 to 20 times the steady state current
Motor load	5 to 10 times the steady state current
Incandescent lamp load	10 to 15 times the steady state current
Mercury lamp load	1 to 3 times the steady state current
Sodium vapor lamp load	1 to 3 times the steady state current
Capacitive load	20 to 40 times the steady state current
Transformer load	5 to 15 times the steady state current

When you want large load and long life of the counter, do not control the load direct with a counter. When the counter is designed to use a relay or a magnet switch, you can acquire the longer life of the counter.

3. Connection of input (Except for LC4H-S/AC type)

The LC4H series use power supply without a transformer (power and input terminals are not insulated). In connecting

various kinds of input signals, therefore, use a power transformer in which the primary side is separated from the ungrounded secondary side as shown in Fig. A, for the power supply for a sensor and other input devices so that short-circuiting can be prevented.

(Fig. A) Good

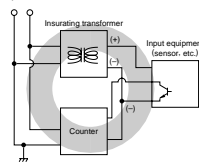

(Fig. B) No good

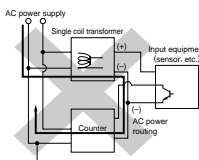
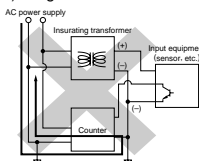

Do not use a single coil transformer (e.g., Sly-Duck). Otherwise, the internal circuit of the counter will be short-circuited as shown in Fig. B resulting in breakdown.

4. Long Continuous Current Flow

Avoid keeping the counter on for a long period of time (over one month). Otherwise heat is generated and accumulated inside the counter, which may deteriorate its electronic parts. If the counter must be kept on for a long period of time, a relay is added. See the circuit diagram below.

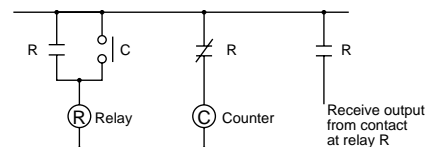

PRECAUTIONS IN USING THE COUNTER

5. Leakage current

1) For connecting operating voltage to the counter, a circuit should be used, which will prevent the flow of leakage current. For example, a circuit for contact protection as shown in Fig. A. will permit leakage current flow through R and C, causing erroneous operation of the counter. Instead, the circuit shown in Fig. B should be used.

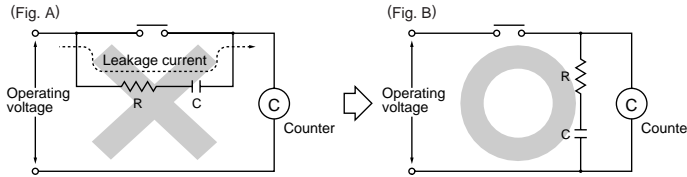

2) If the counter is directly switched with a non-contact element, leakage current may flow into the counter and cause it to malfunction.

Cautions for use (common for all models)

1. Terminal connections

Correctly connect the pins while seeing the terminal layout/wiring diagram. In particular, the DC type, which has polarities, does not operate with the polarities connected reverse. Any incorrect connection can cause abnormal heating or ignition.

2. Connection to operating voltage

1) Apply the entire supply voltage through a switch, relay or other contact.
2) The operating voltage for the DC type must be at the specified ripple percentage or less. The average voltage must fall within the allowable operating voltage range.

Rectification type	Ripple percentage
Single-phase, full-wave	Approx. 48%
Three-phase, full-wave	Approx. 4%
Three-phase, half-wave	Approx. 17%

3) Make sure that no induced voltage and residual voltage are applied between the power terminals on the counter after the power switch is turned OFF. (If the power line is wired in parallel with the high-voltage and motor lines, induced voltage may be produced between the power pins.)

3. Control output

1) Keep the load capacity below the counter's rated control capacity. If used above the rating, the counter's service life may shorten. With the transistor output type counters, transistors may be damaged.

4. Installing the counter

1) To install the counter, use the dedicated pin bracket or socket (cap). Avoid connecting the pins on the counter by directly soldering them.
2) In order to maintain the characteristics, do not remove the counter cover (case).

5. Superimposed surge of power supply

For the superimposed surge of power supply, the standard waveform ($\pm 1.2 \times 50\mu\text{s}$ or $\pm 1 \times 40\mu\text{s}$) is taken as the standard value for surge-proof voltage. (The positive and negative voltages are applied each three or five times between the power pins.)

For the standard values for the LC4H type counters, see the respective items in "Cautions for use."

• Single-pole, full-wave voltage for surge waveform [$\pm(1.2 \times 50) \mu\text{s}$]

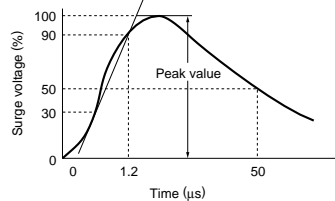

If external surge occurs exceeding the specified value, the internal circuit may break down. In this case, use a surge absorption element. The typical surge absorption elements include a varistor, a capacitor, and a diode. If a surge absorption element is used, use an oscilloscope to see whether or not the foreign surge exceeding the specified value appears.

6. Signal input

The counter's signal input comes in two ways. One is by opening and closing the input terminal. The other is by applying a specified H-level or L-level voltage to the input terminal.

For an input sensor's residual voltage, input impedance, input voltage level and other signal input conditions, see the ratings for each type of product.

7. Operating environment

1) For the ambient operating temperature and humidity, see the ratings for each type of product.
2) Avoid using the counter in a location where inflammable or corrosive gas is generated, the counter is exposed to much dust and other foreign matter; water or oil is splashed on the counter; or vibrations or shocks are given to the counter.

3) The counter cover (case), the knobs, and the dials are made of polycarbonated resin. Therefore, prevent the counter from being exposed to organic solvents such as methyl alcohol, benzene, and thinner, strong acid substances such as caustic soda, and ammonia and avoid using the counter in atmosphere containing any of those substances.

4) If the counter is used where noises are emitted frequently, separate the input signal elements (such as a sensor), the wiring for the input signal line, and the counter as far as possible from the noise source and the high power line containing noises.

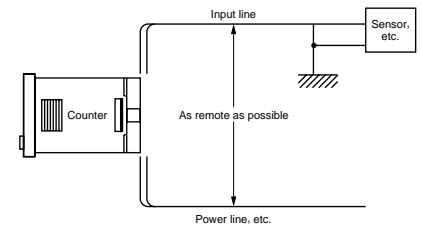

8. Checking the actual load

In order to increase the reliability in the actual use, check the quality of the counter in the actual usage.

9. Others

1) If the counter is used exceeding the ratings (operating voltage and control capacity), the contact life, or any other specified limit, abnormal heat, smoke, or ignition may occur.
2) The LC2H series counter, incorporates a lithium battery. Never disassemble the lithium battery or throw it into fire because this may affect humans and facilities. The lithium battery must be disposed of as an incom-bustible like other used batteries.
3) If any malfunction of the counter is likely to affect human life and properties, give allowance to the rated values and performance values. In addition, take appropriate safety measures such as a duplex circuit from the viewpoint of product liabilities.

DIN SIZE COUNTERS COMMON OPTIONS

Terminal sockets (Unit: mm inch, Tolerance: $\pm 1 \pm .039$)

Type	Appearance	Dimensions	Terminal wiring (Top view)	Mounting hole dimensions
LC4H LC4H-L (8-pin type)	<ul style="list-style-type: none"> • DIN rail socket (8-pin) 		<p>Note: Terminal No. on the main body are identical to those on the terminal socket.</p>	
LC4H LC4H-L LC4H-S LC4H-W (11-pin type)	<ul style="list-style-type: none"> • DIN rail socket (11-pin) 		<p>Note: Terminal No. on the main body are identical to those on the terminal socket.</p>	

Note: The terminal numbers on the counter are identical to those on the terminal socket.

Sockets (Unit: mm inch, Tolerance: $\pm 1 \pm .039$)

Type	Appearance	Dimensions	Terminal wiring (Top view)	Mounting hole dimensions
LC4H LC4H-L (8-pin type)	<ul style="list-style-type: none"> • Rear terminal socket 			—
	<ul style="list-style-type: none"> • 8P cap 			—
LC4H LC4H-L LC4H-S LC4H-W (11-pin type)	<ul style="list-style-type: none"> • Rear terminal socket 			—
	<ul style="list-style-type: none"> • 11P cap 			—

Note: The terminal numbers on the counter are identical to those on the socket.

DIN SIZE COUNTERS COMMON OPTIONS

Mounting parts

• Rubber gasket

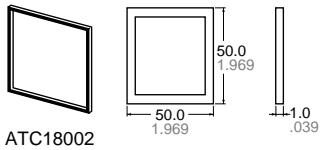

ATC18002

Applicable for LC4H series

The rubber gasket is enclosed in the LC4H series.

• Mounting frame

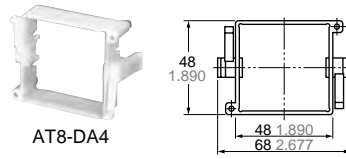

AT8-DA4

Applicable for LC4H series

• Mounting rails (Applicable for DIN and IEC standards)



AT8-DLA1
Length: 1 m
aluminum

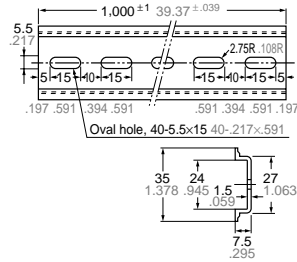

• Fastening plate



ATA4806

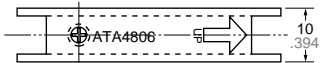
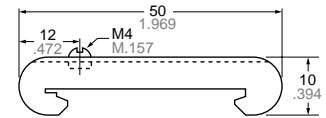

For holding DIN rails

• Protective cover for DIN 48 size

Flexible type

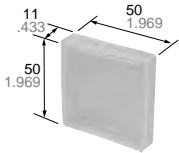

AQM4803

Accessories

• Panel cover (Black)

LC4H Panel cover (4 digits)



AEL58011

LC4H Panel cover (6 digits)

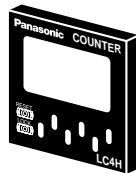

AEL58012

LC4H-S Panel cover (4 digits)



AEL58013

LC4H-S Panel cover (6 digits)

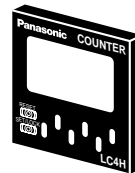

AEL58014

LC4H-W Panel cover

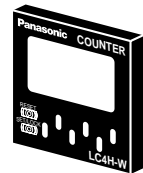

AEL68011

The black panel cover is also available so that you can change the appearance of the panel by changing the panel cover. The color of the standard panel cover is ash gray.

INSTALLING DIN SIZE COUNTER

Installation methods

1. Surface mount

1) For the counters of LC4H series, use the pin type counter.

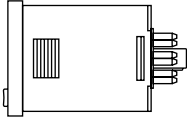

- 2) Put the terminal socket on the board directly or put it on the DIN rail (Fig. 1).
- 3) Insert the counter into the terminal socket and fix it with clip (Fig. 2)
- 4) On DIN rail mounting, mount the counter on the DIN rail tightly to get the proper dimension (Fig. 3).

(Fig. 1)

(Fig. 2)

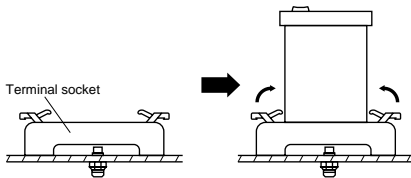

(Fig. 3)

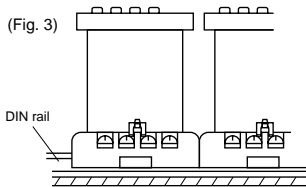

- 5) 8-pin type should be connected with terminal socket AT8-DF8K. 11-pin type should be connected with terminal socket AT8-DF11K.
- 6) DIN rail (AT8-DLA1) is also available (1 m).

2. Flush mount

1) For the counters of LC4H series, it is recommended to use the built-in screw terminal type for flush mount. (Mounting frame and rubber gasket are provided when counter is shipped.)

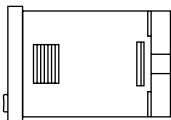

2) How to mount the counter
From the panel front, pass the counter through the square hole. Fit the mounting frame from the rear, and then push it in so that the clearance between the mounting frame and the panel surface is minimized. In addition, lock the mounting frame with a screw.

• LC4H series

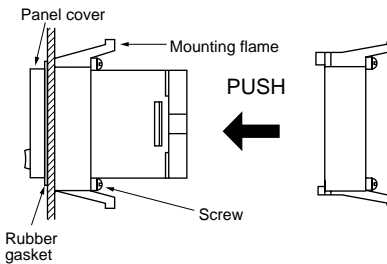

3) Caution in mounting the counter

• LC4H series

- Ⓐ If the LC4H series are used as the waterproof types (IEC IP66), tighten the reinforcing screws on the mounting frames so that the counters, the rubber gaskets, and the panel surfaces are tightly contacted with each other. (Tighten the two screws with uniform force and make sure that there is no rattling. If the screws are tightened too excessively, the mounting frame may come off.)
 - Ⓑ If the counter is installed with the panel cover and the rubber gasket removed, the waterproofing characteristic is lost.
- 4) Removal
Loosen the screws on the mounting frame, spread the edge of frame and remove it.

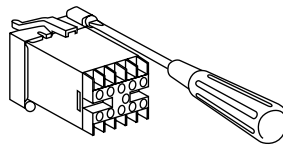

Pull the mounting frame backward while spreading out its hooks with your thumbs and index fingers.

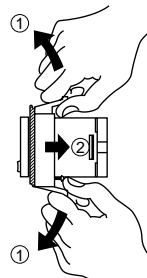

5) Correctly connect the terminals while seeing the terminal layout and wiring diagram.

6) If the pin type is used, the rear pin-bracket (AT8-RR) or the 8P cap (AD8-RC) is necessary to connect the pins. For the 11-pin type, use the 11P cap (AT8-DP11) and avoid directly soldering the round pins on the counter.

7) Panel cutout dimensions

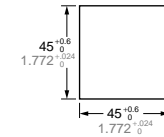

The standard panel cutout dimensions are shown in the left figure. (Panel thickness: 1 to 5 mm .039 to .197 inch)

8) Although the counters can be mounted adjacent to each other in this case, it is recommended to arrange the mounting holes as shown in the figure to facilitate attaching and detaching the mounting frame.

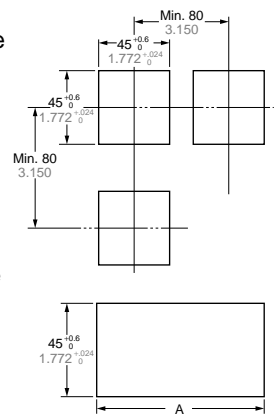

9) Adjacent mounting

Although the counters can be mounted adjacent to each other, remember that the panel surface of LC4H series counter will lose its water-resistant effect. (Panel thickness: 1 to 5 mm .039 to .197 inch)





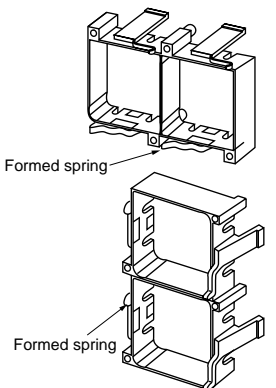





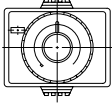



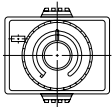













$A = (48 \times n - 2.5)^{+0.6}_0$
When lining up the counters horizontally, set the frames in such a position so the formed spring areas are at the top and bottom.

When lining up the counters vertically, set the frames in such a position as the formed spring areas are at the right and left.

























DISCONTINUED MODELS AND RECOMMENDED SUBSTITUTES















Timers













Discontinued models	Recommended substitutes	Attachment	Discontinued models	Recommended substitutes	Attachment
MHP-NS (Exposed type Square plug-in/ horizontal type) 	MHP-N (Exposed type Round plug-in/ vertical type) 	Terminal base AT8-RFD should be used.	CHP-NF (Exposed type Round plug-in/ vertical type) 	PM4H-F 	Attachment frame AT7821 should be used. * External dimensions, however, differ. In addition, the reset method changes from voltage input to non-voltage input.
MHP-NS-	MHP-N-		CHP-NF	PM4HF-	
MHP-M (Exposed type Round plug-in/ horizontal type) 	MHP-NM (Exposed type Round plug-in/ vertical type) 	Terminal base AT8-RFD should be used.	CHP-SD 	PM4H-SD 	With exposed attachment, terminal base ATC180041 should be used. * External dimensions and contact capacity, however, differ. In addition, with the PM4H-SD: 1) (1) to (8) have no internal connection, and 2) the input (star) changes to 1a.
MHP-M-	MHP-NM-		CHP-SD-	PM4HSD-	
MHP-YC (Embedded type With attachment frame) 	MHP-N (Exposed type Without attachment frame) 	Attachment frame AT7821 should be used.	PM48A 	PM4H-A 	With exposed attachment, terminal base ATC180041 should be used.
MHP-YC-	MHP-N-		PM48A-	PM4HA-	
MHP-YM (Embedded type With attachment frame) 	MHP-NM (Exposed type Without attachment frame) 	Attachment frame AT7831 should be used.	PM48 	PM4H-S 	With exposed attachment, terminal base ATC180031 should be used.
MHP-YM-	MHP-NM-		PM48	PM4HS-	
CHP-N (Exposed type with attachment frame type) 	PM4H-S PMH 	The external dimension and contact capacity are different.	PM48M 	PM4H-M 	With exposed attachment, terminal base ATC180031 for F8 type and F8R type ATC180041 for F11R type.
CHP-N-	PM4HS- PMH-		PM48M-	PM4HM-	
CHP-N (Exposed type without attachment frame type) 	PM4H-S PMH 	The external dimension and contact capacity are different.	PM48F 	PM4H-F 	With exposed attachment, terminal base ATC180031 for F8 type and F8R type ATC180041 for F11R type.
CHP-N-	PM4HS- PMH-		PM48F-	PM4HF-	
CHP-NF (Exposed type without attachment frame type) 	PM4H-F 	* External dimensions, however, differ. In addition, the reset method changes from voltage input to non-voltage input.	PM48SD 	PM4H-SD 	With exposed attachment, terminal base ATC180031 should be used.
CHP-NF-	PM4HF-		PM48SD	PM4HSD	

Timers

Discontinued models	Recommended substitutes	Attachment	Discontinued models	Recommended substitutes	Attachment
PM48W 	PM4H-W 	With exposed attachment, terminal base ATC180031 should be used.	LT48 (8-pin) 	LT4H (8-pin) 	
PM48W	PM4H-W-		LT48	LT4H LT4H-L	
PMH-M 	PM4H-M/PM4S 	The external dimension and contact capacity are different.	LT48W (8-pin) 	LT4H-W (8-pin) 	
PMH-M-	PM4HM-/PM4S-		LT48W	LT4HW	
CDX Time relay 	S1DXM-A Timer/ S1DX Timer 		DIN rail socket (8-pin) 	DIN rail socket (8-pin) 	
CDX	S1DXM-/S1DX-		ATC18003	ATC180031	
PDX Timer 	S1DXM-A Timer/ S1DX Timer 		DIN rail socket (11-pin) 	DIN rail socket (11-pin) 	
PDX	S1DXM-/S1DX-		ATC18004	ATC180041	
VHP digital high-power timer 	QM4H digital timer 	The size is different. Compact size ↓ DIN48			
VHP	QM4H				
QM48S (8-pin) 	QM4H (8-pin) 				
QM48S	QM4H				
QM72S (Screw terminal) 	QM4H (8-pin) 	The size is different. □72 ↓ □48			
QM72S	QM4H				

In some cases, the specifications of the recommended substitutes are not exactly the same as those of the discontinued model. Please confirm the specifications before using the recommended substitutes.

Counters		
Discontinued models	Recommended substitutes	Attachment
MC6 	LC4H 	The size and attachment method are different. The input method is different. (Voltage input → non-voltage input)
LC48 (Relay type: 8-pin Tr type: 11-pin) 	LC4H (Relay type: 8-pin Tr type: 11-pin) 	
LC48W (11-pin) 	LC4H-W (11-pin) 	
EM48S (8-pin) 	LC4H (8-pin) 	
EM72S (Screw terminal) 	LC4H (Screw terminal) 	The size is different. <input type="checkbox"/> 72  <input type="checkbox"/> 48
LC24 Panel-mounting type  <ul style="list-style-type: none"> • One-touch installation type LC24 	LC2H Panel-mounting type  <ul style="list-style-type: none"> • One-touch installation type • Installation frame type LC2H 	The both one-touch installation type and installation frame type are available.
LC24 PC board mounting type 	LC2H PC board mounting type 	

Hour meters		
Discontinued models	Recommended substitutes	Attachment
TH11* TH12* 	TH141S TH142S 	Body Round type (attachment hole ϕ 45)  Square type (attachment hole \square 45)
TH21* TH22* 	TH241S TH242S 	Body Square type (attachment hole \square 47)  Square type (attachment hole \square 45)
TH30 	LT4H (~999.9 h) 	The size and attachment method are different. The input method is different. (Voltage input → non-voltage input)
	LT4H-W (~9999 h) 	
LH24 Panel-mounting type  <ul style="list-style-type: none"> • One-touch installation type LH24 	LH2H Panel-mounting type  <ul style="list-style-type: none"> • One-touch installation type • Installation frame type LH2H 	The both one-touch installation type and installation frame type are available.
LH24 PC board mounting type 	LH2H PC board mounting type 	

In some cases, the specifications of the recommended substitutes are not exactly the same as those of the discontinued model. Please confirm the specifications before using the recommended substitutes.

FOREIGN SPECIFICATIONS OVERVIEW

1. International Standards

IEC standard

International Electrotechnical Commission

By promoting international cooperation toward all problems and related issues regarding standardization in the electrical and electronic technology fields, the IEC, a non-governmental organization, was started in October, 1908, for the purpose of realizing mutual understanding on an international level. To this end, the IEC standard was enacted for the purpose of promoting international standardization.

2. North America

UL (Underwriters Laboratories Inc.)

This is a non-profit testing organization formed in 1894 by a coalition of U.S. fire insurance firms, which tests and approves industrial products (finished products). When electrical products are marketed in the U.S., UL approval is mandated in many states, by state law and city ordinances. In order to obtain UL approval, the principal parts contained in industrial products must also be UL-approved parts.

UL approval is divided into two general types. One is called "listing" (Fig. 1), and applies to industrial products (finished products). Under this type of approval, products must be approved unconditionally. The other type is called "recognition" (Fig. 2), and is a conditional approval which applies to parts and materials.

LISTING MARK



Fig. 1

RECOGNITION MARK



Fig. 2

Certification



Fig. 3

Component Acceptance



Fig. 4



Fig. 5



Fig. 6

CSA (Canadian Standards Association)

This was established in 1919 as a non-profit, non-governmental organization aimed at promoting standards. It sets standards for industrial products, parts, and materials, and has the authority to judge electrical products to determine whether they conform to those standards. The CSA is the ultimate authority in the eyes of both the government and the people in terms of credibility and respect. Almost all states and provinces in Canada require CSA approval by law, in order to sell electrical products. As a result, electrical products exported from Japan to Canada are not approved under Canadian laws unless they have received CSA approval and display the CSA mark. Approval is called "certification", and products and parts which have been approved are called "certified equipment", and display the mark shown in Fig. 3. The mark shown in Fig. 4 is called the "Component Acceptance" mark, and indicates conditional approval which is applicable to parts. The C-UL mark shown in Fig. 5 (finished products) and Fig. 6 (parts) indicates that the product has been tested and approved in UL laboratories, based on UL and CSA standards, through mutual approval activities.

3. Europe

EN standard

European Standards/Norme Europeenne (France)/Europaishe Norm (Germany)

Abbreviation for European Standards. A unified standard enacted by CEN/CENELEC (European Standards Committee/European Electrical Standards Committee). EU and EFTA member nations employ the content of the EN standards into their own national standards and are obligated to abolish those national standards that do not agree with the EN standards.

(1) Germany



VDE (Verband Deutscher Elektrotechniker)

The VDE laboratory was established mainly by the German Electric Technology Alliance, which was formed in 1893. It carries out safety experiments and passes approval for electrical devices and parts. Although VDE certification is not enforced under German law, punishment is severe should electrical shock or fire occur; therefore, it is, in fact, like an enforcement.



TÜV (Technischer Überwachungs-Verein)

TÜV is a civilian, non-profit, independent organization that has its roots in the German Boiler Surveillance Association, which was started in 1875 for the purpose of preventing boiler accidents. A major characteristic of TÜV is that it exists as a combination of 14 independent organizations (TÜV Rheinland, TÜV Bayern, etc.) throughout Germany. TÜV carries out inspection on a wide variety of industrial devices and equipment, and has been entrusted to handle electrical products, as well, by the government. TÜV inspection and certification is based mainly on the VDE standard. TÜV certification can be obtained from any of the 14 TÜVs throughout Germany and has the same effectiveness as obtaining VDE certification.

4. Shipping Standards

(1) Lloyd's Register of Shipping



Standards from the Lloyd's Register shipping association based in England. These standards are safety standards for environmental testing of the temperature and vibration tolerances of electrical components used for UMS (unmanned machine rooms in marine vessels) applications. These standards have become international standards for control equipment in all marine vessel applications. No particular action is taken to display the conformation to these standards on the products.

5. Pilot Duty

One of the specifications in the "UL508 Industrial Control Equipment" regulations at UL (Underwriters Laboratories Inc.), has to do with the grade of contact control capacity by NEMA (National Electrical Manufacturers Association) standards. By obtaining both UL and CSA approval for this grade, the product becomes authorized publicly.

Pilot Duty A300

AC applied voltage [V]	Electrification current [A]	Input power [A]	Breaker power [A]	[VA]	
				During input	During breaker
120	10	60	6	7,200	720
240		30	3	7,200	720

Pilot Duty B300

AC applied voltage [V]	Electrification current [A]	Input power [A]	Breaker power [A]	[VA]	
				During input	During breaker
120	5	30	3	3,600	360
240		15	1.5	3,600	360

Pilot Duty C300

AC applied voltage [V]	Electrification current [A]	Input power [A]	Breaker power [A]	[VA]	
				During input	During breaker
120	2.5	15	1.5	1,800	180
240		7.5	0.7	1,800	180

FOREIGN SPECIFICATIONS

TIMER

Products Name	Recognized by UL Standards		Certified by CSA Standards		Lloyd's Register Standards		Remarks	
	File No.	Recognized rating	File No.	Certified rating	File No.	Certified rating		
PM4S	E43149	5A250VAC PILOT DUTY C300	E43149 (C-UL)	5A250VAC PILOT DUTY C300	—	—		
PM4H-A PM4H-S PM4H-M PM4H-SD PM4H-W	E122222	5A250VAC PILOT DUTY C300	LR39291	5A250VAC PILOT DUTY C300	98/10004	5A 250V AC (resistive)		
PM4H-F	E122222	3A250VAC PILOT DUTY C300	LR39291	3A250VAC PILOT DUTY C300	98/10004	3A 250V AC (resistive)		
LT4H LT4H-L LT4H-W	E122222	5A250VAC PILOT DUTY C300 100mA30VDC	E122222 (C-UL)	5A250VAC PILOT DUTY C300 100mA30VDC	—	—		
QM4H	E43149	5A250VAC PILOT DUTY C300	E43149 (C-UL)	5A250VAC PILOT DUTY C300	—	—		
PMH	E59504	7A1/6HP125VAC 7A1/6HP250VAC 3A30VDC PILOT DUTY C300	LR39291	7A1/6HP125VAC 7A1/6HP250VAC 3A30VDC PILOT DUTY C300	88/10123	125V3.5A (COS $\phi \approx 0.4$) 250V2A (COS $\phi \approx 0.4$) 250V7A (COS $\phi \approx 1.0$)	"The standard models conform to the UL/CSA standard. (To place an order, you do not need to specify the tailing character [9] of each item number.)" The standard models conform to the LLOYD standard.	
MHP MHP-M	E59504	5A250VAC	LR39291	5A250VAC	88/10123	250V5A (COS $\phi \approx 1.0$)	"The standard models conform to the UL/CSA standard. (To place an order, you do not need to specify the tailing character [9] of each item number.)"	
S1DXM-A/M (Relay output)	2C	E122222	7A125VAC 6A250VAC 1/6HP125, 250VAC PILOT DUTY C300	LR39291	7A125VAC 6A250VAC 1/6HP125, 250VAC PILOT DUTY C300	98/10004	7A 250V AC (resistive)	
	4C	E122222	5A250VAC 1/10HP125, 250VAC PILOT DUTY C300	LR39291	5A250VAC 1/10HP125, 250VAC PILOT DUTY C300	98/10004	5A 250V AC (resistive)	
S1DX (Relay output)	2C	E122222	7A125VAC 6A250VAC 1/6HP125, 250VAC PILOT DUTY C300	LR39291	7A125VAC 6A250VAC 1/6HP125, 250VAC PILOT DUTY C300	98/10004	7A 250V AC (resistive)	
	4C	E122222	5A250VAC 1/10HP125, 250VAC PILOT DUTY C300	LR39291	5A250VAC 1/10HP125, 250VAC PILOT DUTY C300	98/10004	5A 250V AC (resistive)	
PM5S-A PM5S-S PM5S-M	E59504 (C-UL)	5A250VAC PILOT DUTY C300	E59504 (C-UL)	5A250VAC PILOT DUTY C300	—	—		

Accessories

Products Name	Recognized by UL Standards		Certified by CSA Standards		Lloyd's Register Standards		Remarks
	File No.	Recognized rating	File No.	Certified rating	File No.	Certified rating	
Common mounting tracks for timers	E59504	10A250VAC AT8-RFD (AT78039) 7A250VAC AT8-DF8L (ATA48211) 8P cap was an approved as an option. AD8-RC (AD8013)	LR39291	10A250VAC AT8-RFD (AT78039) 7A250VAC AT8-DF8L (ATA48211) 8P cap was an approved as an option. AD8-RC (AD8013)	—	—	
	E148103	AT8-DF8K (ATC180031) AT8-DF11K (ATC180041) AT8-R8K (AT78041) AT8-R11K (AT78051)	E148103 (C-UL)	AT8-DF8K (ATC180031) AT8-DF11K (ATC180041) AT8-R8K (AT78041) AT8-R11K (AT78051)	—	—	

FOREIGN SPECIFICATIONS

Counters

Product name	UL recognized		CSA certified		Remarks
	File No.	Approved ratings	File No.	Approved ratings	
LC4H LC4H-L LC4H-S	E122222	5A250V AC PILOT DUTY C300 ----- 100mA 30V DC	E122222 (C-UL)	5A250V AC PILOT DUTY C300 ----- 100mA 30V DC	
LC4H-W	E122222	3A250V AC PILOT DUTY C300 ----- 100mA 30V DC	E122222 (C-UL)	3A250V AC PILOT DUTY C300 ----- 100mA 30V DC	
LC2H	E122222	24-240 V AC/DC 4.5-30 V DC 3 V DC	E122222 (C-UL)	24-240 V AC/DC 4.5-30 V DC 3 V DC	
LC2H preset	E122222	24-240 V AC/DC 4.5-30 V DC 3 V DC	E122222 (C-UL)	24-240 V AC/DC 4.5-30 V DC 3 V DC	

Hour Meters

Product name	UL recognized		CSA certified		Remarks
	File No.	Approved ratings	File No.	Approved ratings	
TH13 · TH23 series	E42876	115-120, 220, 240V AC	LR39291	115-120, 220, 240V AC	• For UL-recognized and CSA-certified products, specify "U" at the end of the part No.
TH14 · TH24 series	E42876	12, 24, 48, 100, 110, 115-120, 200, 220, 240V AC	LR39291	12, 24, 48, 100, 110, 115-120, 200, 220, 240V AC	• Only black panel-mounting type UL-recognized and CSA-certified. • For UL-recognized and CSA-certified products, specify "U" at the end of the product code. • Panel-mounting silver type not UL-recognized nor CSA-certified.
TH63 · 64 series	E42876	12, 24, 48, 100, 110, 115-120, 200, 220, 240V AC	LR39291	12, 24, 48, 100, 110, 115-120, 200, 220, 240V AC	• Standard products are UL-recognized and CSA-certified.
LH2H	E122222	24-240 V AC/DC 4.5-30 V DC 3 V DC	E122222 (C-UL)	24-240 V AC/DC 4.5-30 V DC 3 V DC	• Standard products are UL-recognized and CSA-certified.
LH2H preset	E122222	24-240 V AC/DC 4.5-30 V DC 3 V DC	E122222 (C-UL)	24-240 V AC/DC 4.5-30 V DC 3 V DC	• Standard products are UL-recognized and CSA-certified.
TH8 series	E42876	12 V DC 24 V DC	E42876 (C-UL)	12 V DC 24 V DC	• Standard products are UL-recognized and CSA-certified.

Accessories

Product name	UL-recognized		CSA certified		Remarks
	File No.	Rating	File No.	Rating	
Common counter fixtures	E59504	10A250V AC AT8-RFD (AT78039) 7A250V AC AT8-DF8L (ATA48211) 8P cap CSA-certified as option. AD8-RC (AD8013)	LR26550	10A250V AC AT8-RFD (AT78039) 7A250V AC AT8-DF8L (ATA48211) 8P cap UL-listed as option. AD8-RC(AD8013)	
	E148103	AT8-DF8K (ATC180031) AT8-DF11K (ATC180041) AT8-R8K (AT78041) AT8- R11K (AT78051)	E148103 (C-UL)	AT8-DF8K (ATC180031) AT8-DF11K (ATC180041) AT8-R8K (AT78041) AT8- R11K (AT78051)	

CE MARKINGS OVERVIEW

Counter, Hour Meter conforming to EN/IEC standards

The Timer, Counter, Hour Meter shown below conform to both EN and IEC standards, and may display the CE markings.

Product classification	Product name	EMC directives	Low-voltage directives
Timers	LT4H	EN 61000-6-4/EN 61000-6-2	EN 61812-1
	LT4H-L	EN 61000-6-4/EN 61000-6-2	EN 61812-1
	LT4H-W	EN 61000-6-4/EN 61000-6-2	EN 61812-1
	PM4H	EN 61000-6-4/EN 61000-6-2	EN 61812-1
	S1DX	EN 61000-6-4/EN 61000-6-2	EN 61812-1
	S1DXM-A/M	EN 61000-6-4/EN 61000-6-2	EN 61812-1
	PM4S	EN 61000-6-4/EN 61000-6-2	EN 61812-1
	PM5S	EN 61000-6-4/EN 61000-6-2	EN 61812-1
	QM4H	EN 61000-6-4/EN 61000-6-2	EN 61010-1
Time Switch	A-TB72	EN 61000-6-4/EN 61000-6-2	EN 61812-1
	A-TB72Q	EN 61000-6-4/EN 61000-6-2	EN 61812-1
Counters	LC4H	EN 61000-6-4/EN 61000-6-2	EN 61812-1
	LC4H-L	EN 61000-6-4/EN 61000-6-2	EN 61812-1
	LC4H-S	EN 61000-6-4/EN 61000-6-2	EN 61812-1
	LC4H-W	EN 61000-6-4/EN 61000-6-2	EN 61812-1
	LC2H	EN 61000-6-4/EN 61000-6-2	EN 61010-1
	LC2H preset	EN 61000-6-4/EN 61000-6-2	—
Hour Meters	TH13	EN 61000-6-4/EN 61000-6-2	EN 61010-1
	TH23	EN 61000-6-4/EN 61000-6-2	EN 61010-1
	TH14	EN 61000-6-4/EN 61000-6-2	EN 61010-1
	TH24	EN 61000-6-4/EN 61000-6-2	EN 61010-1
	TH40	EN 61000-6-4/EN 61000-6-2	EN 61010-1
	TH50	EN 61000-6-4/EN 61000-6-2	EN 61010-1
	TH63	EN 61000-6-4/EN 61000-6-2	EN 61010-1
	TH64	EN 61000-6-4/EN 61000-6-2	EN 61010-1
	LH2H	EN 61000-6-4/EN 61000-6-2	EN 61010-1
	LH2H preset	EN 61000-6-4/EN 61000-6-2	—
	TH8	EN 61000-6-4/EN 61000-6-2	—

What are EN standards?

An abbreviation of Norme Europeenne (in French), and called European Standards in English. Approval is by vote among the CEN/CENELEC member countries, and is a unified standards limited to EU member countries, but the contents conform to the international ISO/IEC standards.

If the relevant EN standard does not exist, it is necessary to obtain approval based on the relevant IEC standard or, if the relevant IEC standard does not exist, the relevant standard from each country, such as VDE, BS, SEMKO, and so forth.

CE markings and EC directives

The world's largest single market, the European Community (EC) was born on 1 January 1993 (changing its name to EU in November 1993. It is now always expressed as EU, apart from EC directives.) EU member country products have always had their quality and safety guaranteed according to the individual standards of each member country. However, the standards of each country being different prevented the free flow of goods within the EU. For this reason, in order to eliminate non-tariff barriers due to these standards, and to maximize the merits of EU unification, the EC directives were issued concomitant to the birth of the EU.

The EN standards were established as universal EU standards in order to facilitate EU directives. These standards were merged with the international IEC standards and henceforth reflect the standards in all countries. Also, the CE markings show that products conform to EC directives, and guarantee the free flow of products within the EC.

Appropriate EC directives for control equipment products

The main EC directives that are to do with machinery and electrical equipment are the machinery directive, the EMC directive, the low voltage directive, and the telecom directive. Although these directives have already been issued, the date of their enactment is different for each one. The machinery directive was 1 January 1995. The EMC directive was 1 January 1996, and the low voltage directive was enacted from 1 January 1997. The telecom directive was established by the separate CTR (Common Technology References.)