

AMMC-6231

16–32 GHz Low Noise Amplifier

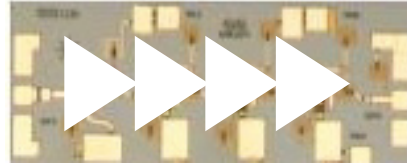

Data Sheet



Chip Size: 1900 x 800 μm (74.8 x 31.5 mils)
Chip Size Tolerance: $\pm 10 \mu\text{m}$ (± 0.4 mils)
Chip Thickness: $100 \pm 10 \mu\text{m}$ (4 ± 0.4 mils)
RF Pad Dimensions: 110 x 90 μm (4.33 x 3.54 mils)
DC Pad Dimensions: 100 x 100 μm (3.94 x 3.94 mils)

Description

Avago Technologies AMMC-6231 is a high gain, low-noise amplifier that operates from 16 GHz to 32 GHz. This LNA provides a wide-band solution for system design since it covers several bands, thus, reduces part inventory. The device has input / output match to 50 Ohm, is unconditionally stable and can be used as either primary or sub-sequential low noise gain stage. By eliminating the complex tuning and assembly processes typically required by hybrid (discrete-FET) amplifiers, the AMMC-6231 is a cost-effective alternative in the 16 - 32 GHz communications receivers. The backside of the chip is both RF and DC ground. This helps simplify the assembly process and reduces assembly related performance variations and costs. It is fabricated in a PHEMT process to provide exceptional noise and gain performance. For improved reliability and moisture protection, the die is passivated at the active areas.

Features

- Wide frequency range: 16 - 32 GHz
- High gain: 22 dB
- Low 50 Ω Noise Figure: 2.6 dB
- 50 Ω Input and Output Match
- Flat Gain Response
- Single 3V Supply Bias

Applications

- Microwave Radio systems
- Satellite VSAT, DBS Up/Down Link
- LMDS & Pt-Pt mmW Long Haul
- Broadband Wireless Access (including 802.16 and 802.20 WiMax)
- WLL and MMDS loops

AMMC-6231 Absolute Maximum Ratings^[1]

Symbol	Parameters/Conditions	Units	Min.	Max.
V_d	Positive Drain Voltage	V		7
V_g	Gate Supply Voltage	V		NA
I_d	Drain Current	mA		100
P_{in}	CW Input Power	dBm		15
T_{ch}	Operating Channel Temp.	$^{\circ}\text{C}$		+150
T_{stg}	Storage Case Temp.	$^{\circ}\text{C}$	-65	+150
T_{max}	Maximum Assembly Temp (60 sec max)	$^{\circ}\text{C}$		+300

Note:

1. Operation in excess of any one of these conditions may result in permanent damage to this device.



Note: These devices are ESD sensitive. The following precautions are strongly recommended. Ensure that an ESD approved carrier is used when dice are transported from one destination to another. Personal grounding is to be worn at all times when handling these devices.

For more details, refer to Avago Technologies Application Note A004R: Electrostatic Discharge Damage and Control. ESD Machine Model (Class A) ESD Human Body Model (Class 0)

AMMC-6231 DC Specifications/Physical Properties [1]

Symbol	Parameters and Test Conditions	Units	Min.	Typ.	Max.
I_d	Drain Supply Current (under any RF power drive and temperature) ($V_d=3.0V$)	mA		60	80
θ_{ch-b}	Thermal Resistance ^[2] (Backside temperature, $T_b = 25^\circ C$)	$^\circ C/W$		25	

AMMC-6231 RF Specifications [3, 4, 5]

$T_A = 25^\circ C$, $V_d = 3.0V$, $I_d(Q) = 60mA$, $Z_{in} = Z_o = 50\ \Omega$

Symbol	Parameters and Test Conditions	Units	Minimum	Typical	Maximum	Sigma
Gain	Small-signal Gain ^[6]	dB	20	22		0.4
NF	Noise Figure into 50 Ω	dB		18-28 GHz = 2.5 28-32 GHz = 2.7	18-28 GHz = 2.8 28-32 GHz = 2.9	0.1
P_{-1dB}	Output Power at 1dB Gain Compression	dBm		+8.5		
OIP3	Third Order Intercept Point; Df=100MHz; Pin=-35dBm	dBm		+19		
RLin	Input Return Loss ^[6]	dB		-9	-8	0.3
RLout	Output Return Loss ^[6]	dB		-16	-12	0.5

Notes:

1. Ambient operational temperature $T_A = 25^\circ C$ unless otherwise noted.
2. Channel-to-backside Thermal Resistance (q_{ch-b}) = $26^\circ C/W$ at $T_{channel} (T_c) = 34^\circ C$ as measured using infrared microscopy. Thermal Resistance at backside temperature (T_b) = $25^\circ C$ calculated from measured data.
3. Small/Large -signal data measured in wafer form $T_A = 25^\circ C$.
4. 100% on-wafer RF test is done at frequency = 18, 26, and 31 GHz.
5. Specifications are derived from measurements in a 50 Ω test environment. Aspects of the amplifier performance may be improved over a more narrow bandwidth by application of additional conjugate, linearity, or low noise (Gopt) matching.
6. As derived from measured s-parameters

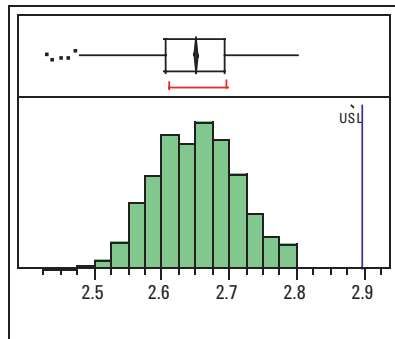

Noise Figure at 31 GHz

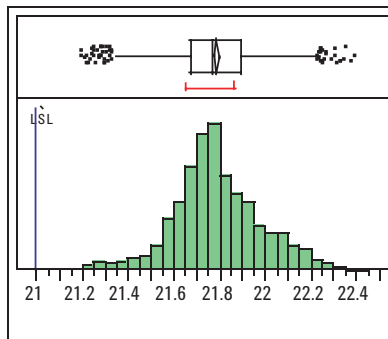

Noise Figure at 26 GHz

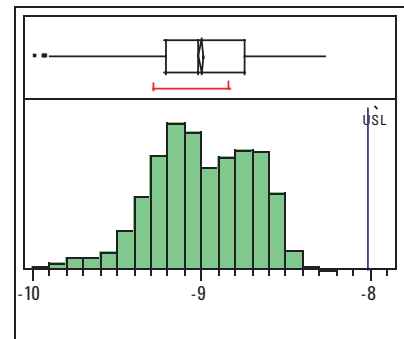

S11 at 31GHz

Typical distribution of Small Signal Gain, Noise Figure, and Return Loss. Based on 1500 part sampled over several production lots.

AMMC-6231 Typical Performances

($T_A = 25^\circ\text{C}$, $V_{d1} = V_{d2} = 3.0\text{ V}$, $I_{\text{total}} = 60\text{ mA}$, $Z_{\text{in}} = Z_{\text{out}} = 50\ \Omega$ unless otherwise stated)

NOTE: These measurements are in a $50\ \Omega$ test environment. Aspects of the amplifier performance may be improved over a narrower bandwidth by application of additional conjugate, linearity, or low noise (Gopt) matching

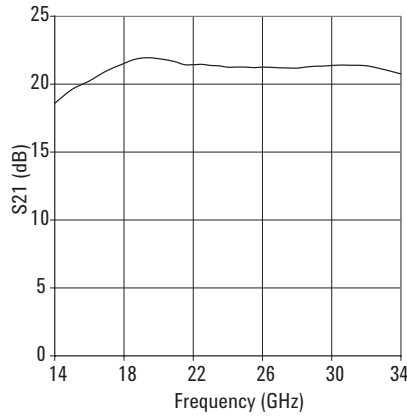

Figure 1. Typical Gain

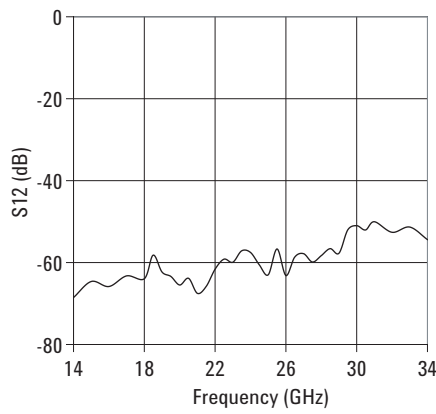

Figure 2. Typical Isolation

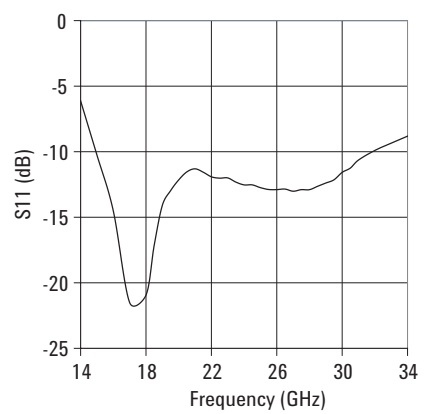

Figure 3 Typical Input Return Loss

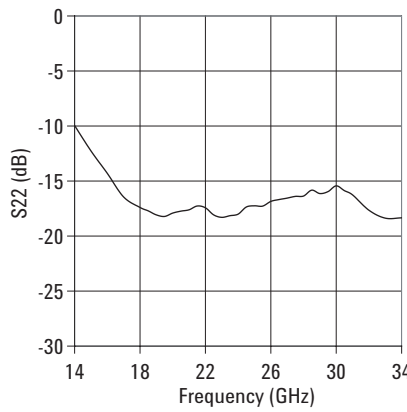

Figure 4. Typical Output Return Loss

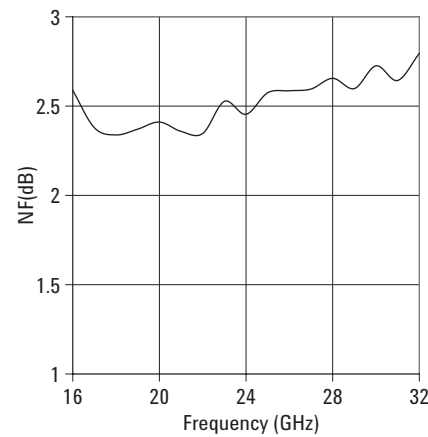

Figure 5. Typical Noise Figure into a $50\ \Omega$ load.

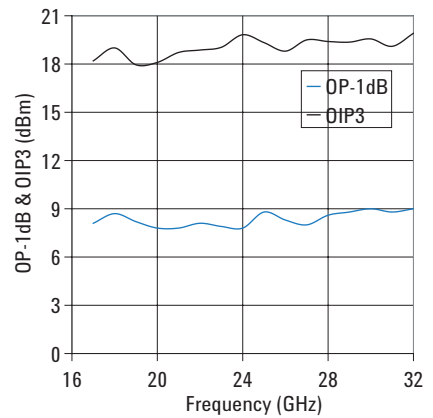

Figure 6. Typical Output P-1dB and 3rd Order Intercept Pt.

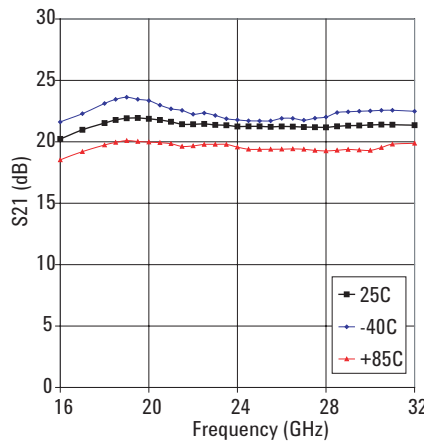

Figure 7. Gain Over Temperature

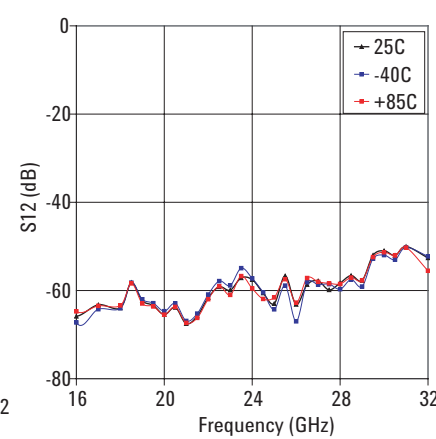

Figure 8. Isolation Over Temperature

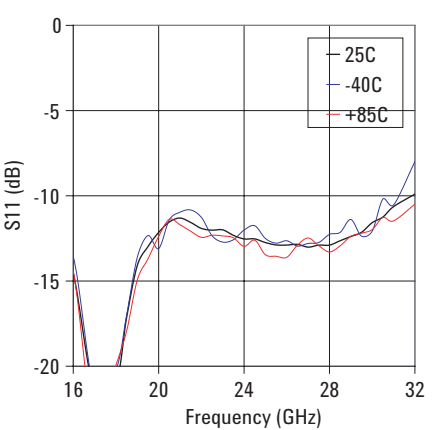

Figure 9. Typical Input Return Loss Over Temperature

AMMC-6231 Typical Performances

($T_A = 25^\circ\text{C}$, $V_{d1}=V_{d2}=3.0\text{ V}$, $I_{\text{total}} = 60\text{ mA}$, $Z_{\text{in}} = Z_{\text{out}} = 50\ \Omega$ unless otherwise stated)

NOTE: These measurements are in a $50\ \Omega$ test environment. Aspects of the amplifier performance may be improved over a narrower bandwidth by application of additional conjugate, linearity, or low noise (Gopt) matching.

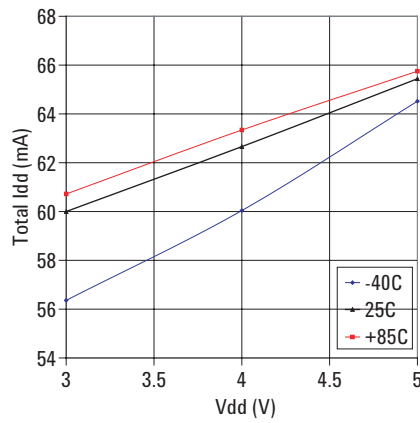

Figure 10: Total Idd Over Temperature

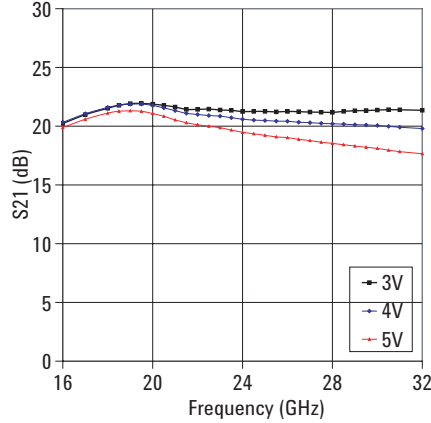

Figure 11: Gain Over Vdd

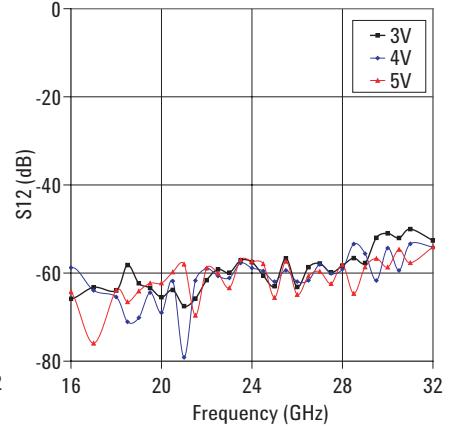

Figure 12: Isolation over Vdd

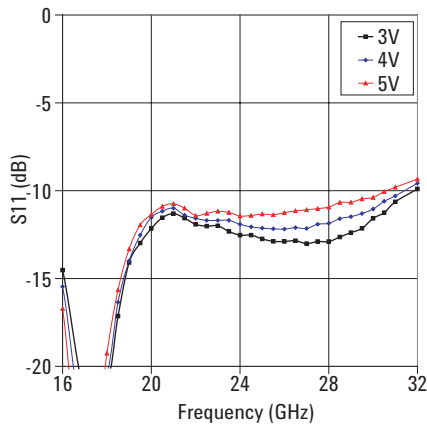

Figure 13: Input Return Loss Over Vdd

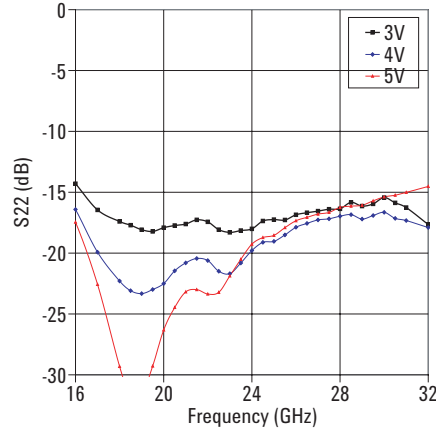

Figure 14: Output Return Loss Over Vdd

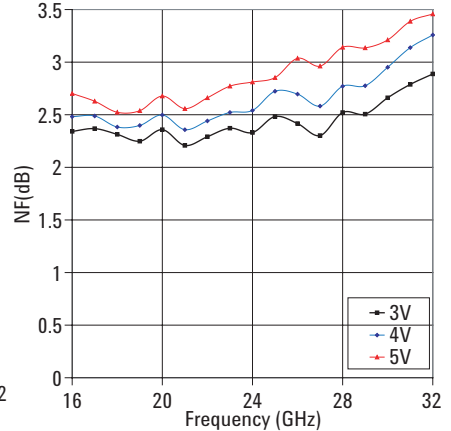

Figure 15: Noise Figure Over Vdd

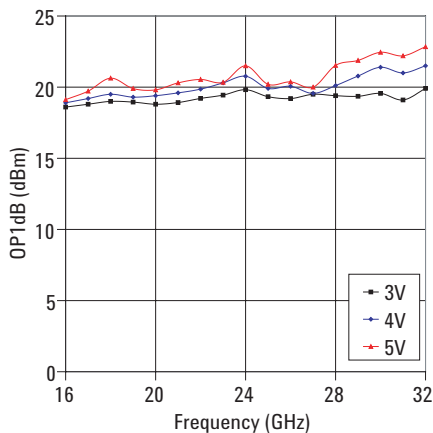

Figure 16: Output IP3 Over Vdd

AMMC-6231 Typical Scattering Parameters¹ ($T_C=25^\circ\text{C}$, $V_{D1}=V_{D2}=3\text{ V}$, $I_{\text{total}}=60\text{ mA}$ $Z_{\text{in}}=Z_{\text{out}}=50\ \Omega$)

Note: Data obtained from on-wafer measurements

Freq GHz	S11			S21			S12			S22		
	dB	Mag	Phase	dB	Mag	Phase	dB	Mag	Phase	dB	Mag	Phase
11	-1.224	0.869	169.751	-2.168	0.779	47.164	-68.269	0	-45.116	-4.672	0.584	-131.79
12	-1.52	0.839	149.847	7.264	2.308	-28.78	-64.182	0.001	178.21	-6.096	0.496	-143.113
13	-2.67	0.735	123.576	14.773	5.479	-106.707	-69.718	0	-1.991	-7.796	0.408	-153.93
14	-6.127	0.494	98.304	18.596	8.507	171.105	-68.541	0	179.486	-9.961	0.318	-161.328
15	-10.264	0.307	84.852	19.615	9.566	103.508	-64.621	0.001	148.061	-12.266	0.244	-166.179
16	-14.521	0.188	65.726	20.236	10.276	49.585	-65.844	0.001	125.856	-14.301	0.193	-165.809
16.5	-17.105	0.14	52.122	20.627	10.749	24.834	-66.45	0	39.923	-15.351	0.171	-164.958
17	-21.512	0.084	23.785	20.979	11.193	0.992	-63.247	0.001	162.79	-16.452	0.15	-161.912
17.5	-23.536	0.067	-18.771	21.237	11.531	-21.976	-66.021	0.001	0.751	-17.137	0.139	-156.931
18	-20.946	0.09	-71.637	21.524	11.918	-44.291	-63.95	0.001	112.065	-17.399	0.135	-154.425
18.5	-17.139	0.139	-99.62	21.779	12.273	-65.931	-58.189	0.001	76.722	-17.706	0.13	-152.65
19	-14.086	0.198	-121.971	21.917	12.47	-87.85	-62.31	0.001	53.429	-18.078	0.125	-149.878
19.5	-12.981	0.224	-138.557	21.941	12.504	-108.946	-63.387	0.001	-27.327	-18.219	0.123	-145.515
20	-12.151	0.247	-148.771	21.873	12.407	-128.605	-65.475	0.001	-71.93	-17.911	0.127	-143.752
20.5	-11.537	0.265	-158.049	21.776	12.269	-147.868	-63.841	0.001	19.483	-17.733	0.13	-142.2
21	-11.306	0.272	-168.343	21.632	12.067	-166.171	-67.516	0	21.783	-17.612	0.132	-143.646
21.5	-11.563	0.264	-174.869	21.433	11.793	177.01	-65.795	0.001	-9.861	-17.27	0.137	-144.727
22	-11.914	0.254	-178.065	21.43	11.789	160.276	-61.616	0.001	-168.107	-17.431	0.134	-148.407
22.5	-12.017	0.251	179.655	21.456	11.825	144.048	-59.172	0.001	-157.925	-18.073	0.125	-147.601
23	-11.999	0.251	177.242	21.377	11.718	127.893	-59.916	0.001	173.807	-18.298	0.122	-145.456
23.5	-12.322	0.242	175.484	21.348	11.679	112.058	-57.137	0.001	159.917	-18.148	0.124	-144.058
24	-12.532	0.236	173.191	21.248	11.546	96.99	-57.535	0.001	148.235	-18.008	0.126	-141.442
24.5	-12.53	0.236	171.601	21.258	11.558	82.291	-60.568	0.001	125.011	-17.361	0.136	-142.706
25	-12.744	0.231	172.328	21.257	11.557	67.06	-62.987	0.001	136.388	-17.249	0.137	-145.709
25.5	-12.883	0.227	171.212	21.218	11.506	52.687	-56.686	0.001	137.081	-17.278	0.137	-146.019
26	-12.891	0.227	171.982	21.251	11.55	38.166	-63.159	0.001	93.342	-16.853	0.144	-147.033
26.5	-12.85	0.228	172.072	21.236	11.529	23.556	-58.666	0.001	131.485	-16.682	0.147	-150.378
27	-13.013	0.224	171.665	21.201	11.483	9.169	-57.833	0.001	131.41	-16.552	0.149	-152.151
27.5	-12.893	0.227	172.97	21.19	11.468	-4.75	-59.86	0.001	117.672	-16.393	0.151	-155.696
28	-12.895	0.227	174.43	21.178	11.453	-18.352	-58.302	0.001	140.189	-16.364	0.152	-156.583
28.5	-12.636	0.233	178.289	21.259	11.56	-32.627	-56.608	0.001	111.274	-15.83	0.162	-160.401
29	-12.387	0.24	176.849	21.316	11.636	-46.562	-57.721	0.001	112.031	-16.138	0.156	-164.619
29.5	-12.143	0.247	177.181	21.331	11.656	-60.321	-52.001	0.003	120.164	-15.957	0.159	-166.799
30	-11.576	0.264	178.961	21.372	11.711	-74.237	-50.993	0.003	116.245	-15.438	0.169	-172.729
30.5	-11.248	0.274	179.288	21.403	11.753	-88.063	-52.041	0.003	81.089	-15.872	0.161	-179.133
31	-10.636	0.294	178.61	21.393	11.739	-102.278	-50.028	0.003	90.796	-16.26	0.154	175.844
32	-9.902	0.32	176.368	21.353	11.685	-130.188	-52.61	0.002	45.032	-17.652	0.131	170.562
33	-9.35	0.341	171.82	21.083	11.327	-158.564	-51.333	0.003	57.174	-18.373	0.121	167.809
34	-8.813	0.363	171.094	20.755	10.908	175.593	-54.399	0.002	65.576	-18.344	0.121	170.267
35	-8.125	0.392	172.451	20.532	10.632	149.898	-55.336	0.002	20.73	-18.098	0.124	168.084
36	-6.991	0.447	171.322	20.41	10.484	124.13	-63.736	0.001	34.727	-17.898	0.127	158.553
37	-5.494	0.531	167.843	20.277	10.324	97.564	-58.775	0.001	-10.016	-17.799	0.129	151.639
38	-4.281	0.611	160.315	19.935	9.925	69.896	-49.909	0.003	43.736	-18.436	0.12	147.104
39	-3.26	0.687	152.777	19.443	9.379	42.889	-50.435	0.003	30.726	-18.59	0.118	144.621
40	-2.305	0.767	144.157	18.863	8.773	15.719	-47.535	0.004	-7.216	-17.849	0.128	136.198
41	-1.513	0.84	134.565	18.019	7.96	-11.114	-47.208	0.004	-6.051	-17.478	0.134	122.522
42	-0.772	0.915	123.324	17.035	7.108	-38.077	-48.23	0.004	-16.155	-18.008	0.126	115.316
43	-0.343	0.961	112.897	15.871	6.216	-63.626	-48.224	0.004	-64.239	-18.233	0.123	103.928
44	-0.275	0.969	100.29	14.549	5.339	-88.002	-51.952	0.003	-98.825	-18.451	0.12	93.181
45	-0.349	0.961	89.671	13.18	4.56	-111.566	-47.621	0.004	-132.254	-18.869	0.114	83.6

AMMC-6231 Typical Scattering Parameters¹ ($T_C=25^\circ\text{C}$, $V_{D1}=V_{D2}=5\text{ V}$, $I_{\text{total}}=65\text{ mA}$, $Z_{\text{in}}=Z_{\text{out}}=50\ \Omega$)

Note: Data obtained from on-wafer measurements

Freq GHz	S11			S21			S12			S22		
	dB	Mag	Phase	dB	Mag	Phase	dB	Mag	Phase	dB	Mag	Phase
11	-1.274	0.864	170.496	-4.446	0.599	46.906	-62.427	0.001	-156.271	-4.57	0.591	-136.719
12	-1.686	0.824	150.794	5.539	1.892	-27.167	-70.07	0	146.571	-6.069	0.497	-150.437
13	-2.969	0.71	124.827	13.758	4.874	-105.528	-73.152	0	-24.365	-7.93	0.401	-164.641
14	-6.818	0.456	99.979	18.14	8.073	167.923	-68.541	0	-112.644	-10.618	0.295	-177.769
15	-11.381	0.27	88.861	19.224	9.146	96.994	-63.748	0.001	177.801	-13.733	0.206	171.93
16	-16.706	0.146	71.089	19.888	9.872	40.549	-64.261	0.001	-105.733	-17.456	0.134	165.294
16.5	-21.13	0.088	54.844	20.214	10.249	14.975	-66.021	0.001	-177.622	-19.798	0.102	164.208
17	-28.509	0.038	10.753	20.589	10.702	-10.127	-75.948	0	-69.734	-22.575	0.074	163.37
17.5	-24.565	0.059	-80.986	20.863	11.044	-34.405	-62.673	0.001	87.684	-25.784	0.051	169.587
18	-19.254	0.109	-106.949	21.114	11.369	-58.16	-63.899	0.001	99.296	-29.307	0.034	-174.356
18.5	-15.649	0.165	-121.039	21.269	11.573	-80.967	-66.548	0	-57.445	-31.86	0.026	-153.056
19	-13.321	0.216	-133.732	21.308	11.625	-103.642	-64.119	0.001	65.134	-31.679	0.026	-116.209
19.5	-11.95	0.253	-145.615	21.266	11.57	-125.723	-62.304	0.001	25.072	-29.276	0.034	-95.762
20	-11.351	0.271	-156.055	21.076	11.319	-146.826	-62.298	0.001	105.846	-26.317	0.048	-84.659
20.5	-10.896	0.285	-164.209	20.839	11.014	-166.524	-59.782	0.001	99.542	-24.464	0.06	-85.624
21	-10.743	0.29	-171.309	20.536	10.636	174.575	-58.005	0.001	29.812	-23.189	0.069	-86.727
21.5	-10.995	0.282	-176.013	20.292	10.342	156.985	-69.607	0	-57.692	-23.002	0.071	-89.283
22	-11.414	0.269	-177.861	20.125	10.145	140.534	-58.866	0.001	-72.244	-23.362	0.068	-91.514
22.5	-11.291	0.273	-179.031	19.998	9.998	124.072	-60.086	0.001	-161.093	-23.22	0.069	-82.171
23	-11.171	0.276	178.842	19.869	9.851	106.958	-63.378	0.001	-147.709	-21.875	0.081	-75.78
23.5	-11.24	0.274	177.701	19.674	9.632	90.996	-57.019	0.001	-168.211	-20.509	0.094	-75.352
24	-11.442	0.268	175.886	19.483	9.423	75.675	-57.313	0.001	142.759	-19.265	0.109	-77.135
24.5	-11.413	0.269	174.866	19.354	9.283	60.442	-57.907	0.001	160.988	-18.723	0.116	-82.146
25	-11.331	0.271	174.63	19.221	9.142	45.49	-65.563	0.001	148.737	-18.542	0.118	-83.347
25.5	-11.369	0.27	173.89	19.095	9.011	30.836	-57.356	0.001	148.202	-17.909	0.127	-84.462
26	-11.248	0.274	173.447	19.023	8.936	16.186	-64.895	0.001	147	-17.342	0.136	-87.417
26.5	-11.148	0.277	172.027	18.884	8.794	1.694	-60.673	0.001	116.872	-17.06	0.14	-90.365
27	-11.09	0.279	172.311	18.776	8.686	-12.139	-59.647	0.001	127.765	-16.797	0.145	-92.536
27.5	-11.021	0.281	171.687	18.637	8.548	-26.291	-62.419	0.001	173.035	-16.657	0.147	-93.932
28	-10.934	0.284	170.556	18.538	8.451	-40.108	-58.1	0.001	154.113	-16.245	0.154	-95.894
28.5	-10.669	0.293	171.414	18.422	8.339	-53.711	-64.651	0.001	89.451	-16.14	0.156	-98.652
29	-10.658	0.293	169.83	18.308	8.23	-67.235	-58.638	0.001	118.727	-16.071	0.157	-98.432
29.5	-10.47	0.3	170.126	18.206	8.134	-80.621	-56.694	0.001	155.781	-15.706	0.164	-100.324
30	-10.384	0.303	170.606	18.106	8.041	-93.727	-58.675	0.001	136.937	-15.384	0.17	-103.635
30.5	-10.054	0.314	170.547	17.957	7.904	-106.755	-54.652	0.002	106.666	-15.24	0.173	-104.558
31	-9.805	0.323	169.344	17.835	7.794	-119.437	-57.676	0.001	119.455	-15.011	0.178	-105.433
32	-9.335	0.341	166.637	17.654	7.633	-145.275	-54.093	0.002	95.531	-14.522	0.188	-107.414
33	-8.938	0.357	164.399	17.262	7.296	-169.829	-53.735	0.002	32.768	-13.824	0.204	-111.234
34	-8.73	0.366	163.933	16.94	7.031	166.626	-67.835	0	164.557	-12.655	0.233	-117.582
35	-8.386	0.381	164.222	16.819	6.934	144.945	-58.654	0.001	153.048	-12.348	0.241	-124.755
36	-7.616	0.416	166.305	16.92	7.015	122.97	-58.632	0.001	129.804	-12.297	0.243	-130.333
37	-6.386	0.479	164.858	17.196	7.241	99.591	-54.446	0.002	128.707	-11.875	0.255	-136.111
38	-5.174	0.551	161.864	17.375	7.392	75.612	-55.897	0.002	120.92	-11.409	0.269	-141.724
39	-4.1	0.624	158.245	17.715	7.687	50.891	-51.032	0.003	77.587	-10.873	0.286	-146.547
40	-2.71	0.732	153.014	18.141	8.073	25.237	-50.741	0.003	92.832	-10.333	0.304	-154.439
41	-1.282	0.863	146.069	18.403	8.321	-2.083	-49.135	0.003	65.101	-10.118	0.312	-162.794
42	-0.755	0.917	135.682	18.675	8.585	-32.624	-45.441	0.005	64.787	-9.44	0.337	-170.419
43	-0.381	0.957	121.916	18.55	8.463	-65.229	-47.899	0.004	26.462	-9.082	0.351	-179.247
44	-0.913	0.9	106.699	17.677	7.653	-99.381	-46.446	0.005	14.717	-8.921	0.358	167.908
45	-0.111	0.987	91.299	16.124	6.4	-130.994	-45.355	0.005	-12.481	-8.945	0.357	155.89

Biasing and Operation

The AMMC-6231 is normally biased with a positive supply connected to both V_{D1} and V_{D2} bond pads through the 100pF bypass capacitor as shown in Figure 21. The recommended supply voltage is 3 V. It is important to place the bypass capacitor as close to the die as possible. No negative gate bias voltage is needed for the AMMC-6231. Input and output matching are achieved on-die, therefore no other external component is required besides one 100pF bypass capacitor for the main supply. The input and output are DC-blocked with internal coupling capacitors.

No ground wires are needed because all ground connections are made with plated through-holes to the backside of the device.

Refer the Absolute Maximum Ratings table for allowed DC and thermal conditions.

Assembly Techniques

The backside of the MMIC chip is RF ground. For microstrip applications the chip should be attached directly to the ground plane (e.g. circuit carrier or heatsink) using electrically conductive epoxy^[1,2]

For best performance, the topside of the MMIC should be brought up to the same height as the circuit surrounding it. This can be accomplished by mounting a gold plate metal shim (same length and width as the MMIC) under the chip which is of correct thickness to make the chip and adjacent circuit the same height. The amount of epoxy used for the chip and/or shim attachment should be just enough to provide a thin fillet around the bottom perimeter of the chip or shim. The ground plan should be free of any residue that may jeopardize electrical or mechanical attachment.

The location of the RF bond pads is shown in Figure 12. Note that all the RF input and output ports are in a Ground-Signal-Ground configuration.

RF connections should be kept as short as reasonable to minimize performance degradation due to undesirable series inductance. A single bond wire is normally sufficient for signal connections, however double bonding with 0.7 mil gold wire or use of gold mesh is recommended for best performance, especially near the high end of the frequency band.

Thermosonic wedge bonding is preferred method for wire attachment to the bond pads. Gold mesh can be attached using a 2 mil round tracking tool and a tool force of approximately 22 grams and a ultrasonic power of roughly 55 dB for a duration of 76 +/- 8 mS. The guided wedge at an ultrasonic power level of 64 dB can be used for 0.7 mil wire. The recommended wire bond stage temperature is 150 +/- 2C.

Caution should be taken to not exceed the Absolute Maximum Rating for assembly temperature and time.

The chip is 100um thick and should be handled with care. This MMIC has exposed air bridges on the top surface and should be handled by the edges or with a custom collet (do not pick up the die with a vacuum on die center).

This MMIC is also static sensitive and ESD precautions should be taken

Notes:

1. Ablebond 84-1 LM1 silver epoxy is recommended.
2. Eutectic attach is not recommended and may jeopardize reliability of the device.

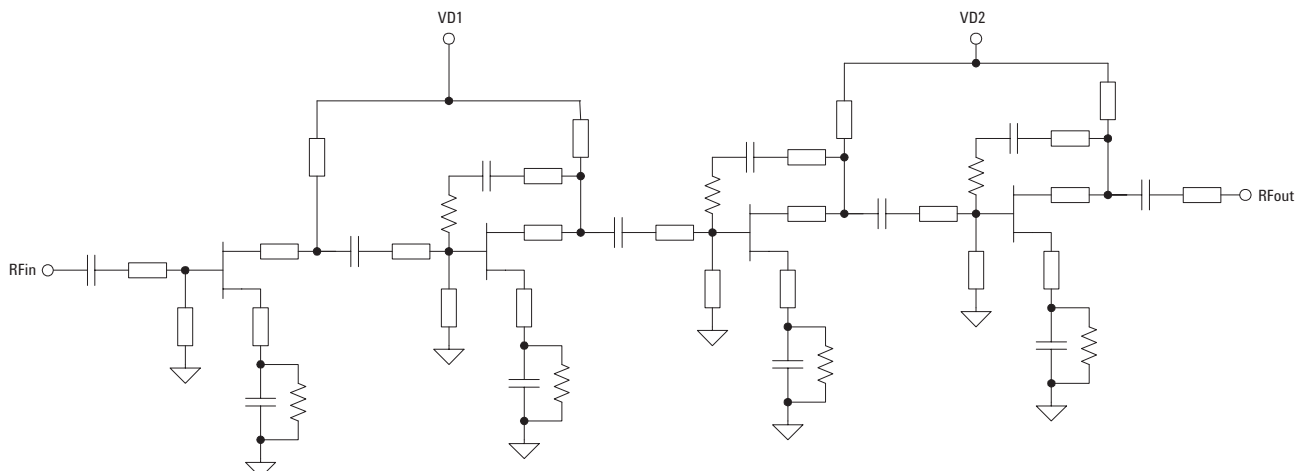

Figure 17. AMMC-6231 Simplified Schematic

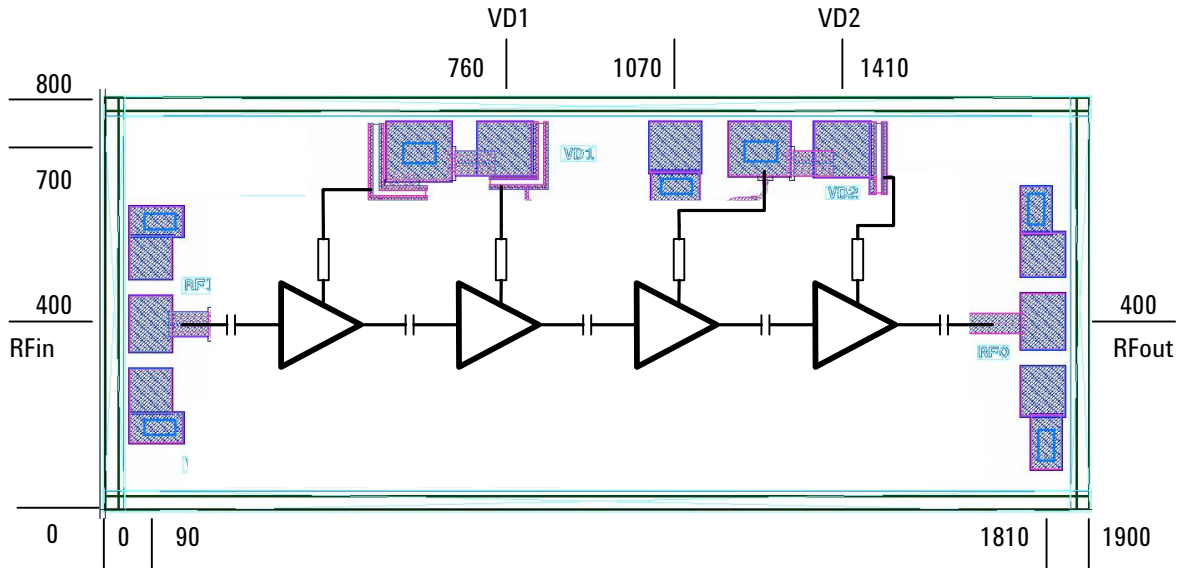

Figure 18. AMMC-6231 Bonding pad locations

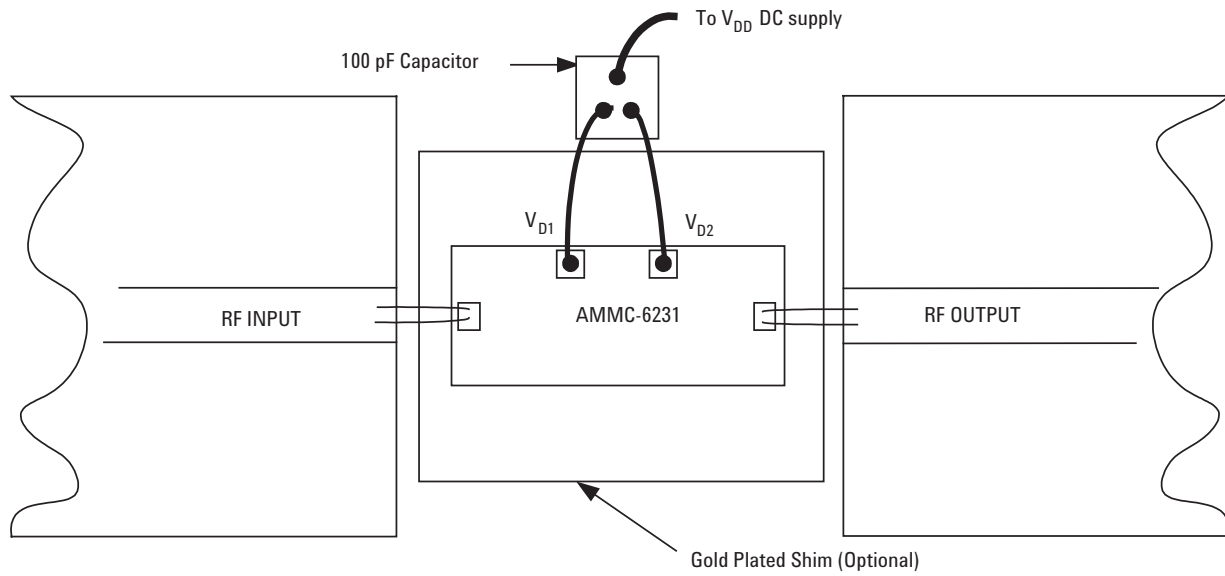

Figure 19. AMMC-6231 Assembly diagram

Ordering Information:

AMMC-6231-W10 = 10 devices per tray

AMMC-6231-W50 = 50 devices per tray

For product information and a complete list of distributors, please go to our web site: www.avagotech.com

Avago, Avago Technologies, and the A logo are trademarks of Avago Technologies Limited in the United States and other countries. Data subject to change. Copyright © 2005-2008 Avago Technologies Limited. All rights reserved. Obsoletes 5989-3942EN AV02-1288EN - June 23, 2008

