



*Representative photograph, actual product appearance may vary.*

*Due to regional agency approval requirements, some products may not be available in your area. Please contact your regional Honeywell office regarding your product of choice.*

## **590SX1N56S502SP**

**590 Series Commercial Potentiometer, Conductive Plastic Element, PC Terminals, 0.5 W Power Rating, 5 kOhm Resistance Value**

### **Features**

- Compact - 12,7 mm [0.5 in] modular size
- Robust - Brass shaft and bushings
- Conductive plastic element
- Linear taper
- PC style terminals

### **Typical Applications**

- Manual controls
- Welding and heating
- Telecommunications

### **Description**

The 590 Series is a low cost potentiometer with the benefits of a conductive plastic element. It offers a 1/2 watt power rating and a metal shaft and bushing.

## **590SX1N56S502SP**

**590 Series Commercial Potentiometer, Conductive Plastic Element, PC Terminals, 0.5 W Power Rating, 5 kOhm Resistance Value**

**Product Specifications**

<b>Potentiometer Type</b>	Commercial
<b>Element Type</b>	Conductive Plastic
<b>Terminal Type</b>	PC
<b>Power Rating</b>	0.5 W
<b>Resistance Value</b>	5 kOhm
<b>Resistance Tolerance</b>	± 10 %
<b>Linearity</b>	± 5 %
<b>Bushing Thread</b>	6,35 mm [0.25 in] x 32 NEF-2A
<b>Bushing length</b>	6,35 mm [0.25 in]
<b>Bushing Type</b>	Standard
<b>Shaft Diameter</b>	3,18 mm [0.125 in]
<b>Shaft length</b>	22,22 mm [0.875 in]
<b>Shaft Ending</b>	Slotted
<b>Body</b>	12.7 mm [0.5 in] square, ± 0.79 mm [0.031 in]
<b>Electrical Taper</b>	Linear
<b>Operating Temperature</b>	-40 °C to 120 °C [-40 °F to 248 °F]
<b>Working Voltage (Max.)</b>	350 V
<b>Rotational Life</b>	50000 cycles
<b>Mechanical Rotation</b>	295°
<b>Availability</b>	Global
<b>Series Name</b>	590 Series
<b>UNSPSC Code</b>	4111363300
<b>UNSPSC Commodity</b>	4111363300 Potentiometers

# Honeywell

## 590SX1N56S502SP

590 Series Commercial Potentiometer, Conductive Plastic Element, PC Terminals, 0.5 W Power Rating, 5 kOhm Resistance Value

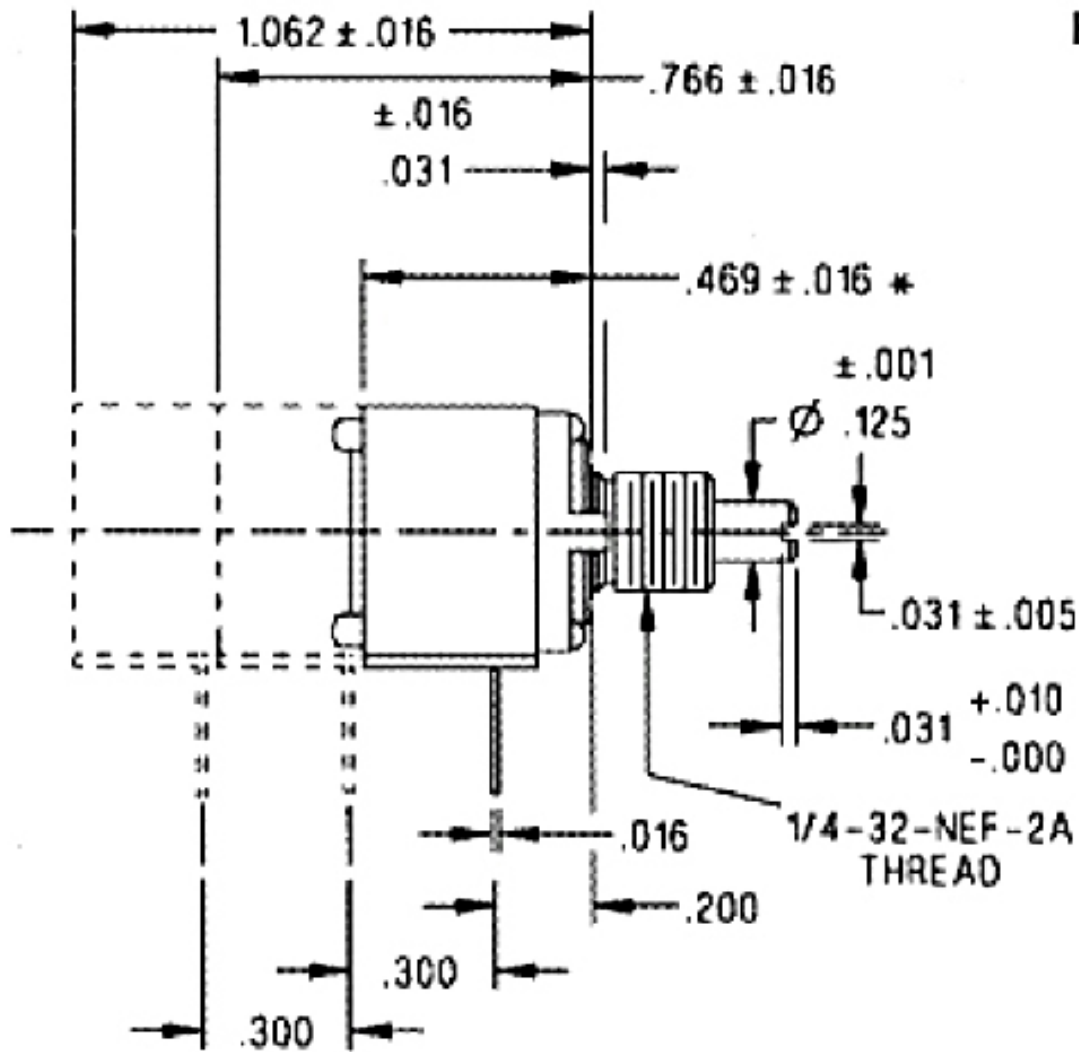

For Reference Only

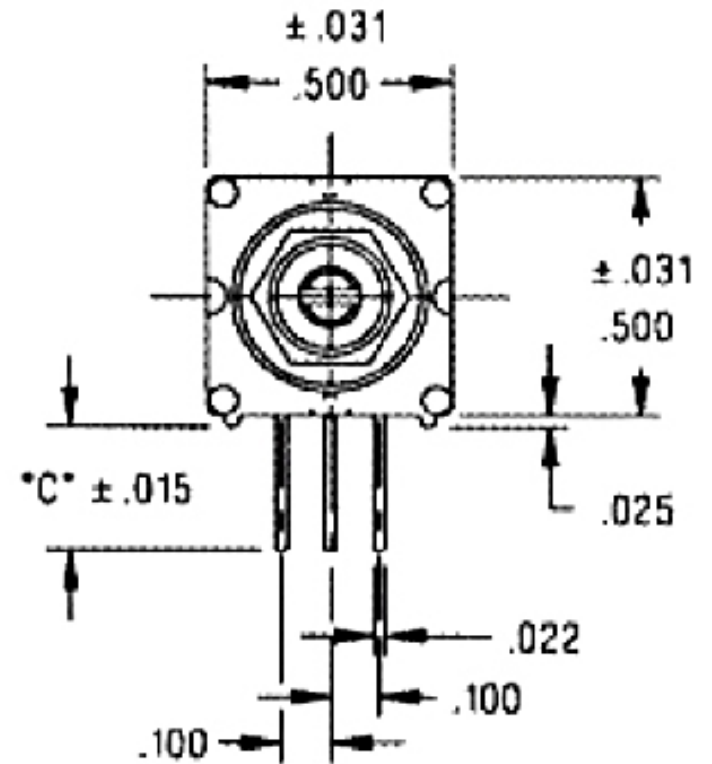

**Honeywell**

**590SX1N56S502SP**

590 Series Commercial Potentiometer, Conductive Plastic Element, PC Terminals, 0.5 W Power Rating, 5 kOhm Resistance Value

** WARNING**

**PERSONAL INJURY**

DO NOT USE these products as safety or emergency stop devices, or in any other application where failure of the product could result in personal injury.

**Failure to comply with these instructions could result in death or serious injury.**

** WARNING**

**MISUSE OF DOCUMENTATION**

- The information presented in this product sheet (or catalog) is for reference only. DO NOT USE this document as product installation information.
- Complete installation, operation and maintenance information is provided in the instructions supplied with each product.

**Failure to comply with these instructions could result in death or serious injury.**