

Surface Mount Multi-Functional DIP Switch IR Solderable, PCB Washable

Features

Optimized Mechanical Features

- Coplanarity: 0.1mm / .004" max.
- Compatible with SMT assembly including IR and Vapor-Phase (up to 260°C)
- Enclosed actuators shield contacts from foreign particles throughout life of switch
- Gull-wing terminal configurations
- Available with SPST, SPDT, DPST, 3PST circuitry choices

Optimized Contact System

- Contact wiping action on make and break
- Integral terminal and contact locked into thermoset base
- Available with low profile, standard, or extended actuators
- Electrostatic discharge shield rated to 22 KV

Materials

- Gold plated contacts for long-term contact corrosion resistance
- All UL 94 V-0 plastics used
- RoHS compliant
- Optional top tape seal for board spray washing

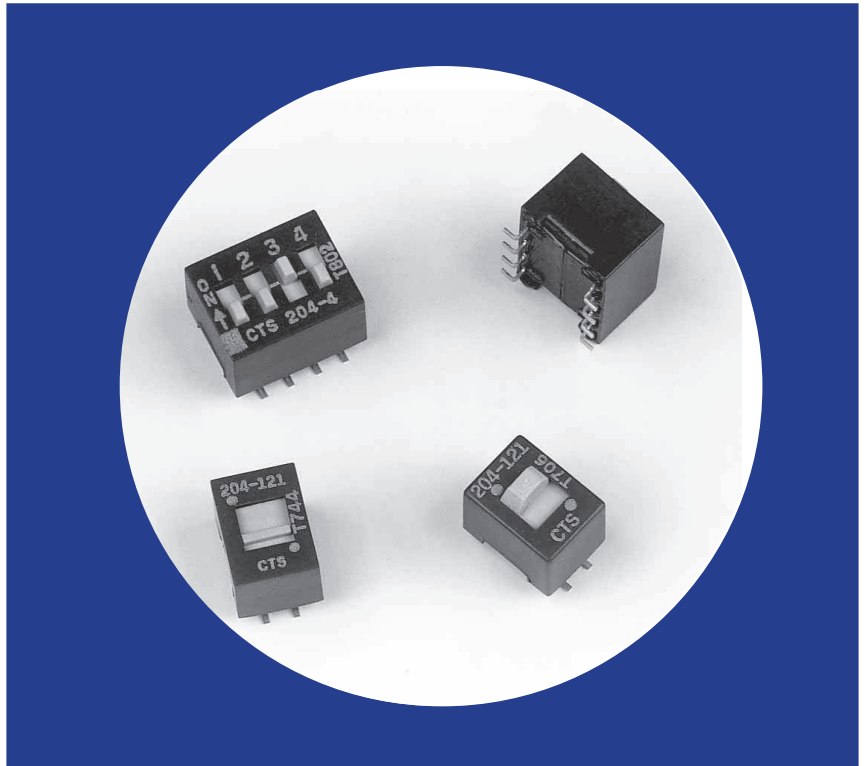

Electrical and Mechanical Specifications

Switch Function

- SPST - 2 through 10 and 12 positions
- SPDT & DPST - 1 through 6 positions
- 3PST - 1 through 4 positions

Contact Resistance

- 50 milliohms maximum initial
- 100 milliohms maximum at end of life

Insulation Resistance

- 1,000 megohms minimum between insulated terminals

Dielectric Strength

- 500 VAC for 1 minute between adjacent switches

Nonswitching Rating

- 100 mA or 50 VDC maximum

Switch Capacitance

- 5 pF maximum between adjacent closed switches

Operating Temperature

- 55°C to +85°C

Actuation Life

- 5,000 cycles switching 50 mA @ 24 VDC

Coplanarity

- 0.1mm/.004" max.

Allowable Solder Time

- Up to 60 seconds at 260°C

Vibration

- Per MIL-STD-202F, method 204D, condition B (.06" or 15 G's between 10 Hz to 2K Hz) with no contact inconsistencies greater than 1 microsecond

Shock

- Per MIL-STD-202F, method 213B, condition A (50 G's) with no contact inconsistencies greater than 1 microsecond

Sealing

- Bottom epoxy seal optional
- Optional top tape seal for board spray washing

Marking

- Special side or top marking available - consult CTS

Packaging

- Standard : Anti-static tube packaging
- Optional : Tape and reel packaging

SPST

SCHEMATIC



Ordering Information SPST Switches

"A" Overall Dimension	No. of Switch Positions	Part No.
7.26 / .286	2	204-2
9.80 / .386	3	204-3
12.34 / .486	4	204-4
14.88 / .586	5	204-5
17.42 / .686	6	204-6
19.96 / .786	7	204-7
22.50 / .886	8	204-8
25.04 / .986	9	204-9
27.58 / 1.086	10	204-10
32.66 / 1.286	12	204-12

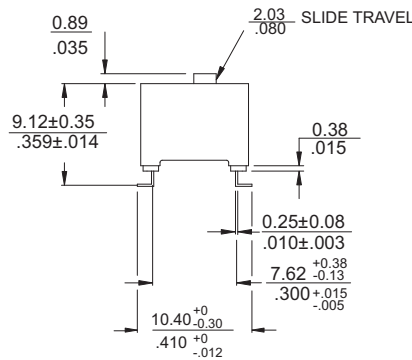
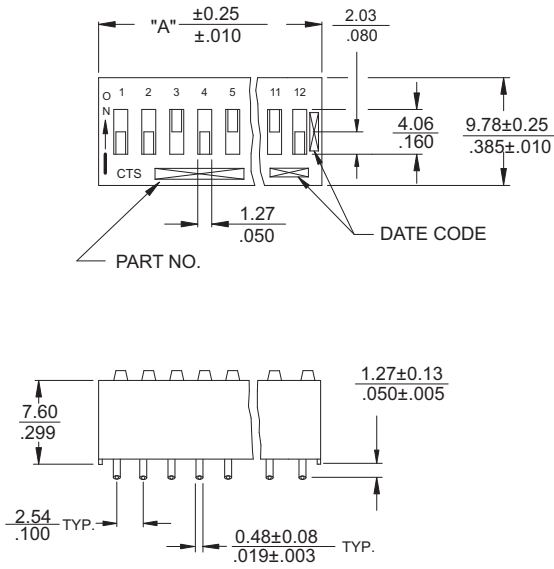

DIMENSION: $\frac{\text{mm}}{\text{inch}}$

SPDT / DPST

Ordering Information SPDT/DPST Switches

"A" Overall Dimension	Number of Switch Positions	Actuation	Part No.
7.26 / .286	1	SPDT/DPST	204-121/204-211
12.34 / .486	2	SPDT/DPST	204-122/204-212
17.42 / .686	3	SPDT/DPST	204-123/204-213
22.50 / .886	4	SPDT/DPST	204-124/204-214
27.58 / 1.086	5	SPDT/DPST	204-125/204-215
32.66 / 1.286	6	SPDT/DPST	204-126/204-216

SPDT

SCHEMATIC

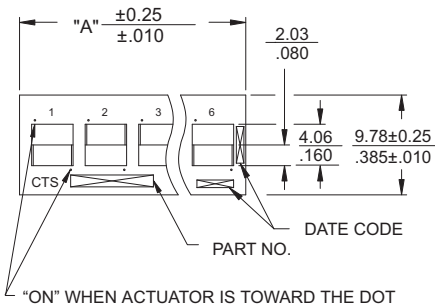

DPST

SCHEMATIC

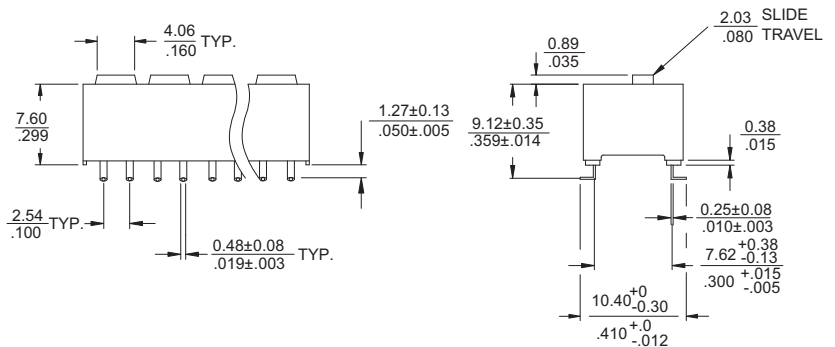
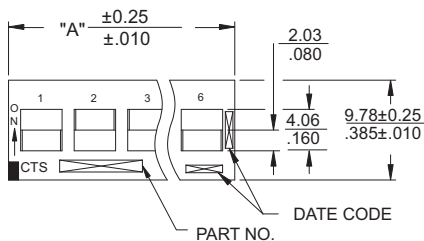

DIMENSION: $\frac{\text{mm}}{\text{inch}}$

3PST

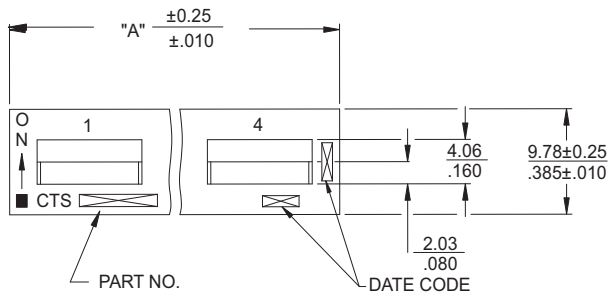

SCHEMATIC



Ordering Information 3PST Switches

"A" Overall Dimension	No. of Switch Positions	Actuation	Part No.
9.80 / .386	1	3PST	204-311
17.42 / .686	2	3PST	204-312
25.04 / .986	3	3PST	204-313
32.66 / 1.286	4	3PST	204-314

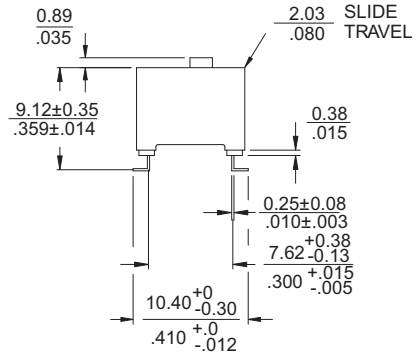
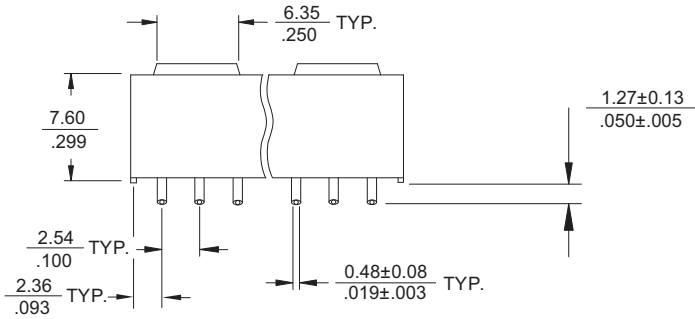

DIMENSION: $\frac{\text{mm}}{\text{inch}}$

Low Profile Actuators (Available in SPST and SPDT)

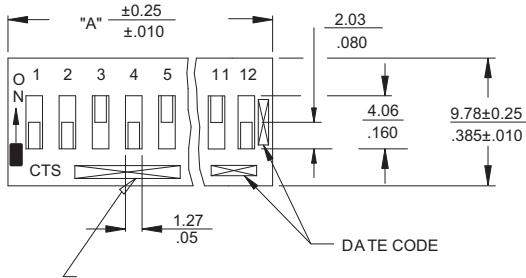

SURFACE MOUNT PAD LAYOUTS (ALL STYLES)

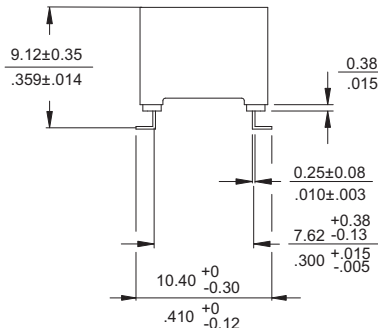
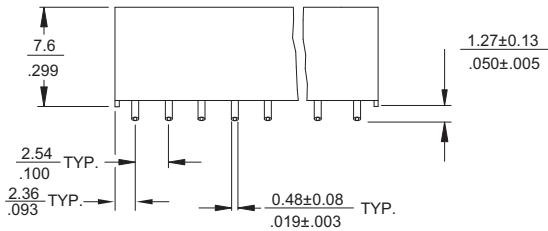
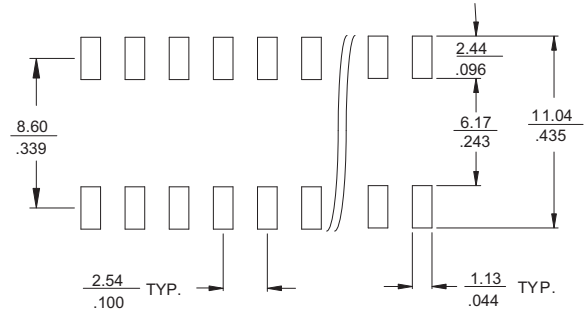

DIMENSION: $\frac{\text{mm}}{\text{inch}}$

Ordering Information

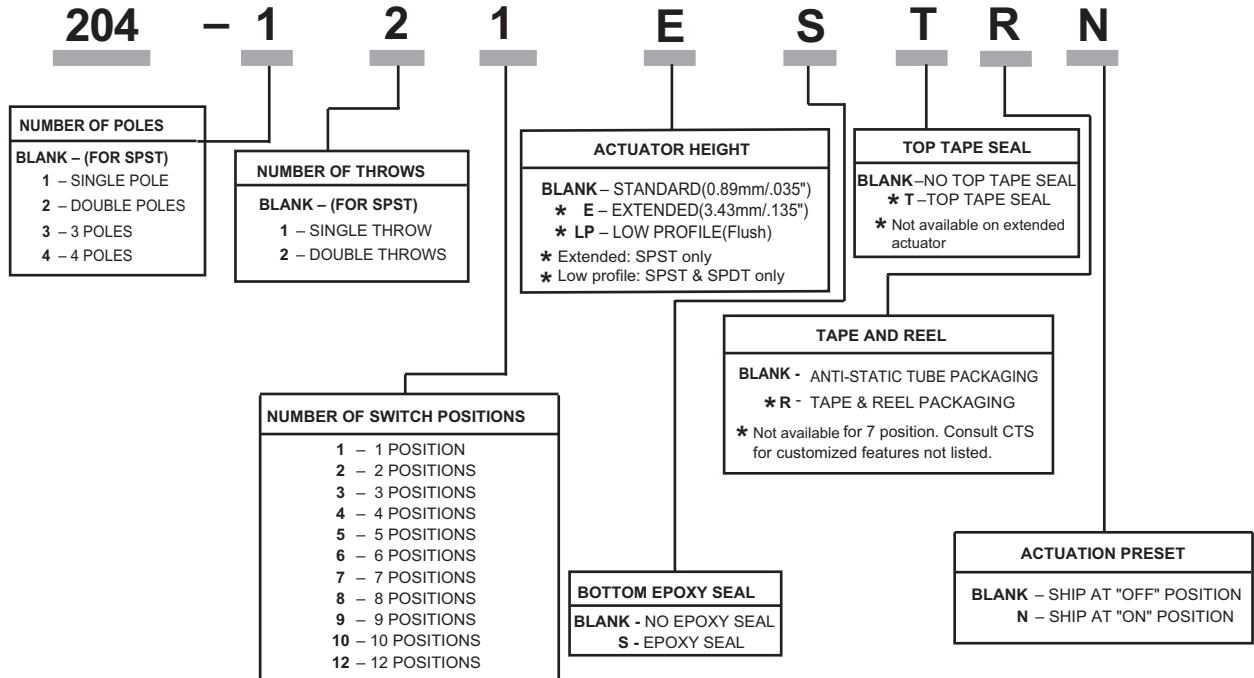

Contact CTS for other common features not listed.