

4

3

2

1

THIS DRAWING IS UNPUBLISHED. RELEASED FOR PUBLICATION 2010
 © COPYRIGHT 2010 BY TYCO ELECTRONICS CORPORATION. ALL RIGHTS RESERVED.

LOC	DIST	REVISIONS			
P	LTR	DESCRIPTION	DATE	DWN	APVD
E	B	BA	NEW RELEASE	05AUG2010	PT St.P

FOR FURTHER INFORMATION SEE DATA SHEET FOR
 SERIES SC - AXIAL LEADED POWER INDUCTORS

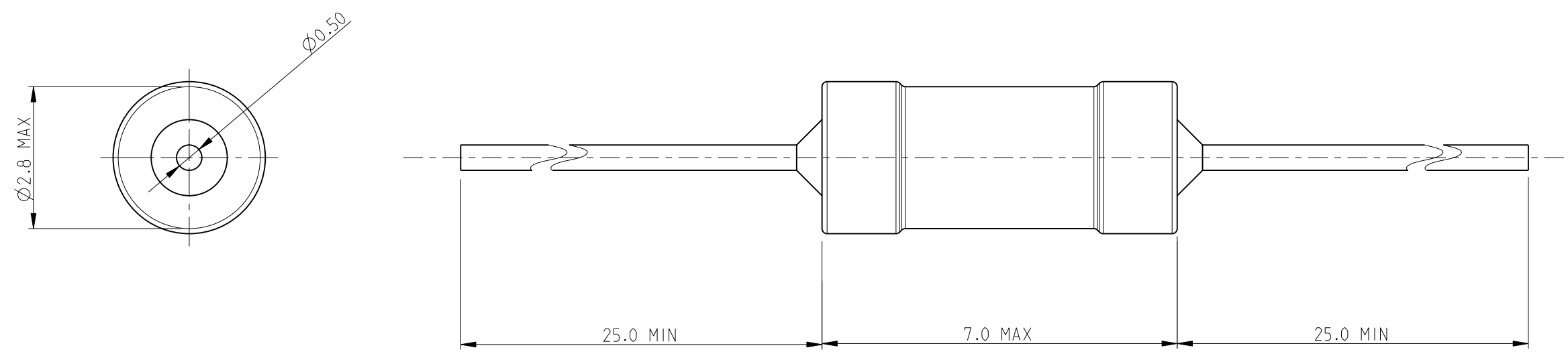

RoHS Compliant

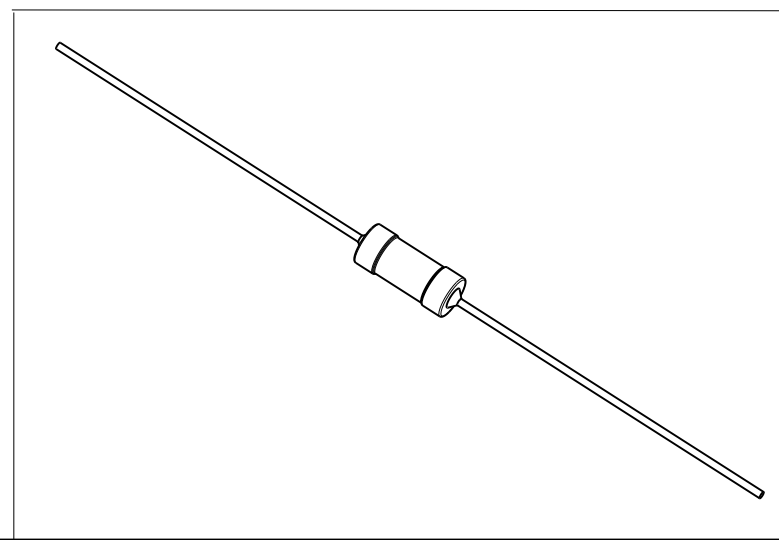

<small>THIS DRAWING IS A CONTROLLED DOCUMENT FOR TYCO ELECTRONICS CORPORATION IT IS SUBJECT TO CHANGE AND THE CONTROLLING ENGINEERING ORGANIZATION SHOULD BE CONTACTED FOR THE LATEST REVISION.</small>		DWN 05AUG2010 PARUSURAM.T		Tyco Electronics Corporation Dorcan, Swindon, SN3 5HH	
DIMENSIONS: mm		TOLERANCES UNLESS OTHERWISE SPECIFIED: 0 PLC ±0.2 1 PLC ±0.1 2 PLC ±- 3 PLC ±- 4 PLC ±- ANGLES ±5°		NAME AXIAL LEADED POWER INDUCTORS SERIES SC30	
MATERIAL -		FINISH -		SIZE A3 CAGE CODE 00779 DRAWING NO C-1624034 RESTRICTED TO -	
CUSTOMER DRAWING				SCALE 10:1 SHEET 1 OF 1 REV BA	