

DESCRIPTION: M12 FEMALE - CABLE MOUNT - SOLDER CUP - 12 POS.

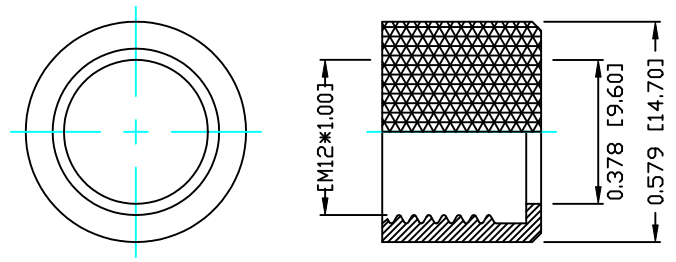

NUT

NOTE:

MATERIAL	
HOUSING:	PBT UL94V-0, BLACK
CONTACT:	BRASS
NUT:	BRASS
O-RING:	EPDM, BLACK
FINISH	
CONTACT:	GOLD PLATED OVER 50µ" NICKEL
NUT:	NICKEL PLATED
SHELL:	NICKEL PLATED
ELECTRICAL	
RATED CURRENT:	1A
RATED VOLTAGE:	30V
INSULATION RESISTANCE:	100 MΩhms MIN.
CONTACT RESISTANCE:	10 MΩhms MAX.
WATER PROOF:	IP67
ENVIRONMENT	
OPERATION TEMPERATURE:	-40°C TO +85°C
WIRE GAUGE:	24-28 AWG

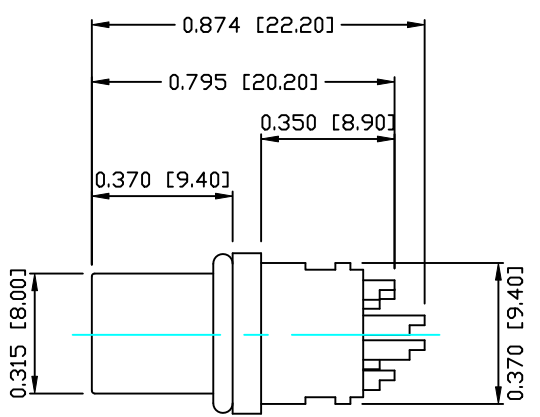
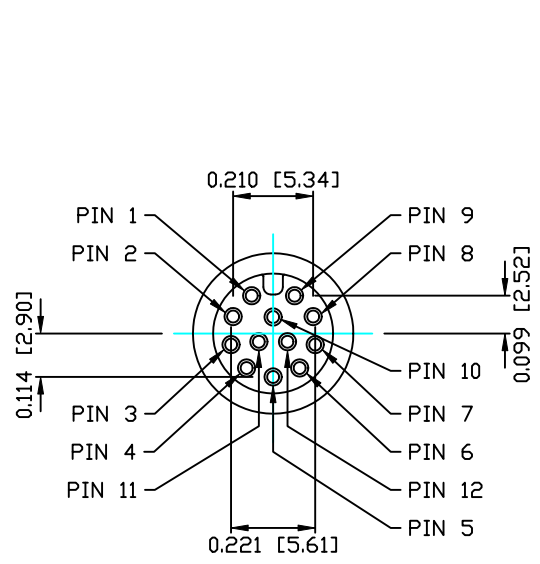

858-012-203RSUY

1 = GOLD FLASH
4 = 10µ" GOLD

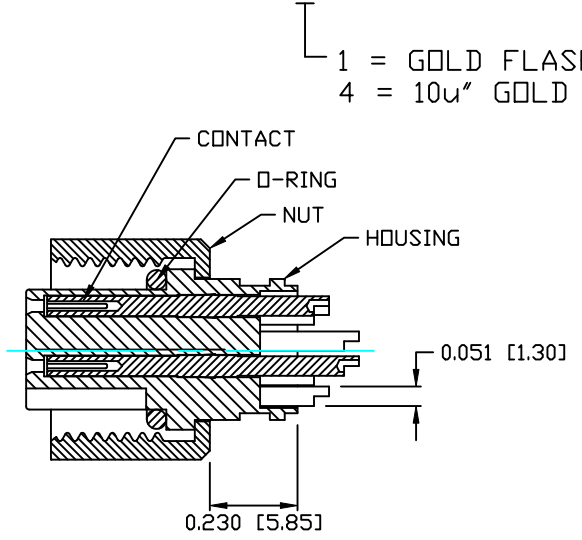

RoHS COMPLIANT

DO NOT SCALE FROM DRAWING



THESE DRAWINGS AND SPECIFICATIONS ARE THE PROPERTY OF NorComp AND SHALL NOT BE REPRODUCED, COPIED OR USED AS THE BASIS FOR THE MANUFACTURE OR SALE OF APPARATUS WITHOUT WRITTEN PERMISSION.

DRAWN:	M. SIGMON	DATE:	03-08-16
CHECKED:		DATE:	

NorComp

SCALE:	N.T.S.	SHEET	1	OF	1	REV	1
DWG NO.	858-012-203RSUY						