

Low Profile 0.3mm Pitch Connectors For FPC

FH18 Series

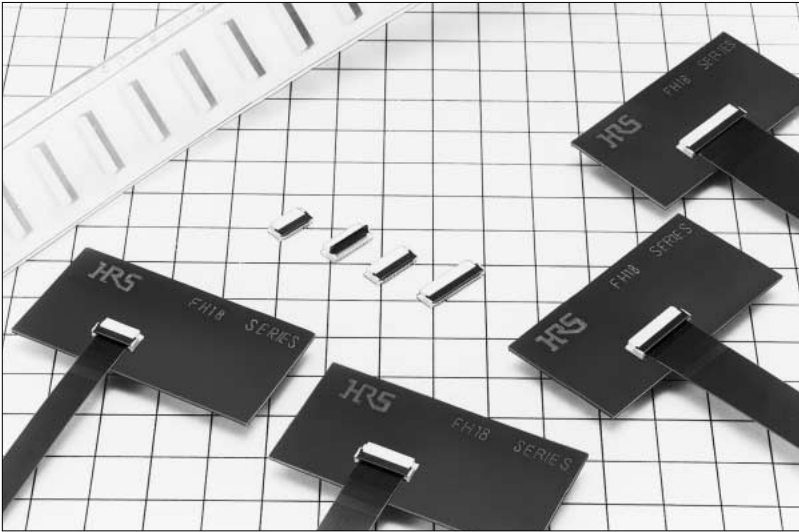

1.8mm height above the mounting surface

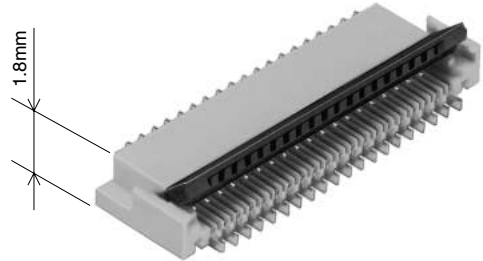

■ Features

1. Low profile 0.3mm pitch FPC connectors

In response to continuous miniturization of products, the demand for smaller contact spacing on connectors is increasing. Flexible printed circuits(FPC) with contact pitch of 0.3mm are used with increased frequency. FH18 series connectors fulfill this requirement. In addition, these connectors occupy less board space and are lighter than comparable connectors with contacts spaced at 0.5mm.

2. Improved Retention of FPC

Two types of contacts design are combined in the FH18 connector, zero insertion force(ZIF) and low insertion force(LIF). Inserted FPC is held in place by the LIF contact, allowing operator to close down the actuator and engage the ZIF contacts to assure complete connection.

3. Easy to use Flip-Lock

Flip-lock (rotating type) ZIF mechanism enables good connectivity of FPC by a simple operation and light force. No board space is required for flip lock operation as compared to slide lock ZIF connectors.

4. Placement on Board

The leads are on two sides of the connector, spaced on 0.6mm and are visible for solder joint inspection. Flat top surface of the connector allows board placement with automated equipment.

5. Variety of Contact Positions

The connectors are available with 17,21,25,27,39,45 and 51 contacts.

■ Applications

Notebook computers, printers, PDAs, digital cameras and other compact devices for interconnecting the main circuit board with the LCD, PDP (Plasma Display),HDD or other device.

LIF terminal contacts

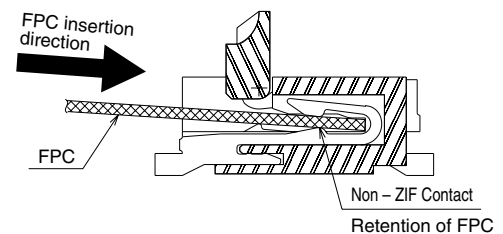

Connection completed

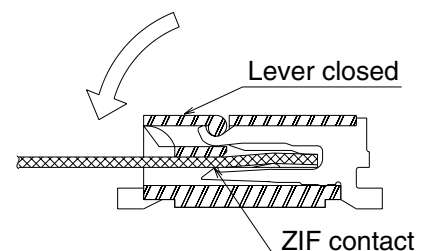

- * LIF : Low insertion Force
- * ZIF : Zero insertion Force

Product Specifications

Rating	Current rating 0.15A	Operating temperature range	-40°C to +85°C (Note 1)	Storage temperature range	-10°C to +50°C (Note 2)
	Voltage rating 30V AC	Operating humidity range	Relative humidity 90% max. (without condensation)	Storage humidity range	Relative humidity 90% max. (without condensation)

Applicable FPC	t=0.2±0.03 Solder plating (Note 4)
----------------	------------------------------------

Item	Specification	Conditions
1. Insulation resistance	50M ohms minimum	100V DC
2. Withstanding voltage	No flashover or insulation breakdown.	90V AC/1 minute
3. Contact resistance	100m ohms maximum	1mA
4. Durability (Insertion/withdrawal)	Contact resistance : 100m ohms maximum No damage, cracks, or parts dislocation.	10 cycles
5. Vibration	No electrical discontinuity of 1μs or more Contact resistance: 100m ohms maximum No damage, cracks, or parts dislocation.	Frequency: 10 to 55 Hz, single amplitude of 0.75 mm, 2 hours in each of the 3 directions.
6. Shock	No electrical discontinuity of 1μs or more Contact resistance: 100m ohms maximum No damage, cracks, or parts dislocation.	Acceleration of 490 m/s ² , 11 ms duration, sine half-wave waveform, 3 cycles in each of the 3 axis.
7. Humidity (Steady state)	Contact resistance: 100m ohms maximum Insulation resistance: 50M ohms maximum No damage, cracks, or parts dislocation.	96 hours at temperature of 40°C and humidity of 90% to 95%
8. Temperature cycle	Contact resistance: 100m ohms maximum. Insulation resistance: 50M ohms maximum. No damage, cracks, or parts dislocation.	5 cycles under conditions as follows; Temperature: -40°C → 15 to 35°C → 85°C → 15 to 35°C, Time: 30 → 5max. → 30 → 5 max.(minutes)
9. Resistance to soldering heat	No deformation of components affecting performance.	Reflow: At the recommended temperature profile Manual soldering: 350±5°C for 3 seconds

Note 1: Includes temperature rise caused by current flow.

Note 2: The term "storage" refers to products stored for long period of time prior to mounting and use. Operating Temperature Range and Humidity range covers nonconducting condition of installed connectors in storage, shipment or during transportation.

Material

Part	Material	Finish	Remarks
Insulator	LCP	Color : Beige	UL 94V-0
		Color : Black	
Contact	Phosphor bronze	Solder plating	——
Metal fitting	Bronze	Solder plating	——

Ordering Information

FH18 - 27S - 0.3 SHW (05)

① ② ③ ④ ⑤

① Series name	FH18
② Number of contacts	17, 21, 25, 27, 39, 45, 51
③ Contact pitch	0.3mm
④ Contact style	SHW : SMT horizontal mounting type
⑤ Plating specifications	No symbol : Solder plating (05) : Gold plating

◆ Connector Operating instruction

Operating Instruction

1. FPC (Flat Printed Circuit) Insertion

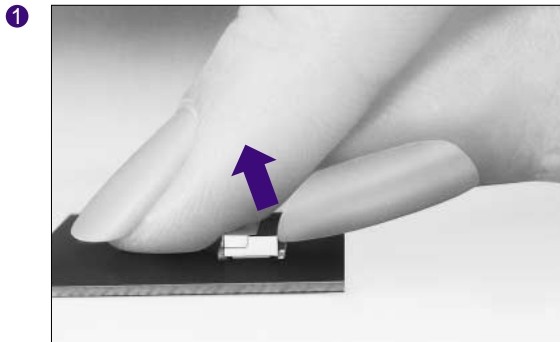

- A. Lift up carefully the lever to 90° max. angle.
Do not forcefully exceed the 90° angle, as this may cause damage to connector or the solder joints.

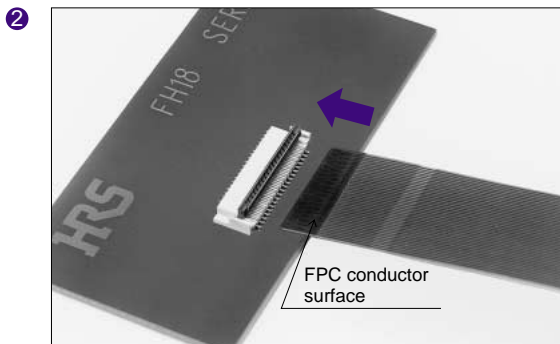

- B. Insert the FPC in the slot.
Assure that it is fully and straight inserted, with conductive surface facing down.
Slight friction of the LIF contacts will be felt and the FPC will remain inserted.

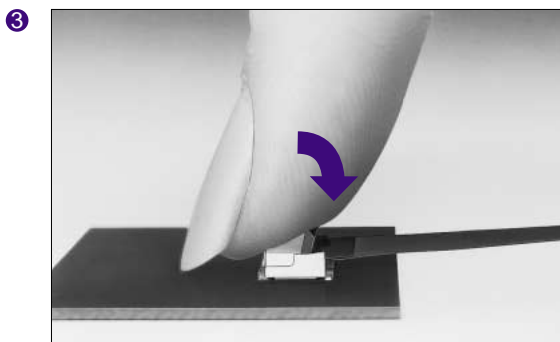

- C. Push the lever down to a fully closed position.

2. FPC removal

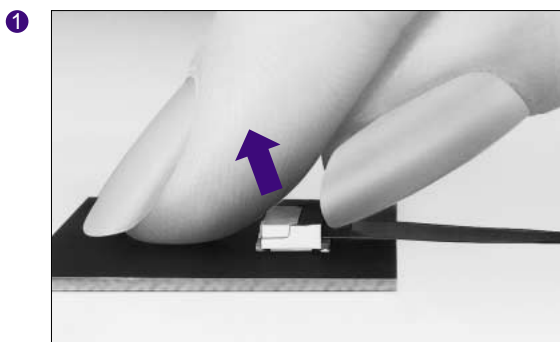

- A. Lift the lever up to a 90° angle.
B. Slide out the FPC until completely free.

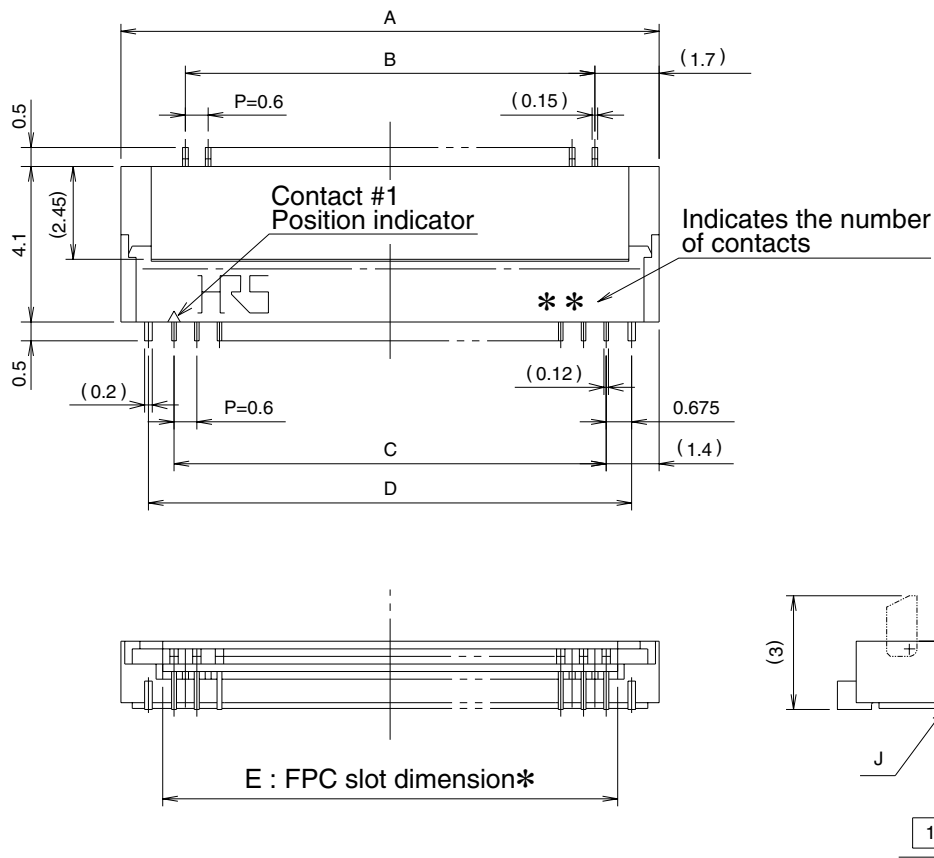

- Notes
- 1 Indicates the distance from J surface.
 - 2 The coplanarity of each lead and metal fitting within 0.1.(coplanarity : The distance between the lowest and highest land)
 - 3 This connector uses LIF(Low Insertion Force) and ZIF(Zero Insertion Force) contact design. Slight friction will be felt during insertion of FPC in the slot. Full insertion of FPC is required for secure connection.

Unit: mm

Part Number	CL No.	Number of contacts	A	B	C	D	E
FH18-17S-0.3SHW	586-0684-5	17	7.6	4.2	4.8	6.15	5.4
FH18-21S-0.3SHW	586-0669-1	21	8.8	5.4	6.0	7.35	6.6
FH18-25S-0.3SHW	586-0685-8	25	10.0	6.6	7.2	8.55	7.8
FH18-27S-0.3SHW	586-0658-5	27	10.6	7.2	7.8	9.15	8.4
FH18-39S-0.3SHW	586-0646-6	39	14.2	10.8	11.4	12.75	12.0
FH18-45S-0.3SHW	586-0694-9	45	16.0	12.6	13.2	14.55	13.8
FH18-51S-0.3SHW	586-0671-3	51	17.8	14.4	15.0	16.35	15.6

Note : Packaging will be embossed tape and reel (2,500 pcs/reel)
Please order by integral multiple of 2,500.

◆ Recommended Land/ Metal Mask Dimensions

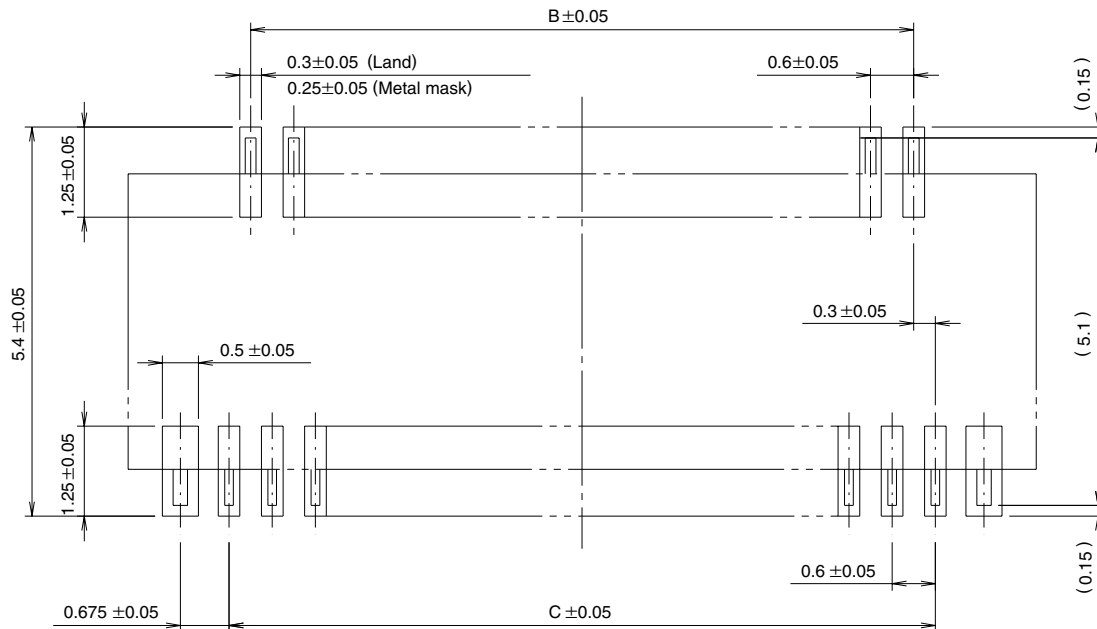

*Recommended metal mask thickness: $t=0.15$

◆ Recommended FPC Dimensions

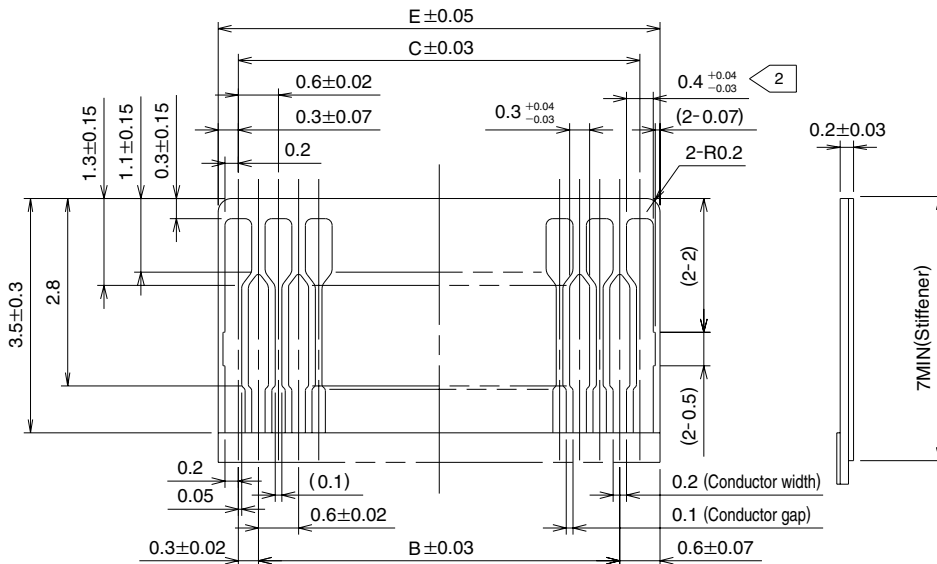

Note 1 Polyimide and thermal hardening glue are a recommendation for the stiffener.

② When drawing a plated lead, $0.3 \pm 0.04 - 0.03$ is also permitted.

Unit: mm

Part Number	CL No.	Number of contacts	B	C	E
FH18-17S-0.3SHW	586-0684-5	17	4.2	4.8	5.4
FH18-21S-0.3SHW	586-0669-1	21	5.4	6.0	6.6
FH18-25S-0.3SHW	586-0685-8	25	6.6	7.2	7.8
FH18-27S-0.3SHW	586-0658-5	27	7.2	7.8	8.4
FH18-39S-0.3SHW	586-0646-6	39	10.8	11.4	12.0
FH18-45S-0.3SHW	586-0694-9	45	12.6	13.2	13.8
FH18-51S-0.3SHW	586-0671-3	51	14.4	15.0	15.6

◆ Packaging Specifications

● Embossed Carrier Tape Dimensions

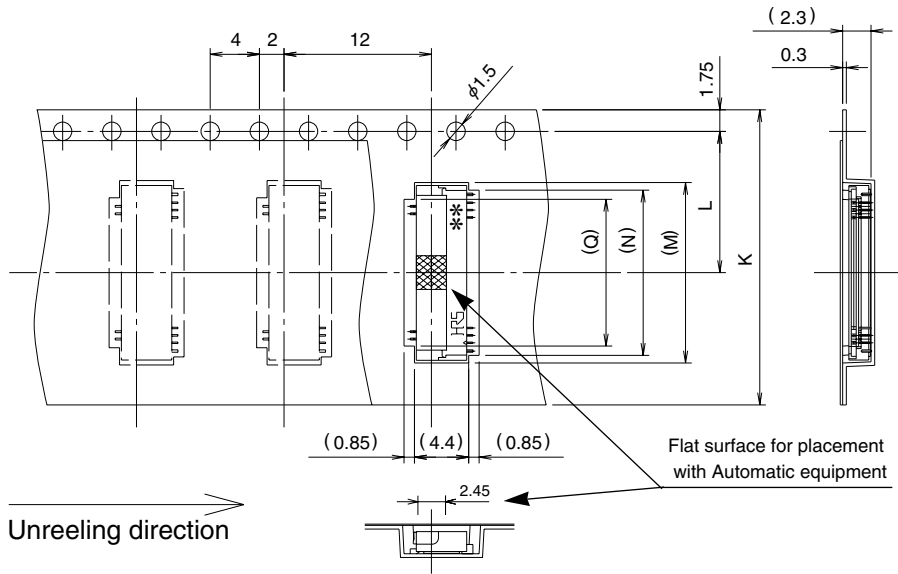

Unit: mm

Part Number	CL No.	Number of contacts	K	L	M	N	Q	R
FH18-17S-0.3SHW	586-0684-5	17	16	7.5	7.9	6.6	5.1	16.5
FH18-21S-0.3SHW	586-0669-1	21	16	7.5	9.1	7.8	6.3	16.5
FH18-25S-0.3SHW	586-0685-8	25	24	11.5	10.3	9.0	7.5	24.5
FH18-27S-0.3SHW	586-0658-5	27	24	11.5	10.9	9.6	8.1	24.5
FH18-39S-0.3SHW	586-0646-6	39	24	11.5	14.5	13.2	11.7	24.5
FH18-45S-0.3SHW	586-0694-9	45	24	11.5	16.3	15.0	13.5	24.5
FH18-51S-0.3SHW	586-0671-3	51	24	11.5	18.1	16.8	15.3	24.5

Note: One reel contains 2,500 connectors.

● Reel Dimensions

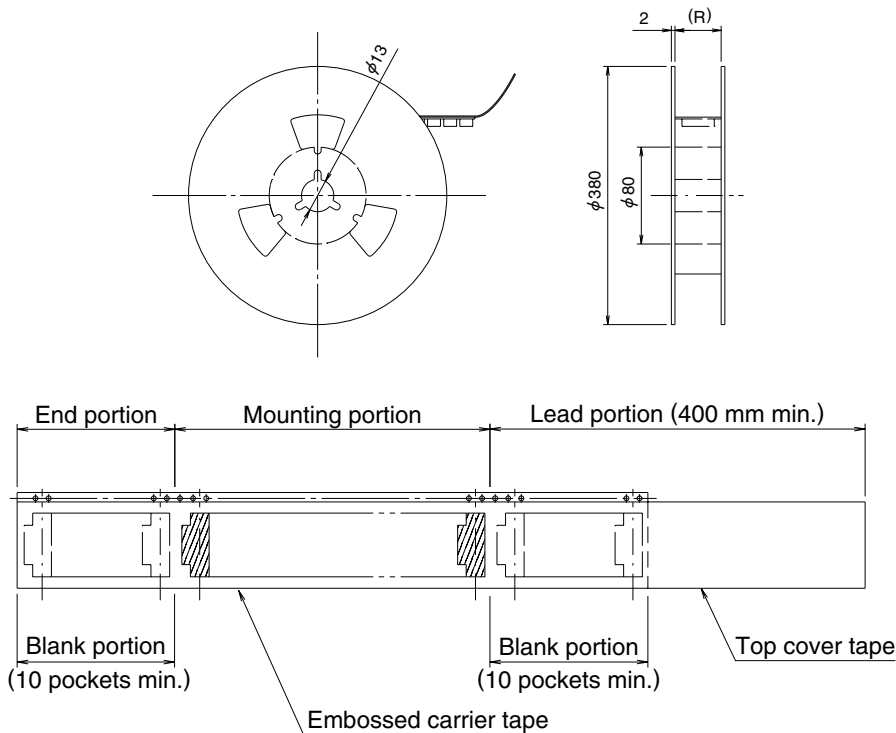

◆ Recommended Temperature Profile

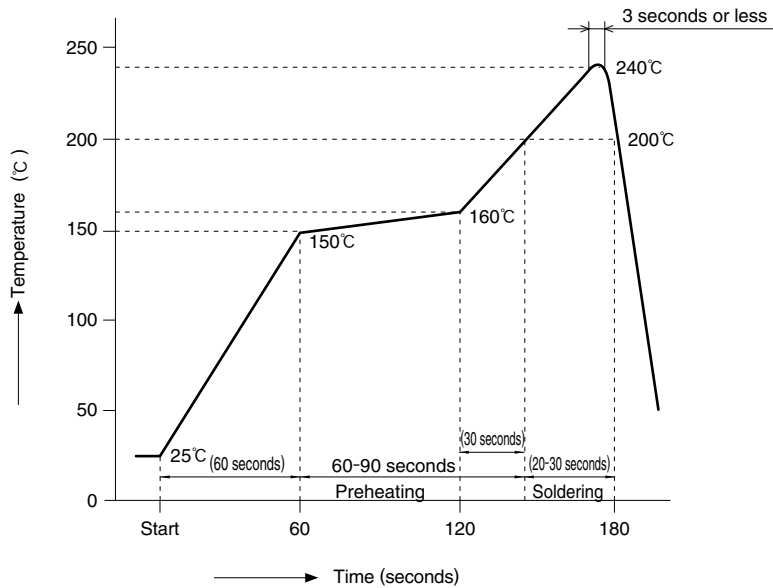

Applicable Conditions

Reflow method : IR reflow

Solder : Paste type 63Sn/37Pb
(Flux component of 11wt%)

Test board : Glass epoxy 70 x 70 x 1.6mm

Metal mask thickness : 0.15mm

Recommended temperature profile.

The temperature may be slightly changed according to the solder paste type and amount.

◆FH18 Series Construction (Recommended Specifications)

1. Single-Sided FPC

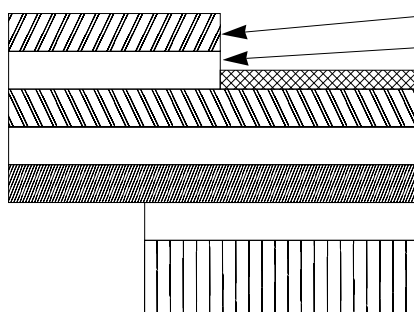

Material Name	Material	Thickness (μm)
Covering layer film	Polyamide 1 mil	25
Cover adhesive		25
Surface treatment	Solder plating	5
Copper foil	Cu 1oz	35
Base adhesive		25
Base film	Polyamide 1 mil	25
Reinforcement material adhesive		30
Stiffener	Polyamide 3 mil	75
Total		195

2. Using Double-Sided FPC

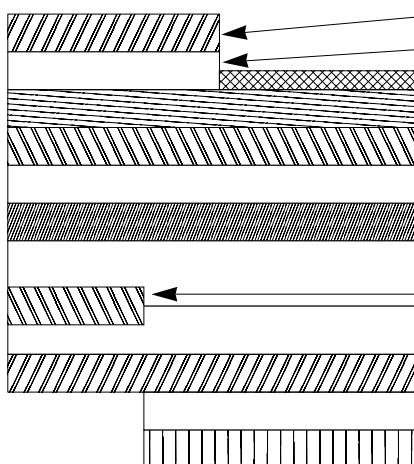

Material Name	Material	Thickness (μm)
Covering layer film	Polyamide 1 mil	25
Cover adhesive		25
Surface treatment	Solder plating	5
Through hole copper	Cu	15
Copper foil	Cu 1/2oz	18
Base adhesive		18
Base film	Polyamide 1 mil	25
Base adhesive		18
Copper foil	Cu 1/2oz	18
Cover adhesive		25
Cover layer film	Polyamide 1 mil	25
Reinforcement material adhesive		25
Stiffener	Polyamide 1 mil	25
Total		199

Note: Stiffener is not required for the double-sided FPC.

To prevent release of the lock due to FPC bending, please do not use copper foil on the rear side.

3. Precautions

1. This specification is a recommendation for the construction of the FH18 Series FPC ($t=0.2 \pm 0.03$).
2. For details about the construction, please contact the FPC/FFC manufacturers.

FPC/FFC Manufacturers' Contact List

Sumitomo Bakelite Co., Ltd. Flexible Printed Circuit Board Division
5-8, Higashi-shinagawa 2-chome, Shinagawa-ku, Tokyo, Japan

TEL:+81 3 5462 4191
FAX:+81 3 5462 4882

Fujikura Ltd. Electronics Global Marketing Department
1-5-1, Kiba, Koto-ku, Tokyo, Japan

TEL:+81 3 5606 1165
FAX:+81 3 5606 1530

NOK Corporation Sales Division Overseas Business Department
1-12-15, Shiba-Daimon, Minato-ku, Tokyo, Japan

TEL:+81 3 3432 6976/8415
FAX:+81 3 3432 3919