



# NPN SILICON RF TRANSISTOR NE664M04 / 2SC5754

## NPN SILICON RF TRANSISTOR FOR MEDIUM OUTPUT POWER AMPLIFICATION (0.4 W) FLAT-LEAD 4-PIN THIN-TYPE SUPER MINIMOLD

### FEATURES

- Ideal for 460 MHz to 2.4 GHz medium output power amplification
- $P_{O(1\text{ dB})} = 26.0\text{ dBm TYP. @ } V_{CE} = 3.6\text{ V, } f = 1.8\text{ GHz, } P_{in} = 15\text{ dBm}$
- High collector efficiency:  $\eta_C = 60\%$
- UHS0-HV technology ( $f_T = 25\text{ GHz}$ ) adopted
- High reliability through use of gold electrodes
- Flat-lead 4-pin thin-type super minimold package

### ORDERING INFORMATION

| Part Number                   | Quantity          | Supplying Form   |
|-------------------------------|-------------------|--|
| NE664M04-A<br>2SC5754-A       | 50 pcs (Non reel) | • 8 mm wide embossed taping  |
| NE664M04-T2-A<br>2SC5754-T2-A | 3 kpcs/reel       | • Pin 1 (Emitter), Pin 2 (Collector) face the perforation side of the tape |

**Remark** To order evaluation samples, contact your nearby sales office.  
The unit sample quantity is 50 pcs.

**Caution: Observe precautions when handling because these devices are sensitive to electrostatic discharge**

The information in this document is subject to change without notice. Before using this document, please confirm that this is the latest version.

**ABSOLUTE MAXIMUM RATINGS (T<sub>A</sub> = +25°C)**

| Parameter                    | Symbol                           | Ratings     | Unit |
|------------------------------|----------------------------------|-------------|------|
| Collector to Base Voltage    | V <sub>CBO</sub>                 | 13          | V    |
| Collector to Emitter Voltage | V <sub>CEO</sub>                 | 5.0         | V    |
| Emitter to Base Voltage      | V <sub>EBO</sub>                 | 1.5         | V    |
| Collector Current            | I <sub>c</sub>                   | 500         | mA   |
| Total Power Dissipation      | P <sub>tot</sub> <sup>Note</sup> | 735         | mW   |
| Junction Temperature         | T <sub>j</sub>                   | 150         | °C   |
| Storage Temperature          | T <sub>stg</sub>                 | -65 to +150 | °C   |

**Note** Mounted on 38 × 38 mm, t = 0.4 mm polyimide PCB

**THERMAL RESISTANCE**

| Parameter                      | Symbol               | Test Conditions                                 | Ratings | Unit |
|--------------------------------|----------------------|---|---------|------|
| Junction to Ambient Resistance | R <sub>th j-a1</sub> | Mounted on 38 × 38 mm, t = 0.4 mm polyimide PCB | 130     | °C/W |
|                                | R <sub>th j-a2</sub> | Stand alone device in free air                  | 570     | °C/W |

**ELECTRICAL CHARACTERISTICS (T<sub>A</sub> = +25°C)**

| Parameter                          | Symbol                            | Test Conditions  | MIN. | TYP. | MAX.  | Unit |
|------------------------------------|-----------------------------------|--|------|------|-------|------|
| DC Characteristics                 |                                   |  |      |      |       |      |
| Collector Cut-off Current          | I <sub>CB0</sub>                  | V <sub>CB</sub> = 5 V, I <sub>E</sub> = 0 mA   | –    | –    | 1 000 | nA   |
| Emitter Cut-off Current            | I <sub>EB0</sub>                  | V <sub>BE</sub> = 1 V, I <sub>C</sub> = 0 mA   | –    | –    | 1 000 | nA   |
| DC Current Gain                    | h <sub>FE</sub> <sup>Note 1</sup> | V <sub>CE</sub> = 3 V, I <sub>C</sub> = 100 mA   | 40   | 60   | 100   | –    |
| RF Characteristics                 |                                   |  |      |      |       |      |
| Gain Bandwidth Product             | f <sub>T</sub>                    | V <sub>CE</sub> = 3 V, I <sub>C</sub> = 100 mA, f = 0.5 GHz                                      | 16   | 20   | –     | GHz  |
| Insertion Power Gain               | S <sub>21e</sub>   <sup>2</sup>   | V <sub>CE</sub> = 3 V, I <sub>C</sub> = 100 mA, f = 2 GHz  | 5.0  | 6.5  | –     | dB   |
| Reverse Transfer Capacitance       | C <sub>re</sub> <sup>Note 2</sup> | V <sub>CB</sub> = 3 V, I <sub>E</sub> = 0 mA, f = 1 MHz  | –    | 1.0  | 1.5   | pF   |
| Maximum Available Power Gain       | MAG <sup>Note 3</sup>             | V <sub>CE</sub> = 3 V, I <sub>C</sub> = 100 mA, f = 2 GHz  | –    | 12.0 | –     | dB   |
| Linear Gain                        | G <sub>L</sub>                    | V <sub>CE</sub> = 3.6 V, I <sub>Cq</sub> = 20 mA, f = 1.8 GHz, P <sub>in</sub> = 0 dBm, 1/2 Duty | –    | 12.0 | –     | dB   |
| Gain 1 dB Compression Output Power | P <sub>O(1 dB)</sub>              | V <sub>CE</sub> = 3.6 V, I <sub>Cq</sub> = 4 mA, f = 1.8 GHz, P <sub>in</sub> = 15 dBm, 1/2 Duty | –    | 26.0 | –     | dBm  |
| Collector Efficiency               | η <sub>C</sub>                    | V <sub>CE</sub> = 3.6 V, I <sub>Cq</sub> = 4 mA, f = 1.8 GHz, P <sub>in</sub> = 15 dBm, 1/2 Duty | –    | 60   | –     | %    |

**Notes 1.** Pulse measurement: PW ≤ 350 μs, Duty Cycle ≤ 2%

**2.** Collector to base capacitance when the emitter grounded

$$3. \text{ MAG} = \left| \frac{S_{21}}{S_{12}} \right| (K - \sqrt{K^2 - 1})$$

**h<sub>FE</sub> CLASSIFICATION**

|                       |           |
|-----------------------|-----------|
| Rank                  | FB        |
| Marking               | R57       |
| h <sub>FE</sub> Value | 40 to 100 |

● TYPICAL CHARACTERISTICS (Unless otherwise specified,  $T_A = +25^\circ\text{C}$ )

TOTAL POWER DISSIPATION vs. AMBIENT TEMPERATURE

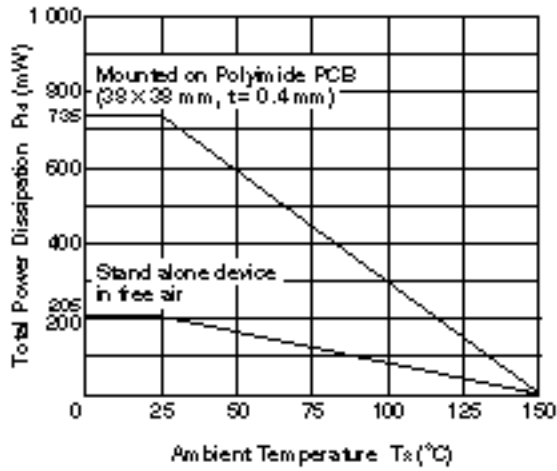

REVERSE TRANSFER CAPACITANCE vs. COLLECTOR TO BASE VOLTAGE

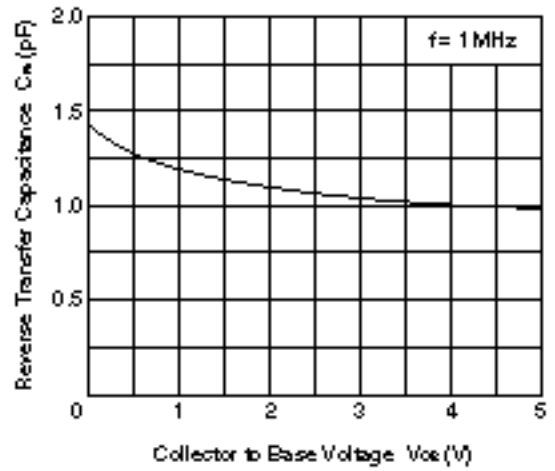

COLLECTOR CURRENT vs. BASE TO EMITTER VOLTAGE

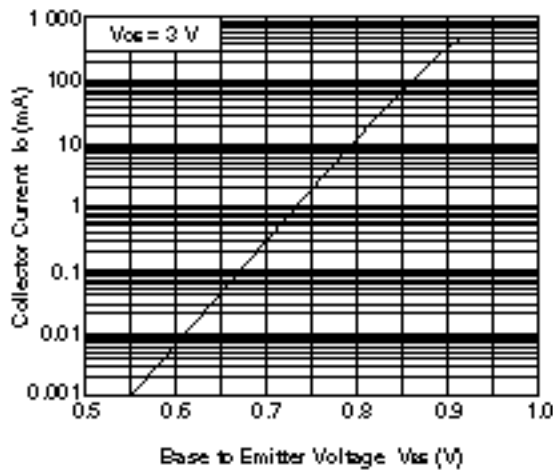

COLLECTOR CURRENT vs. COLLECTOR TO EMITTER VOLTAGE

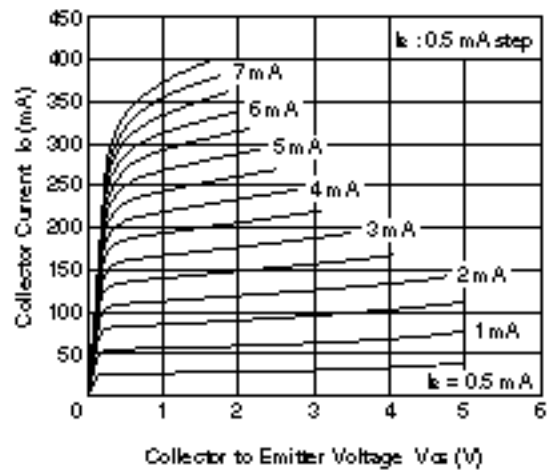

DC CURRENT GAIN vs. COLLECTOR CURRENT

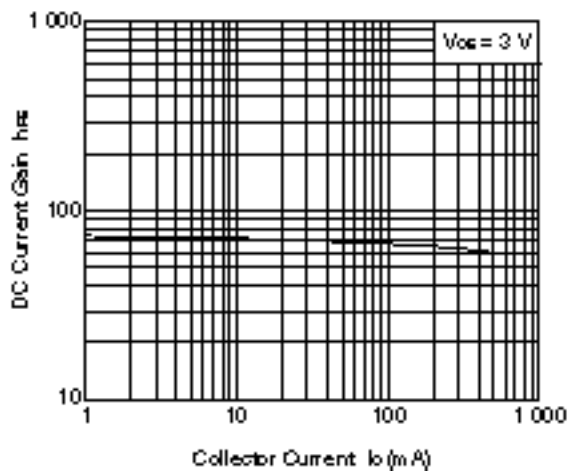

GAIN BANDWIDTH PRODUCT vs. COLLECTOR CURRENT

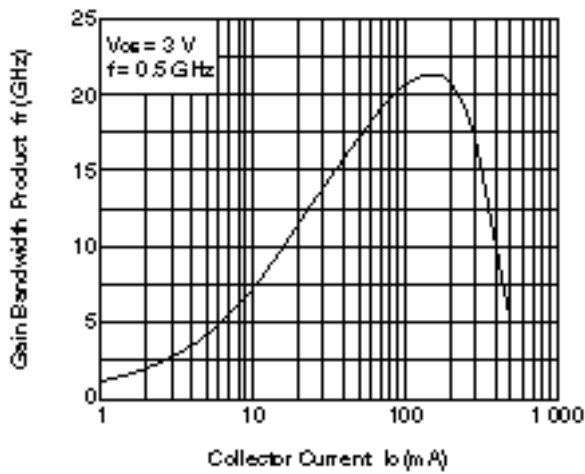

INSERTION POWER GAIN, MAG, MSG vs. FREQUENCY

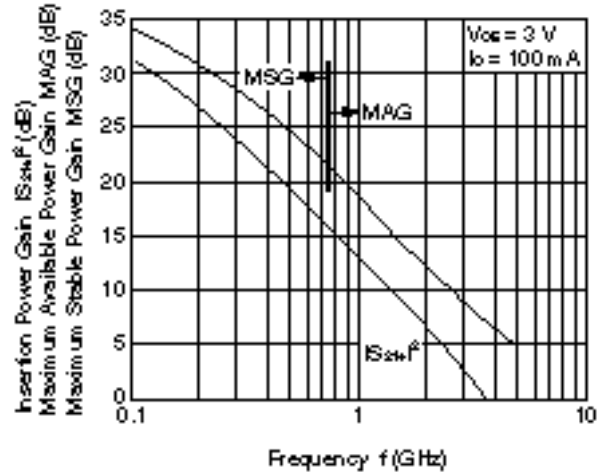

INSERTION POWER GAIN, MAG, MSG vs. COLLECTOR CURRENT

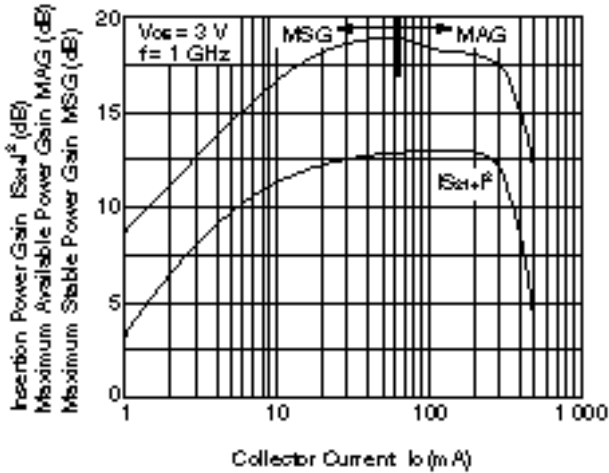

INSERTION POWER GAIN, MAG, MSG vs. COLLECTOR CURRENT

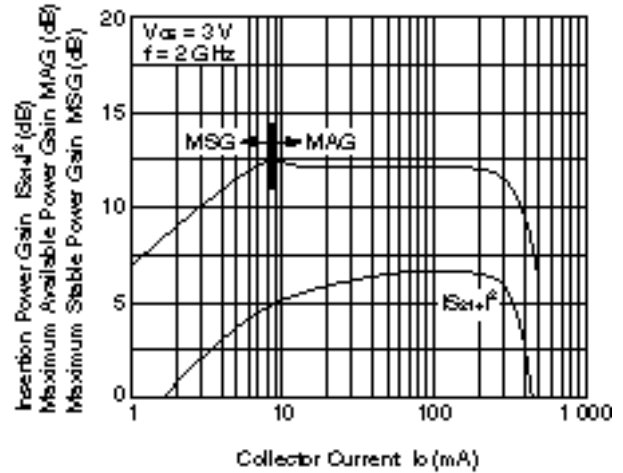

INSERTION POWER GAIN, MAG, MSG vs. COLLECTOR CURRENT

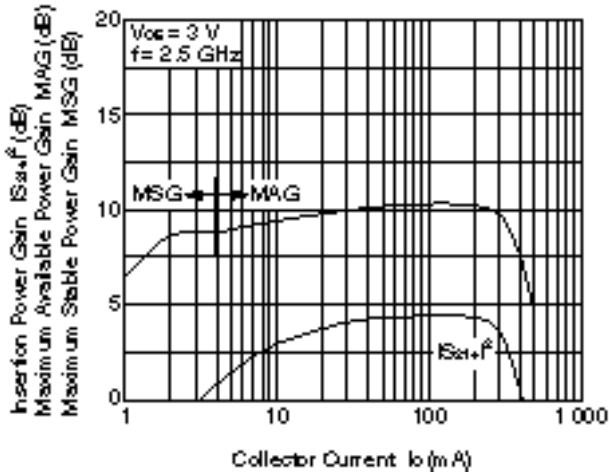

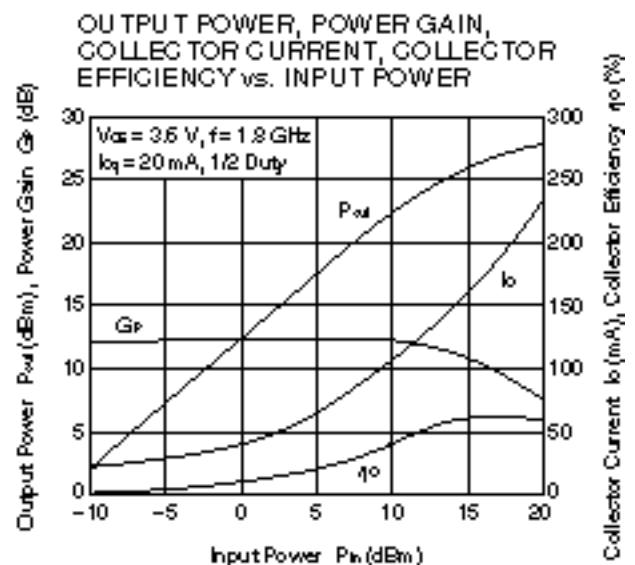
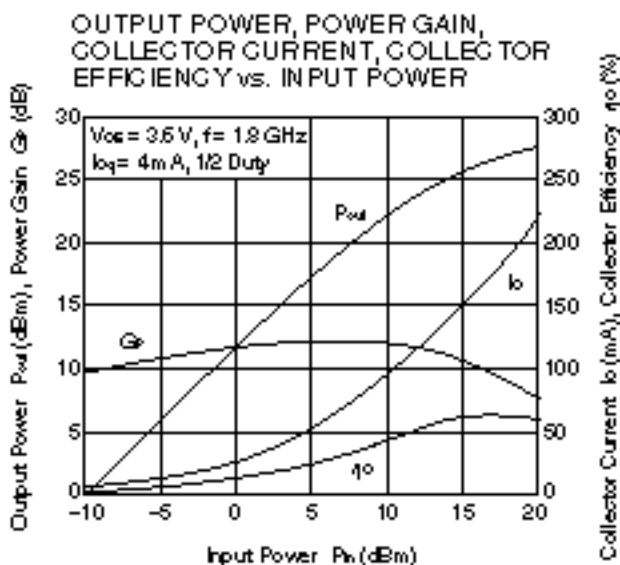
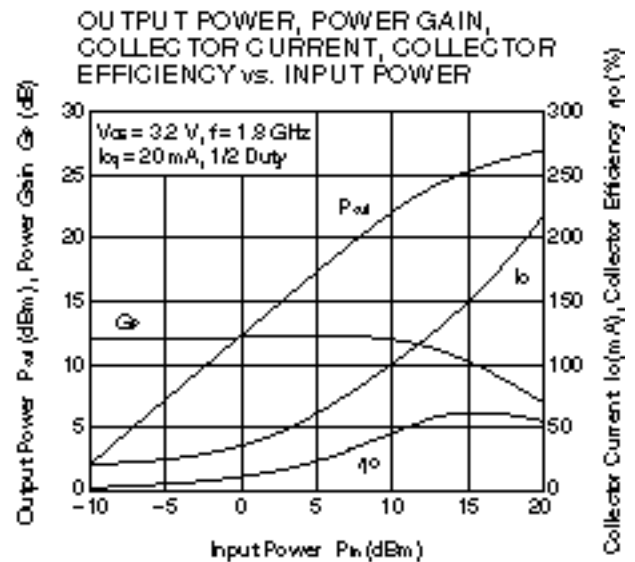
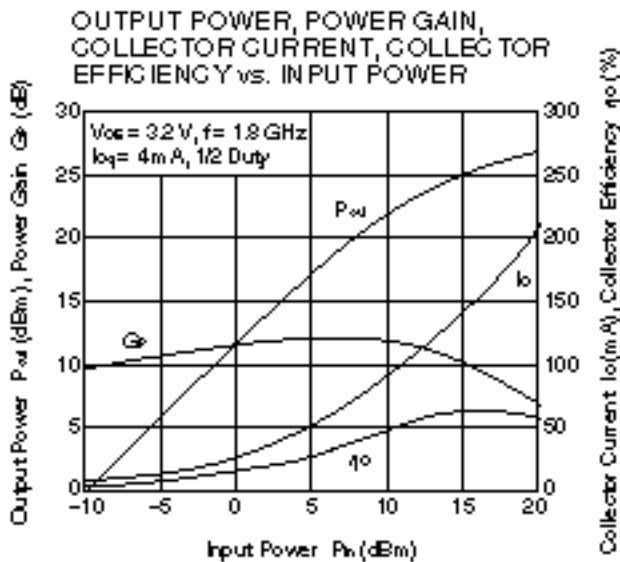
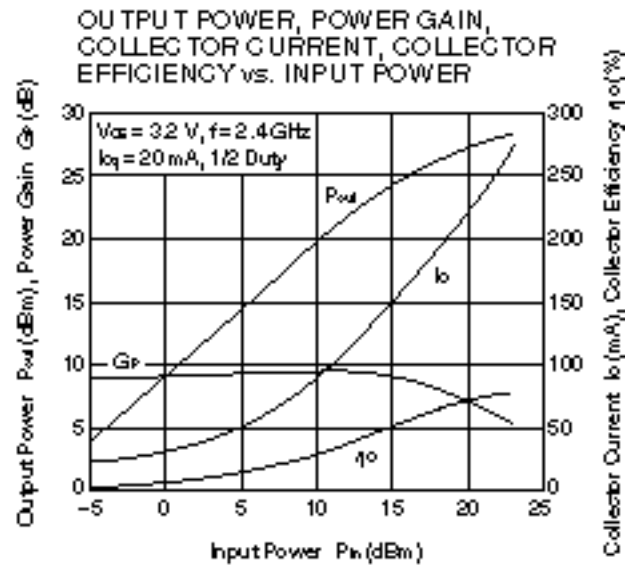
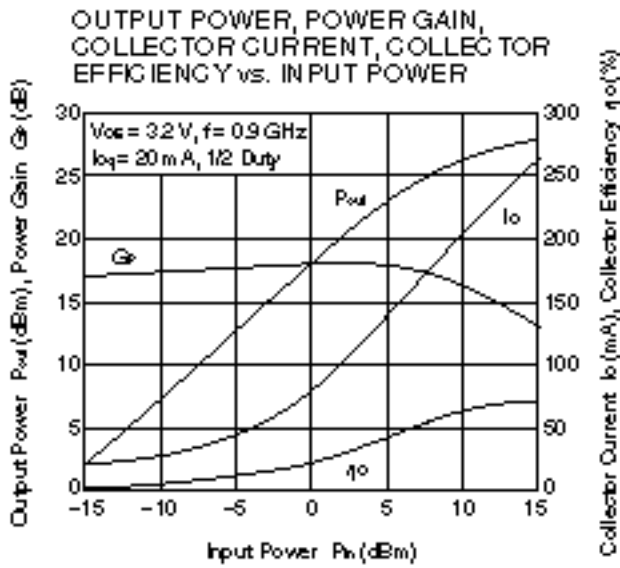

Remark The graphs indicate nominal characteristics.

**POWER SUPPLY IMPEDANCE, LOAD IMPEDANCE (Recommended value)**

| Frequency f (GHz) | Collector to Emitter Voltage $V_{CE}$ (V) | Supply Impedance $Z_s$ ( $\Omega$ ) | Load Impedance $Z_L$ ( $\Omega$ ) |
|-------------------|---|-------------------------------------|-----------------------------------|
| 0.9               | 2.8 to 3.6                                | 8.4 – 5.2 j                         | 15.1 – 4.3 j                      |
| 1.8               | 2.8 to 3.6                                | 6.3 – 16.4 j                        | 15.8 – 6.9 j                      |
| 2.4               | 2.8 to 3.6                                | 5.9 – 22.1 j                        | 15.2 – 17.9 j                     |

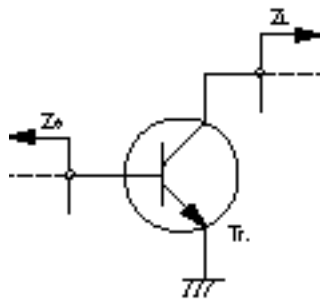

f = 0.9 GHz

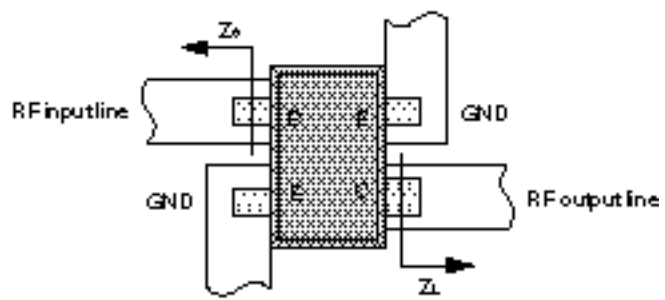
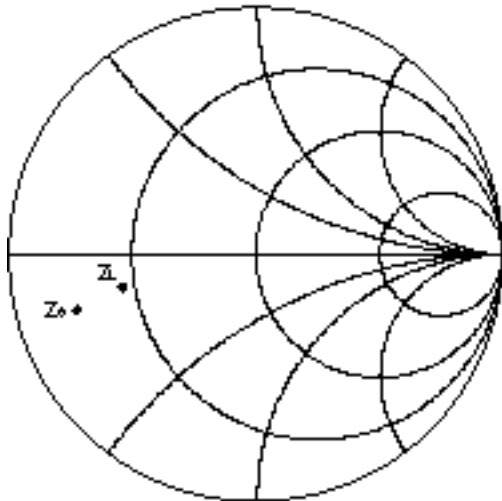

f = 1.8 GHz

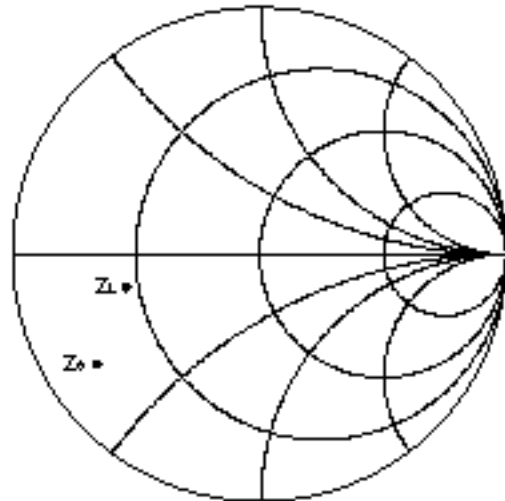

f = 2.4 GHz

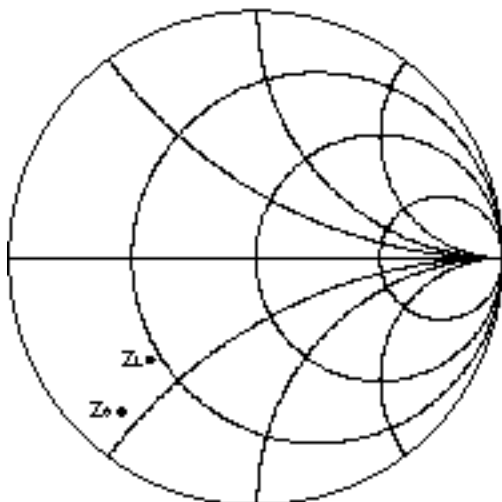

**APPLICATION EXAMPLE (Low-cost PA solution)**

Bluetooth Power Class 1  
f = 2.4 GHz

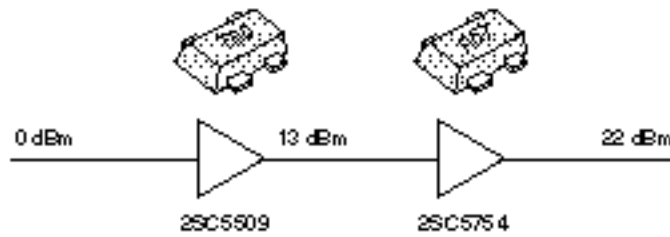

SS Cordless Phone  
f = 2.4 GHz

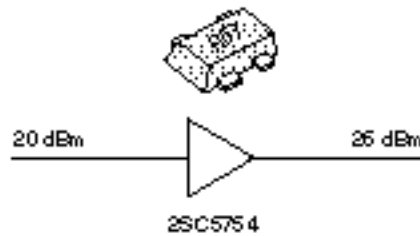

DCS1800 (GSM1800) Cellular Phone  
f = 1.8 GHz

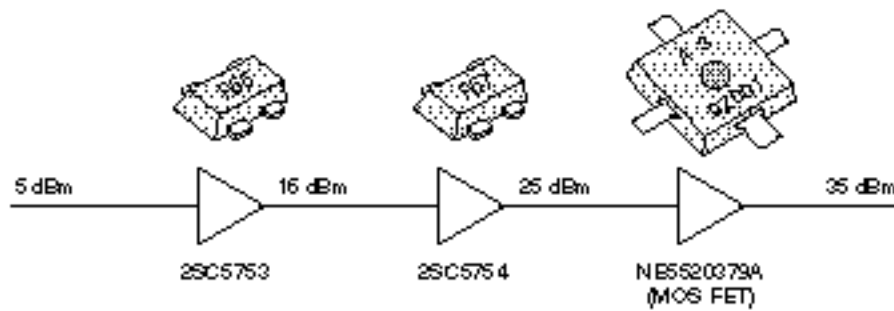

Cordless Phone  
f = 0.9 GHz

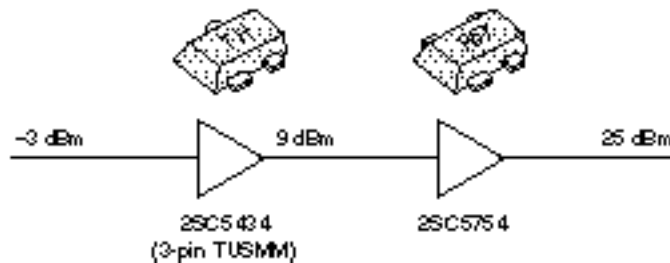



EVALUATION CIRCUIT EXAMPLE : 1.8 GHz PA EVALUATION BOARD

PCB Pattern and Element Layout

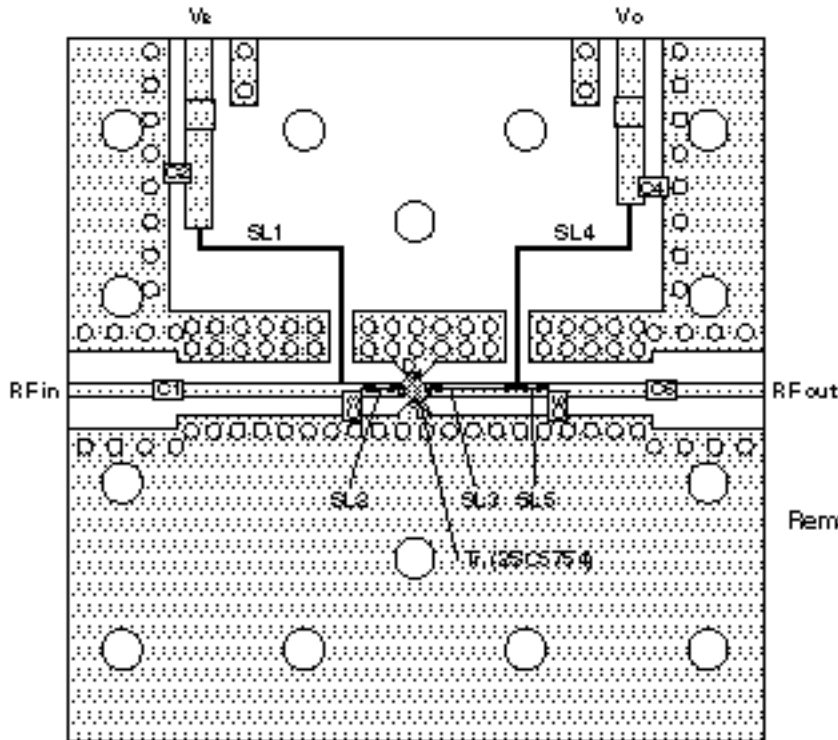

- Remarks
1. 38 × 38 mm, t=0.4 mm, ε= 4.55 double-sided copper-clad polyimide board
  2. Back side : GND pattern
  3. Solderplating on pattern
  4. ∅: Through holes

Equivalent Circuit

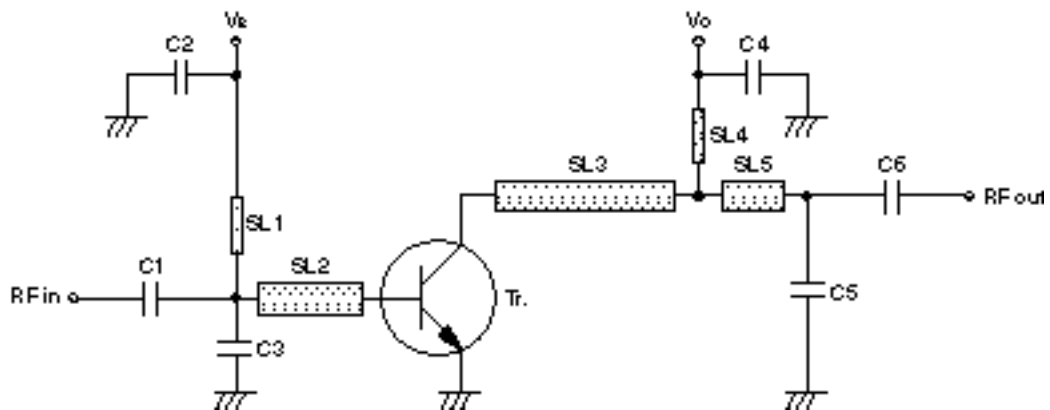

Parts List

| Parts    | Value    | Size                    | Classification                    |
|----------|----------|-------------------------|-----------------------------------|
| C1, C6   | 18 pF    |                         | Multilayer ceramic chip capacitor |
| C2       | 3 300 pF |                         | Multilayer ceramic chip capacitor |
| C3       | 3 pF     |                         | Multilayer ceramic chip capacitor |
| C4       | 15 pF    |                         | Multilayer ceramic chip capacitor |
| C5       | 1.5 pF   |                         | Multilayer ceramic chip capacitor |
| SL1, SL4 |          | w = 0.20 mm             | Strip line                        |
| SL2      |          | w = 0.76 mm, l = 2.5 mm | Strip line                        |
| SL3      |          | w = 0.76 mm, l = 5 mm   | Strip line                        |
| SL5      |          | w = 0.76 mm, l = 1.5 mm | Strip line                        |

EXAMPLE OF CHARACTERISTICS FOR 1.8 GHz PA EVALUATION BOARD

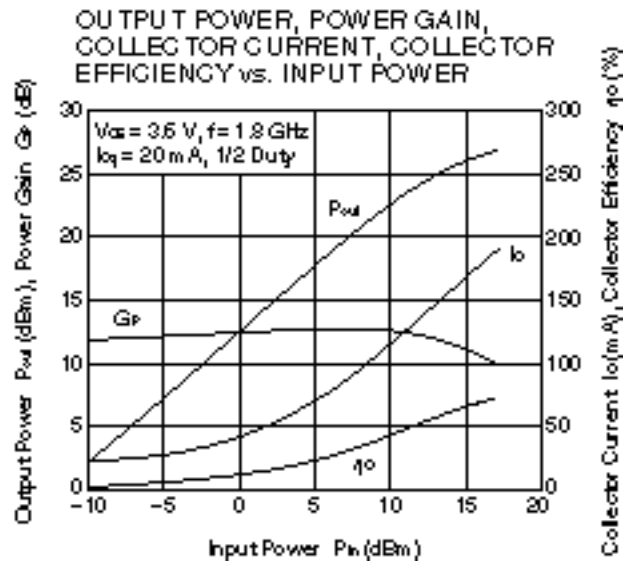
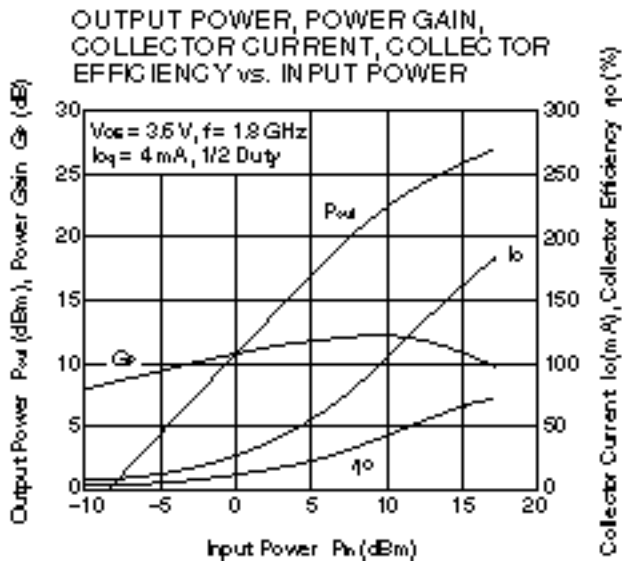
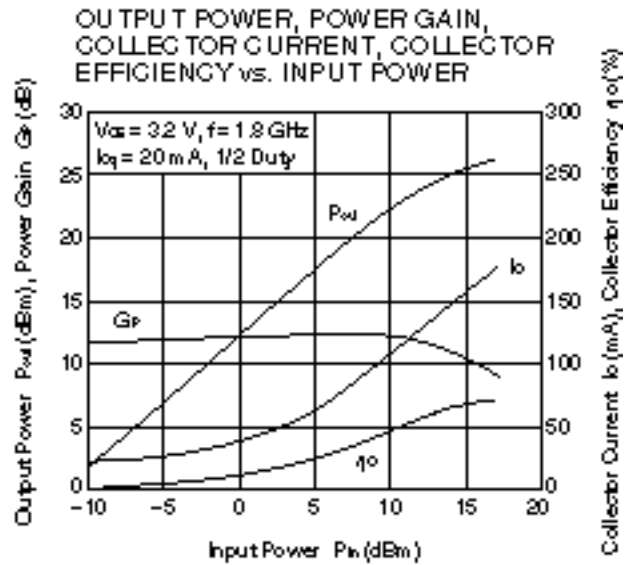
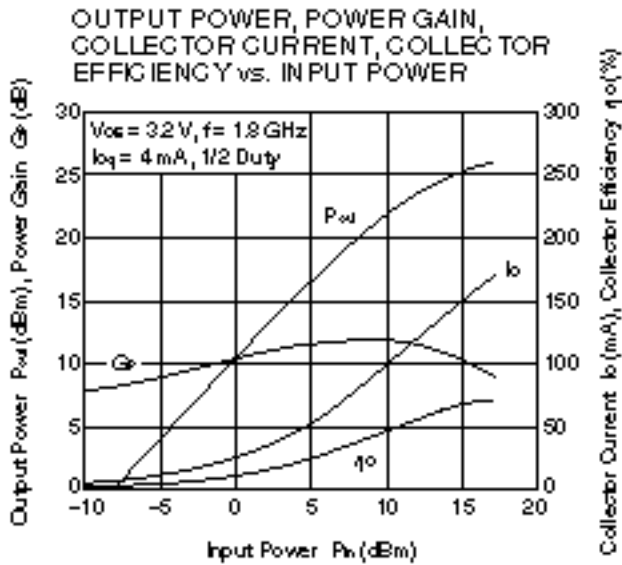

Remark The graphs indicate nominal characteristics.

**S-PARAMETERS**

**Note** When  $K \geq 1$ , the MAG (Maximum Available Power Gain) is used.  $MAG = \left| \frac{S_{21}}{S_{12}} \right| (K - \sqrt{K^2 - 1})$

When  $K < 1$ , the MSG (Maximum Stable Power Gain) is used.  $MSG = \left| \frac{S_{21}}{S_{12}} \right|$

$V_{CE} = 3 \text{ V}$ ,  $I_c = 4 \text{ mA}$ ,  $Z_o = 50 \Omega$

| Frequency<br>(GHz) | S <sub>11</sub> |                | S <sub>21</sub> |                | S <sub>12</sub> |                | S <sub>22</sub> |                | K     | MAG/MSG <sup>Note</sup><br>(dB) |
|--------------------|-----------------|----------------|-----------------|----------------|-----------------|----------------|-----------------|----------------|-------|---------------------------------|
|                    | MAG.            | ANG.<br>(deg.) | MAG.            | ANG.<br>(deg.) | MAG.            | ANG.<br>(deg.) | MAG.            | ANG.<br>(deg.) |       |                                 |
| 0.1                | 0.771           | -53.6          | 10.332          | 152.8          | 0.054           | 61.7           | 0.748           | -36.2          | 0.113 | 22.82                           |
| 0.2                | 0.777           | -90.9          | 10.223          | 129.7          | 0.093           | 42.6           | 0.721           | -52.4          | 0.176 | 20.41                           |
| 0.3                | 0.777           | -115.1         | 7.903           | 117.3          | 0.105           | 32.1           | 0.574           | -71.3          | 0.169 | 18.75                           |
| 0.4                | 0.787           | -131.9         | 6.419           | 107.5          | 0.113           | 23.9           | 0.477           | -84.5          | 0.198 | 17.55                           |
| 0.5                | 0.784           | -144.3         | 5.324           | 99.3           | 0.117           | 18.5           | 0.407           | -95.0          | 0.251 | 16.58                           |
| 0.6                | 0.790           | -153.9         | 4.575           | 92.5           | 0.119           | 14.4           | 0.364           | -104.1         | 0.284 | 15.84                           |
| 0.7                | 0.799           | -161.2         | 3.971           | 87.3           | 0.120           | 11.1           | 0.332           | -112.5         | 0.317 | 15.18                           |
| 0.8                | 0.803           | -167.5         | 3.507           | 82.2           | 0.121           | 8.3            | 0.311           | -119.3         | 0.353 | 14.62                           |
| 0.9                | 0.806           | -172.9         | 3.131           | 77.7           | 0.121           | 6.1            | 0.293           | -126.5         | 0.395 | 14.15                           |
| 1.0                | 0.808           | -177.5         | 2.835           | 73.7           | 0.120           | 4.4            | 0.281           | -132.1         | 0.438 | 13.72                           |
| 1.1                | 0.806           | 178.4          | 2.567           | 69.9           | 0.120           | 2.7            | 0.276           | -138.4         | 0.494 | 13.32                           |
| 1.2                | 0.809           | 174.9          | 2.359           | 66.2           | 0.119           | 1.5            | 0.270           | -143.6         | 0.535 | 12.98                           |
| 1.3                | 0.814           | 171.8          | 2.185           | 62.9           | 0.118           | 0.1            | 0.273           | -148.0         | 0.564 | 12.68                           |
| 1.4                | 0.817           | 168.4          | 2.030           | 59.7           | 0.117           | -1.0           | 0.272           | -152.7         | 0.602 | 12.38                           |
| 1.5                | 0.821           | 165.4          | 1.895           | 56.4           | 0.116           | -1.9           | 0.274           | -156.4         | 0.637 | 12.11                           |
| 1.6                | 0.819           | 162.5          | 1.776           | 53.3           | 0.115           | -2.9           | 0.277           | -161.1         | 0.698 | 11.87                           |
| 1.7                | 0.821           | 159.8          | 1.669           | 50.2           | 0.114           | -3.6           | 0.280           | -164.7         | 0.741 | 11.64                           |
| 1.8                | 0.826           | 156.9          | 1.577           | 46.9           | 0.113           | -4.2           | 0.289           | -168.8         | 0.767 | 11.44                           |
| 1.9                | 0.823           | 154.5          | 1.490           | 44.1           | 0.112           | -4.7           | 0.294           | -171.9         | 0.837 | 11.25                           |
| 2.0                | 0.830           | 151.3          | 1.415           | 40.9           | 0.111           | -5.2           | 0.303           | -174.9         | 0.849 | 11.04                           |
| 2.1                | 0.832           | 148.8          | 1.338           | 37.7           | 0.110           | -5.6           | 0.309           | -178.1         | 0.894 | 10.85                           |
| 2.2                | 0.837           | 146.2          | 1.280           | 35.0           | 0.109           | -5.6           | 0.317           | 178.9          | 0.923 | 10.71                           |
| 2.3                | 0.835           | 143.6          | 1.218           | 32.2           | 0.107           | -5.8           | 0.328           | 175.7          | 0.995 | 10.56                           |
| 2.4                | 0.836           | 141.2          | 1.160           | 29.5           | 0.106           | -5.8           | 0.338           | 173.2          | 1.046 | 9.07                            |
| 2.5                | 0.843           | 138.7          | 1.109           | 26.6           | 0.105           | -5.7           | 0.352           | 170.6          | 1.047 | 8.90                            |
| 2.6                | 0.845           | 136.5          | 1.052           | 24.1           | 0.105           | -5.8           | 0.360           | 169.0          | 1.092 | 8.16                            |
| 2.7                | 0.850           | 134.1          | 1.004           | 21.4           | 0.106           | -5.9           | 0.372           | 166.5          | 1.101 | 7.84                            |
| 2.8                | 0.852           | 132.2          | 0.960           | 19.0           | 0.105           | -6.0           | 0.379           | 164.4          | 1.144 | 7.32                            |
| 2.9                | 0.860           | 130.5          | 0.914           | 16.4           | 0.103           | -6.1           | 0.390           | 162.1          | 1.151 | 7.12                            |
| 3.0                | 0.863           | 128.8          | 0.879           | 14.1           | 0.101           | -6.0           | 0.398           | 159.9          | 1.188 | 6.75                            |
| 4.0                | 0.876           | 117.1          | 0.622           | -3.2           | 0.104           | 2.4            | 0.494           | 140.8          | 1.482 | 3.68                            |
| 5.0                | 0.902           | 102.8          | 0.461           | -20.4          | 0.117           | 0.2            | 0.624           | 125.0          | 1.296 | 2.69                            |

$V_{CE} = 3\text{ V}$ ,  $I_C = 10\text{ mA}$ ,  $Z_0 = 50\ \Omega$

| Frequency<br>(GHz) | S <sub>11</sub> |                | S <sub>21</sub> |                | S <sub>12</sub> |                | S <sub>22</sub> |                | K     | MAG/MSG<br>(dB) |
|--------------------|-----------------|----------------|-----------------|----------------|-----------------|----------------|-----------------|----------------|-------|-----------------|
|                    | MAG.            | ANG.<br>(deg.) | MAG.            | ANG.<br>(deg.) | MAG.            | ANG.<br>(deg.) | MAG.            | ANG.<br>(deg.) |       |                 |
| 0.1                | 0.658           | -82.1          | 19.246          | 142.9          | 0.041           | 51.9           | 0.692           | -60.8          | 0.161 | 26.72           |
| 0.2                | 0.708           | -127.0         | 15.736          | 118.5          | 0.061           | 35.9           | 0.584           | -89.6          | 0.246 | 24.10           |
| 0.3                | 0.750           | -145.1         | 11.390          | 107.0          | 0.065           | 27.9           | 0.509           | -113.3         | 0.270 | 22.41           |
| 0.4                | 0.769           | -156.9         | 8.892           | 99.2           | 0.068           | 23.4           | 0.463           | -129.5         | 0.335 | 21.14           |
| 0.5                | 0.777           | -165.2         | 7.166           | 93.0           | 0.070           | 21.4           | 0.435           | -141.6         | 0.409 | 20.11           |
| 0.6                | 0.782           | -171.8         | 6.060           | 87.6           | 0.072           | 20.4           | 0.425           | -150.7         | 0.473 | 19.26           |
| 0.7                | 0.796           | -176.7         | 5.232           | 83.5           | 0.074           | 19.8           | 0.419           | -158.3         | 0.518 | 18.51           |
| 0.8                | 0.800           | 179.2          | 4.586           | 79.4           | 0.075           | 19.5           | 0.414           | -164.2         | 0.570 | 17.85           |
| 0.9                | 0.801           | 175.2          | 4.078           | 75.8           | 0.076           | 19.5           | 0.414           | -169.9         | 0.634 | 17.29           |
| 1.0                | 0.805           | 171.9          | 3.676           | 72.6           | 0.078           | 19.5           | 0.412           | -174.5         | 0.680 | 16.74           |
| 1.1                | 0.805           | 168.8          | 3.326           | 69.6           | 0.079           | 19.6           | 0.418           | -178.8         | 0.738 | 16.23           |
| 1.2                | 0.810           | 166.0          | 3.044           | 66.4           | 0.081           | 19.7           | 0.419           | 177.2          | 0.773 | 15.75           |
| 1.3                | 0.811           | 163.6          | 2.817           | 63.5           | 0.083           | 19.9           | 0.424           | 174.3          | 0.810 | 15.31           |
| 1.4                | 0.814           | 161.0          | 2.611           | 60.8           | 0.085           | 20.0           | 0.427           | 170.9          | 0.846 | 14.89           |
| 1.5                | 0.818           | 158.4          | 2.431           | 58.2           | 0.087           | 20.0           | 0.429           | 168.2          | 0.875 | 14.49           |
| 1.6                | 0.816           | 156.0          | 2.276           | 55.6           | 0.088           | 19.7           | 0.436           | 164.9          | 0.919 | 14.11           |
| 1.7                | 0.819           | 153.6          | 2.134           | 52.8           | 0.090           | 19.7           | 0.440           | 162.3          | 0.948 | 13.74           |
| 1.8                | 0.822           | 151.1          | 2.014           | 50.0           | 0.092           | 19.6           | 0.449           | 159.7          | 0.968 | 13.40           |
| 1.9                | 0.821           | 149.1          | 1.900           | 47.7           | 0.094           | 19.4           | 0.453           | 157.3          | 1.001 | 12.81           |
| 2.0                | 0.829           | 146.3          | 1.798           | 44.7           | 0.096           | 19.2           | 0.459           | 155.2          | 1.004 | 12.32           |
| 2.1                | 0.832           | 144.0          | 1.697           | 42.2           | 0.098           | 18.9           | 0.464           | 152.9          | 1.029 | 11.35           |
| 2.2                | 0.836           | 141.7          | 1.622           | 39.5           | 0.100           | 18.7           | 0.470           | 150.8          | 1.034 | 10.98           |
| 2.3                | 0.833           | 139.3          | 1.549           | 37.2           | 0.102           | 18.4           | 0.480           | 148.6          | 1.073 | 10.19           |
| 2.4                | 0.836           | 137.1          | 1.473           | 35.1           | 0.103           | 17.8           | 0.487           | 146.8          | 1.091 | 9.72            |
| 2.5                | 0.842           | 134.7          | 1.404           | 32.6           | 0.105           | 17.3           | 0.497           | 145.0          | 1.088 | 9.45            |
| 2.6                | 0.844           | 132.8          | 1.332           | 30.5           | 0.107           | 16.7           | 0.499           | 143.5          | 1.104 | 8.99            |
| 2.7                | 0.847           | 130.5          | 1.267           | 28.0           | 0.109           | 16.0           | 0.509           | 141.8          | 1.112 | 8.61            |
| 2.8                | 0.852           | 128.8          | 1.211           | 26.1           | 0.110           | 15.5           | 0.514           | 140.1          | 1.121 | 8.29            |
| 2.9                | 0.858           | 127.3          | 1.155           | 23.7           | 0.111           | 15.0           | 0.522           | 138.6          | 1.119 | 8.09            |
| 3.0                | 0.862           | 125.9          | 1.111           | 21.8           | 0.111           | 14.6           | 0.525           | 136.7          | 1.128 | 7.82            |
| 4.0                | 0.870           | 115.0          | 0.801           | 6.2            | 0.128           | 12.2           | 0.579           | 121.3          | 1.236 | 5.04            |
| 5.0                | 0.894           | 101.2          | 0.609           | -10.4          | 0.141           | 3.3            | 0.660           | 110.5          | 1.161 | 3.92            |

$V_{CE} = 3\text{ V}$ ,  $I_C = 20\text{ mA}$ ,  $Z_O = 50\ \Omega$

| Frequency<br>(GHz) | S <sub>11</sub> |                | S <sub>21</sub> |                | S <sub>12</sub> |                | S <sub>22</sub> |                | K     | MAG/MSG<br>(dB) |
|--------------------|-----------------|----------------|-----------------|----------------|-----------------|----------------|-----------------|----------------|-------|-----------------|
|                    | MAG.            | ANG.<br>(deg.) | MAG.            | ANG.<br>(deg.) | MAG.            | ANG.<br>(deg.) | MAG.            | ANG.<br>(deg.) |       |                 |
| 0.1                | 0.617           | -113.5         | 26.805          | 134.3          | 0.029           | 48.5           | 0.657           | -83.2          | 0.235 | 29.60           |
| 0.2                | 0.715           | -149.3         | 18.809          | 111.7          | 0.041           | 34.8           | 0.573           | -117.3         | 0.351 | 26.64           |
| 0.3                | 0.763           | -161.5         | 13.211          | 101.4          | 0.043           | 30.7           | 0.544           | -137.8         | 0.410 | 24.87           |
| 0.4                | 0.777           | -169.8         | 10.147          | 94.9           | 0.046           | 30.0           | 0.530           | -151.1         | 0.508 | 23.45           |
| 0.5                | 0.786           | -175.7         | 8.126           | 89.7           | 0.048           | 30.9           | 0.519           | -160.5         | 0.603 | 22.30           |
| 0.6                | 0.788           | 179.5          | 6.815           | 85.0           | 0.051           | 32.0           | 0.519           | -167.4         | 0.678 | 21.28           |
| 0.7                | 0.797           | 175.7          | 5.858           | 81.6           | 0.054           | 32.8           | 0.520           | -173.2         | 0.735 | 20.37           |
| 0.8                | 0.804           | 172.4          | 5.119           | 77.9           | 0.057           | 33.6           | 0.519           | -177.7         | 0.779 | 19.55           |
| 0.9                | 0.804           | 169.2          | 4.548           | 74.8           | 0.059           | 34.5           | 0.523           | 178.0          | 0.834 | 18.84           |
| 1.0                | 0.809           | 166.7          | 4.094           | 72.0           | 0.063           | 35.2           | 0.522           | 174.3          | 0.868 | 18.16           |
| 1.1                | 0.807           | 164.2          | 3.703           | 69.3           | 0.066           | 35.4           | 0.530           | 170.9          | 0.909 | 17.50           |
| 1.2                | 0.813           | 161.8          | 3.386           | 66.4           | 0.069           | 35.6           | 0.532           | 167.6          | 0.930 | 16.91           |
| 1.3                | 0.815           | 159.6          | 3.132           | 63.7           | 0.073           | 35.7           | 0.536           | 165.0          | 0.946 | 16.34           |
| 1.4                | 0.817           | 157.3          | 2.898           | 61.4           | 0.076           | 35.5           | 0.539           | 162.2          | 0.970 | 15.82           |
| 1.5                | 0.821           | 155.1          | 2.696           | 58.9           | 0.079           | 35.3           | 0.541           | 159.6          | 0.984 | 15.32           |
| 1.6                | 0.818           | 152.9          | 2.522           | 56.5           | 0.083           | 34.6           | 0.547           | 157.0          | 1.008 | 14.29           |
| 1.7                | 0.822           | 150.6          | 2.362           | 54.0           | 0.086           | 34.4           | 0.550           | 154.6          | 1.022 | 13.49           |
| 1.8                | 0.827           | 148.6          | 2.226           | 51.4           | 0.089           | 33.5           | 0.559           | 152.3          | 1.021 | 13.10           |
| 1.9                | 0.823           | 146.4          | 2.104           | 49.2           | 0.092           | 33.0           | 0.561           | 150.2          | 1.046 | 12.26           |
| 2.0                | 0.834           | 143.9          | 1.988           | 46.5           | 0.095           | 32.3           | 0.567           | 148.1          | 1.035 | 12.05           |
| 2.1                | 0.834           | 141.5          | 1.872           | 44.0           | 0.099           | 31.5           | 0.571           | 146.0          | 1.051 | 11.41           |
| 2.2                | 0.837           | 139.5          | 1.787           | 41.7           | 0.101           | 30.7           | 0.575           | 144.1          | 1.057 | 11.02           |
| 2.3                | 0.836           | 137.2          | 1.706           | 39.6           | 0.104           | 29.9           | 0.585           | 142.0          | 1.071 | 10.52           |
| 2.4                | 0.840           | 135.2          | 1.621           | 37.6           | 0.106           | 28.9           | 0.589           | 140.4          | 1.077 | 10.16           |
| 2.5                | 0.844           | 133.0          | 1.546           | 35.3           | 0.109           | 27.6           | 0.600           | 138.6          | 1.076 | 9.84            |
| 2.6                | 0.848           | 131.1          | 1.464           | 33.4           | 0.112           | 26.7           | 0.601           | 137.3          | 1.079 | 9.46            |
| 2.7                | 0.852           | 129.0          | 1.397           | 31.1           | 0.114           | 25.6           | 0.609           | 135.6          | 1.078 | 9.17            |
| 2.8                | 0.855           | 127.2          | 1.333           | 29.3           | 0.115           | 24.7           | 0.612           | 134.0          | 1.087 | 8.82            |
| 2.9                | 0.863           | 125.8          | 1.271           | 27.2           | 0.117           | 24.1           | 0.618           | 132.6          | 1.081 | 8.63            |
| 3.0                | 0.865           | 124.3          | 1.222           | 25.2           | 0.118           | 23.4           | 0.622           | 130.8          | 1.088 | 8.34            |
| 4.0                | 0.871           | 114.0          | 0.884           | 10.9           | 0.139           | 16.7           | 0.661           | 115.4          | 1.147 | 5.71            |
| 5.0                | 0.896           | 100.5          | 0.677           | -4.5           | 0.152           | 5.8            | 0.717           | 105.1          | 1.103 | 4.54            |

V<sub>CE</sub> = 3 V, I<sub>C</sub> = 50 mA, Z<sub>O</sub> = 50 Ω

| Frequency<br>(GHz) | S <sub>11</sub> |                | S <sub>21</sub> |                | S <sub>12</sub> |                | S <sub>22</sub> |                | K     | MAG/MSG<br>(dB) |
|--------------------|-----------------|----------------|-----------------|----------------|-----------------|----------------|-----------------|----------------|-------|-----------------|
|                    | MAG.            | ANG.<br>(deg.) | MAG.            | ANG.<br>(deg.) | MAG.            | ANG.<br>(deg.) | MAG.            | ANG.<br>(deg.) |       |                 |
| 0.1                | 0.647           | -145.2         | 33.598          | 125.4          | 0.019           | 44.0           | 0.648           | -104.5         | 0.368 | 32.46           |
| 0.2                | 0.755           | -168.0         | 21.218          | 106.4          | 0.025           | 42.8           | 0.610           | -139.3         | 0.572 | 29.32           |
| 0.3                | 0.781           | -174.3         | 14.535          | 97.1           | 0.027           | 42.6           | 0.602           | -154.7         | 0.663 | 27.25           |
| 0.4                | 0.793           | -179.5         | 11.079          | 91.6           | 0.031           | 45.3           | 0.602           | -164.6         | 0.764 | 25.57           |
| 0.5                | 0.795           | 176.7          | 8.817           | 87.3           | 0.035           | 47.4           | 0.599           | -171.6         | 0.842 | 24.04           |
| 0.6                | 0.796           | 173.1          | 7.381           | 83.2           | 0.039           | 49.4           | 0.604           | -176.8         | 0.895 | 22.76           |
| 0.7                | 0.806           | 170.3          | 6.312           | 80.2           | 0.043           | 50.4           | 0.605           | 178.7          | 0.925 | 21.62           |
| 0.8                | 0.808           | 167.5          | 5.525           | 76.8           | 0.048           | 50.7           | 0.606           | 175.0          | 0.947 | 20.62           |
| 0.9                | 0.810           | 165.1          | 4.893           | 74.0           | 0.052           | 50.9           | 0.611           | 171.6          | 0.971 | 19.73           |
| 1.0                | 0.814           | 162.9          | 4.391           | 71.4           | 0.056           | 50.8           | 0.611           | 168.5          | 0.985 | 18.91           |
| 1.1                | 0.810           | 160.6          | 3.984           | 69.2           | 0.061           | 50.7           | 0.619           | 165.7          | 1.008 | 17.63           |
| 1.2                | 0.812           | 158.6          | 3.642           | 66.4           | 0.065           | 50.2           | 0.621           | 162.7          | 1.017 | 16.67           |
| 1.3                | 0.816           | 156.7          | 3.366           | 63.9           | 0.070           | 49.3           | 0.625           | 160.4          | 1.017 | 16.04           |
| 1.4                | 0.820           | 154.7          | 3.112           | 61.7           | 0.074           | 48.4           | 0.627           | 157.9          | 1.021 | 15.35           |
| 1.5                | 0.822           | 152.7          | 2.893           | 59.4           | 0.078           | 47.4           | 0.629           | 155.6          | 1.027 | 14.67           |
| 1.6                | 0.822           | 150.5          | 2.707           | 57.2           | 0.082           | 46.2           | 0.635           | 153.2          | 1.035 | 14.02           |
| 1.7                | 0.826           | 148.7          | 2.533           | 54.9           | 0.086           | 45.3           | 0.638           | 151.0          | 1.037 | 13.49           |
| 1.8                | 0.827           | 146.5          | 2.385           | 52.4           | 0.090           | 43.9           | 0.646           | 148.8          | 1.040 | 13.00           |
| 1.9                | 0.828           | 144.6          | 2.252           | 50.3           | 0.094           | 42.8           | 0.647           | 146.7          | 1.047 | 12.47           |
| 2.0                | 0.836           | 142.2          | 2.123           | 47.7           | 0.098           | 41.5           | 0.652           | 144.8          | 1.039 | 12.16           |
| 2.1                | 0.838           | 140.1          | 2.003           | 45.5           | 0.101           | 40.2           | 0.655           | 142.8          | 1.044 | 11.67           |
| 2.2                | 0.841           | 138.0          | 1.907           | 43.4           | 0.104           | 39.1           | 0.657           | 140.9          | 1.047 | 11.28           |
| 2.3                | 0.840           | 135.8          | 1.822           | 41.3           | 0.108           | 37.7           | 0.668           | 139.0          | 1.054 | 10.87           |
| 2.4                | 0.842           | 133.8          | 1.731           | 39.4           | 0.110           | 36.3           | 0.670           | 137.4          | 1.060 | 10.48           |
| 2.5                | 0.849           | 131.7          | 1.650           | 37.2           | 0.113           | 34.7           | 0.680           | 135.7          | 1.053 | 10.24           |
| 2.6                | 0.850           | 129.9          | 1.562           | 35.5           | 0.116           | 33.4           | 0.680           | 134.4          | 1.060 | 9.79            |
| 2.7                | 0.854           | 127.8          | 1.485           | 33.4           | 0.119           | 31.9           | 0.689           | 132.6          | 1.059 | 9.47            |
| 2.8                | 0.859           | 126.1          | 1.418           | 31.6           | 0.120           | 30.9           | 0.691           | 131.2          | 1.061 | 9.21            |
| 2.9                | 0.867           | 124.7          | 1.353           | 29.7           | 0.122           | 30.2           | 0.695           | 129.8          | 1.054 | 9.03            |
| 3.0                | 0.869           | 123.3          | 1.301           | 27.9           | 0.124           | 29.2           | 0.698           | 128.1          | 1.059 | 8.74            |
| 4.0                | 0.875           | 113.3          | 0.939           | 14.6           | 0.147           | 19.9           | 0.730           | 112.8          | 1.093 | 6.20            |
| 5.0                | 0.900           | 99.8           | 0.719           | -0.1           | 0.159           | 8.1            | 0.772           | 102.7          | 1.067 | 4.99            |

$V_{CE} = 3\text{ V}$ ,  $I_C = 100\text{ mA}$ ,  $Z_0 = 50\ \Omega$

| Frequency<br>(GHz) | S <sub>11</sub> |                | S <sub>21</sub> |                | S <sub>12</sub> |                | S <sub>22</sub> |                | K     | MAG/MSG<br>(dB) |
|--------------------|-----------------|----------------|-----------------|----------------|-----------------|----------------|-----------------|----------------|-------|-----------------|
|                    | MAG.            | ANG.<br>(deg.) | MAG.            | ANG.<br>(deg.) | MAG.            | ANG.<br>(deg.) | MAG.            | ANG.<br>(deg.) |       |                 |
| 0.1                | 0.693           | -161.1         | 36.699          | 121.5          | 0.014           | 58.0           | 0.629           | -118.6         | 0.633 | 34.23           |
| 0.2                | 0.777           | -174.9         | 22.046          | 104.6          | 0.018           | 50.1           | 0.633           | -147.6         | 0.722 | 30.88           |
| 0.3                | 0.790           | -179.4         | 15.005          | 95.4           | 0.023           | 53.9           | 0.624           | -160.6         | 0.820 | 28.23           |
| 0.4                | 0.801           | 176.7          | 11.384          | 90.5           | 0.027           | 55.4           | 0.629           | -169.1         | 0.885 | 26.32           |
| 0.5                | 0.801           | 173.7          | 9.034           | 86.5           | 0.031           | 57.8           | 0.629           | -175.3         | 0.942 | 24.61           |
| 0.6                | 0.800           | 170.4          | 7.543           | 82.5           | 0.036           | 58.8           | 0.633           | -179.9         | 0.973 | 23.18           |
| 0.7                | 0.811           | 168.2          | 6.460           | 79.6           | 0.041           | 59.0           | 0.636           | 176.1          | 0.980 | 21.95           |
| 0.8                | 0.813           | 165.9          | 5.645           | 76.5           | 0.046           | 58.6           | 0.635           | 172.7          | 0.992 | 20.89           |
| 0.9                | 0.813           | 163.7          | 5.006           | 73.7           | 0.051           | 58.2           | 0.642           | 169.6          | 1.004 | 19.53           |
| 1.0                | 0.817           | 161.6          | 4.499           | 71.3           | 0.056           | 57.7           | 0.642           | 166.6          | 1.011 | 18.44           |
| 1.1                | 0.813           | 159.5          | 4.066           | 68.9           | 0.060           | 56.8           | 0.650           | 164.0          | 1.025 | 17.32           |
| 1.2                | 0.816           | 157.4          | 3.718           | 66.4           | 0.065           | 55.7           | 0.651           | 161.2          | 1.029 | 16.55           |
| 1.3                | 0.820           | 155.7          | 3.437           | 63.8           | 0.070           | 54.5           | 0.655           | 159.0          | 1.026 | 15.95           |
| 1.4                | 0.822           | 153.6          | 3.175           | 61.8           | 0.074           | 53.2           | 0.658           | 156.5          | 1.030 | 15.24           |
| 1.5                | 0.826           | 151.8          | 2.954           | 59.5           | 0.079           | 51.9           | 0.659           | 154.3          | 1.031 | 14.68           |
| 1.6                | 0.825           | 149.6          | 2.763           | 57.3           | 0.083           | 50.3           | 0.666           | 151.9          | 1.035 | 14.08           |
| 1.7                | 0.829           | 147.9          | 2.581           | 55.0           | 0.087           | 49.4           | 0.667           | 149.8          | 1.037 | 13.54           |
| 1.8                | 0.830           | 145.9          | 2.436           | 52.6           | 0.091           | 47.6           | 0.674           | 147.7          | 1.038 | 13.09           |
| 1.9                | 0.830           | 144.0          | 2.292           | 50.7           | 0.095           | 46.4           | 0.676           | 145.7          | 1.044 | 12.54           |
| 2.0                | 0.838           | 141.7          | 2.164           | 48.1           | 0.099           | 44.8           | 0.679           | 143.8          | 1.038 | 12.21           |
| 2.1                | 0.842           | 139.5          | 2.038           | 45.9           | 0.103           | 43.3           | 0.683           | 141.8          | 1.039 | 11.77           |
| 2.2                | 0.843           | 137.5          | 1.944           | 43.8           | 0.106           | 42.0           | 0.685           | 140.0          | 1.041 | 11.40           |
| 2.3                | 0.842           | 135.3          | 1.854           | 41.8           | 0.109           | 40.4           | 0.695           | 138.2          | 1.048 | 10.97           |
| 2.4                | 0.845           | 133.2          | 1.762           | 40.0           | 0.112           | 38.9           | 0.698           | 136.5          | 1.050 | 10.62           |
| 2.5                | 0.851           | 131.3          | 1.675           | 37.8           | 0.115           | 37.2           | 0.706           | 134.9          | 1.045 | 10.35           |
| 2.6                | 0.854           | 129.4          | 1.589           | 36.1           | 0.118           | 35.7           | 0.706           | 133.6          | 1.047 | 9.97            |
| 2.7                | 0.856           | 127.4          | 1.512           | 34.1           | 0.121           | 34.1           | 0.715           | 131.9          | 1.049 | 9.62            |
| 2.8                | 0.863           | 125.7          | 1.442           | 32.3           | 0.122           | 33.2           | 0.716           | 130.4          | 1.049 | 9.37            |
| 2.9                | 0.868           | 124.4          | 1.376           | 30.5           | 0.124           | 32.3           | 0.721           | 129.0          | 1.048 | 9.13            |
| 3.0                | 0.873           | 122.9          | 1.324           | 28.7           | 0.125           | 31.2           | 0.724           | 127.3          | 1.046 | 8.93            |
| 4.0                | 0.874           | 113.0          | 0.954           | 15.7           | 0.149           | 21.2           | 0.754           | 112.1          | 1.081 | 6.33            |
| 5.0                | 0.898           | 99.6           | 0.731           | 1.5            | 0.161           | 9.1            | 0.793           | 102.0          | 1.063 | 5.03            |

$V_{CE} = 3\text{ V}$ ,  $I_C = 150\text{ mA}$ ,  $Z_O = 50\ \Omega$

| Frequency<br>(GHz) | S <sub>11</sub> |                | S <sub>21</sub> |                | S <sub>12</sub> |                | S <sub>22</sub> |                | K     | MAG/MSG<br>(dB) |
|--------------------|-----------------|----------------|-----------------|----------------|-----------------|----------------|-----------------|----------------|-------|-----------------|
|                    | MAG.            | ANG.<br>(deg.) | MAG.            | ANG.<br>(deg.) | MAG.            | ANG.<br>(deg.) | MAG.            | ANG.<br>(deg.) |       |                 |
| 0.1                | 0.716           | -163.4         | 36.859          | 120.7          | 0.012           | 52.3           | 0.632           | -121.0         | 0.611 | 34.91           |
| 0.2                | 0.788           | -176.8         | 22.148          | 104.0          | 0.017           | 57.2           | 0.632           | -150.7         | 0.801 | 31.13           |
| 0.3                | 0.799           | 179.3          | 15.025          | 95.0           | 0.021           | 58.1           | 0.627           | -162.8         | 0.869 | 28.54           |
| 0.4                | 0.802           | 175.7          | 11.366          | 90.1           | 0.026           | 60.6           | 0.634           | -170.8         | 0.933 | 26.48           |
| 0.5                | 0.803           | 172.5          | 9.013           | 86.0           | 0.031           | 61.8           | 0.634           | -176.6         | 0.971 | 24.67           |
| 0.6                | 0.804           | 169.7          | 7.533           | 82.1           | 0.036           | 62.4           | 0.639           | 179.0          | 0.993 | 23.24           |
| 0.7                | 0.812           | 167.5          | 6.447           | 79.2           | 0.041           | 62.0           | 0.641           | 175.2          | 0.997 | 21.98           |
| 0.8                | 0.814           | 165.2          | 5.627           | 76.2           | 0.046           | 61.1           | 0.641           | 171.9          | 1.006 | 20.43           |
| 0.9                | 0.815           | 163.0          | 4.984           | 73.4           | 0.050           | 60.8           | 0.647           | 168.8          | 1.017 | 19.15           |
| 1.0                | 0.817           | 161.1          | 4.482           | 71.1           | 0.055           | 59.8           | 0.648           | 165.9          | 1.022 | 18.18           |
| 1.1                | 0.816           | 159.1          | 4.055           | 68.8           | 0.060           | 58.7           | 0.656           | 163.4          | 1.029 | 17.24           |
| 1.2                | 0.822           | 157.1          | 3.706           | 66.2           | 0.065           | 57.7           | 0.657           | 160.8          | 1.029 | 16.54           |
| 1.3                | 0.820           | 155.4          | 3.427           | 63.7           | 0.070           | 56.4           | 0.661           | 158.5          | 1.033 | 15.81           |
| 1.4                | 0.824           | 153.4          | 3.163           | 61.6           | 0.074           | 54.9           | 0.664           | 156.0          | 1.032 | 15.19           |
| 1.5                | 0.826           | 151.4          | 2.938           | 59.5           | 0.079           | 53.4           | 0.665           | 153.9          | 1.036 | 14.57           |
| 1.6                | 0.826           | 149.4          | 2.752           | 57.3           | 0.083           | 51.9           | 0.672           | 151.5          | 1.039 | 14.00           |
| 1.7                | 0.829           | 147.6          | 2.573           | 55.0           | 0.087           | 50.7           | 0.673           | 149.4          | 1.041 | 13.47           |
| 1.8                | 0.832           | 145.7          | 2.423           | 52.6           | 0.091           | 48.8           | 0.681           | 147.2          | 1.040 | 13.03           |
| 1.9                | 0.830           | 143.8          | 2.287           | 50.6           | 0.095           | 47.5           | 0.681           | 145.3          | 1.046 | 12.49           |
| 2.0                | 0.839           | 141.2          | 2.154           | 48.1           | 0.099           | 45.9           | 0.685           | 143.4          | 1.040 | 12.15           |
| 2.1                | 0.841           | 139.1          | 2.028           | 45.9           | 0.102           | 44.5           | 0.688           | 141.5          | 1.044 | 11.68           |
| 2.2                | 0.844           | 137.3          | 1.934           | 43.8           | 0.106           | 43.0           | 0.690           | 139.7          | 1.043 | 11.33           |
| 2.3                | 0.842           | 135.1          | 1.848           | 41.9           | 0.109           | 41.4           | 0.700           | 137.9          | 1.049 | 10.92           |
| 2.4                | 0.847           | 132.9          | 1.755           | 40.1           | 0.112           | 39.7           | 0.703           | 136.2          | 1.050 | 10.59           |
| 2.5                | 0.853           | 131.0          | 1.672           | 37.9           | 0.115           | 38.0           | 0.712           | 134.6          | 1.044 | 10.34           |
| 2.6                | 0.856           | 129.2          | 1.581           | 36.3           | 0.118           | 36.5           | 0.712           | 133.3          | 1.048 | 9.94            |
| 2.7                | 0.860           | 127.2          | 1.505           | 34.2           | 0.121           | 35.0           | 0.719           | 131.6          | 1.047 | 9.64            |
| 2.8                | 0.865           | 125.6          | 1.435           | 32.5           | 0.122           | 34.0           | 0.722           | 130.2          | 1.048 | 9.35            |
| 2.9                | 0.871           | 124.1          | 1.371           | 30.6           | 0.124           | 33.1           | 0.727           | 128.7          | 1.044 | 9.15            |
| 3.0                | 0.874           | 122.8          | 1.318           | 28.7           | 0.126           | 32.0           | 0.730           | 127.0          | 1.045 | 8.90            |
| 4.0                | 0.879           | 113.0          | 0.951           | 15.8           | 0.149           | 21.8           | 0.758           | 112.0          | 1.073 | 6.39            |
| 5.0                | 0.900           | 99.8           | 0.727           | 1.7            | 0.162           | 9.5            | 0.797           | 101.9          | 1.060 | 5.04            |



$V_{CE} = 3\text{ V}$ ,  $I_C = 200\text{ mA}$ ,  $Z_0 = 50\ \Omega$

| Frequency<br>(GHz) | S <sub>11</sub> |                | S <sub>21</sub> |                | S <sub>12</sub> |                | S <sub>22</sub> |                | K     | MAG/MSG<br>(dB) |
|--------------------|-----------------|----------------|-----------------|----------------|-----------------|----------------|-----------------|----------------|-------|-----------------|
|                    | MAG.            | ANG.<br>(deg.) | MAG.            | ANG.<br>(deg.) | MAG.            | ANG.<br>(deg.) | MAG.            | ANG.<br>(deg.) |       |                 |
| 0.1                | 0.715           | -166.0         | 36.507          | 120.1          | 0.012           | 49.8           | 0.607           | -121.9         | 0.629 | 34.77           |
| 0.2                | 0.801           | -177.8         | 21.860          | 103.7          | 0.016           | 60.9           | 0.628           | -152.6         | 0.840 | 31.31           |
| 0.3                | 0.801           | 178.2          | 14.764          | 94.7           | 0.020           | 61.4           | 0.625           | -164.1         | 0.911 | 28.66           |
| 0.4                | 0.807           | 174.8          | 11.180          | 89.7           | 0.025           | 62.9           | 0.633           | -171.8         | 0.955 | 26.52           |
| 0.5                | 0.804           | 172.2          | 8.871           | 86.0           | 0.030           | 64.0           | 0.633           | -177.4         | 0.994 | 24.72           |
| 0.6                | 0.804           | 169.3          | 7.403           | 81.9           | 0.035           | 64.1           | 0.638           | 178.3          | 1.011 | 22.61           |
| 0.7                | 0.816           | 167.0          | 6.346           | 79.1           | 0.040           | 63.6           | 0.641           | 174.5          | 1.008 | 21.43           |
| 0.8                | 0.816           | 164.9          | 5.531           | 76.0           | 0.046           | 62.7           | 0.641           | 171.4          | 1.016 | 20.08           |
| 0.9                | 0.817           | 162.9          | 4.899           | 73.2           | 0.050           | 61.9           | 0.647           | 168.4          | 1.024 | 18.95           |
| 1.0                | 0.821           | 160.7          | 4.409           | 70.9           | 0.055           | 60.9           | 0.647           | 165.6          | 1.026 | 18.04           |
| 1.1                | 0.820           | 158.7          | 3.984           | 68.6           | 0.060           | 59.9           | 0.655           | 163.1          | 1.033 | 17.11           |
| 1.2                | 0.822           | 156.8          | 3.641           | 66.1           | 0.065           | 58.6           | 0.657           | 160.4          | 1.037 | 16.33           |
| 1.3                | 0.826           | 155.1          | 3.366           | 63.5           | 0.070           | 57.5           | 0.661           | 158.2          | 1.032 | 15.75           |
| 1.4                | 0.829           | 153.2          | 3.111           | 61.5           | 0.074           | 55.8           | 0.663           | 155.7          | 1.034 | 15.10           |
| 1.5                | 0.828           | 151.2          | 2.891           | 59.3           | 0.079           | 54.2           | 0.663           | 153.7          | 1.039 | 14.44           |
| 1.6                | 0.829           | 149.1          | 2.702           | 57.2           | 0.083           | 52.6           | 0.671           | 151.3          | 1.042 | 13.88           |
| 1.7                | 0.832           | 147.3          | 2.528           | 54.9           | 0.087           | 51.4           | 0.673           | 149.2          | 1.043 | 13.35           |
| 1.8                | 0.835           | 145.3          | 2.382           | 52.4           | 0.091           | 49.5           | 0.680           | 147.0          | 1.042 | 12.92           |
| 1.9                | 0.833           | 143.6          | 2.246           | 50.5           | 0.095           | 48.1           | 0.681           | 145.1          | 1.049 | 12.37           |
| 2.0                | 0.840           | 141.3          | 2.116           | 48.0           | 0.099           | 46.5           | 0.684           | 143.3          | 1.044 | 12.01           |
| 2.1                | 0.843           | 138.9          | 1.997           | 45.7           | 0.103           | 45.0           | 0.688           | 141.3          | 1.046 | 11.57           |
| 2.2                | 0.847           | 136.9          | 1.904           | 43.6           | 0.106           | 43.5           | 0.690           | 139.5          | 1.043 | 11.26           |
| 2.3                | 0.844           | 134.8          | 1.814           | 41.6           | 0.109           | 42.0           | 0.699           | 137.6          | 1.053 | 10.79           |
| 2.4                | 0.848           | 133.0          | 1.724           | 39.8           | 0.112           | 40.3           | 0.703           | 136.1          | 1.053 | 10.47           |
| 2.5                | 0.855           | 130.8          | 1.641           | 37.7           | 0.115           | 38.5           | 0.712           | 134.4          | 1.047 | 10.21           |
| 2.6                | 0.858           | 129.1          | 1.555           | 36.1           | 0.118           | 37.0           | 0.710           | 133.1          | 1.050 | 9.84            |
| 2.7                | 0.859           | 127.1          | 1.480           | 34.0           | 0.121           | 35.5           | 0.720           | 131.4          | 1.053 | 9.47            |
| 2.8                | 0.864           | 125.4          | 1.412           | 32.3           | 0.122           | 34.5           | 0.722           | 130.0          | 1.055 | 9.19            |
| 2.9                | 0.873           | 123.9          | 1.345           | 30.4           | 0.124           | 33.4           | 0.726           | 128.5          | 1.048 | 9.02            |
| 3.0                | 0.876           | 122.6          | 1.295           | 28.7           | 0.126           | 32.5           | 0.728           | 126.9          | 1.048 | 8.78            |
| 4.0                | 0.879           | 112.9          | 0.937           | 15.8           | 0.149           | 22.0           | 0.757           | 111.9          | 1.076 | 6.29            |
| 5.0                | 0.901           | 99.8           | 0.717           | 1.4            | 0.162           | 9.8            | 0.795           | 101.9          | 1.061 | 4.96            |

$V_{CE} = 3\text{ V}$ ,  $I_C = 300\text{ mA}$ ,  $Z_0 = 50\ \Omega$

| Frequency<br>(GHz) | S <sub>11</sub> |                | S <sub>21</sub> |                | S <sub>12</sub> |                | S <sub>22</sub> |                | K     | MAG/MSG<br>(dB) |
|--------------------|-----------------|----------------|-----------------|----------------|-----------------|----------------|-----------------|----------------|-------|-----------------|
|                    | MAG.            | ANG.<br>(deg.) | MAG.            | ANG.<br>(deg.) | MAG.            | ANG.<br>(deg.) | MAG.            | ANG.<br>(deg.) |       |                 |
| 0.1                | 0.754           | -170.5         | 33.599          | 120.7          | 0.011           | 49.1           | 0.576           | -127.2         | 0.713 | 34.99           |
| 0.2                | 0.816           | -179.5         | 19.900          | 104.0          | 0.015           | 63.0           | 0.612           | -156.1         | 0.901 | 31.33           |
| 0.3                | 0.817           | 177.4          | 13.409          | 94.6           | 0.020           | 63.5           | 0.612           | -166.4         | 0.945 | 28.31           |
| 0.4                | 0.820           | 174.0          | 10.129          | 89.5           | 0.025           | 65.0           | 0.621           | -173.6         | 0.987 | 26.14           |
| 0.5                | 0.820           | 171.5          | 8.019           | 85.5           | 0.029           | 65.6           | 0.623           | -178.9         | 1.017 | 23.54           |
| 0.6                | 0.818           | 168.7          | 6.699           | 81.6           | 0.035           | 65.7           | 0.628           | 177.0          | 1.035 | 21.72           |
| 0.7                | 0.829           | 166.8          | 5.732           | 78.7           | 0.040           | 64.7           | 0.631           | 173.4          | 1.026 | 20.57           |
| 0.8                | 0.829           | 164.4          | 5.009           | 75.6           | 0.045           | 64.1           | 0.631           | 170.4          | 1.035 | 19.31           |
| 0.9                | 0.830           | 162.4          | 4.438           | 72.9           | 0.050           | 63.3           | 0.637           | 167.6          | 1.043 | 18.24           |
| 1.0                | 0.834           | 160.3          | 3.991           | 70.4           | 0.055           | 61.9           | 0.637           | 164.8          | 1.043 | 17.38           |
| 1.1                | 0.830           | 158.3          | 3.607           | 68.2           | 0.060           | 60.9           | 0.645           | 162.4          | 1.054 | 16.39           |
| 1.2                | 0.835           | 156.6          | 3.295           | 65.5           | 0.064           | 59.6           | 0.648           | 159.6          | 1.052 | 15.71           |
| 1.3                | 0.835           | 154.7          | 3.047           | 63.0           | 0.069           | 58.2           | 0.651           | 157.6          | 1.054 | 15.03           |
| 1.4                | 0.838           | 152.9          | 2.815           | 60.9           | 0.074           | 56.6           | 0.654           | 155.2          | 1.053 | 14.41           |
| 1.5                | 0.840           | 150.7          | 2.618           | 58.6           | 0.078           | 54.9           | 0.655           | 153.1          | 1.054 | 13.82           |
| 1.6                | 0.841           | 149.0          | 2.448           | 56.5           | 0.082           | 53.3           | 0.661           | 150.8          | 1.058 | 13.26           |
| 1.7                | 0.841           | 147.0          | 2.292           | 54.1           | 0.087           | 51.9           | 0.663           | 148.6          | 1.061 | 12.71           |
| 1.8                | 0.846           | 145.0          | 2.159           | 51.6           | 0.091           | 50.2           | 0.670           | 146.5          | 1.057 | 12.31           |
| 1.9                | 0.841           | 143.1          | 2.034           | 49.8           | 0.095           | 48.7           | 0.671           | 144.7          | 1.071 | 11.69           |
| 2.0                | 0.852           | 140.7          | 1.919           | 47.1           | 0.099           | 47.0           | 0.673           | 142.8          | 1.056 | 11.44           |
| 2.1                | 0.854           | 138.7          | 1.810           | 45.0           | 0.102           | 45.6           | 0.678           | 141.0          | 1.060 | 10.98           |
| 2.2                | 0.857           | 136.9          | 1.729           | 42.8           | 0.106           | 44.0           | 0.680           | 139.1          | 1.058 | 10.66           |
| 2.3                | 0.855           | 134.5          | 1.648           | 40.8           | 0.109           | 42.5           | 0.691           | 137.4          | 1.065 | 10.24           |
| 2.4                | 0.858           | 132.6          | 1.565           | 38.9           | 0.111           | 40.7           | 0.693           | 135.8          | 1.069 | 9.87            |
| 2.5                | 0.863           | 130.6          | 1.491           | 36.7           | 0.114           | 38.9           | 0.700           | 134.1          | 1.063 | 9.61            |
| 2.6                | 0.866           | 128.9          | 1.412           | 35.1           | 0.117           | 37.4           | 0.701           | 132.8          | 1.066 | 9.23            |
| 2.7                | 0.870           | 126.7          | 1.345           | 33.0           | 0.120           | 35.9           | 0.709           | 131.3          | 1.063 | 8.95            |
| 2.8                | 0.872           | 125.0          | 1.286           | 31.2           | 0.122           | 34.9           | 0.711           | 129.8          | 1.069 | 8.64            |
| 2.9                | 0.880           | 123.7          | 1.229           | 29.5           | 0.124           | 33.9           | 0.716           | 128.4          | 1.060 | 8.48            |
| 3.0                | 0.883           | 122.4          | 1.182           | 27.6           | 0.125           | 32.9           | 0.719           | 126.7          | 1.062 | 8.23            |
| 4.0                | 0.885           | 112.6          | 0.859           | 14.5           | 0.149           | 22.5           | 0.749           | 111.9          | 1.094 | 5.74            |
| 5.0                | 0.905           | 99.4           | 0.662           | 0.3            | 0.161           | 10.2           | 0.787           | 101.8          | 1.076 | 4.45            |

$V_{CE} = 3\text{ V}$ ,  $I_C = 400\text{ mA}$ ,  $Z_0 = 50\ \Omega$

| Frequency<br>(GHz) | S <sub>11</sub> |                | S <sub>21</sub> |                | S <sub>12</sub> |                | S <sub>22</sub> |                | K     | MAG/MSG<br>(dB) |
|--------------------|-----------------|----------------|-----------------|----------------|-----------------|----------------|-----------------|----------------|-------|-----------------|
|                    | MAG.            | ANG.<br>(deg.) | MAG.            | ANG.<br>(deg.) | MAG.            | ANG.<br>(deg.) | MAG.            | ANG.<br>(deg.) |       |                 |
| 0.1                | 0.806           | -172.5         | 22.733          | 122.7          | 0.008           | 51.5           | 0.536           | -143.9         | 1.023 | 33.34           |
| 0.2                | 0.852           | -179.9         | 13.532          | 105.3          | 0.015           | 63.9           | 0.596           | -165.2         | 0.994 | 29.55           |
| 0.3                | 0.858           | 176.5          | 9.140           | 95.0           | 0.019           | 63.2           | 0.602           | -172.6         | 1.031 | 25.69           |
| 0.4                | 0.862           | 173.2          | 6.905           | 89.5           | 0.024           | 64.5           | 0.614           | -178.2         | 1.055 | 23.08           |
| 0.5                | 0.860           | 170.6          | 5.470           | 85.4           | 0.029           | 65.6           | 0.617           | 177.4          | 1.090 | 20.87           |
| 0.6                | 0.857           | 168.1          | 4.566           | 81.3           | 0.035           | 65.6           | 0.623           | 173.9          | 1.106 | 19.21           |
| 0.7                | 0.865           | 165.8          | 3.911           | 78.2           | 0.040           | 65.3           | 0.626           | 170.8          | 1.098 | 18.02           |
| 0.8                | 0.867           | 163.7          | 3.417           | 75.0           | 0.045           | 64.1           | 0.625           | 168.0          | 1.098 | 16.91           |
| 0.9                | 0.866           | 161.5          | 3.029           | 72.0           | 0.049           | 63.3           | 0.631           | 165.5          | 1.112 | 15.83           |
| 1.0                | 0.868           | 159.7          | 2.726           | 69.6           | 0.054           | 62.0           | 0.631           | 162.9          | 1.111 | 14.97           |
| 1.1                | 0.865           | 157.7          | 2.467           | 67.1           | 0.059           | 60.9           | 0.640           | 160.6          | 1.129 | 14.04           |
| 1.2                | 0.868           | 155.8          | 2.256           | 64.4           | 0.064           | 59.6           | 0.641           | 158.2          | 1.124 | 13.34           |
| 1.3                | 0.869           | 154.0          | 2.089           | 61.8           | 0.069           | 58.1           | 0.646           | 156.2          | 1.121 | 12.72           |
| 1.4                | 0.872           | 152.2          | 1.932           | 59.5           | 0.073           | 56.6           | 0.647           | 153.8          | 1.119 | 12.11           |
| 1.5                | 0.872           | 149.9          | 1.801           | 57.3           | 0.078           | 55.0           | 0.648           | 151.9          | 1.126 | 11.51           |
| 1.6                | 0.871           | 148.0          | 1.688           | 54.9           | 0.082           | 53.3           | 0.655           | 149.6          | 1.129 | 10.95           |
| 1.7                | 0.874           | 146.1          | 1.583           | 52.5           | 0.086           | 52.0           | 0.656           | 147.6          | 1.126 | 10.48           |
| 1.8                | 0.877           | 144.1          | 1.492           | 50.0           | 0.091           | 50.2           | 0.664           | 145.5          | 1.120 | 10.06           |
| 1.9                | 0.872           | 142.3          | 1.411           | 48.1           | 0.094           | 48.8           | 0.664           | 143.7          | 1.140 | 9.47            |
| 2.0                | 0.881           | 140.0          | 1.334           | 45.3           | 0.098           | 47.2           | 0.668           | 141.8          | 1.120 | 9.23            |
| 2.1                | 0.882           | 137.8          | 1.259           | 42.9           | 0.102           | 45.8           | 0.671           | 140.0          | 1.124 | 8.77            |
| 2.2                | 0.886           | 135.8          | 1.205           | 40.7           | 0.105           | 44.2           | 0.672           | 138.4          | 1.115 | 8.53            |
| 2.3                | 0.881           | 133.7          | 1.152           | 38.7           | 0.108           | 42.5           | 0.683           | 136.4          | 1.135 | 8.04            |
| 2.4                | 0.884           | 131.7          | 1.095           | 36.8           | 0.111           | 40.9           | 0.685           | 135.0          | 1.135 | 7.71            |
| 2.5                | 0.888           | 129.7          | 1.046           | 34.6           | 0.114           | 39.1           | 0.695           | 133.4          | 1.127 | 7.46            |
| 2.6                | 0.889           | 128.0          | 0.994           | 32.8           | 0.117           | 37.5           | 0.692           | 132.2          | 1.134 | 7.08            |
| 2.7                | 0.892           | 126.0          | 0.948           | 30.7           | 0.120           | 36.0           | 0.700           | 130.5          | 1.130 | 6.80            |
| 2.8                | 0.894           | 124.3          | 0.908           | 28.9           | 0.121           | 35.1           | 0.702           | 129.2          | 1.137 | 6.51            |
| 2.9                | 0.905           | 123.1          | 0.868           | 27.0           | 0.123           | 34.2           | 0.706           | 127.9          | 1.110 | 6.48            |
| 3.0                | 0.904           | 121.6          | 0.838           | 25.2           | 0.125           | 33.3           | 0.709           | 126.4          | 1.120 | 6.17            |
| 4.0                | 0.902           | 111.8          | 0.624           | 11.8           | 0.149           | 22.8           | 0.740           | 111.8          | 1.160 | 3.81            |
| 5.0                | 0.917           | 98.8           | 0.496           | -2.3           | 0.161           | 10.5           | 0.779           | 101.9          | 1.129 | 2.71            |

PACKAGE DIMENSIONS

FLAT-LEAD 4-PIN THIN-TYPE SUPER MINIMOLD (UNIT: mm)

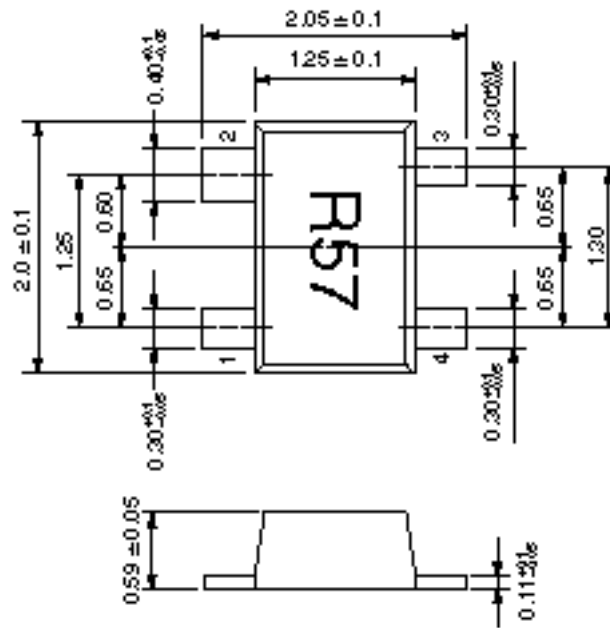
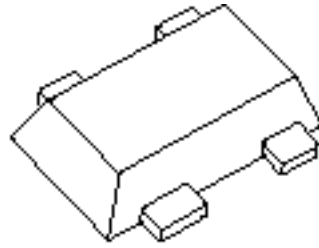

PIN CONNECTIONS

- 1. Emitter
- 2. Collector
- 3. Emitter
- 4. Base