

USB3803 WLCSP-EVB Evaluation Board User Manual

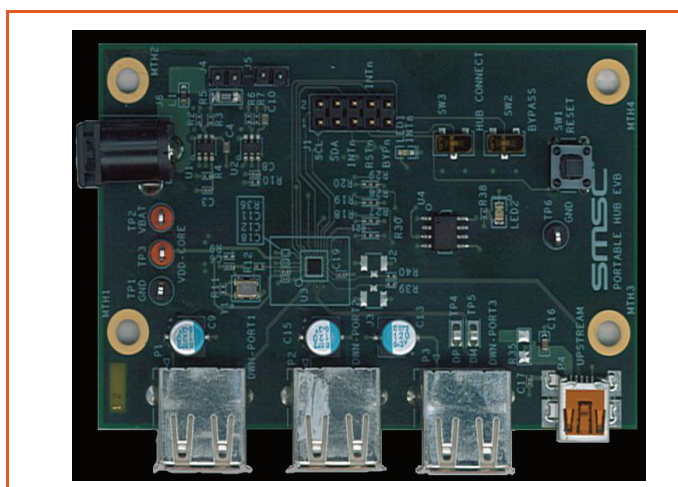

Copyright © 2012 SMSC or its subsidiaries. All rights reserved.

Circuit diagrams and other information relating to SMSC products are included as a means of illustrating typical applications. Consequently, complete information sufficient for construction purposes is not necessarily given. Although the information has been checked and is believed to be accurate, no responsibility is assumed for inaccuracies. SMSC reserves the right to make changes to specifications and product descriptions at any time without notice. Contact your local SMSC sales office to obtain the latest specifications before placing your product order. The provision of this information does not convey to the purchaser of the described semiconductor devices any licenses under any patent rights or other intellectual property rights of SMSC or others. All sales are expressly conditional on your agreement to the terms and conditions of the most recently dated version of SMSC's standard Terms of Sale Agreement dated before the date of your order (the "Terms of Sale Agreement"). The product may contain design defects or errors known as anomalies which may cause the product's functions to deviate from published specifications. Anomaly sheets are available upon request. SMSC products are not designed, intended, authorized or warranted for use in any life support or other application where product failure could cause or contribute to personal injury or severe property damage. Any and all such uses without prior written approval of an Officer of SMSC and further testing and/or modification will be fully at the risk of the customer. Copies of this document or other SMSC literature, as well as the Terms of Sale Agreement, may be obtained by visiting SMSC's website at <http://www.smSC.com>. SMSC is a registered trademark of Standard Microsystems Corporation ("SMSC"). Product names and company names are the trademarks of their respective holders.

The Microchip name and logo, and the Microchip logo are registered trademarks of Microchip Technology Incorporated in the U.S.A. and other countries.

SMSC DISCLAIMS AND EXCLUDES ANY AND ALL WARRANTIES, INCLUDING WITHOUT LIMITATION ANY AND ALL IMPLIED WARRANTIES OF MERCHANTABILITY, FITNESS FOR A PARTICULAR PURPOSE, TITLE, AND AGAINST INFRINGEMENT AND THE LIKE, AND ANY AND ALL WARRANTIES ARISING FROM ANY COURSE OF DEALING OR USAGE OF TRADE. IN NO EVENT SHALL SMSC BE LIABLE FOR ANY DIRECT, INCIDENTAL, INDIRECT, SPECIAL, PUNITIVE, OR CONSEQUENTIAL DAMAGES; OR FOR LOST DATA, PROFITS, SAVINGS OR REVENUES OF ANY KIND; REGARDLESS OF THE FORM OF ACTION, WHETHER BASED ON CONTRACT; TORT; NEGLIGENCE OF SMSC OR OTHERS; STRICT LIABILITY; BREACH OF WARRANTY; OR OTHERWISE; WHETHER OR NOT ANY REMEDY OF BUYER IS HELD TO HAVE FAILED OF ITS ESSENTIAL PURPOSE, AND WHETHER OR NOT SMSC HAS BEEN ADVISED OF THE POSSIBILITY OF SUCH DAMAGES.

1 Introduction

This user manual is for the USB3803 Evaluation board. This board can be used to test and evaluate the functionality of the USB3803 and is ideal for early system integration and software development. The USB3803 EVB provides access to the USB upstream and downstream ports, as well as the I²C communication pins.

SMSC has evaluation software that can be used with the USB3803 EVB connected to a Total Phase Aardvark adaptor. This software allows the user to configure the USB3803 in different ways before enumeration and access select status registers during enumeration. The software can be used to prototype microprocessor software, evaluate the different configurations, and test how the desired configuration fits into the entire system.

2 Operation

2.1 Contents of the Kit

The USB3803 EVB includes the basic equipment necessary to evaluate the USB3803. The items included in the kit are:

1. USB3803 EVB
2. 5V DC Power Supply
3. USB A to Mini-B cable
4. Documentation and Software CD

The kit does **not** include any downstream USB devices, I²C master hardware, or other components for board customization.

2.2 Initial Configuration

The USB3803 EVB default configuration configures it to operate as a stand alone hub. To begin, plug the evaluation board into the 5V power supply. After the board is powered up, plug the upstream port into a standard PC host. The USB3803 EVB will enumerate as a Generic USB Hub, with the VID and PID equal to the default values found in the USB3803 Datasheet.

The default configuration of the USB3803 is to enumerate as a Bus Powered Hub. This means that, according to the USB 2.0 specification, the downstream ports are only allowed to provide 100mA of current to the downstream device. Although the evaluation board is designed to provide much more current to the downstream ports, the PC host may generate an error. To avoid this condition, only connect self powered USB 2.0 devices to the downstream ports when using the USB3803 EVB in it's default state. The USB3803 can also be configured as a Self Powered Hub through the I²C Serial Interface Registers. This will eliminate the 100mA limit error reported by the host PC. Refer to the datasheet for more details.

Refer to the next chapters to see the customization options associated with the evaluation kit.

3 Hardware

The USB3803 EVB is a board that shows the capabilities of the USB3803. The board consists of the USB upstream and downstream ports, a INT_N LED for visual confirmation of the interrupts configured, a header exposing the I²C pins, and additional circuitry that is used for I²C communication.

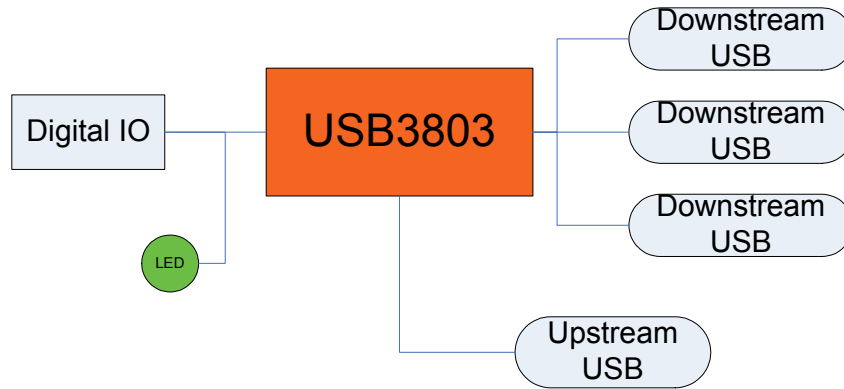

Figure 3.1 Block Diagram of the USB3803 EVB

3.1 USB Ports

The USB ports are mounted on the edges of the USB3803 EVB. The downstream ports use the standard USB Type A receptacle. The label for the port is located near the receptacle. The USB upstream port is a standard mini-B receptacle.

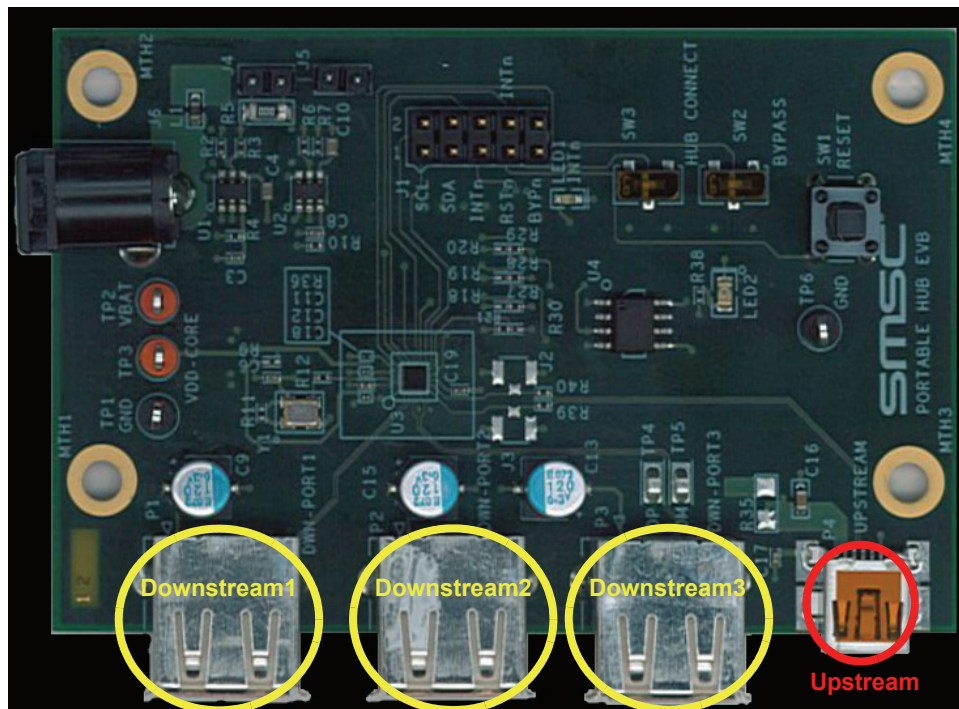

Figure 3.2 Upstream and Downstream Ports

3.2 Test Points, Switches and LEDs

There are multiple test points to confirm that the USB3803 EVB is powered properly. **TP1** and **TP6** connect to GND; **TP2** connects to the VBAT pin, and **TP3** connects to the VDD_CORE_REG pin.

The USB3803 EVB also has three switches to manually control the RESET_N, BYPASS_N and HUB_CONNECT inputs to the part. [Figure 3.3](#) shows the location of the test points (Red) and switches (Yellow).

The USB3803 SCL, SDA, RESET_N, BYPASS_N, HUB_CONNECT and INT_B pins are also exposed on the **J1** header. These pins are compatible with the Total Phase Aardvark pinout, where pin 1 of the Aardvark connector connects to pin 1 of header J1 (Refer to [Figure 4.1](#) for the proper way to connect the Aardvark). The INT_N pin is also connected to **LED1** to indicate that an interrupt has occurred. The LED remains lit until the interrupt is cleared, as described in the USB3803 datasheet

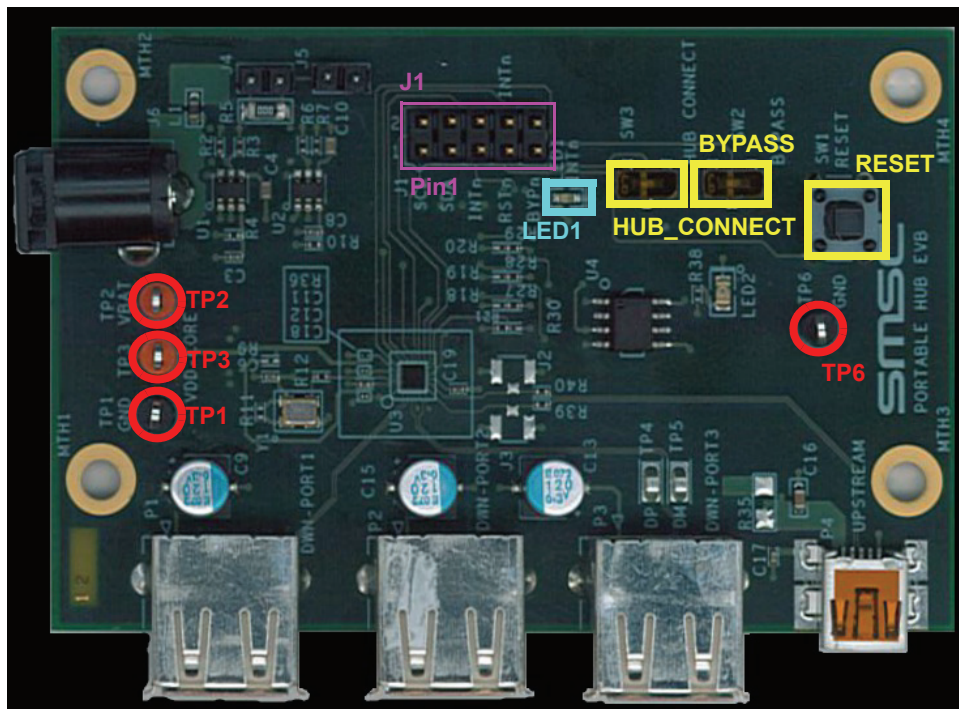

Figure 3.3 Test points, Switches, Header and LED

3.3 Configuration Resistors

There are eight different resistors used to configure the part when the RESET_N pin transitions from Low (0V) to High (>1.25V). These resistors are used for the REF_SEL and I2C_ASEL pins. Because these resistors and pads connect to the 1.8V regulator, any changes to these resistors will need to be done with the board unpowered. The resistor pads are laid out in a manner that prevents the pull-up resistors from being populated at the same time as the pull-down resistors, as shown in [Figure 3.4](#). The following tables show the proper configuration resistor population requirements for the desired results, the resistor values should match those found in [Section 6](#), "USB3803 EVB Bill of Materials".

Note: The Y1 Oscillator will need to be replaced with the proper frequency if the REF_SEL pins are altered. Refer to [Section 6, "USB3803 EVB Bill of Materials"](#) for recommended oscillator specifications.

Table 3.1 REF_SEL Options

R18	R21	R27	R30	REFCLK(MHZ)
EMPTY	EMPTY	INSTALL	INSTALL	38.4
EMPTY	INSTALL	INSTALL	EMPTY	26.0 (Default)
INSTALL	EMPTY	EMPTY	INSTALL	19.2
INSTALL	INSTALL	EMPTY	EMPTY	12.0

Table 3.2 I²C Address Selection Options

R19	R20	R28	R29	I ² C ADDRESS
EMPTY	EMPTY	INSTALL	INSTALL	08h (Default)
INSTALL	EMPTY	EMPTY	INSTALL	09h
EMPTY	INSTALL	INSTALL	EMPTY	28h
INSTALL	INSTALL	EMPTY	EMPTY	29h

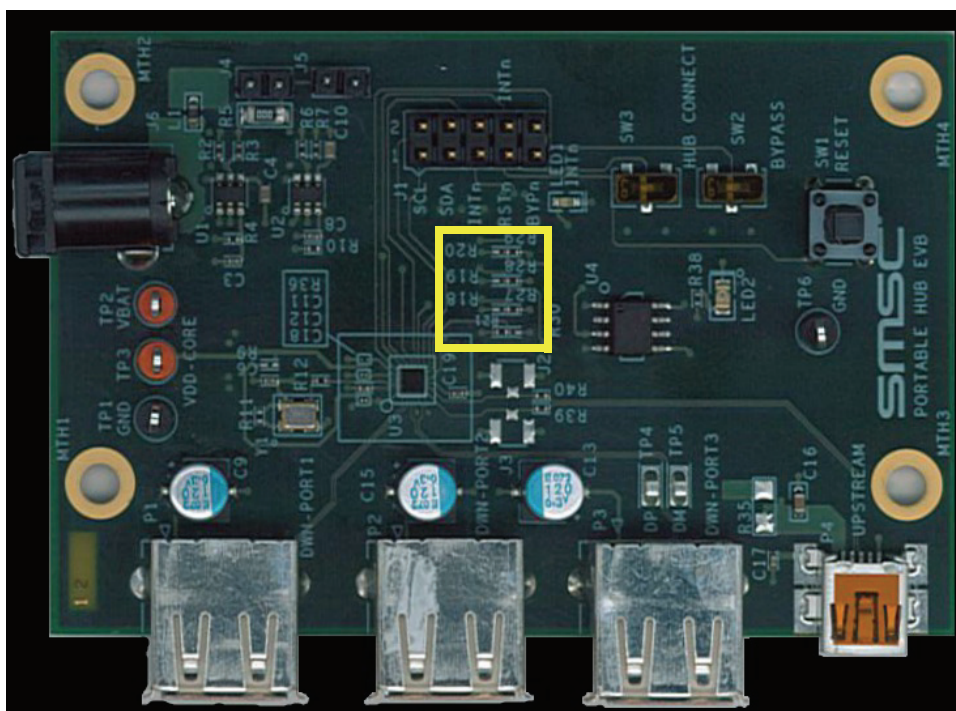

Figure 3.4 Configuration Resistors

3.4 Additional Circuitry

The U1 Regulator provides 3.3V to the VBAT pin, and also supplies power to the 26MHz clock oscillator. If a higher VBAT voltage is desired, remove **R1** and supply the power through **TP2**.

The U2 Regulator provides 1.8V to the VDD_CORE_REG pin as well as providing the pull up voltage for the digital control pins. To provide external power to the VDD_CORE_REG pin remove **R8** and supply the power through **TP3**.

The USB3803 can function with a single power supply; to do this remove **R8** and place a 0Ohm resistor on **R9**. This connects the VDD_CORE_REG pin to the VDD33_BYP pin allowing the USB3803's internal 3.3V regulator to supply the VDD_CORE_REG voltage.

Below is a summary of the different power options and what resistors need to be populated to support these options:

Table 3.3 VBAT and VDD_CORE_REG source control

R1	R8	R9	VBAT SOURCE	VDD_CORE_REG SOURCE
INSTALL	INSTALL	EMPTY	Onboard Regulator	Onboard Regulator
EMPTY	INSTALL	EMPTY	External (TP2)	Onboard Regulator
EMPTY	EMPTY	EMPTY	External (TP2)	External (TP3)
INSTALL	EMPTY	INSTALL	Onboard Regulator	VDD33_BYP
EMPTY	EMPTY	INSTALL	External (TP2)	VDD33_BYP

The USB3803 EVB also has an option to supply the 5V reference from two different voltage sources. The 5V can come from the upstream USB VBUS or from an external 5V supply. To supply the 5V voltage from the upstream USB port, remove **R5** and populate **R35** with a 0Ohm resistor. The default is to supply the 5V from an external source.

Table 3.4 5V Reference Source

R5	R35	5V SOURCE
INSTALL	EMPTY	External 5V Supply
EMPTY	INSTALL	Upstream VBUS

Below are the locations of the resistors on the back side of the board:

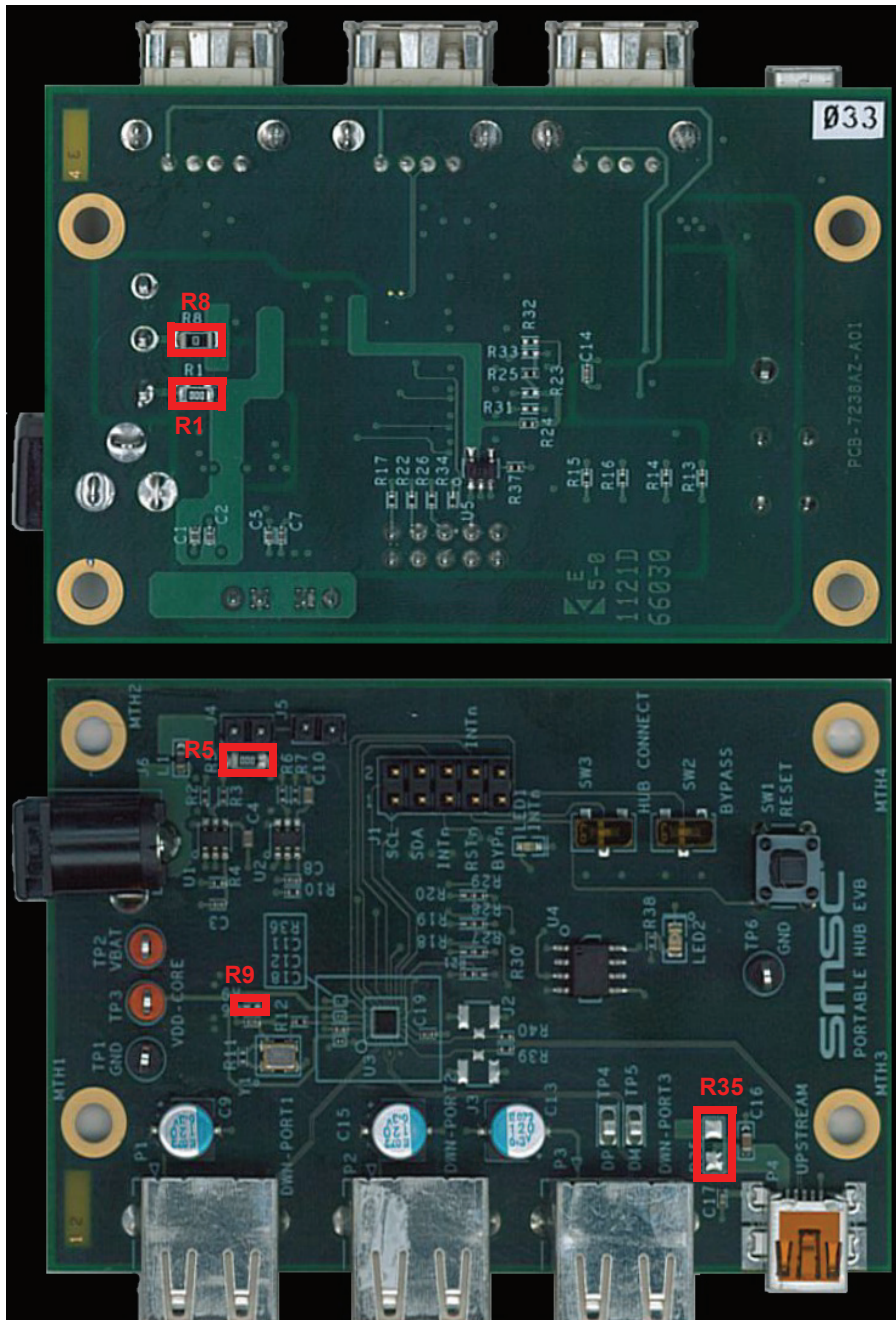

Figure 3.5 Regulator resistors

4 Software

The USB3803 EVB comes with a CD that contains evaluation software that can be used with the Total Phase Aardvark USB-I²C adaptor (not included with the Evaluation Kit). To install the software, run **Setup.exe**, found on the CD. This will install the USB3803 Evaluation Software, the LabVIEW Runtime engine (to run the executable), and the Total Phase drivers to communicate with the Aardvark. Once the software has been installed, locate and run the **USB3803 Evaluation.exe** program on the computer. Connect the Aardvark to the USB3803 EVB with the red wire facing the power port, as in Figure 4.1.



Figure 4.1 Aardvark Connection

The software allows the user to control the digital input pins RESET_N, CONNECT, and BYPASS_N. It also can monitor the INT_N pin for interrupts. There is a section to communicate with the I²C serial port, as well as some quick configuration and customization options.



Figure 4.2 USB3803 Evaluation Screen

4.1 Digital Control

The RESET_N, HUB_CONNECT and BYPASS_N pins can be controlled in real time with the **Digital Control** array. Each button in the array corresponds to the pin with the matching name. When the button is orange, the pin is at logic level High. When the button is black the voltage is a logic level Low. Refer to the green box in Figure 4.3 for the digital control array location.

Set the RESET_N pin low to reset the part and place it into the lowest power state. If the CONNECT pin is low when the RESET pin transitions from low to high, the USB3803 will remain in a state that allows the serial interface registers to be manipulated. To enumerate the hub, either write 00h to register E7h, or drive the CONNECT pin high. Once the USB3803 has enumerated, the serial interface registers should not be modified.

To test the bypass switch functionality, and run the USB3803 in another low power state, set the BYPASS_N pin low. For more information refer to the datasheet for a complete description of each pin's functionality.

Notes: To prevent the Aardvark from driving against another voltage, the Aardvark is operates in Open/Drain mode, therefore it is important that all switches on the board are set to the high position, pulling the pins high.



Figure 4.3 Digital Control (Green) and I²C (Yellow) sections

4.2 I²C Communication

This application also contains a general I²C register read/write section. The **Bit** and **Description** display the serial interface register descriptions found in the USB3803 datasheet. The **Register** display can be used to select the proper serial interface register to manipulate. Click on the **Value** or **Bit** box above to change the value of the register. Once the desired value and register are selected, press the **Write** button to change the value on the part. Click on the **Read** button and the **Value** and **Bit** boxes

will update the current value on the part. Refer to the USB3803 datasheet for a detailed description of each register and operation of the device

4.3 Quick Configuration and Customization

The USB3803 Evaluation program also contains some quick configuration and customization options that automatically update the registers to match the desired configuration. The USB3803 can enumerate as a Self Powered or Bus Powered Hub with 1, 2 or 3 downstream ports. The VID, PID, DID and enumeration strings can also be customized to allow the USB3803 to enumerate with whatever identification is desired.

To change these values; update the configuration section to the desired options, then press the **Configure** button. The part will then reset, pull the CONNECT pin low and update the registers as specified. To enumerate with these options either raise the CONNECT pin, or press the **Connect** button.



Figure 4.4 Quick Configuration Options

5 USB3803 EVB Schematic

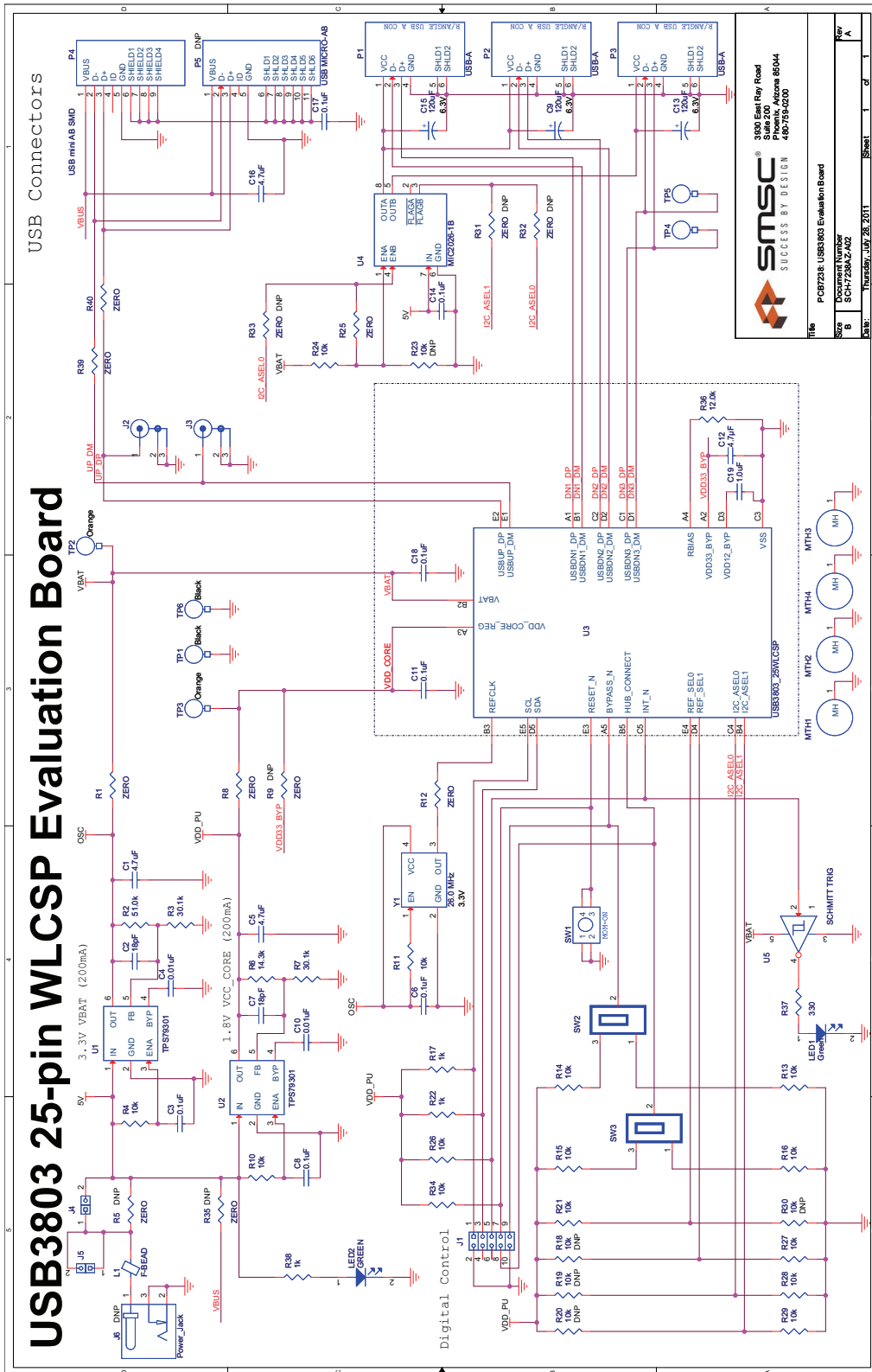

Figure 5.1 USB3803 EVB Schematic

6 USB3803 EVB Bill of Materials

Part ID	Quantity	Part Reference	Description	Digikey Number	Manuf	Manuf PN	RoHS	DNP
1	2	C1 C5	CAP CER 4.7UF 4V X5R 0402	587-1866-1-ND	Taiyo Yuden	AMK106B4J75MV-F	Yes	
2	2	C2 C7	CAPACITOR CERAMIC 18PF 50V 0402 SMD	PCC180CCT-ND	PANASONIC	ECJ-0EC1H180J	Yes	
3	7	C3 C8 C14 C17	CAPACITOR CERAMIC 0.1UF 10V X5R 0402	PCC2146CT-ND	PANASONIC	ECJ-0EB1A104K	Yes	
4	2	C4 C10	CAPACITOR CERAMIC 0.01UF 16V 10% X7R 0402	PCC103BQCT-ND	PANASONIC	ECJ-0EB1C103K	Yes	
5	3	C9 C13 C15	CAP 120UF 6.3V ELECT POLY SMD	565-3188-1-ND	United Chemi-Con	APXJ6R3ARA121ME61G	Yes	
6	2	C11 C18	CAP CER 1UF 6.3V X5R 0201	490-3167-1-ND	MURATA ERIE	GRM033R60J104KE19D	Yes	
7	1	C12	CAP CER 4.7UF 6.3V X5R 0402	490-5408-1-ND	MURATA ERIE	GRM155R60J475ME87D	Yes	
8	1	C16	CAPACITOR CERAMIC 4.7UF 6.3V 20% X5R 0402	445-1417-1-ND	TDK	C160X6R0475M	Yes	
9	1	C19	CAPACITOR CERAMIC 1.0UF 6.3V 20% X5R 0402	490-1319-1-ND	MURATA ERIE	GRMT55R60J105ME19D	Yes	
10	1	J1	HEADER, 2 X 5, 0.1 INCH, VERTICAL	SAM1030-05-ND	SAMTEC	TSW-105-07-L-D	Yes	
11	J2		CONN RECEPT ULTRA-MINI COAX AMD	H9161CT-ND	HIROSE	UJFLR-SMT (10)	Yes	J2
12	J3		CONN RECEPT ULTRA-MINI COAX AMD	H9161CT-ND	HIROSE	UJFLR-SMT (10)	Yes	J3
13	2	J4 J5	HEADER, 1 X 2, 0.1 INCH, VERTICAL	WM6402-ND	MOLEX	22-28-4020	Yes	
14	1	J6	CONNECTOR POWER JACK 2.1X5.5MM HIGH CURR	CP-002AH-ND	CUI STACK	PJ-002AH	Yes	
15	1	L1	FERRITE BEAD, 120 OHM, 0.5A, 0.1DCR, 0603	P10750CT-ND	PANASONIC	EXC-3BP121H	Yes	
16	1	LED1	LED GREEN SMT	404-1005-1-ND	STANLEY	BG1111C-TR	Yes	
17	1	LED2	LED GREEN 2X1.2MM 568NM GN WTR CLR SMD	754-1131-1-ND	Kingbright	APT2012SGC	Yes	
18	4	MTH1 MTH2 MTH3 MTH4	MOUNTING PAD MTG250C140D	609-1045-ND	FCI	87520-0010BLF	Yes	
19	3	P1 P2 P3	RECEPTACLE, USB, STYLE B, RIGHT ANGLE	WM171Z2CT-ND	MOLEX	56579-0576	Yes	
20	1	P4	CONNECTOR RECEIPT USB MINI AB 5POS RT ANG	A97799CT-ND	TYCO ELECTRONICS	1981884-1	Yes	P5
21	0	P5	CONNECTOR RECEIPT MICRO USB TYPE AB SMT	311-0-0ERCT-ND	YAGEO	RC1206JR-070RL	Yes	P5
22	2	R1 R5 R8 R35	RESISTOR ZERO OHM 1/4W 5% 1206	P31-0-KLCT-ND	YAGEO	ERJ-2RKF5102X	Yes	R1 R5 R35
23	1	R2	RES 51.0K OHM 1/10W 1% 0402 SMD	P50.1KLCT-ND	Panasonic - ECG	ERJ-2RKF3012X	Yes	
24	2	R3 R7	RES 30.1K OHM 1/10W 1% 0402 SMD	P30.1KLCT-ND	Panasonic - ECG	ERJ-2RKF3012X	Yes	
25	15	R4 R10 R11 R13 R14 R15 R16 R18 R19 R20 R21 R23 R24 R26 R27 R28 R29 R30 R34	RESISTOR 10K OHM 1/16W 5% 0402 SMD	P10KJCT-ND	PANASONIC	ERJ-2GE1103X	Yes	R18 R19 R20 R23 R30
26	1	R6	RES 14.3K OHM 1/10W 1% 0402 SMD	P14.3KLCT-ND	Panasonic - ECG	ERJ-2RKF1432X	Yes	
27	4	R40	RESISTOR ZERO OHM 1/16W 5% 0402 SMD	311-0-0JRCT-ND	YAGEO	RC0402JR-070RL	Yes	R9 R33 R31 R32
28	3	R17 R22 R38	RESISTOR 1.0K OHM 1/16W 5% 0402 SMD	P1.0KJCT-ND	PANASONIC	ERJ-2GE1102X	Yes	
29	1	R36	RESISTOR 120K OHM 1/20W 1% 0201 SMD	P12.0KABCT-ND	PANASONIC	ERJ-TGEF1202ZC	Yes	
30	1	R37	RESISTOR 330 OHM 1/16W 1% 0402 SMD	311-330LRCT-ND	YAGEO	RC0402FR-07330RL	Yes	
31	1	SW1	SWITCH TACTILE 6MM EXTEND ACT 160GF	EG1861-ND	E-SWITCH	TL1105SPF160Q	Yes	
32	2	SW2 SW3	SWITCH SLIDE SPDT SMD GULL	563-1022-1-ND	COPAL ELECTRONICS	CJS-1200TB	Yes	
33	2	TP1 TP6	TEST POINT LOOP COMPACT BLACK	5006K-ND	KEYSTONE		5006	Yes
34	2	TP2 TP3	TEST POINT LOOP COMPACT ORANGE	5008K-ND	KEYSTONE		5008	Yes
35	2	TP4 TP5	TEST POINT LOOP COMPACT ORANGE	5015KCT-ND	KEYSTONE		5015	Yes
36	2	U1 U2	IC 200MA LDO LINEAR REG SOT23-6	295-15305-1-ND	TEXAS INSTRUMENTS	TPS79301DBVRQ1	Yes	
37	1	U3	USB3803, 25VFBGA	576-2137-ND	MICREL	USB3803	Yes	
38	1	U4	POWER SWITCH USB MIC2026-1B	295-1092-1-ND	TEXAS INSTRUMENTS	MIC2026-1YM	Yes	
39	1	U5	IC SCHMITT-TRG INV GATE SOT23-5	295-1092-1-ND	TEXAS INSTRUMENTS	SN74AHC1G14DBVR	Yes	
40	1	Y1	OSCILLATOR PROG 3.3V +/-50PPM SMD	AP3535EC-ND	ABRACON	AP35-26.0MHz	Yes	

Figure 6.1 USB3803 EVB Bill of Materials

7 Revision History

Table 7.1 Customer Revision History

REVISION LEVEL & DATE	SECTION/FIGURE/ENTRY	CORRECTION
Rev 1.0 (12-07-12)	Initial Release	