

# Ultrahigh Speed Operational Amplifier

## FEATURES

- Gain Bandwidth Product,  $A_V = 1$ : 50MHz
- Slew Rate: 450V/ $\mu$ s
- Low Cost
- Output Current:  $\pm$ 50mA
- Settling Time: 140ns to 0.1%
- Differential Gain Error: 0.1%, ( $R_L = 1k$ )
- Differential Phase Error:  $0.06^\circ$ , ( $R_L = 1k$ )
- High Open-Loop Gain: 10V/mV Min
- Single Supply 5V Operation
- Output Shutdown

## APPLICATIONS

- Video Cable Drivers
- Video Signal Processing
- Fast Integrators
- Pulse Amplifiers
- D/A Current to Voltage Conversion

## DESCRIPTION

The LT<sup>®</sup>1190 is a video operational amplifier optimized for operation on  $\pm$ 5V, and a single 5V supply. Unlike many high speed amplifiers, this amplifier features high open-loop gain, over 85dB, and the ability to drive heavy loads to a full-power bandwidth of 20MHz at 7V<sub>p-p</sub>. In addition to its very fast slew rate, the LT1190 features a unity-gain-stable bandwidth of 50MHz and a 75° phase margin, making it extremely easy to use.

Because the LT1190 is a true operational amplifier, it is an ideal choice for wideband signal conditioning, fast integrators, active filters, and applications requiring speed, accuracy and low cost.

The LT1190 is available in 8-pin PDIP and SO packages with standard pinouts. The normally unused Pin 5 is used for a shutdown feature that shuts off the output and reduces power dissipation to a mere 15mW.

 LTC and LT are registered trademarks of Linear Technology Corporation.

## TYPICAL APPLICATION

Video MUX Cable Driver

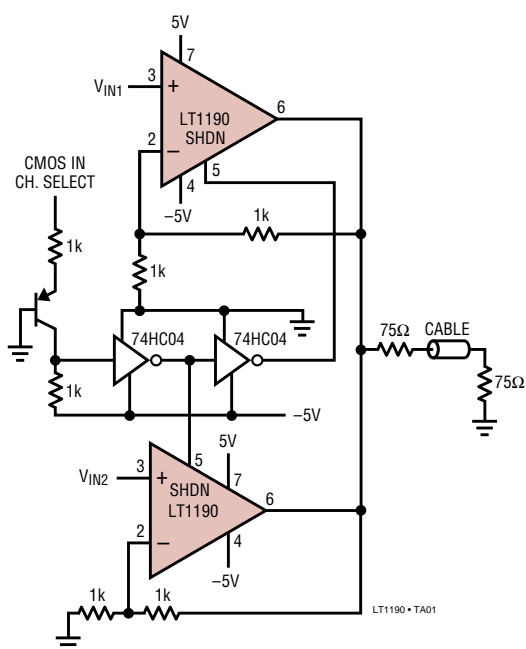

Inverter Pulse Response

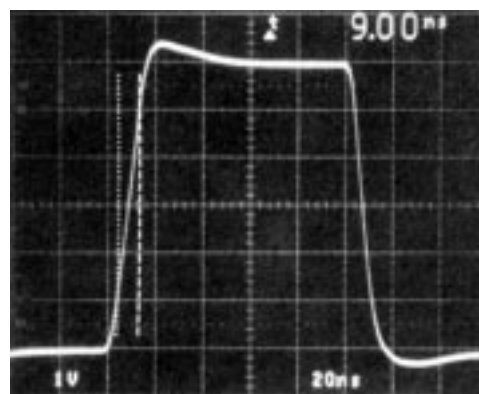

$A_V = -1$ ,  $C_L = 10pF$  SCOPE PROBE

1190 TA02

**ABSOLUTE MAXIMUM RATINGS**

(Note 1)

Total Supply Voltage ( $V^+$ to $V^-$ ) .....	18V
Differential Input Voltage .....	$\pm 6V$
Input Voltage .....	$\pm V_S$
Output Short-Circuit Duration (Note 2) .....	Continuous
Maximum Junction Temperature .....	150°C
Operating Temperature Range	
LT1190M ( <b>OBSOLETE</b> ) .....	-55°C to 125°C
LT1190C .....	0°C to 70°C
Storage Temperature Range .....	-65°C to 150°C
Lead Temperature (Soldering, 10 sec) .....	300°C

**PACKAGE/ORDER INFORMATION**

<p>TOP VIEW</p> <p>BAL 1 8 BAL -IN 2 7 V+ +IN 3 6 OUT V- 4 5 SHDN</p> <p>N8 PACKAGE 8-LEAD PDIP      S8 PACKAGE 8-LEAD PLASTIC SO</p> <p><math>T_{JMAX} = 150^\circ\text{C}</math>, <math>\theta_{JA} = 100^\circ\text{C/W}</math> (N8) <math>T_{JMAX} = 150^\circ\text{C}</math>, <math>\theta_{JA} = 150^\circ\text{C/W}</math> (S8)</p> <p>J8 PACKAGE 8-LEAD CERDIP <math>T_{JMAX} = 150^\circ\text{C}</math>, <math>\theta_{JA} = 100^\circ\text{C/W}</math></p> <p><b>OBSOLETE PACKAGE</b> Consider the N8 or S8 Packages for Alternate Source</p>	ORDER PART NUMBER
	LT1190CN8 LT1190CS8
	S8 PART MARKING
	1190
	LT1190MJ8 LT1190CJ8

Consult LTC Marketing for parts specified with wider operating temperature ranges.

**ELECTRICAL CHARACTERISTICS**

$V_S = \pm 5V$ ,  $T_A = 25^\circ\text{C}$ ,  $C_L \leq 10\text{pF}$ , Pin 5 open circuit unless otherwise noted.

SYMBOL	PARAMETER	CONDITIONS	LT1190M/C			UNITS
			MIN	TYP	MAX	
$V_{OS}$	Input Offset Voltage	N8 Package		3	10	mV
		SO-8 Package			15	mV
$I_{OS}$	Input Offset Current			0.2	1.7	$\mu\text{A}$
$I_B$	Input Bias Current			$\pm 0.5$	$\pm 2.5$	$\mu\text{A}$
$e_n$	Input Noise Voltage	$f_0 = 10\text{kHz}$		50		$\text{nV}/\sqrt{\text{Hz}}$
$i_n$	Input Noise Current	$f_0 = 10\text{kHz}$		4		$\text{pA}/\sqrt{\text{Hz}}$
$R_{IN}$	Input Resistance	Differential Mode		130		$\text{k}\Omega$
		Common Mode		5		$\text{M}\Omega$
$C_{IN}$	Input Capacitance	$A_V = 1$		2.2		pF
	Input Voltage Range	(Note 3)	-2.5		3.5	V
CMRR	Common Mode Rejection Ratio	$V_{CM} = -2.5V$ to $3.5V$	60	70		dB
PSRR	Power Supply Rejection Ratio	$V_S = \pm 2.375V$ to $\pm 8V$	60	70		dB
$A_{VOL}$	Large-Signal Voltage Gain	$R_L = 1\text{k}$ , $V_0 = \pm 3V$	10	22		$\text{V}/\text{mV}$
		$R_L = 100\Omega$ , $V_0 = \pm 3V$	2.5	6		$\text{V}/\text{mV}$
		$V_S = \pm 8V$ , $R_L = 100\Omega$ , $V_0 = \pm 5V$	3.5	12		$\text{V}/\text{mV}$
$V_{OUT}$	Output Voltage Swing	$V_S = \pm 5V$ , $R_L = 1\text{k}$	$\pm 3.7$	$\pm 4$		V
		$V_S = \pm 8V$ , $R_L = 1\text{k}$	$\pm 6.7$	$\pm 7$		V
SR	Slew Rate	$A_V = -1$ , $R_L = 1\text{k}$ (Notes 4, 9)	325	450		$\text{V}/\mu\text{s}$
FPBW	Full-Power Bandwidth	$V_0 = 6V_{P-P}$ (Note 5)	17.2	23.9		MHz
GBW	Gain Bandwidth Product			50		MHz
$t_{r1}$ , $t_{f1}$	Rise Time, Fall Time	$A_V = 50$ , $V_0 = \pm 1.5V$ , 20% to 80%, (Note 9)	175	250	325	ns
$t_{r2}$ , $t_{f2}$	Rise Time, Fall Time	$A_V = 1$ , $V_0 = \pm 125\text{mV}$ , 10% to 90%		1.9		ns
$t_{PD}$	Propagation Delay	$A_V = 1$ , $V_0 = \pm 125\text{mV}$ , 50% to 50%		2.4		ns
	Overshoot	$A_V = 1$ , $V_0 = \pm 125\text{mV}$		5		%
$t_s$	Settling Time	3V Step, 0.1% (Note 6)		140		ns

**ELECTRICAL CHARACTERISTICS**  $V_S = \pm 5V$ ,  $T_A = 25^\circ C$ ,  $C_L \leq 10pF$ , Pin 5 open circuit unless otherwise noted.

SYMBOL	PARAMETER	CONDITIONS	LT1190M/C			UNITS
			MIN	TYP	MAX	
Diff $A_V$	Differential Gain	$R_L = 150\Omega$ , $A_V = 2$ (Note 7)		0.35		%
Diff Ph	Differential Phase	$R_L = 150\Omega$ , $A_V = 2$ (Note 7)		0.16		Deg <sub>p-p</sub>
$I_S$	Supply Current			32	38	mA
	Shutdown Supply Current	Pin 5 at $V^-$		1.3	2	mA
$I_{SHDN}$	Shutdown Pin Current	Pin 5 at $V^-$		20	50	$\mu A$
$t_{ON}$	Turn On Time	Pin 5 from $V^-$ to Ground, $R_L = 1k$		100		ns
$t_{OFF}$	Turn Off Time	Pin 5 from Ground to $V^-$ , $R_L = 1k$		400		ns

$V_S^+ = 5V$ ,  $V_S^- = 0V$ ,  $V_{CM} = 2.5V$ ,  $T_A = 25^\circ C$ ,  $C_L \leq 10pF$ , Pin 5 open circuit unless otherwise noted.

SYMBOL	PARAMETER	CONDITIONS	LT1190M/C			UNITS
			MIN	TYP	MAX	
$V_{OS}$	Input Offset Voltage	N8 Package		3	11	mV
		SO-8 Package			15	mV
$I_{OS}$	Input Offset Current			0.2	1.2	$\mu A$
$I_B$	Input Bias Current			$\pm 0.5$	$\pm 1.5$	$\mu A$
	Input Voltage Range	(Note 3)	2		3.5	V
CMRR	Common Mode Rejection Ratio	$V_{CM} = 2V$ to $3.5V$	55	70		dB
$A_{VOL}$	Large-Signal Voltage Gain	$R_L = 100\Omega$ to Ground, $V_O = 1V$ to $3V$	2.5	7		V/mV
$V_{OUT}$	Output Voltage Swing	$R_L = 100\Omega$ to Ground	$V_{OUT}$ High	3.6	3.8	V
			$V_{OUT}$ Low		0.25	0.4
SR	Slew Rate	$A_V = -1$ , $V_O = 1V$ to $3V$		250		V/ $\mu s$
GBW	Gain Bandwidth Product			47		MHz
$I_S$	Supply Current		24.5	29	36	mA
	Shutdown Supply Current	Pin 5 at $V^-$		1.2	2	mA
$I_{SHDN}$	Shutdown Pin Current	Pin 5 at $V^-$		20	50	$\mu A$

The ● denotes the specifications which apply over the full operating temperature range of  $-55^\circ C \leq T_A \leq 125^\circ C$ .  $V_S = \pm 5V$ , Pin 5 open circuit unless otherwise noted.

SYMBOL	PARAMETER	CONDITIONS	LT1190M			UNITS
			MIN	TYP	MAX	
$V_{OS}$	Input Offset Voltage	N8 Package	●	5	14	mV
$\Delta V_{OS}/\Delta T$	Input $V_{OS}$ Drift		●	16		$\mu V/^\circ C$
$I_{OS}$	Input Offset Current		●	0.2	2	$\mu A$
$I_B$	Input Bias Current		●	$\pm 0.5$	$\pm 2.5$	$\mu A$
CMRR	Common Mode Rejection Ratio	$V_{CM} = -2.5V$ to $3.5V$	●	55	70	dB
PSRR	Power Supply Rejection Ratio	$V_S = \pm 2.375V$ to $\pm 5V$	●	55	70	dB
$A_{VOL}$	Large-Signal Voltage Gain	$R_L = 1k$ , $V_O = \pm 3V$	●	8	16	V/mV
		$R_L = 100\Omega$ , $V_O = \pm 3V$	●	1	2.5	V/mV
$V_{OUT}$	Output Voltage Swing	$R_L = 1k$	●	$\pm 3.7$	$\pm 3.9$	V
$I_S$	Supply Current		●	32	38	mA
	Shutdown Supply Current	Pin 5 at $V^-$ (Note 8)	●	1.5	2.5	mA
$I_{SHDN}$	Shutdown Pin Current	Pin 5 at $V^-$	●	20		$\mu A$

**ELECTRICAL CHARACTERISTICS** The ● denotes the specifications which apply over the full operating temperature range of  $0^{\circ}\text{C} \leq T_A \leq 70^{\circ}\text{C}$ .  $V_S = \pm 5\text{V}$ , Pin 5 open circuit unless otherwise noted.

SYMBOL	PARAMETER	CONDITIONS	LT1190C			UNITS
			MIN	TYP	MAX	
$V_{OS}$	Input Offset Voltage	N8 Package	●	3	11	mV
		SO-8 Package			18	mV
$\Delta V_{OS}/\Delta T$	Input $V_{OS}$ Drift		●	16		$\mu\text{V}/^{\circ}\text{C}$
$I_{OS}$	Input Offset Current		●	0.2	1.7	$\mu\text{A}$
$I_B$	Input Bias Current		●	$\pm 0.5$	$\pm 2.5$	$\mu\text{A}$
CMRR	Common Mode Rejection Ratio	$V_{CM} = -2.5\text{V to } 3.5\text{V}$	●	58	70	dB
PSRR	Power Supply Rejection Ratio	$V_S = \pm 2.375\text{V to } \pm 5\text{V}$	●	58	70	dB
$A_{VOL}$	Large-Signal Voltage Gain	$R_L = 1\text{k}, V_O = \pm 3\text{V}$	●	9	20	V/mV
		$R_L = 100\Omega, V_O = \pm 3\text{V}$	●	2	6	V/mV
$V_{OUT}$	Output Voltage Swing	$R_L = 1\text{k}$	●	$\pm 3.7$	$\pm 3.9$	V
$I_S$	Supply Current		●	32	38	mA
	Shutdown Supply Current	Pin 5 at $V^-$ (Note 8)	●	1.4	2.1	mA
$I_{SHDN}$	Shutdown Pin Current	Pin 5 at $V^-$	●	20		$\mu\text{A}$

**Note 1:** Absolute maximum ratings are those values beyond which the life of the device may be impaired.

**Note 2:** A heat sink is required to keep the junction temperature below absolute maximum when the output is shorted.

**Note 3:** Exceeding the input common mode range may cause the output to invert.

**Note 4:** Slew rate is measured between  $\pm 1\text{V}$  on the output, with a  $\pm 3\text{V}$  input step.

**Note 5:** Full-power bandwidth is calculated from the slew rate measurement:

$$FPBW = SR/2\pi V_P$$

**Note 6:** Settling time measurement techniques are shown in "Take the Guesswork Out of Settling Time Measurements," EDN, September 19, 1985.  $A_V = -1$ ,  $R_L = 1\text{k}$ .

**Note 7:** NTSC (3.58MHz). For  $R_L = 1\text{k}$ , Diff  $A_V = 0.1\%$ , Diff  $Ph = 0.06^{\circ}$ .

**Note 8:** See Applications section for shutdown at elevated temperatures. Do not operate the shutdown above  $T_J > 125^{\circ}\text{C}$ .

**Note 9:** AC parameters are 100% tested on the ceramic and plastic DIP packaged parts (J and N suffix) and are sample tested on every lot of the SO packaged parts (S suffix).

**Optional Offset Nulling Circuit**

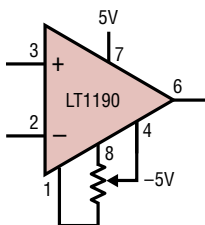

INPUT OFFSET VOLTAGE CAN BE ADJUSTED OVER A  $\pm 150\text{mV}$  RANGE WITH A  $1\text{k}\Omega$  TO  $10\text{k}\Omega$  POTENTIOMETER

LT1190 • TA03

# TYPICAL PERFORMANCE CHARACTERISTICS

**Input Bias Current vs Common Mode Voltage**

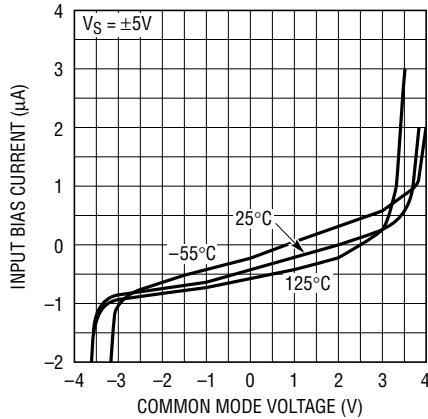

LT1190 • TPC01

**Input Bias Current vs Temperature**

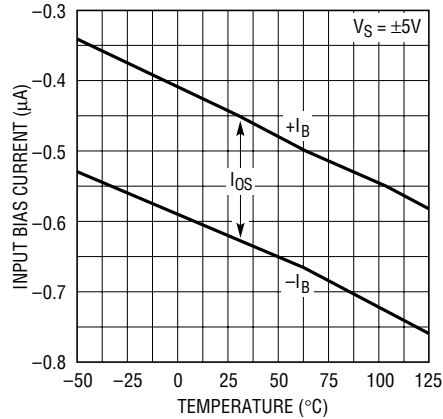

LT1190 • TPC02

**Common Mode Voltage vs Supply Voltage**

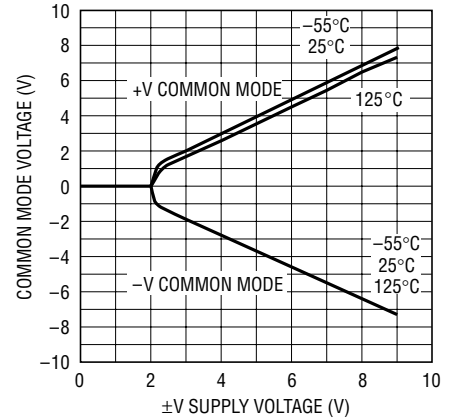

LT1190 • TPC03

**Equivalent Input Noise Voltage vs Frequency**

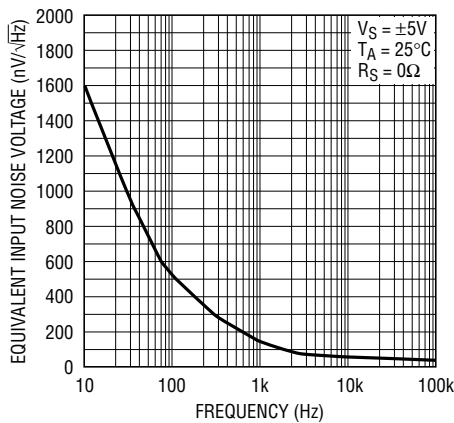

LT1190 • TPC04

**Equivalent Input Noise Current vs Frequency**

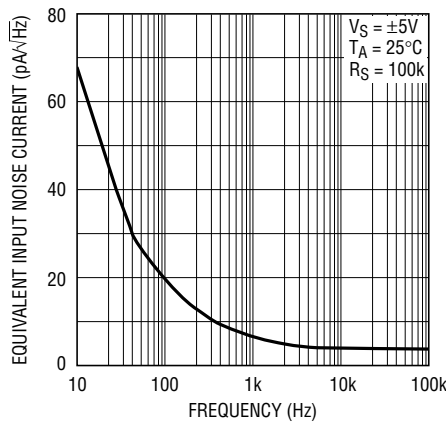

LT1190 • TPC05

**Supply Current vs Supply Voltage**

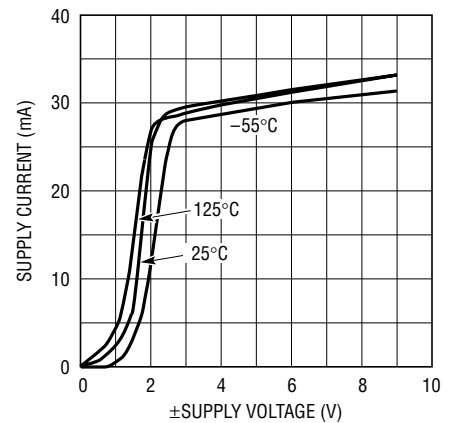

LT1190 • TPC06

**Shutdown Supply Current vs Temperature**

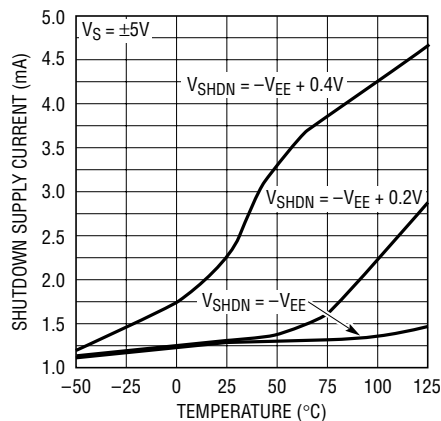

LT1190 • TPC07

**Open-Loop Voltage Gain vs Temperature**

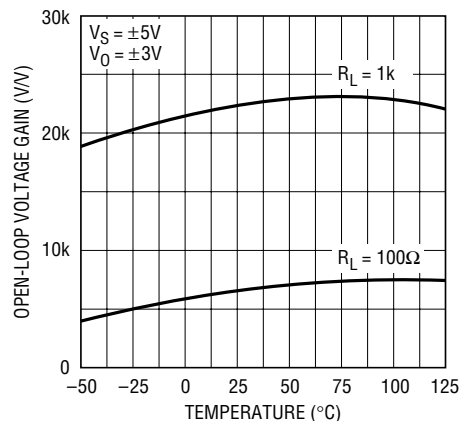

LT1190 • TPC08

**Open-Loop Voltage Gain vs Load Resistance**

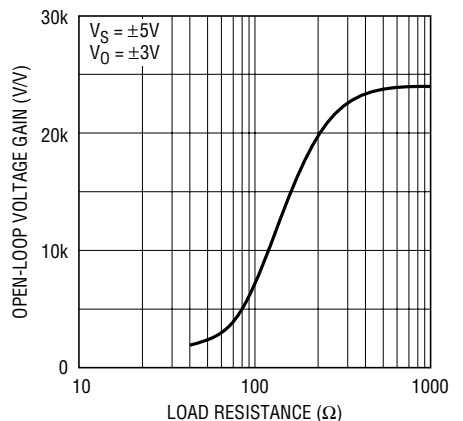

LT1190 • TPC09

# TYPICAL PERFORMANCE CHARACTERISTICS

**Gain, Phase vs Frequency**

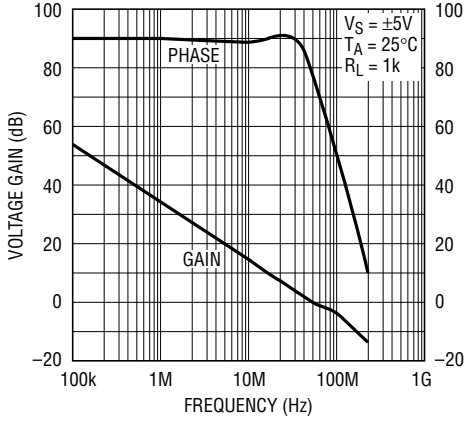

LT1190 • TPC10

**Gain Bandwidth Product vs Supply Voltage**

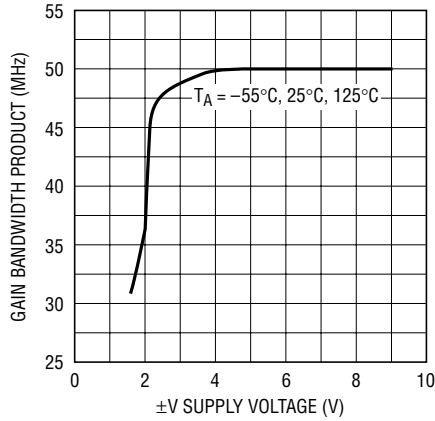

LT1190 • TPC11

**Output Impedance vs Frequency**

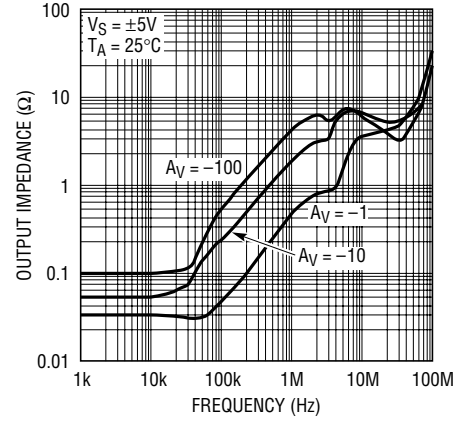

LT1190 • TPC12

**Unity Gain Frequency and Phase Margin vs Temperature**

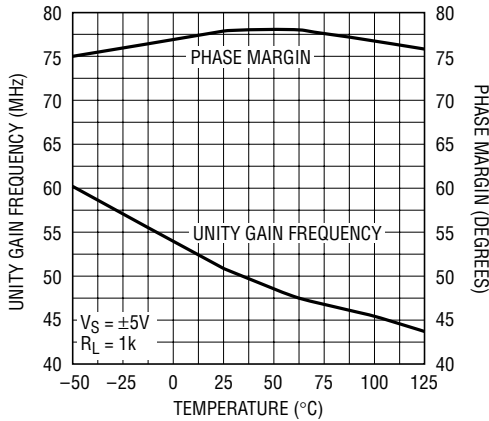

LT1190 • TPC13

**Common Mode Rejection Ratio vs Frequency**

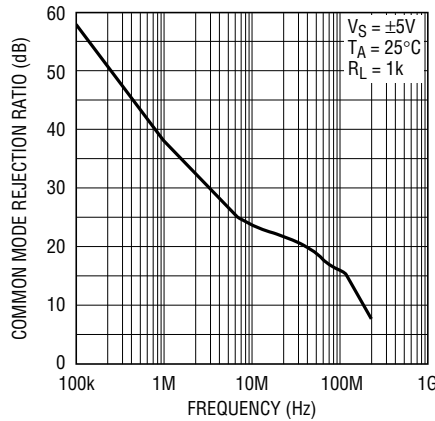

LT1190 • TPC14

**Power Supply Rejection Ratio vs Frequency**

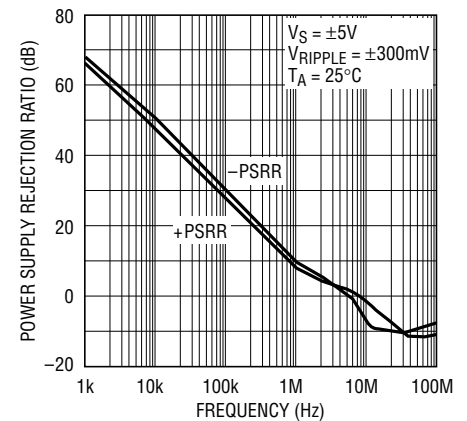

LT1190 • TPC15

**Output Short-Circuit Current vs Temperature**

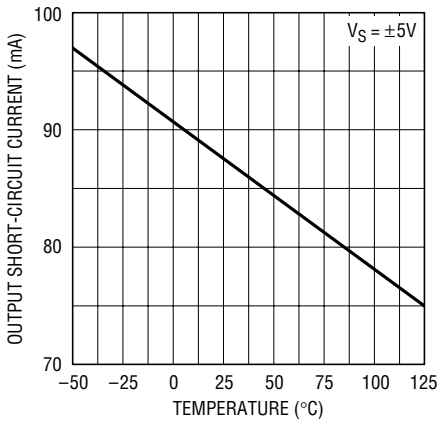

LT1190 • TPC16

**Output Swing vs Supply Voltage**

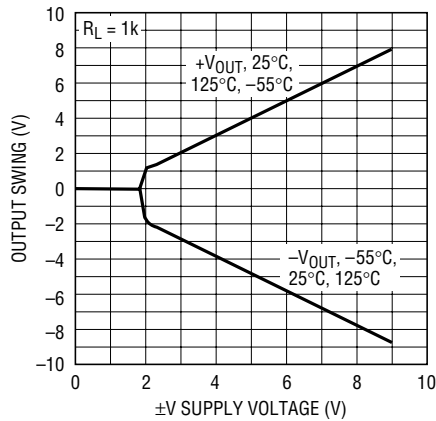

LT1190 • TPC17

**Output Voltage Swing vs Load Resistance**

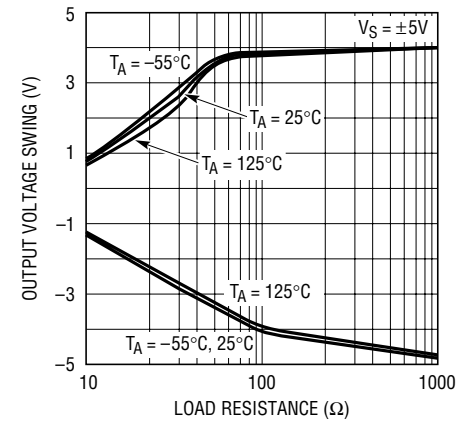

LT1190 • TPC18

# TYPICAL PERFORMANCE CHARACTERISTICS

**Slew Rate vs Temperature**

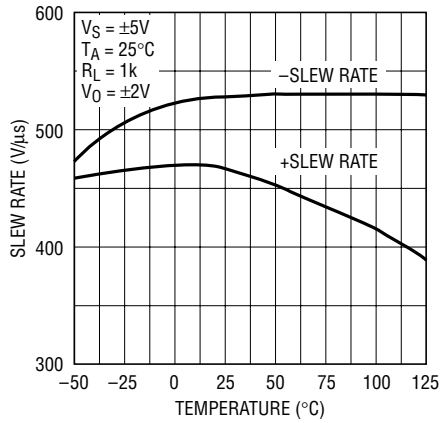

LT1190 • TPC19

**Output Voltage Step vs Settling Time,  $A_V = -1$**

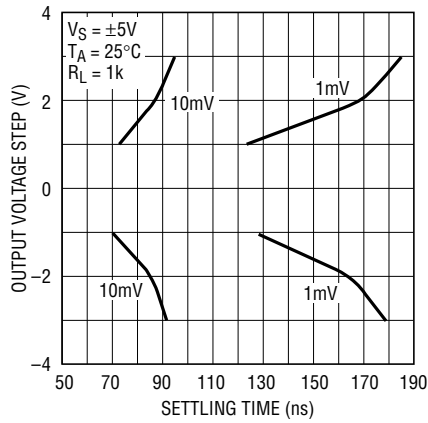

LT1190 • TPC20

**Output Voltage Step vs Settling Time,  $A_V = +1$**

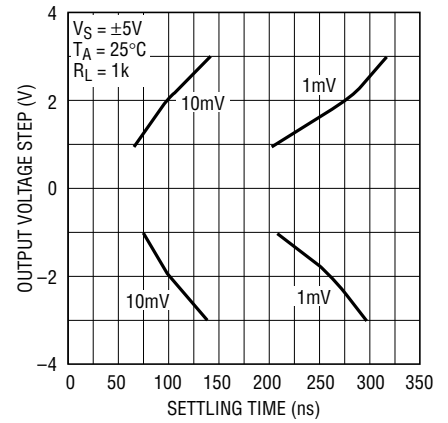

LT1190 • TPC21

**Large-Signal Transient Response**

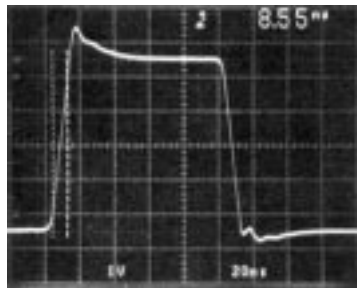

$A_V = +1$ ,  $C_L = 10pF$  SCOPE PROBE 1190 G22

**Small-Signal Transient Response**

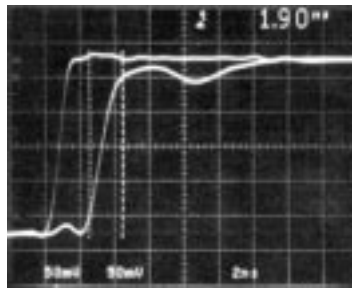

$A_V = +1$ , SMALL-SIGNAL RISE TIME, WITH FET PROBES 1190 G23

**Output Overload**

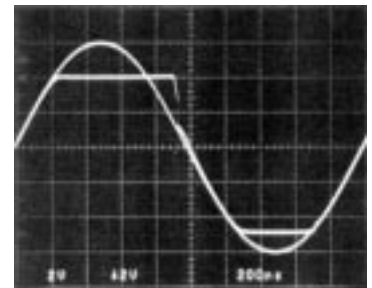

$A_V = -1$ ,  $V_{IN} = 12V_{p-p}$  1190 G24

## APPLICATIONS INFORMATION

### Power Supply Bypassing

The LT1190 is quite tolerant of power supply bypassing. In some applications a 0.1 $\mu$ F ceramic disc capacitor placed 1/2 inch from the amplifier is all that is required. A scope photo of the amplifier output with no supply bypassing is used to demonstrate this bypassing tolerance,  $R_L = 1k\Omega$ .

No Supply Bypass Capacitors

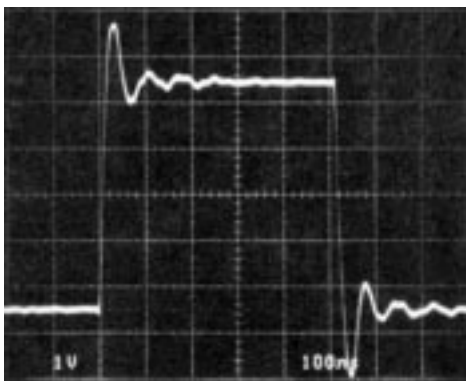

$A_V = -1$ , IN DEMO BOARD,  $R_L = 1k\Omega$

Supply bypassing can also affect the response in the frequency domain. It is possible to see a slight 1dB rise in the frequency response at 130MHz depending on the gain configuration, supply bypass, inductance in the supply leads and printed circuit board layout. This can be further minimized by not using a socket.

Closed-Loop Voltage Gain vs Frequency

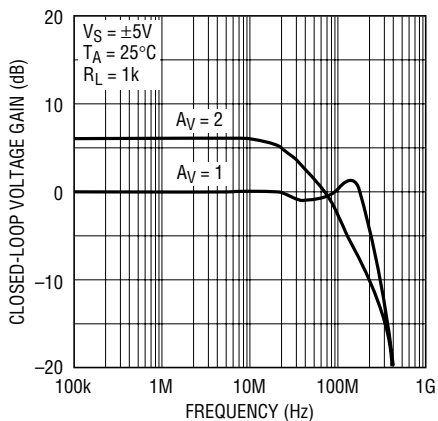

LT1190 • TA05

In most applications, and those requiring good settling time, it is important to use multiple bypass capacitors. A 0.1 $\mu$ F ceramic disc in parallel with a 4.7 $\mu$ F tantalum is recommended. Two oscilloscope photos with different bypass conditions are used to illustrate the settling time characteristics of the amplifier. Note that although the output waveform looks acceptable at 1V/DIV, when amplified to 1mV/DIV the settling time to 2mV is 4.244 $\mu$ s for the 0.1 $\mu$ F bypass; the time drops to 163ns with multiple bypass capacitors.

Settling Time Poor Bypass

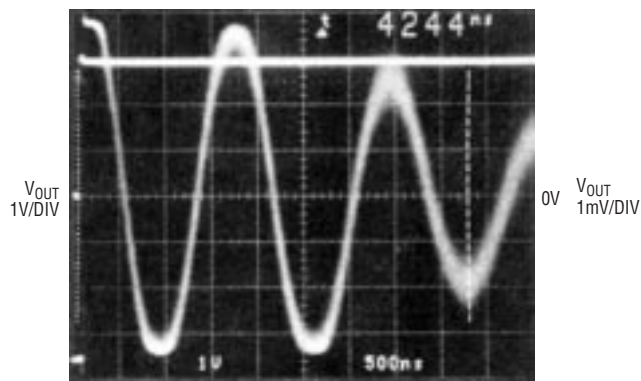

SETTLING TIME TO 2mV,  $A_V = -1$   
SUPPLY BYPASS CAPACITORS = 0.1 $\mu$ F

Settling Time Good Bypass

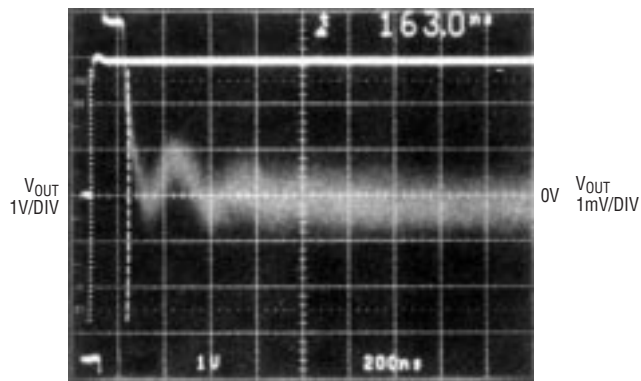

SETTLING TIME TO 2mV,  $A_V = -1$   
SUPPLY BYPASS CAPACITORS = 0.1 $\mu$ F + 4.7 $\mu$ F TANTALUM



# APPLICATIONS INFORMATION

## Cable Terminations

The LT1190 operational amplifier has been optimized as a low cost video cable driver. The  $\pm 50\text{mA}$  guaranteed output current enables the LT1190 to easily deliver  $7.5\text{V}_{\text{P-P}}$  into  $100\Omega$ , while operating on  $\pm 5\text{V}$  supplies or  $2.6\text{V}_{\text{P-P}}$  on a single  $5\text{V}$  supply.

### Double Terminated Cable Driver

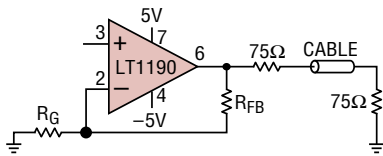

### Cable Driver Voltage Gain vs Frequency

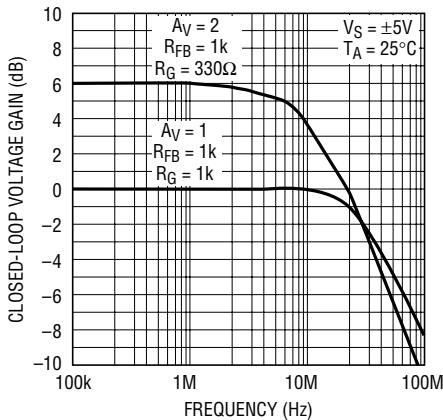

LT1190 • TA08

When driving a cable it is important to terminate the cable to avoid unwanted reflections. This can be done in one of two ways: single termination or double termination. With single termination, the cable must be terminated at the receiving end ( $75\Omega$  to ground) to absorb unwanted energy. The best performance can be obtained by double termination ( $75\Omega$  in series with the output of the amplifier, and  $75\Omega$  to ground at the other end of the cable). This termination is preferred because reflected energy is absorbed at each end of the cable. When using the double termination technique it is important to note that the signal is attenuated by a factor of 2, or 6dB. This can be compensated for by taking a gain of 2, or 6dB in the amplifier. The cable driver has a  $-3\text{dB}$  bandwidth in excess of  $30\text{MHz}$  while driving the  $150\Omega$  load.

## Using the Shutdown Feature

The LT1190 has a unique feature that allows the amplifier to be shut down for conserving power or for multiplexing several amplifiers onto a common cable. The amplifier will shut down by taking Pin 5 to  $V^-$ . In shutdown, the amplifier dissipates  $15\text{mW}$  while maintaining a true high impedance output state of  $15\text{k}\Omega$  in parallel with the feedback resistors. The amplifiers must be used in a noninverting configuration for MUX applications. In inverting configurations the input signal is fed to the output through the feedback components. The following scope photos show that with very high  $R_L$ , the output is truly high impedance; the output slowly decays toward ground. Additionally, when the output is loaded with as little as  $1\text{k}\Omega$  the amplifier shuts off in  $400\text{ns}$ . This shutoff can be under the control of HC CMOS operating between  $0\text{V}$  and  $-5\text{V}$ .

### Output Shutdown

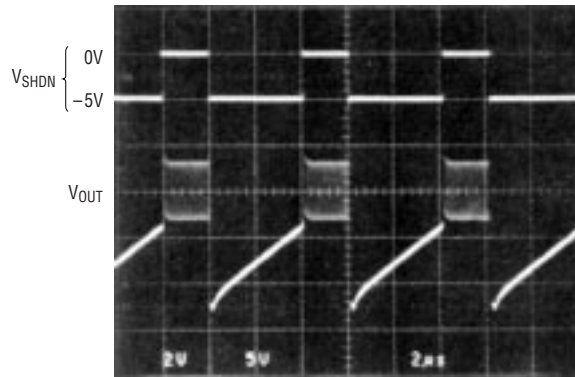

LT1190 • TA09

1MHz SINE WAVE GATED OFF WITH SHUTDOWN PIN,  $A_V = 1$ ,  $R_L = \text{SCOPE PROBE}$

### Output Shutdown

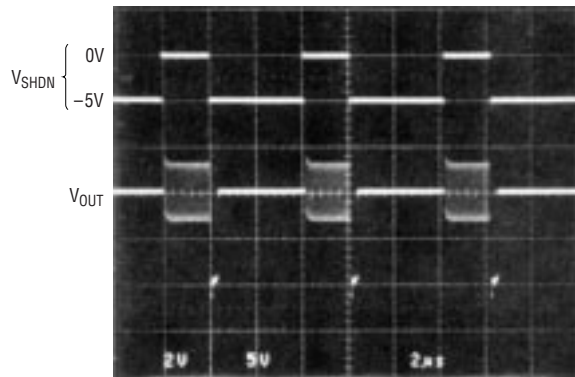

LT1190 • TA10

1MHz SINE WAVE GATED OFF WITH SHUTDOWN PIN,  $A_V = 1$ ,  $R_L = 1\text{k}\Omega$

## APPLICATIONS INFORMATION

The ability to maintain shutoff is shown on the curve Shutdown Supply Current vs Temperature in the Typical Performance Characteristics section. At very high elevated temperatures it is important to hold the shutdown pin close to the negative supply to keep the supply current from increasing.

### Murphy Circuits

There are several precautions the user should take when using the LT1190 in order to realize its full capability. Although the LT1190 can drive a 50pF load, isolating the capacitance with 10Ω can be helpful. Precautions primarily have to do with driving large capacitive loads.

Other precautions include:

1. Use a ground plane (see Design Note 50, High Frequency Amplifier Evaluation Board).
2. Do not use high source impedances. The input capacitance of 2pF and  $R_S = 10k$  for instance, will give an 8MHz -3dB bandwidth.
3. PC board socket may reduce stability.
4. A feedback resistor of 1k or lower reduces the effects of stray capacitance at the inverting input. (For instance, closed-loop gain of 2 can use  $R_{FB} = 300\Omega$  and  $R_G = 300\Omega$ .)

Driving Capacitive Load

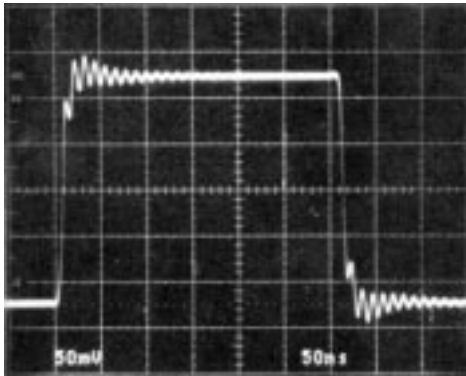

$A_V = -1$ , IN DEMO BOARD,  $C_L = 50pF$

LT1190 • TA11

Driving Capacitive Load

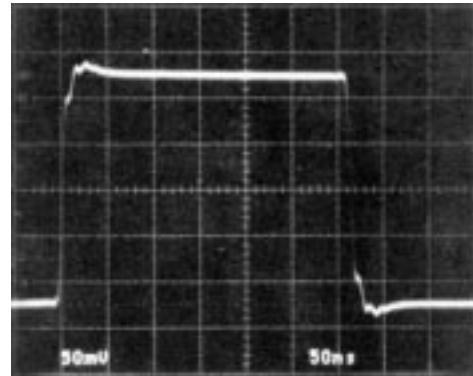

$A_V = -1$ , IN DEMO BOARD,  $C_L = 50pF$   
WITH 10Ω ISOLATING RESISTOR

LT1190 • TA12

### Murphy Circuits

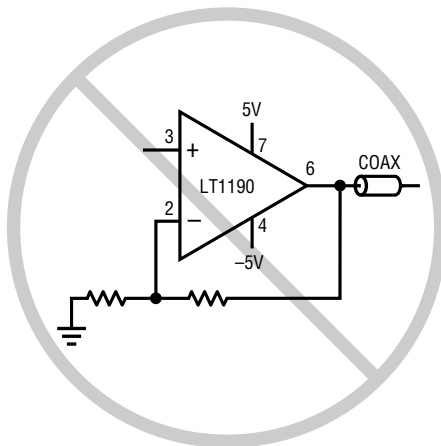

An unterminated cable is a large capacitive load

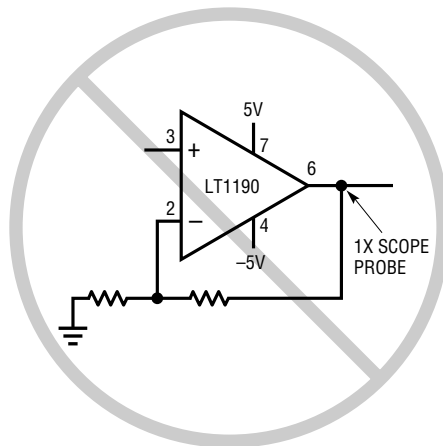

A 1X Scope Probe is a large capacitive load

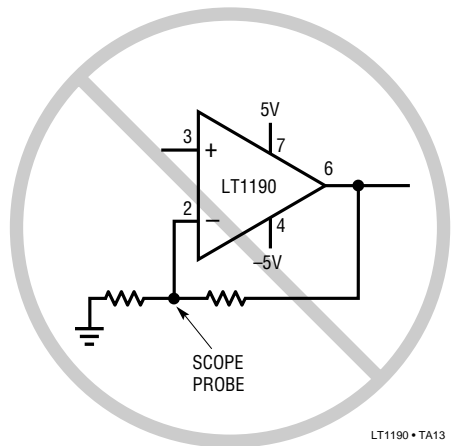

A Scope Probe on the Inverting Input Reduces Phase Margin

LT1190 • TA13

# SIMPLIFIED SCHEMATIC

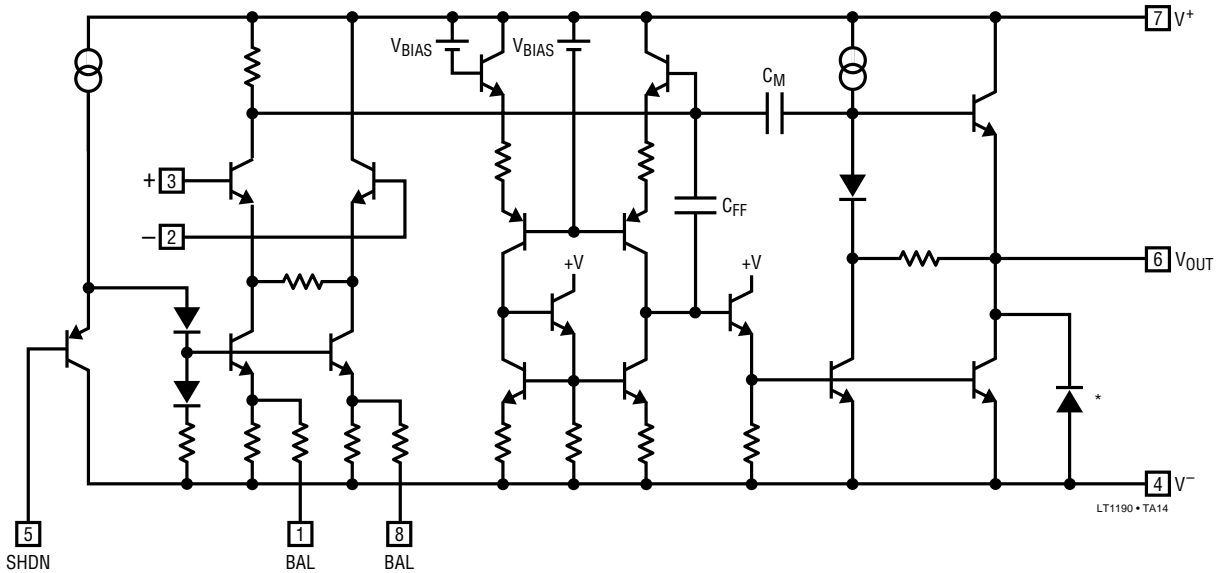

\*SUBSTRATE DIODE, DO NOT FORWARD BIAS

# PACKAGE DESCRIPTION Dimensions in inches (millimeters) unless otherwise noted.

**J8 Package**  
**8-Lead CERDIP (Narrow 0.300, Hermetic)**  
 (LTC DWG # 05-08-1110)

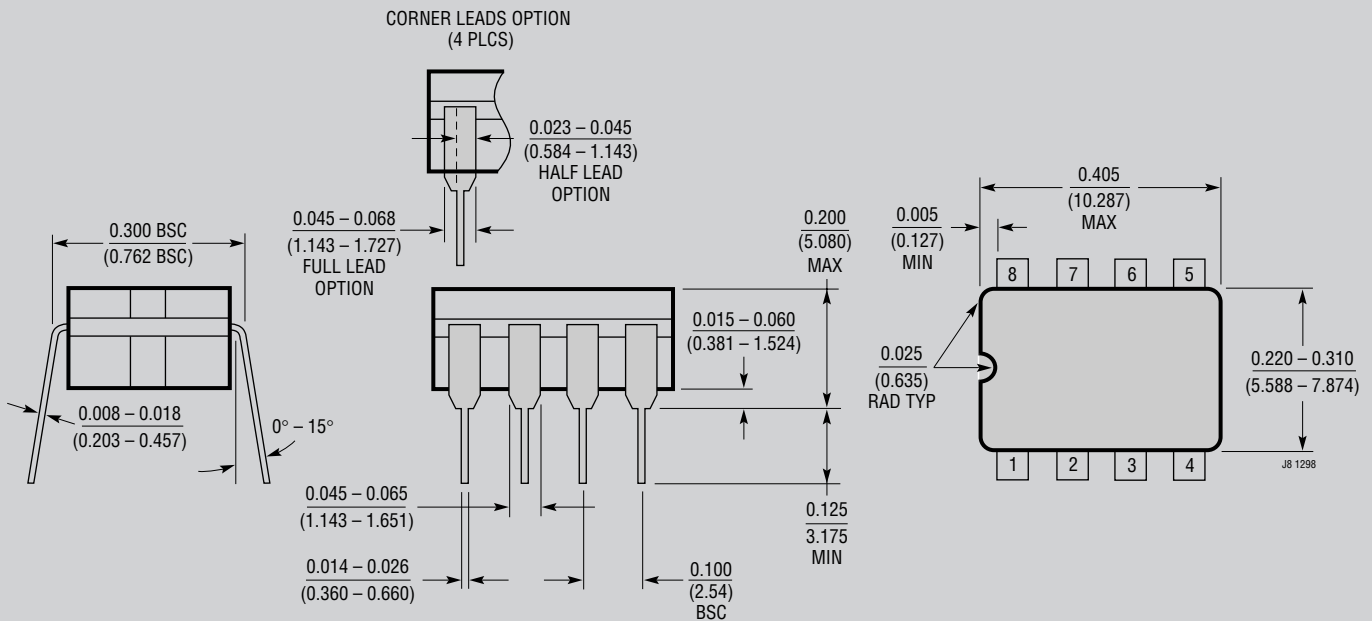

NOTE: LEAD DIMENSIONS APPLY TO SOLDER DIP/PLATE OR TIN PLATE LEADS

**OBSELETE PACKAGE**

# PACKAGE DESCRIPTION

## N8 Package 8-Lead PDIP (Narrow .300 Inch) (Reference LTC DWG # 05-08-1510)

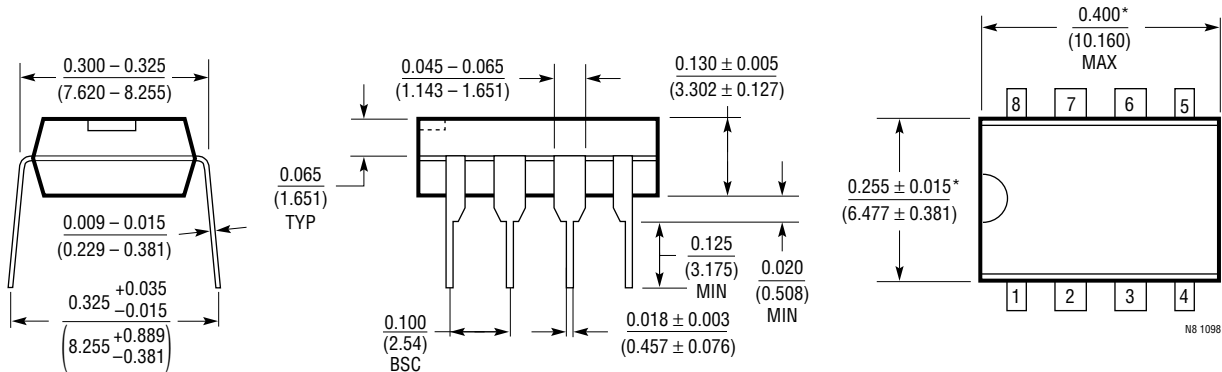

\*THESE DIMENSIONS DO NOT INCLUDE MOLD FLASH OR PROTRUSIONS.  
MOLD FLASH OR PROTRUSIONS SHALL NOT EXCEED 0.010 INCH (0.254mm)

## S8 Package 8-Lead Plastic Small Outline (Narrow .150 Inch) (Reference LTC DWG # 05-08-1610)

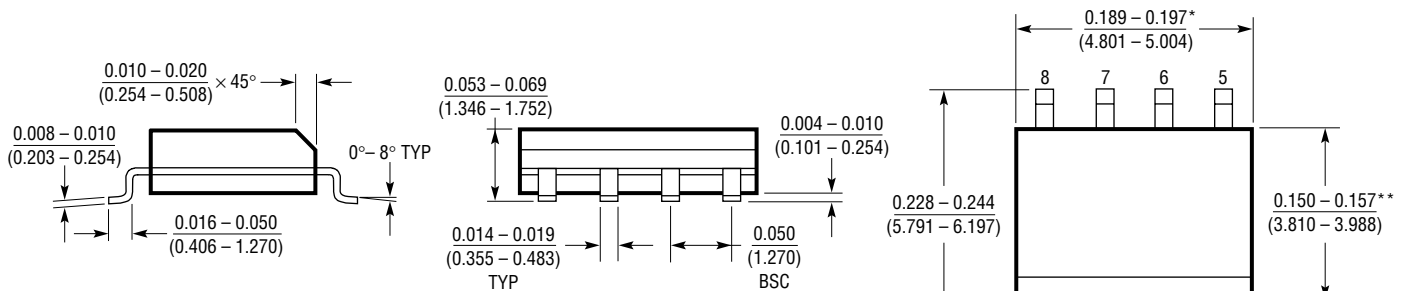

\*DIMENSION DOES NOT INCLUDE MOLD FLASH. MOLD FLASH SHALL NOT EXCEED 0.006\* (0.152mm) PER SIDE  
\*\*DIMENSION DOES NOT INCLUDE INTERLEAD FLASH. INTERLEAD FLASH SHALL NOT EXCEED 0.010\* (0.254mm) PER SIDE

## RELATED PARTS

PART NUMBER	DESCRIPTION	COMMENTS
LT1357	High Speed Operational Amplifier	50MHz Gain Bandwidth, 800V/μs Slew Rate, I <sub>S</sub> = 5mA Max
LT1360	High Speed Operational Amplifier	25MHz Gain Bandwidth, 600V/μs Slew Rate, I <sub>S</sub> = 2.5mA Max