

1- stage filter for 3-phase systems



Description

- 3 phase line filter with standard attenuation
- Available as high voltage filter (up to 520 VAC)

Standards

- IEC 60939
- UL 1283, edition 5 and CSA 22.2 No. 8-M1986 @ Ta 75°C for filter types with excellent attenuation up to 110A and high attenuation filter (L-) types. UL PENDING for filter types with excellent attenuation with rated current >110A and high voltage filter (-I) types.

Approvals

- VDE Certificate Number: 40004666 + 40004673
- UL File Number: E72928

Applications

- Voltage rating 480 and 520 VAC for world wide acceptance
- Protection against interference voltage from the mains
- For photovoltaic systems and industrial applications
- Suitable for use in equipment according to IEC/UL 60950

Weblinks

[pdf datasheet](#), [html-datasheet](#), [General Product Information](#), [Approvals](#), [CE declaration of conformity](#), [RoHS](#), [CHINA-RoHS](#), [REACH](#), [Distributor-Stock-Check](#), [Detailed request for product](#)

Technical Data

Rated Current	6 - 1100A	Mounting	Screw-on mounting on chassis, from top
Rated voltage	480/520 VAC, 50/60 Hz	Terminal	Screw clamps
Approval for	6 - 1100A @ Ta 40 (75) °C / 520 VAC; 50Hz	Operating Temperature	-25 °C to 100 °C
Overload Current	1.5 x Ir	Climatic Category	25/100/21 acc. to IEC 60068-1
Leakage Current	industrial < 15mA (440V / 50Hz)	Degree of Protection	IP 20 acc. to IEC 60529
Dielectric Strength	480VAC:	Protection Class	Suitable for appliances with protection class I acc. to IEC 61140
	2.25kVDC between L-L	MTBF	> 200'000h acc. to MIL-HB-217 F
	3kVDC between L-PE		
	520VAC:		
	2.25kVDC between L-L		
	4 kVDC between L-PE		
	Test voltage (2 sec)		
Number of Filter Stages	1-stage		
Weight	0.9 - 47 kg		
Material: Housing	Metal		
Sealing Compound	UL 94V-0		

Detailed information on product approvals, code requirements, usage instructions and detailed test conditions can be looked up in [General Product Information](#)

Dimension

Case 24-3

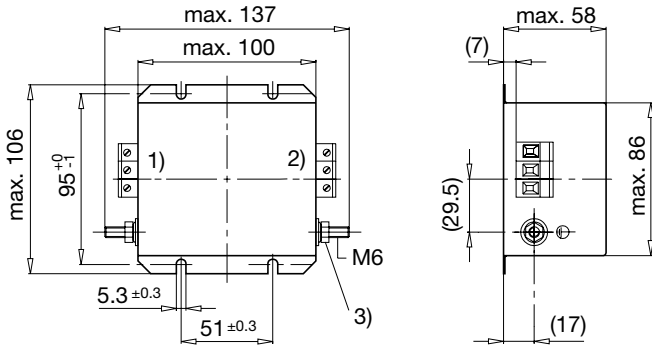

- 1) Line
- 2) Load
- 3) Nut torque 3...4 Nm

Case 32-3

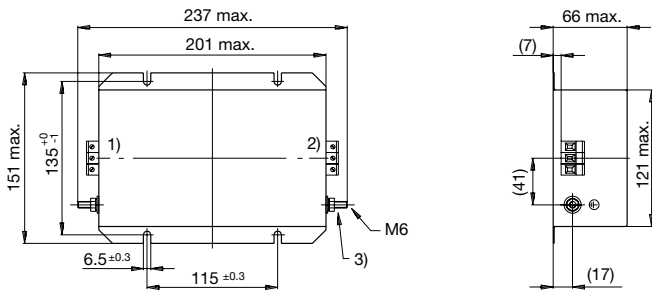

Case 32-C

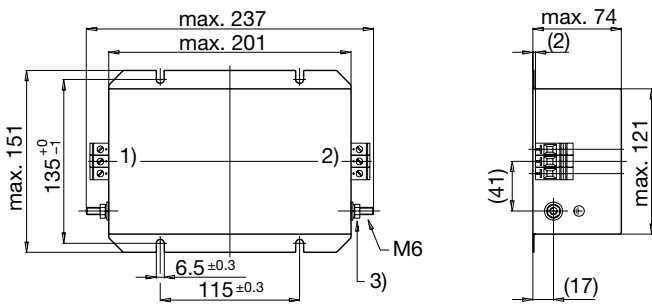

Case 31-3

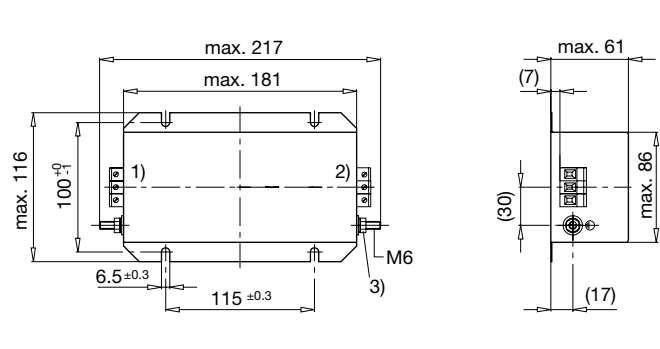

Case 32-7

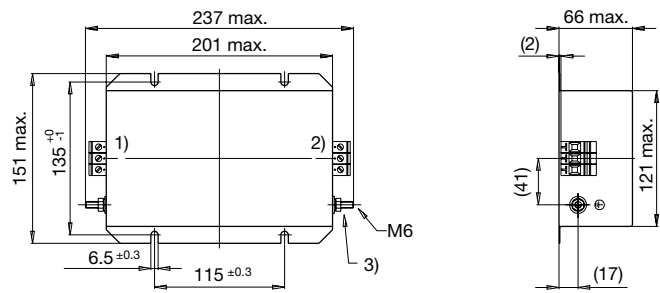

Case 34-3

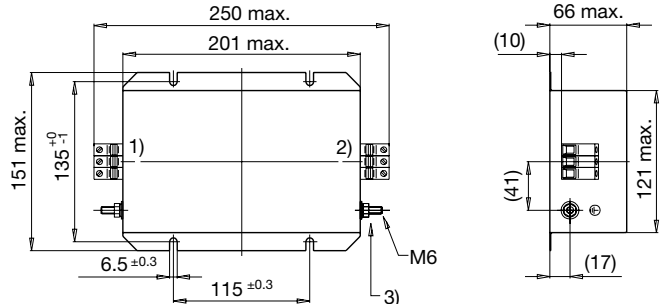

Case 34-C

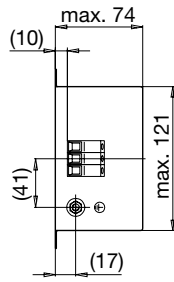
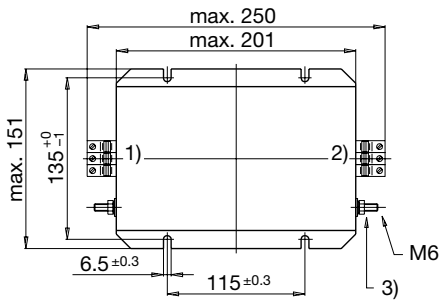

Case 37-3

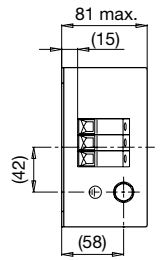
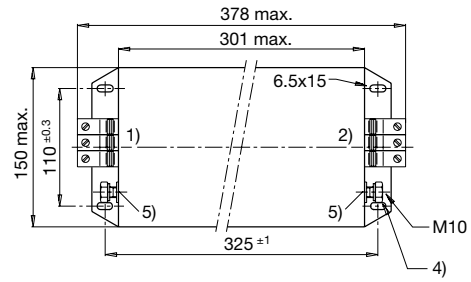

Case 53-3

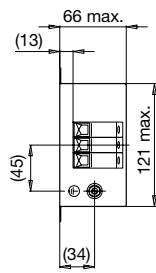
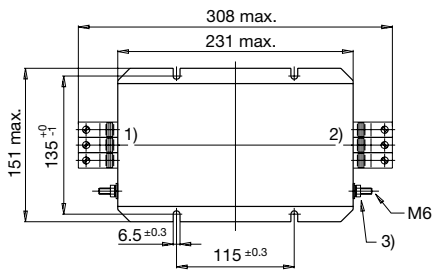

Case 54-3

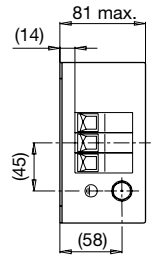
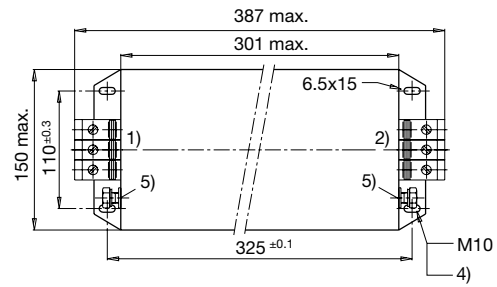

- 1) Line
- 2) Load
- 3) Tightening torque 3...4 Nm
- 4) Tightening torque 10...17 Nm
- 5) Do not unscrew lock-nut

Case 55-3

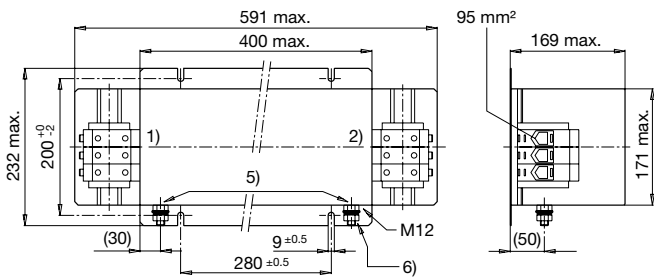

Case 56-3

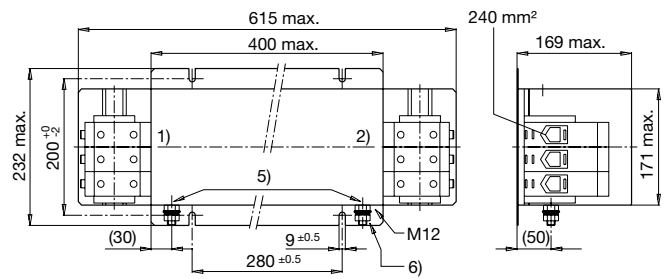

Case 57

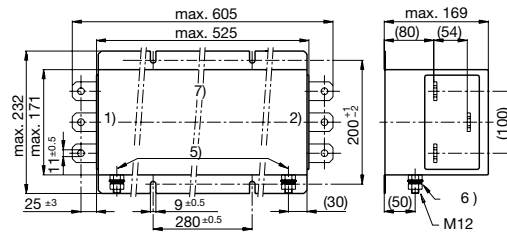

Case 74

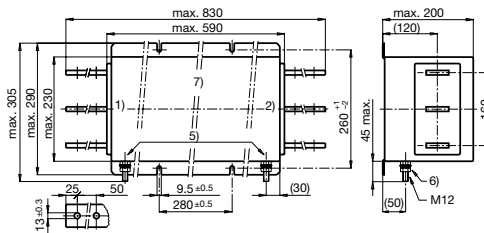

- 1) Line
- 2) Load
- 5) Do not unscrew lock-nut
- 6) Tightening torque 14...30 Nm
- 7) Current plates 720 mm² (60x12)

Technical data to the filter components

Rated Current @ Ta 40°C (75°C)	Characteristic	Rated Voltage [VAC]	L [mH]	C1 [µF]	C2 [µF]	C3 [nF]	C4 [nF]	C5 [µF]	C6 [µF]	R1 [MΩ]	R2 [MΩ]	R3 [MΩ]	R4 [MΩ]
6 (6)	Excellent attenuation	-	10	1.0	-	100	10	2.2	-	-	-	1	1
8 (5)	Excellent attenuation	480	10	1.0	-	100	10	2.2	-	-	-	1	1
16 (10)	Excellent attenuation	480	6	1.0	-	100	10	2.2	-	-	-	1	1
16 (Pending)	High voltage filter	520	6	1.5	-	50	11	1.5	-	2	1	1	2
16 (10)	Excellent attenuation	-	6	1.0	-	100	10	2.2	-	-	-	1	1
25 (15)	Excellent attenuation	-	3	4.4	1	10	47	4.4	1	2.2	1	1	2.2
25 (14)	High attenuation	-	2.4	4.4	1	10	47	4.4	1	2.2	-	1	2
25 (Pending)	High voltage filter	520	3	3	1.1	50	11	3	1.1	2	1	1	2
36 (20)	High attenuation	-	1.5	4.4	1	10	47	4.4	1	2.2	-	1	2
36 (Pending)	High voltage filter	520	2	3	1.1	50	11	3	1.1	2	1	1	2
50 (32)	Excellent attenuation	-	1	4.4	1	10	100	4.4	1	2.2	1	1	2.2
50 (30)	High attenuation	-	1	4.4	1	10	100	4.4	1	2.2	-	1	2
50 (Pending)	High voltage filter	520	1	3	1.1	50	11	3	1.1	2	1	1	2
64 (37)	High attenuation	-	0.6	4.4	1	10	100	4.4	1	2.2	-	1	2
80 (45)	Excellent attenuation	-	1	6.6	1	47	100	6.6	1	2.2	1	1	2.2
80 (Pending)	High voltage filter	520	1	4.5	1.1	50	50	4.5	1.1	2	1	1	2
64 (37)	Excellent attenuation	480	0.6	4.4	1	10	100	4.4	1	2.2	1	1	2.2
64 (Pending)	High voltage filter	520	0.6	3	1.1	50	11	3	1.1	2	1	1	2
110 (70)	Excellent attenuation	-	0.7	6.6	1	47	100	6.6	1	2.2	1	1	2.2
110 (Pending)	High voltage filter	520	0.7	4.5	1.1	50	50	4.5	1.1	2	1	1	2
180 (Pending)	Excellent attenuation	-	0.4	6.6	1	47	100	6.6	1	2.2	1	1	2.2
180 (Pending)	High voltage filter	520	0.4	4.5	1.1	50	50	4.5	1.1	2	1	1	2
250 (Pending)	Excellent attenuation	-	0.3	11	1	100	100	11	1	2.2	0.5	0.5	2.2
250 (Pending)	High voltage filter	520	0.3	7.5	1.1	50	50	7.5	1.1	2	1	1	2
340 (Pending)	Excellent attenuation	-	0.2	11	1	100	100	22	1	2.2	0.33	0.33	2.2
340 (Pending)	High voltage filter	520	0.2	7.5	1.1	50	50	15	1.1	2	1	1	2
450 (Pending)	Excellent attenuation	-	0.2	11	1	100	100	22	1	2.2	0.33	0.33	2.2
550 (Pending)	Excellent attenuation	-	0.2	11	1	100	100	22	1	2.2	0.33	0.33	2.2
1100 (Pending)	High voltage filter	520	0.12	11	1.1	50	-	22	1.1	2	0.5	0.25	2

Diagrams

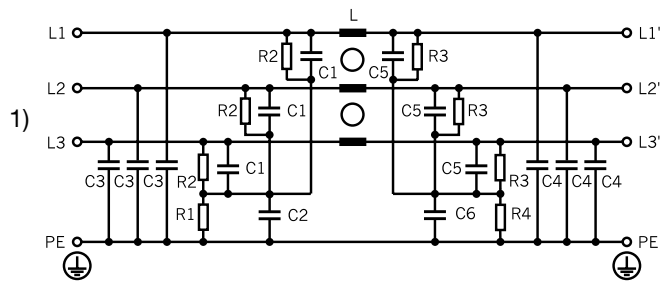

1) Line

Derating Curves

Permissible Working Current as a Function of Ambient Temperature

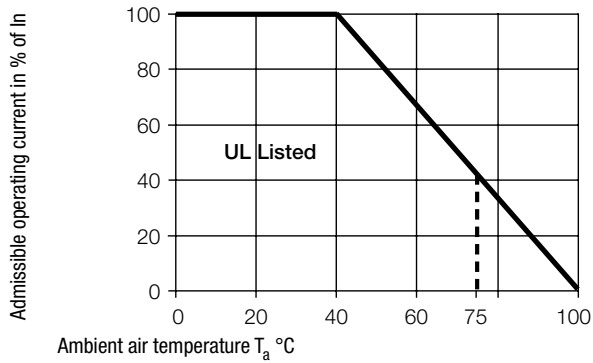

Attenuation Loss

Industrial version

--- 50Ω differential mode ___ 50Ω common mode

6A (FMAC-0924-0610)

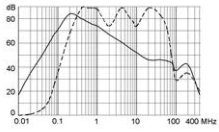

8A (FMAC-0931-0810)

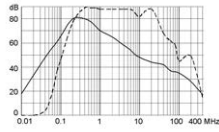

16A (FMAC-0931-1610)
16A (FMAC-0932-1610)

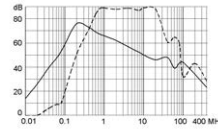

16A (FMAC-0931-1612I)

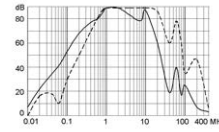

25A (FMAC-0932-2510)

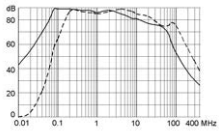

25A (FMAC-0932-2510L)

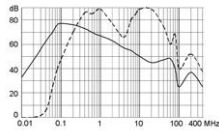

25A (FMAC-0932-2512I)

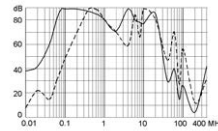

36A (FMAC-0934-3610)

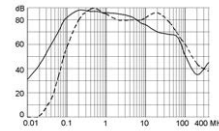

36A (FMAC-0932-3610L)

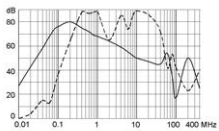

36A (FMAC-0932-3612I)

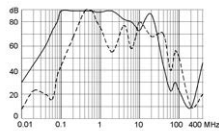

50A (FMAC-0934-5010)

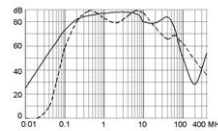

50A (FMAC-0934-5010L)

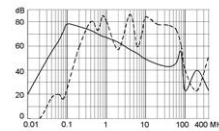

50A (FMAC-0934-5012I)

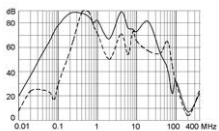

64A (FMAC-0953-6410)

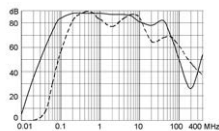

64A (FMAC-0934-6410L)

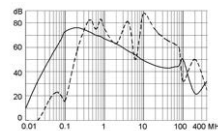

64A (FMAC-0953-6412I)

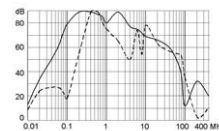

80A (FMAC-0937-8010)

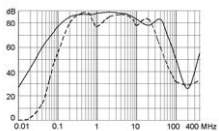

80A (FMAC-0937-8012I)

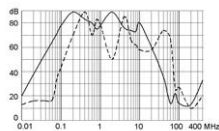

110A (FMAC-0954-H110)

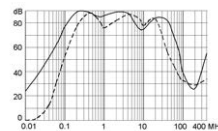

110A (FMAC-0954-H112I)

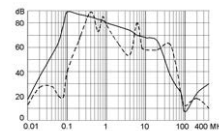

180A (FMAC-0955-H210)

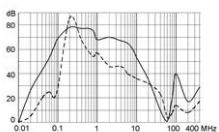

180A (FMAC-0955-H212I)

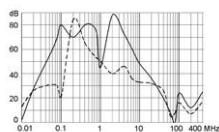

250A (FMAC-0956-H310)

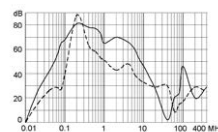

250A (FMAC-0956-H312I)

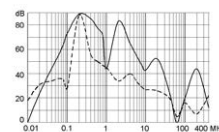

340A (FMAC-0956-H410)

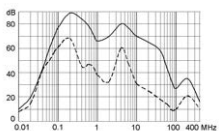

340A (FMAC-0956-H412I)

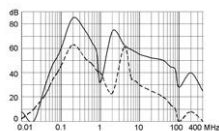

450A (FMAC-0957-H550)

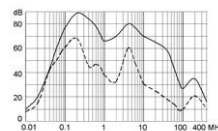

550A (FMAC-0957-H650)

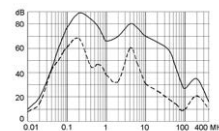

1100A (FMAC-0974-K152I)

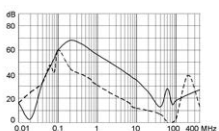

All Variants

Rated Current @ Ta 40°C (75°C) [A]	Characteristic	Rated Voltage [VAC]	Tripped Power Dissipation [W]	Leakage Current [mA] @ 440V, 60Hz ¹⁾	Contact Resistance [mΩ]	Weight [kg]	Screw clamps [mm ²] ²⁾	Housings	Order Number
6 (6)	Excellent attenuation	-	2.48	40	23	0.9kg	4	24-3	FMAC-0924-0610
8 (5)	Excellent attenuation	480	5.38	1.3	28	1.8kg	4	31-3	FMAC-0931-0810
16 (10)	Excellent attenuation	480	8.83	1.3	11.5	1.8kg	4	31-3	FMAC-0931-1610
16 (Pending)	High voltage filter	520	8.83	0.7	11.5	1.8kg	4	31-3	FMAC-0931-1612I
16 (10)	Excellent attenuation	-	8.83	1.3	11.5	2.8kg	4	32-3	FMAC-0932-1610
25 (15)	Excellent attenuation	-	8.25	8.4	4.4	3.4kg	6	32-7	FMAC-0932-2510
25 (14)	High attenuation	-	9.86	8.4	5.26	3.5kg	4	32-7	FMAC-0932-2510L
25 (Pending)	High voltage filter	520	8.25	8.6	4.4	3.35kg	6	32-7	FMAC-0932-2512I
36 (20)	High attenuation	-	10.55	8.4	2.71	3.75kg	6	32-C	FMAC-0932-3610L
36 (20)	Excellent attenuation	-	12.91	8.6	3.32	3.5kg	6	34-3	FMAC-0934-3610
36 (Pending)	High voltage filter	520	12.91	8.6	3.32	3.3kg	6	34-3	FMAC-0934-3612I
50 (32)	Excellent attenuation	-	9.75	9.0	1.3	3.4kg	6	34-3	FMAC-0934-5010
50 (30)	High attenuation	-	12.63	9.0	1.68	3.6kg	6	34-C	FMAC-0934-5010L
50 (Pending)	High voltage filter	520	9.75	9.0	1.3	3.35kg	6	34-3	FMAC-0934-5012I
64 (37)	High attenuation	-	18.23	8.6	1.48	4.2kg	6	34-C	FMAC-0934-6410L
80 (45)	Excellent attenuation	-	22.6	9.7	1.17	7kg	25	37-3	FMAC-0937-8010
80 (Pending)	High voltage filter	520	22.6	9.7	1.17	7.28kg	25	37-3	FMAC-0937-8012I
64 (37)	Excellent attenuation	480	13.52	9.0	1.1	3.9kg	25	53-3	FMAC-0953-6410
64 (Pending)	High voltage filter	520	13.52	9.0	1.1	3.8kg	25	53-3	FMAC-0953-6412I
110 (70)	Excellent attenuation	-	27.23	9.7	0.75	7.5kg	50	54-3	FMAC-0954-H110
110 (Pending)	High voltage filter	520	27.23	9.7	0.75	7.45kg	50	54-3	FMAC-0954-H112I
180 (Pending)	Excellent attenuation	-	36	9.7	0.37	22kg	95	55-3	FMAC-0955-H210
180 (Pending)	High voltage filter	520	36	9.7	0.37	23kg	95	55-3	FMAC-0955-H212I
250 (Pending)	Excellent attenuation	-	36	10.5	0.2	23.7kg	240	56-3	FMAC-0956-H310
250 (Pending)	High voltage filter	520	36	9.1	0.2	25kg	240	56-3	FMAC-0956-H312I
340 (Pending)	Excellent attenuation	-	45	10.5	0.13	27kg	240	56-3	FMAC-0956-H410
340 (Pending)	High voltage filter	520	45	5.6	0.13	30kg	240	56-3	FMAC-0956-H412I
450 (Pending)	Excellent attenuation	-	40	10.5	0.06	33kg	(B)	57	FMAC-0957-H550
550 (Pending)	Excellent attenuation	-	45	10.5	0.046	32kg	(B)	57	FMAC-0957-H650
1100 (Pending)	High voltage filter	520	80	9.5	0.022	47kg	(A)	74	FMAC-0974-K152I

Most Popular.

Availability for all products can be searched real-time: <http://www.schurter.com/en/Stock-Check/Stock-Check-SCHURTER>

6A version: packing unit 2 pcs.

(A): Connecting straps for M12

(B): Connecting straps for M10

1) Nominal leakage current acc. to IEC60950 - 5.2.5. under normal operating conditions. Note: worst case leakage current acc. to IEC60950 - Annex G4 (situation with two interrupted lines) can be much higher.

2) Maximum conductor cross section (wire gauge) to be used; a comparative table for AWG and mm² values can be found in the general product information www.schurter.com/emc_info

Packaging unit 1 Pcs