

THIS COPY IS PROVIDED ON A RESTRICTED BASIS AND IS NOT TO BE USED IN ANY WAY DETRIMENTAL TO THE INTERESTS OF PANDUIT CORP.

Material	High Conductivity Seamless Copper Tube
Plating	Electro-Tin
Wire Size	250 kcmil
Wire Type	Stranded Copper; Class B: Compact, Compressed or Concentric, Class C: Concentric
Wire Strip Length	1-11/16 in.
Stud Size	5/16 in.
UL Listed Wire Connector	Yes, for applications up to 35kv. Consult cable manufacturer for voltage stress relief instructions with applications greater than 2000 volts.
UL Temperature Rating	90° C
C.S.A Certified Wire Connector	Yes
Panduit Color Code on Barrel	YELLOW
Panduit Die Index No. on Barrel	P62
Alternate Industry Die Index No. () on Barrel	(16)

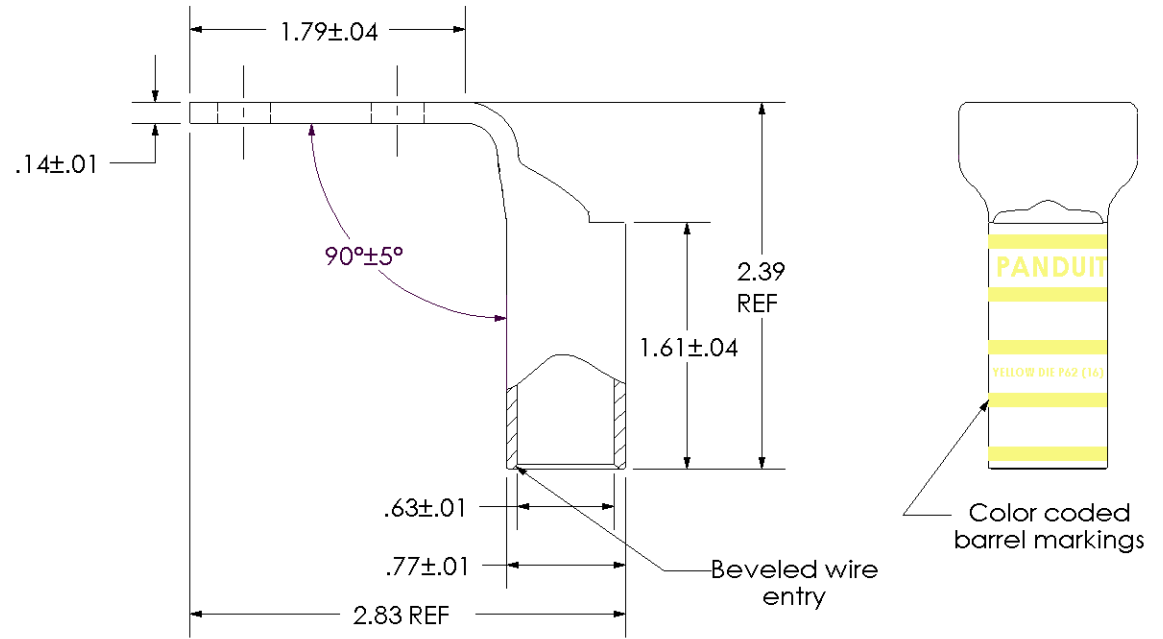
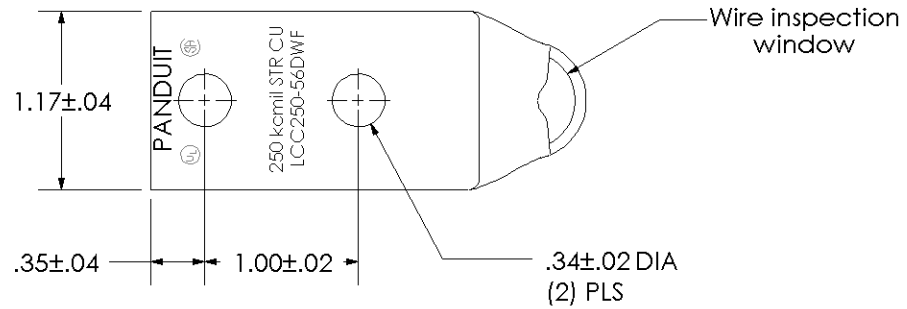

PANDUIT CORP. TINLEY PARK, ILLINOIS

LCC250-56DWF-X
Copper Lug - Two-Hole, Long Barrel with Window, 90° Angle Tongue

00	9/02	SAB	DRL
REV	DATE	BY	CHK

RELEASED

10342

DESCRIPTION

ECN

SCALE
N/A

DRAWING NO / CAD FILE

LCC250-56DWF-CUST