

PR308T11ESZ

*Zero cross type is also available. (PR308T21ESZ)

$I_T(\text{rms}) \leq 8\text{A}$, Reinforced Insulation Type
 Non-Zero Cross type
 Low profile SIP 4pin
 Triac output SSR

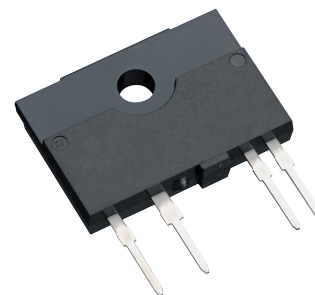

■ Description

PR308T11ESZ reinforced insulation type Solid State Relays (SSR) are an integration of an infrared emitting diode (IRED), a Phototriac Detector and a main output Triac. These devices are ideally suited for controlling high voltage AC loads with solid state reliability while providing 3.0kV isolation ($V_{\text{iso}}(\text{rms})$) from input to output.

■ Features

1. Output current, $I_T(\text{rms}) \leq 8.0\text{A}$
2. Non-zero crossing functionary
3. Slim 4 pin low profile SIP package
4. Reinforced insulation type (MIN. 0.4mm internal separation)
5. High repetitive peak off-state voltage ($V_{\text{DRM}} : 600\text{V}$)
6. High isolation voltage between input and output ($V_{\text{iso}}(\text{rms}) : 3.0\text{kV}$)
7. Screw hole for heat sink

■ Agency approvals/Compliance

1. Recognized by UL508, file No. E94758 (as models No. **PR308T11**)
2. Approved by CSA 22.2 No.14, file No. LR63705 (as models No. **PR308T11**)
3. Approved by TÜV EN60950 (reinforced insulation), file No. R9750791 (as model No. **PR308T11**)
4. Package resin : UL flammability grade (94V-0)

■ Applications

1. Isolated interface between high voltage AC devices and lower voltage DC control circuitry.
2. Switching motors, fans, heaters, solenoids, and valves.
3. Phase or power control in applications such as lighting and temperature control equipment.

Notice The content of data sheet is subject to change without prior notice.

In the absence of confirmation by device specification sheets, SHARP takes no responsibility for any defects that may occur in equipment using any SHARP devices shown in catalogs, data books, etc. Contact SHARP in order to obtain the latest device specification sheets before using any SHARP device.

■ Internal Connection Diagram

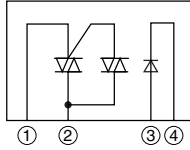

- ① Output (Triac T1)
- ② Output (Triac T2)
- ③ Input (+)
- ④ Input (-)

■ Outline Dimensions

(Unit : mm)

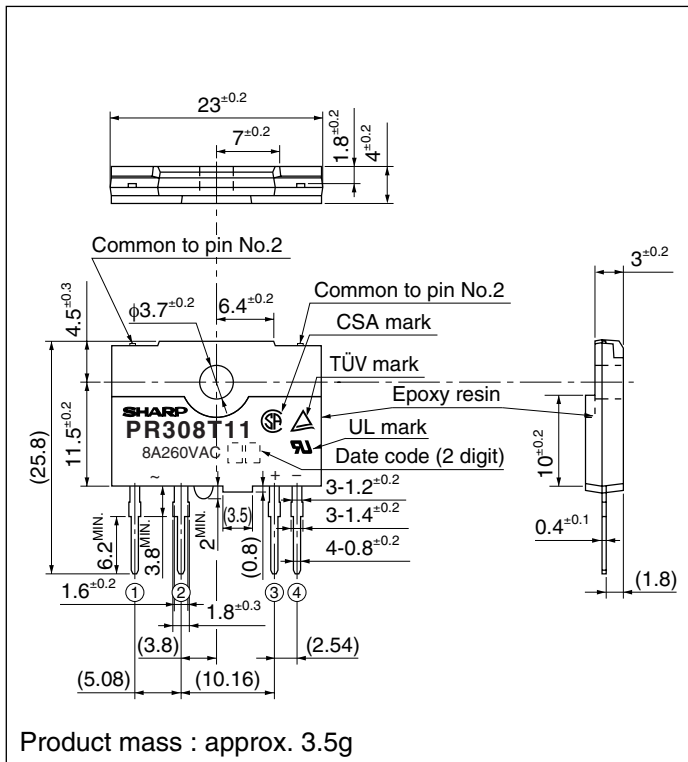

() : Typical dimensions

Date code (2 digit)

1st digit				2nd digit	
Year of production				Month of production	
A.D.	Mark	A.D	Mark	Month	Mark
1990	A	2002	P	January	1
1991	B	2003	R	February	2
1992	C	2004	S	March	3
1993	D	2005	T	April	4
1994	E	2006	U	May	5
1995	F	2007	V	June	6
1996	H	2008	W	July	7
1997	J	2009	X	August	8
1998	K	2010	A	September	9
1999	L	2011	B	October	O
2000	M	2012	C	November	N
2001	N	∴	∴	December	D

repeats in a 20 year cycle

Country of origin

Japan

Rank mark

There is no rank mark indicator and currently there are no rank offered for this device.

■ Absolute Maximum Ratings

(T_a=25°C)

Parameter		Symbol	Rating	Unit
Input	Forward current	I _F	50 ^{*3}	mA
	Reverse voltage	V _R	6	V
Output	RMS ON-state current	I _{T(rms)}	8 ^{*3}	A
	Peak one cycle surge current	I _{surge}	80 ^{*4}	A
	Repetitive peak OFF-state voltage	V _{DRM}	600	V
	Non-Repetitive peak OFF-state voltage	V _{DSM}	600	V
	Critical rate of rise of ON-state current	dI _T /dt	50	A/μs
	Operating frequency	f	45 to 65	Hz
	*1 Isolation voltage	V _{iso(rms)}	3.0	kV
Operating temperature	T _{opr}	-25 to +100	°C	
Storage temperature	T _{stg}	-30 to +125	°C	
*2 Soldering temperature	T _{sol}	260	°C	

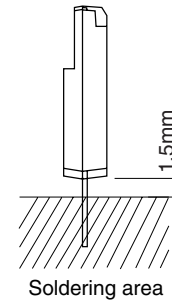

*1 40 to 60%RH, AC for 1minute, f=60Hz

*2 For 10s

*3 Refer to Fig.1, Fig.2

*4 f=50Hz sine wave, T_j=25°C start

■ Electro-optical Characteristics

(T_a=25°C)

Parameter		Symbol	Conditions	MIN.	TYP.	MAX.	Unit
Input	Forward voltage	V _F	I _F =20mA	-	1.2	1.4	V
	Reverse current	I _R	V _R =3V	-	-	100	μA
Output	Repetitive peak OFF-state current	I _{DRM}	V _D =V _{DRM}	-	-	100	μA
	ON-state voltage	V _{T(rms)}	I _{T(rms)} =2A, Resistance load, I _F =20mA	-	-	1.5	V
	Holding current	I _H	-	-	-	50	mA
	Critical rate of rise of OFF-state voltage	dV/dt	V _D =2/3•V _{DRM}	30	-	-	V/μs
	Critical rate of rise of OFF-state voltage at commutation	(dV/dt) _c	T _j =125°C, V _D =2/3•V _{DRM} , dI _T /dt=-4.0A/ms	5	-	-	V/μs
Transfer characteristics	Minimum trigger current	I _{FT}	V _D =12V, R _L =30Ω	-	-	10	mA
	Isolation resistance	R _{ISO}	DC500V, 40 to 60%RH	10 ¹⁰	-	-	Ω
	Turn-on time	t _{on}	V _{D(rms)} =200V, AC50Hz, I _F =20mA	-	-	1	ms
	Turn-off time	t _{off}	I _{T(rms)} =2A, Resistance load	-	-	10	ms
Thermal resistance		R _{th(j-c)}	Between junction and case	-	4.5	-	°C/W
		R _{th(j-a)}	Between junction and ambience	-	40	-	

■ Model Line-up (Lead solder plating components)

Shipping Package	Sleeve		V _{DRM} [V]	I _{FT} [mA] (V _D =12V, R _L =30Ω)
	25pcs/sleeve			
EN60950 (reinforced insulation)	————	Approved		
Model No.	————	PR308T11ESZ	600	MAX.10

Please contact a local SHARP sales representative to see the actual status of the production.

Fig.1 Forward Current vs. Ambient Temperature

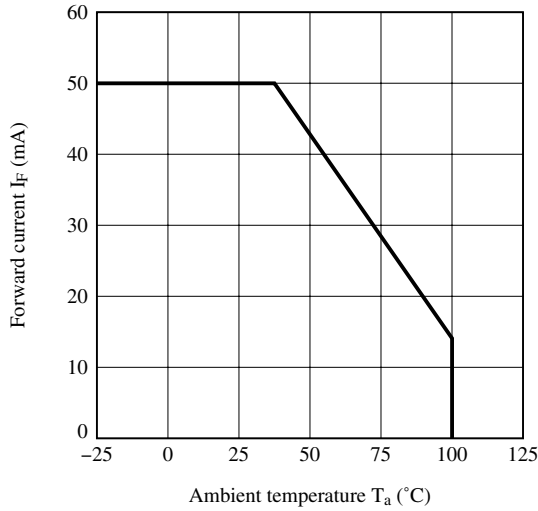
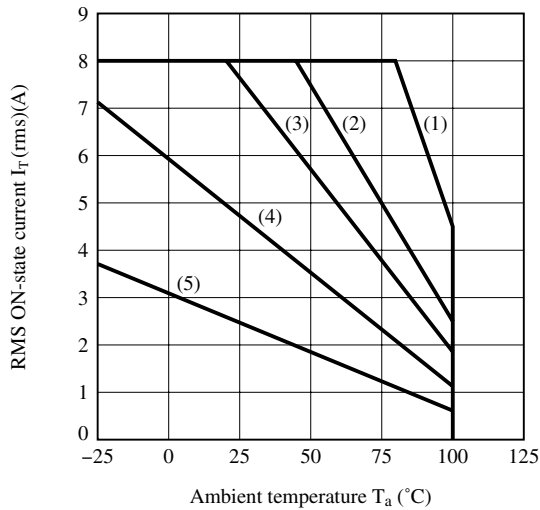

Fig.2 RMS ON-state Current vs. Ambient Temperature



- (1) With infinite heat sink
- (2) With heat sink (200×200×2mm Al plate)
- (3) With heat sink (100×100×2mm Al plate)
- (4) With heat sink (50×50×2mm Al plate)
- (5) Without heat sink

(Note) In natural cooling condition, please locate Al plate vertically, spread the thermal conductive silicone grease on the touch surface of the device and tighten up the device in the center of Al plate at the torque of 0.4N•m.

Fig.3 RMS ON-state Current vs. Case Temperature

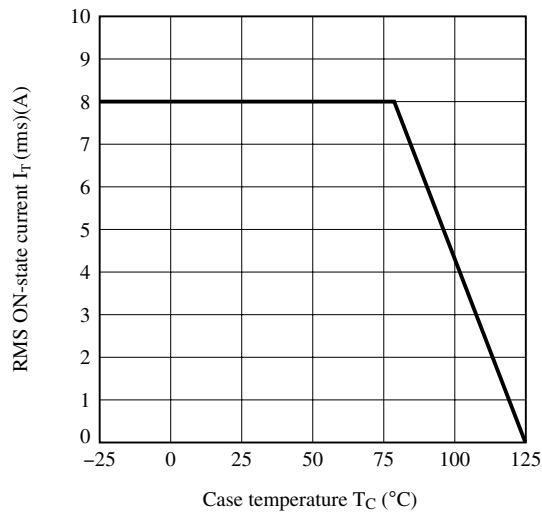

Fig.4 Forward Current vs. Forward Voltage

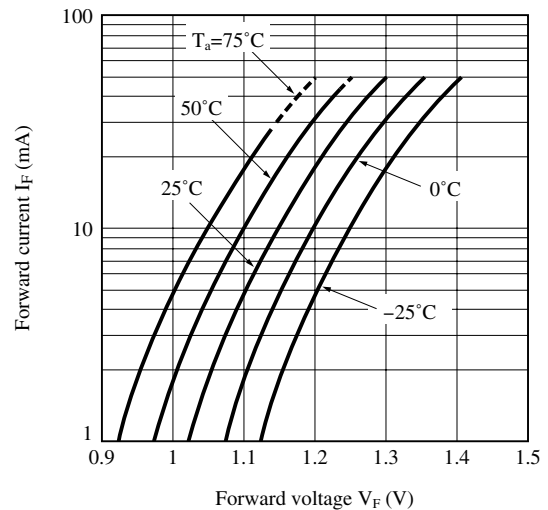

Fig.5 Surge Current vs. Power-on Cycle

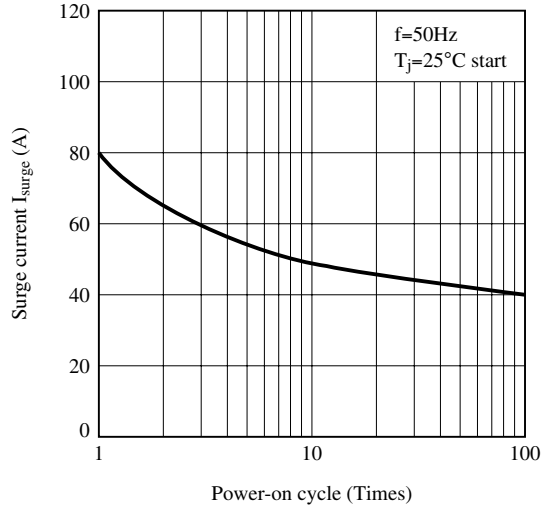

Fig.6 Minimum Trigger Current vs. Ambient Temperature

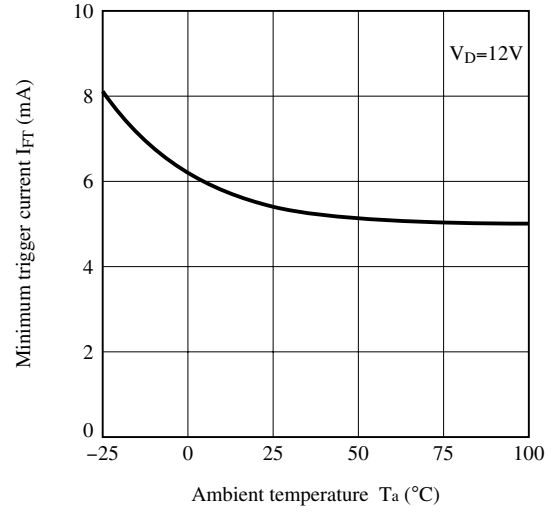

Fig.7 Maximum ON-state Power Dissipation vs. RMS ON-state Current

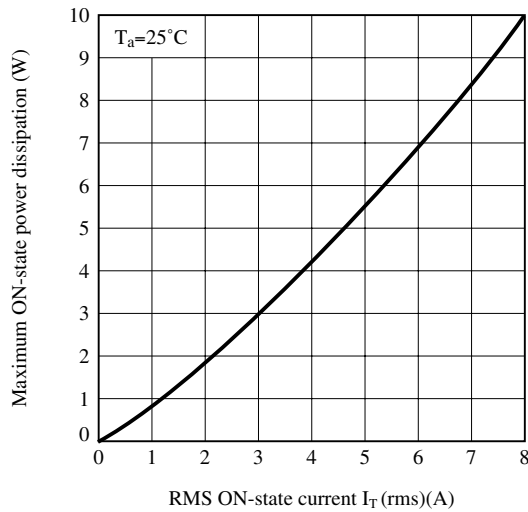
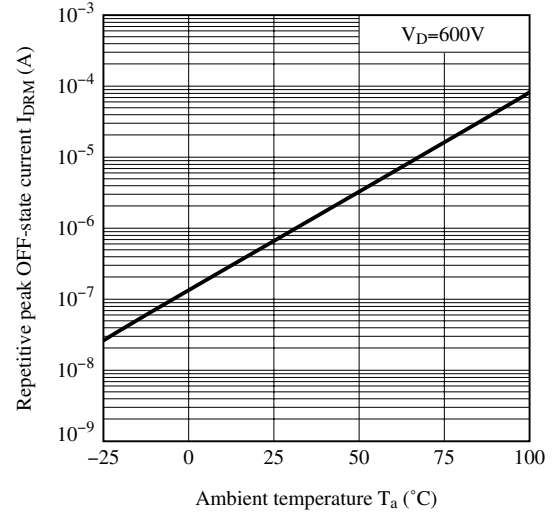

Fig.8 Repetitive Peak OFF-state Current vs. Ambient Temperature



Remarks : Please be aware that all data in the graph are just for reference.

■ Design Considerations

● Recommended Operating Conditions

Parameter		Symbol	Conditions	MIN.	MAX.	Unit
Input	Input signal current at ON state	$I_F(\text{ON})$	–	20	30	mA
	Input signal current at OFF state	$I_F(\text{OFF})$	–	0	0.1	mA
Output	Load supply voltage	$V_{\text{OUT}}(\text{rms})$	–	80	240	V
	Load supply current	$I_{\text{OUT}}(\text{rms})$	Locate snubber circuit between output terminals ($C_s=0.022\mu\text{F}$, $R_s=47\Omega$)	0.1	$I_T(\text{rms})$ $\times 80\%$ (*)	mA
	Frequency	f	–	47	63	Hz
Operating temperature		T_{opr}	–	–20	80	°C

(*) See Fig.2 about derating curve ($I_T(\text{rms})$ vs. ambient temperature).

● Design guide

In order for the SSR to turn off, the triggering current (I_F) must be 0.1mA or less.

In phase control applications or where the SSR is being by a pulse signal, please ensure that the pulse width is a minimum of 1ms.

When the input current (I_F) is below 0.1mA, the output Triac will be in the open circuit mode. However, if the voltage across the Triac, V_D , increases faster than rated dV/dt , the Triac may turn on. To avoid this situation, please incorporate a snubber circuit. Due to the many different types of load that can be driven, we can merely recommend some circuit vales to start with : $C_s=0.022\mu\text{F}$ and $R_s=47\Omega$. The operation of the SSR and snubber circuit should be tested and if unintentional switching occurs, please adjust the snubber circuit component values accordingly.

When making the transition from On to Off state, a snubber circuit should be used ensure that sudden drops in current are not accompanied by large instantaneous changes in voltage across the Triac.

This fast change in voltage is brought about by the phase difference between current and voltage.

Primarily, this is experienced in driving loads which are inductive such as motors and solenoids.

Following the procedure outlined above should provide sufficient results.

Any snubber or Varistor used for the above mentioned scenarios should be located as close to the main output triac as possible.

The load current should be within the bounds of derating curve. (Refer to Fig.2)

Also, please use the optional heat sink when necessary.

In case the optional heat sink is used and the isolation voltage between the device and the optional heat sink is needed, please locate the insulation sheet between the device and the heat sink.

When the optional heat sink is equipped, please set up the M3 screw-fastening torque at 0.3 to 0.5N•m.

In order to dissipate the heat generated from the inside of device effectively, please follow the below suggestions.

- Make sure there are no warps or bumps on the heat sink, insulation sheet and device surface.
- Make sure there are no metal dusts or burrs attached onto the heat sink, insulation sheet and device surface.
- Make sure silicone grease is evenly spread out on the heat sink, insulation sheet and device surface.

Silicone grease to be used is as follows;

- 1) There is no aged deterioration within the operating temperature ranges.
- 2) Base oil of grease is hardly separated and is hardly permeated in the device.
- 3) Even if base oil is separated and permeated in the device, it should not degrade the function of a device.

Recommended grease : G-746 (Shin-Etsu Chemical Co., Ltd.)
 : G-747 (Shin-Etsu Chemical Co., Ltd.)
 : SC102 (Dow Corning Toray Silicone Co., Ltd.)

In case the optional heat sink is screwed up, please solder after screwed.

In case of the lead frame bending, please keep the following minimum distance and avoid any mechanical stress between the base of terminals and the molding resin.

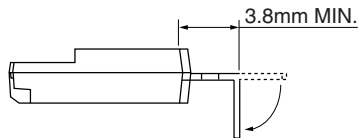

Some of AC electromagnetic counters or solenoids have built-in rectifier such as the diode.

In this case, please use the device carefully since the load current waveform becomes similar with rectangular waveform and this results may not make a device turn off.

Example how to equip optional heat sink for reinforced isolation

(a) Case of the use of isolation sheet whose thickness is 0.4mm or more (V_{iso} : 3kV or more)

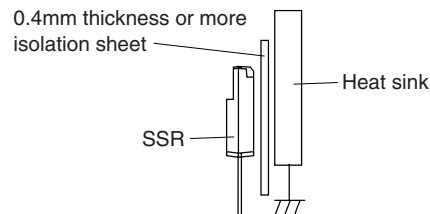

(b) Case of the use of double isolation sheet (V_{iso} : each 3kV or more)

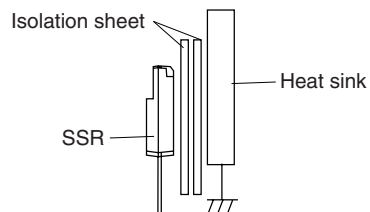

Please keep 5mm distance as minimum between naked metal portion of SSR and heat sink, and also between naked metal portion of SSR and bis/nut/washer.

However, please avoid the natural rubber for isolation sheet.

● Degradation

In general, the emission of the IRED used in SSR will degrade over time.

In the case where long term operation and / or constant extreme temperature fluctuations will be applied to the devices, please allow for a worst case scenario of 50% degradation over 5years.

Therefore in order to maintain proper operation, a design implementing these SSRs should provide at least twice the minimum required triggering current from initial operation.

● **Standard Circuit**

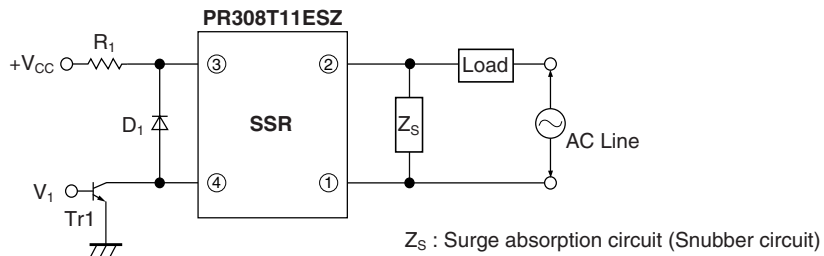

☆ For additional design assistance, please review our corresponding Optoelectronic Application Notes.

■ Manufacturing Guidelines**● Soldering Method****Flow Soldering (No solder bathing)**

Flow soldering should be completed below 260°C and within 10s.

Preheating is within the bounds of 100 to 150°C and 30 to 80s.

Please solder within one time.

Other notices

Please test the soldering method in actual condition and make sure the soldering works fine, since the impact on the junction between the device and PCB varies depending on the tooling and soldering conditions.

● Cleaning instructions**Solvent cleaning :**

Solvent temperature should be 45°C or below. Immersion time should be 3minutes or less.

Ultrasonic cleaning :

The impact on the device varies depending on the size of the cleaning bath, ultrasonic output, cleaning time, size of PCB and mounting method of the device.

Therefore, please make sure the device withstands the ultrasonic cleaning in actual conditions in advance of mass production.

Recommended solvent materials :

Ethyl alcohol, Methyl alcohol and Isopropyl alcohol.

In case the other type of solvent materials are intended to be used, please make sure they work fine in actual using conditions since some materials may erode the packaging resin.

● Presence of ODC

This product shall not contain the following materials.

And they are not used in the production process for this device.

Regulation substances : CFCs, Halon, Carbon tetrachloride, 1.1.1-Trichloroethane (Methylchloroform)

Specific brominated flame retardants such as the PBBOs and PBBs are not used in this product at all.

■ **Package specification**

● **Sleeve package**

Package materials

Sleeve : HIPS

Stopper : Olefine-Elastomer

Package method

MAX. 25pcs of products shall be packaged in a sleeve.

Both ends shall be closed by stoppers.

MAX. 20 sleeves in one case.

Sleeve outline dimensions

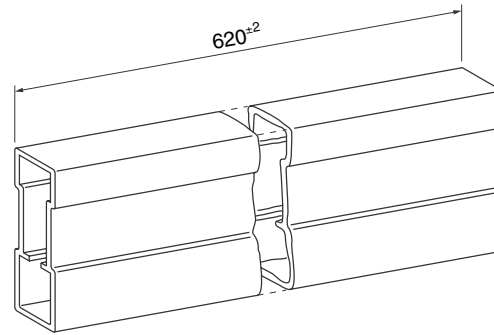
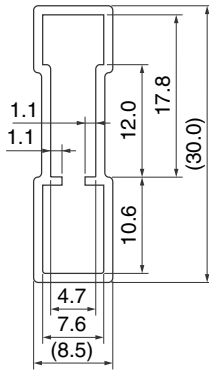

(Unit : mm)

■ Important Notices

· The circuit application examples in this publication are provided to explain representative applications of SHARP devices and are not intended to guarantee any circuit design or license any intellectual property rights. SHARP takes no responsibility for any problems related to any intellectual property right of a third party resulting from the use of SHARP's devices.

· Contact SHARP in order to obtain the latest device specification sheets before using any SHARP device. SHARP reserves the right to make changes in the specifications, characteristics, data, materials, structure, and other contents described herein at any time without notice in order to improve design or reliability. Manufacturing locations are also subject to change without notice.

· Observe the following points when using any devices in this publication. SHARP takes no responsibility for damage caused by improper use of the devices which does not meet the conditions and absolute maximum ratings to be used specified in the relevant specification sheet nor meet the following conditions:

(i) The devices in this publication are designed for use in general electronic equipment designs such as:

- Personal computers
- Office automation equipment
- Telecommunication equipment [terminal]
- Test and measurement equipment
- Industrial control
- Audio visual equipment
- Consumer electronics

(ii) Measures such as fail-safe function and redundant design should be taken to ensure reliability and safety when SHARP devices are used for or in connection

with equipment that requires higher reliability such as:

- Transportation control and safety equipment (i.e., aircraft, trains, automobiles, etc.)
- Traffic signals
- Gas leakage sensor breakers
- Alarm equipment
- Various safety devices, etc.

(iii) SHARP devices shall not be used for or in connection with equipment that requires an extremely high level of reliability and safety such as:

- Space applications
- Telecommunication equipment [trunk lines]
- Nuclear power control equipment
- Medical and other life support equipment (e.g., scuba).

· If the SHARP devices listed in this publication fall within the scope of strategic products described in the Foreign Exchange and Foreign Trade Law of Japan, it is necessary to obtain approval to export such SHARP devices.

· This publication is the proprietary product of SHARP and is copyrighted, with all rights reserved. Under the copyright laws, no part of this publication may be reproduced or transmitted in any form or by any means, electronic or mechanical, for any purpose, in whole or in part, without the express written permission of SHARP. Express written permission is also required before any use of this publication may be made by a third party.

· Contact and consult with a SHARP representative if there are any questions about the contents of this publication.