

# Industrial Ethernet Cables

## XS5/XS6

### Cables and Connectors for EtherCAT® and Other Industrial Ethernet Networks

#### CAT6a Ethernet patch cables

- For in-cabinet use
- LSZH with standard RJ45 plugs

#### CAT5e Ethernet patch cables

- For out-of-cabinet use
- PUR with standard RJ45 plugs
- PVC with rugged RJ45 plugs
- PVC with M12 SmartClick plugs
- In addition to cables with sockets and robot cables, shield strengthening cables joined.



### Connection Examples

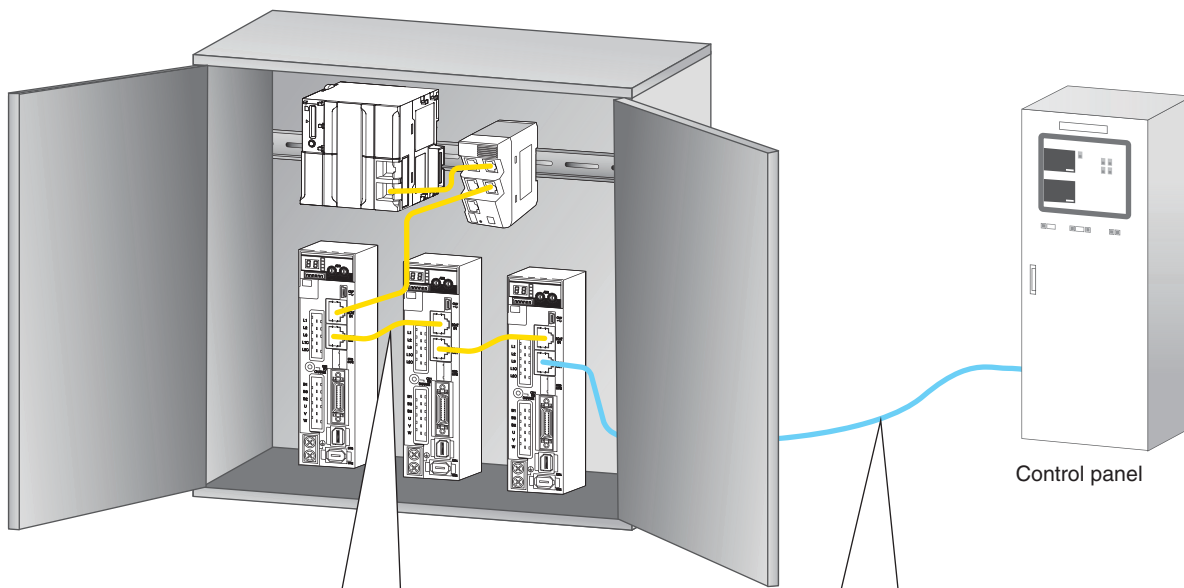

**Ideal for in-cabinet**  
XS6W-6LSZH

Standard Connectors

**Ideal for out-of-cabinet**

XS6W-5PUR	XS5	XS6
Standard Connectors	Rugged Connectors	Rugged Assembly Connectors

XS5		
M12 Connectors (Waterproof)		

## ■ Features

### Cables with Standard RJ45 Connectors

For details, refer to page 4.

- The lineup features LSZH cables\* for in-panel wiring and PUR cables for wiring outside of panels.
- The Standard RJ45 Connectors reduce cable routing space. LSZH cables are AWG26 with an outer diameter of 6.3 mm. PUR Cables are AWG26 with an outer diameter of 6.0 mm.
- Cable colors include blue, yellow, or green.
- LSZH cables are available in 12 lengths from 0.2 to 20 m and PUR cables are available in 10 lengths from 0.5 to 20 m.
- Single-shielded cables with individual aluminum tape on each wire pair to reduce EMC interference in industrial environments.

Note. PUR cables are double-shielded cables with overall braiding and individual aluminum tape on each wire pair.

\* Low-smoke zero-halogen cables.

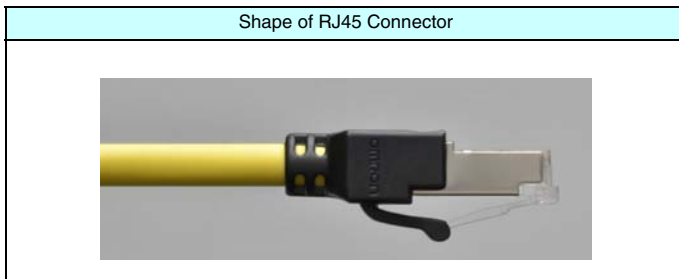

### Cables with Rugged RJ45 Connectors

For details, refer to page 7.

- Tough latches and RJ45 connectors with strong cable holding strength are used to enable connections outside of control panels.
- Quad AWG22 cable with PVC cover of 6.5 mm outer diameter.
- Double-shielded cables with overall braiding and individual foil shield to reduce EMC interference in industrial environments.

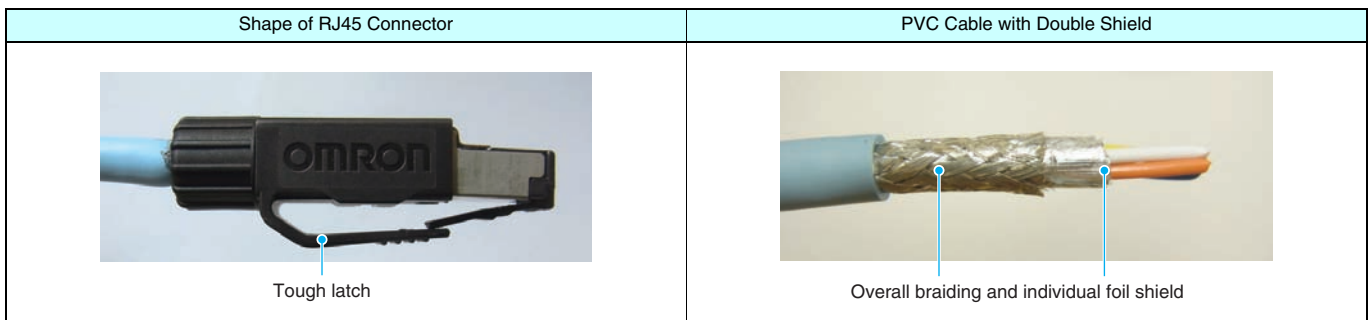

### Assembly Connectors

You can easily assemble Ethernet cables onsite without crimping tools or other special tools.

Refer to page 14 for the assembly procedure.

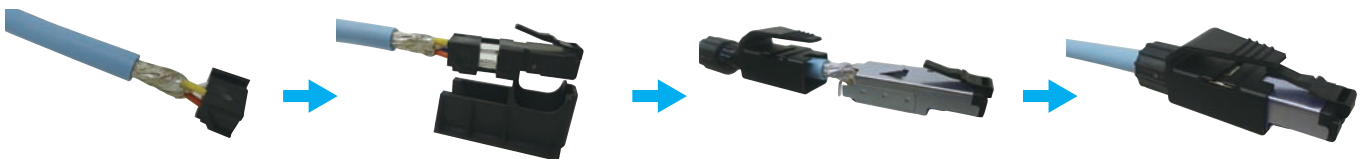

#### ● Cable Extension Length

##### Standard Connectors (RJ45 Connectors)

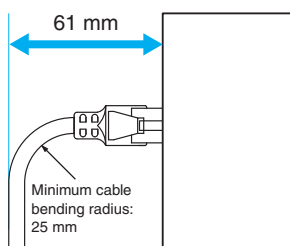

##### Rugged Connectors (RJ45 Connectors)

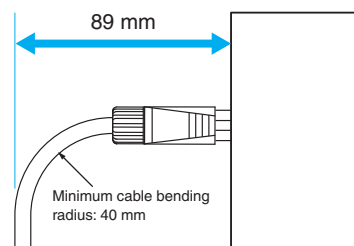

### Cables with M12 Connectors (Waterproof)

For details, refer to page 7.

- Resistance to harsh environments with IP67 protection.
- SmartClick Connectors that provide one-step (1/8th turn) connection are used (compatible with standard M12 screw connectors).
- A wide range of variations, such as cables with right-angle connectors and PCB connectors.
- Cables with sockets and robot cables were added to the series.

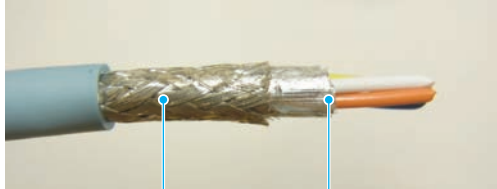
Shape of M12 Connector	PVC Cable with Double Shield
 <p>Shield structure</p>	 <p>Overall braiding and individual foil shield</p>

### Cables with M12 Connectors Shield Strengthening Cables specification

For details, refer to page 7.

- Cable specification with strengthened shield for higher noise resistance. Recommended for EtherCAT communications.
- In addition to a double shield structure, copper foil tape is added to the M12 connector to improve communication characteristics (see below).

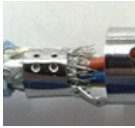
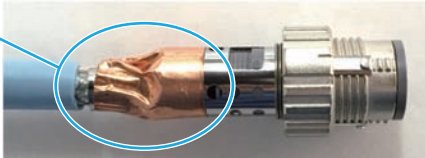
Shield Strengthening Cable (Double shield structure + copper foil tape wrapping)	
<p>&lt;Internal structure&gt;</p> 	<p>Noise resistance is strengthened by wrapping copper foil tape around the part where the cable in the M12 connector joins the shield plate.</p> 

### Shield Effectiveness Data for Rugged RJ45 Connectors and M12 Connectors (Waterproof)

The following data is the results of OMRON testing. Shield effectiveness may vary for your environment and application conditions.

#### ● Comparison of Shield Effectiveness with Product without a Double Shield

The following table shows the differences with a structure without a double shield. Higher numeric values show greater shield effectiveness.

Shield structure	Frequency (MHz)				
	0.5	1	5	10	30
Product with single shield	53 dB	49 dB	35 dB	25 dB	17 dB
Product with a double shield (XS5□-T, Category 5E)	61 dB	58 dB	43 dB	31 dB	27 dB

- SmartClick is a registered trademark of OMRON Corporation.
- EtherCAT® is a registered trademark and patented technology, licensed by Beckhoff Automation GmbH, Germany.
- Other company names and product names in this document are the trademarks or registered trademarks of their respective companies.

## Cables with Standard RJ45 Connectors

## ■ Model Number Legend

Use this legend when determining the product specifications from the model number. Choose from the model numbers listed in *Ordering Information* when ordering.

**XS6W-**□ □□□□ **8 SS** □□□□**CM-**□

①            ②            ③   ④            ⑤            ⑥

① **Transmission Characteristics**

5: Category 5

6: Category 6A

② **Sheath Material**

LSZH: LSZH

PUR: PUR

③ **Number of Pins**

8: 8 pins

④ **Cable Attachment Direction**

SS: Straight/Straight

⑤ **Cable Length\***

20: 0.2 m

30: 0.3 m

50: 0.5 m

100: 1 m

150: 1.5 m

200: 2 m

300: 3 m

500: 5 m

750: 7.5 m

1000: 10 m

1500: 15 m

2000: 20 m

⑥ **Sheath Color**





B: Blue

Y: Yellow

G: Green

\* PUR cables are not available for 0.2-m and 0.3-m cables.

## Ordering Information

Appearance	Type	Category	Cable sheath material	Cable color	Cable length (m)	Model
	Cable with Connectors on Both Ends (RJ45/RJ45)	Cat.6a	LSZH	Blue	0.2	XS6W-6LSZH8SS20CM-B
					0.3	XS6W-6LSZH8SS30CM-B
					0.5	XS6W-6LSZH8SS50CM-B
					1	XS6W-6LSZH8SS100CM-B
					1.5	XS6W-6LSZH8SS150CM-B
					2	XS6W-6LSZH8SS200CM-B
					3	XS6W-6LSZH8SS300CM-B
					5	XS6W-6LSZH8SS500CM-B
					7.5	XS6W-6LSZH8SS750CM-B
					10	XS6W-6LSZH8SS1000CM-B
					15	XS6W-6LSZH8SS1500CM-B
20	XS6W-6LSZH8SS2000CM-B					
	Cable with Connectors on Both Ends (RJ45/RJ45)	Cat.6a	LSZH	Yellow	0.2	XS6W-6LSZH8SS20CM-Y
					0.3	XS6W-6LSZH8SS30CM-Y
					0.5	XS6W-6LSZH8SS50CM-Y
					1	XS6W-6LSZH8SS100CM-Y
					1.5	XS6W-6LSZH8SS150CM-Y
					2	XS6W-6LSZH8SS200CM-Y
					3	XS6W-6LSZH8SS300CM-Y
					5	XS6W-6LSZH8SS500CM-Y
					7.5	XS6W-6LSZH8SS750CM-Y
					10	XS6W-6LSZH8SS1000CM-Y
					15	XS6W-6LSZH8SS1500CM-Y
20	XS6W-6LSZH8SS2000CM-Y					
	Cable with Connectors on Both Ends (RJ45/RJ45)	Cat.6a	LSZH	Green	0.2	XS6W-6LSZH8SS20CM-G
					0.3	XS6W-6LSZH8SS30CM-G
					0.5	XS6W-6LSZH8SS50CM-G
					1	XS6W-6LSZH8SS100CM-G
					1.5	XS6W-6LSZH8SS150CM-G
					2	XS6W-6LSZH8SS200CM-G
					3	XS6W-6LSZH8SS300CM-G
					5	XS6W-6LSZH8SS500CM-G
					7.5	XS6W-6LSZH8SS750CM-G
					10	XS6W-6LSZH8SS1000CM-G
					15	XS6W-6LSZH8SS1500CM-G
20	XS6W-6LSZH8SS2000CM-G					
	Cable with Connectors on Both Ends (RJ45/RJ45)	Cat.5	PUR	Green	0.5	XS6W-5PUR8SS50CM-G
					1	XS6W-5PUR8SS100CM-G
					1.5	XS6W-5PUR8SS150CM-G
					2	XS6W-5PUR8SS200CM-G
					3	XS6W-5PUR8SS300CM-G
					5	XS6W-5PUR8SS500CM-G
					7.5	XS6W-5PUR8SS750CM-G
					10	XS6W-5PUR8SS1000CM-G
					15	XS6W-5PUR8SS1500CM-G
20	XS6W-5PUR8SS2000CM-G					

## Specifications

Item	Type	Cable with Connectors on Both Ends (RJ45/RJ45)/LSZH	Cable with Connectors on Both Ends (RJ45/RJ45)/PUR
	Model	XS6W-6LSZH8SS□□□□CM-□	XS6W-5PUR8SS□□□□CM-G
Rated current		1 A (at 50°C)	
Withstand voltage		1,000 VDC for 60 s (leakage current: 1 mA max.)	
Ambient operating temperature		-20 to 75°C	-40 to 80°C
Ambient storage temperature		-20 to 75°C	-40 to 80°C
Ambient installation temperature		0 to 50°C	-10 to 60°C
Protective structure		IP20	

## Materials and Finish

### Connectors

Item	Type	Cable with Connectors on Both Ends (RJ45/RJ45)/LSZH	Cable with Connectors on Both Ends (RJ45/RJ45)/PUR
	Model	XS6W-6LSZH8SS□□□□CM-□	XS6W-5PUR8SS□□□□CM-G
Connector housing		PC resin (UL94V-0)/transparent	
Contacts		Copper alloy/nickel base, gold plated	
Shield		Brass/nickel plated	
Cover (structured to prevent the tab from breaking)		PA/Black	
Marking tube		PVC resin (UL94V-0)/transparent	

### Cables

Item	Type	Cable with Connectors on Both Ends (RJ45/RJ45)/LSZH	Cable with Connectors on Both Ends (RJ45/RJ45)/PUR
	Model	XS6W-6LSZH8SS□□□□CM-□	XS6W-5PUR8SS□□□□CM-G
Compliant standard		IEC 60332-1 /UL444	IEC 60332-1
Number of cores		AWG26	
Outer diameter *1		6.3 mm	6.0 mm
Sheath color *2		Blue, yellow, or green	Green
Sheath material		LSZH	PUR
Shield structure		Single shield	Double shield

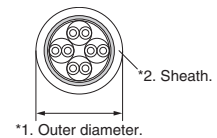

## Dimensions

(Unit: mm)

### Cable with Connectors on Both Ends (RJ45/RJ45)

XS6W-6LSZH8SS□□□□CM-□

XS6W-5PUR8SS□□□□CM-G

### Wiring

RJ45	1	RJ45	1
	2		2
	3		3
	4		4
	5		5
	6		6
	7		7
	8		8
Shield		Shield	

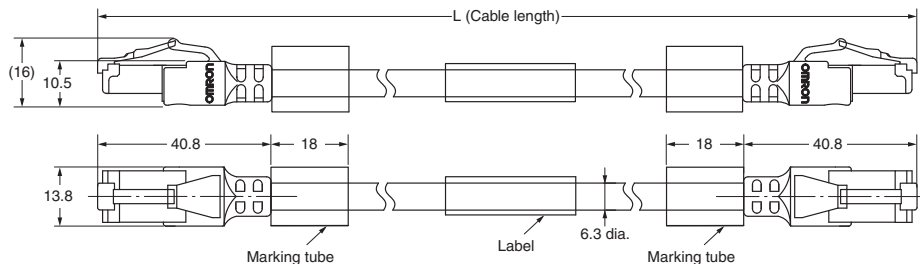

## Cables with Rugged RJ45 Connectors and Cables with M12 Connectors

### Model Number Legend

Use this legend when determining the product specifications from the model number. Choose from the model numbers listed in *Ordering Information* when ordering.

#### ● Cable with Connectors

XS5 □-T 4 2 □-□M□-□□

① ② ③ ④ ⑤ ⑥ ⑦ ⑧

##### ① Connector Shape

H: Cable with plug on one end

W: Cable with connectors on both ends

##### ② Type

T: Ethernet (mating part: M12 D coding)

##### ③ Number of Pins

4: 4 pins

##### ④ Contact Plating Specification

2: Gold plating, 0.4 μm

##### ⑤ Cable Attachment Direction (M12 Connectors)

1: Straight

2: Right angle

##### ⑥ Cable Length

A: 0.3 m

B: 0.5 m

C: 1 m

D: 2 m

E: 3 m

G: 5 m

J: 10 m

K: 15 m

##### ⑦ Connector Shape

0: M12 plug on one end

1: Connectors on both ends: M12 socket/M12 plug

2: Connectors on both ends: M12 plug/M12 plug

C: Connectors on both ends: M12 plug/RJ45 plug

D: Connectors on both ends: RJ45 plug/RJ45 plug

E: Connectors on both ends: M12 socket/RJ45 plug

##### ⑧ Cable Specification

K: Standard cable (Cable color: Light blue)

Y: Standard cable (Cable color: Yellow)

KR: Robot cable (Cable color: Light blue)

YR: Robot cable (Cable color: Yellow)

SS: Shield Strengthening cable (Cable color: Black)

#### ● RJ45 Assembly Connectors

XS6G-T 4 2 1-1

① ② ③ ④ ⑤

##### ① Type

T: Ethernet

##### ② Number of Pins

4: 4 pins

##### ③ Contact Plating Specification

2: Gold plating, 0.4 μm

##### ④ Cable Attachment Direction

1: Straight

##### ⑤ Degree of Protection

1: IP20

#### ● M12 Connectors for Panel Mounting

XS5P-T 4 2 □-□

① ② ③ ④ ⑤

##### ① Type

T: Ethernet (mating part: M12 D coding)

##### ② Number of Pins

4: 4 pins

##### ③ Plating Specification

2: Gold plating, 0.4 μm

##### ④ Mounting Method

6: Rear locking

7: Front locking

##### ⑤ Terminal Shape

1: DIP terminalst



5: Cable with loose wires (0.5 m)

## Ordering Information

Appearance	Cable type	Type	Cable color	Cable length (m)	Model
	Standard Cables	Cable with Plug on One End (M12 Straight)	Light blue	0.5	XS5H-T421-BM0-K
				1	XS5H-T421-CM0-K
				2	XS5H-T421-DM0-K
				3	XS5H-T421-EM0-K
				5	XS5H-T421-GM0-K
				10	XS5H-T421-JM0-K
				15	XS5H-T421-KM0-K
	Standard Cables	Cable with Plugs on Both Ends (M12 Straight/M12 Straight)	Light blue	0.5	XS5W-T421-BM2-K
				1	XS5W-T421-CM2-K
				2	XS5W-T421-DM2-K
				3	XS5W-T421-EM2-K
				5	XS5W-T421-GM2-K
				10	XS5W-T421-JM2-K
				15	XS5W-T421-KM2-K
			Yellow	0.3	XS5W-T421-AM2-Y
				0.5	XS5W-T421-BM2-Y
				1	XS5W-T421-CM2-Y
				2	XS5W-T421-DM2-Y
				3	XS5W-T421-EM2-Y
				5	XS5W-T421-GM2-Y
					Standard Cables
0.5	XS5W-T421-BMC-K				
1	XS5W-T421-CMC-K				
2	XS5W-T421-DMC-K				
3	XS5W-T421-EMC-K				
5	XS5W-T421-GMC-K				
10	XS5W-T421-JMC-K				
Yellow	0.3	XS5W-T421-AMC-Y			
	0.5	XS5W-T421-BMC-Y			
	1	XS5W-T421-CMC-Y			
	2	XS5W-T421-DMC-Y			
	3	XS5W-T421-EMC-Y			
	5	XS5W-T421-GMC-Y			
		Standard Cables	Cable with Plug on One End (M12 Right-angle)		
1				XS5H-T422-CM0-K	
2				XS5H-T422-DM0-K	
3				XS5H-T422-EM0-K	
5				XS5H-T422-GM0-K	
10				XS5H-T422-JM0-K	
15				XS5H-T422-KM0-K	
	Standard Cables	Cable with Plugs on Both Ends (M12 Right-angle/M12 Right-angle)	Light blue	0.5	XS5W-T422-BM2-K
				1	XS5W-T422-CM2-K
				2	XS5W-T422-DM2-K
				3	XS5W-T422-EM2-K
				5	XS5W-T422-GM2-K
				10	XS5W-T422-JM2-K
				15	XS5W-T422-KM2-K
	Standard Cables	Cable with Plugs on Both Ends (M12 Right-angle/RJ45)	Light blue	0.3	XS5W-T422-AMC-K
				0.5	XS5W-T422-BMC-K
				1	XS5W-T422-CMC-K
				2	XS5W-T422-DMC-K
				3	XS5W-T422-EMC-K
				5	XS5W-T422-GMC-K
				10	XS5W-T422-JMC-K
	Standard Cables	Cable with Plugs on Both Ends (RJ45/RJ45)	Light blue	0.3	XS5W-T421-AMD-K
				0.5	XS5W-T421-BMD-K
				1	XS5W-T421-CMD-K
				2	XS5W-T421-DMD-K
				3	XS5W-T421-EMD-K
				5	XS5W-T421-GMD-K
				10	XS5W-T421-JMD-K
15	XS5W-T421-KMD-K				



Appearance	Cable type	Type	Cable color	Cable length (m)	Model
	Standard Cables	Cable with Plug on One End and Socket on Other End (M12 Straight/M12 Straight)	Light blue	0.5	XS5W-T421-BM1-K
				1	XS5W-T421-CM1-K
				2	XS5W-T421-DM1-K
				3	XS5W-T421-EM1-K
				5	XS5W-T421-GM1-K
				10	XS5W-T421-JM1-K
	Standard Cables	Cable with Plug on One End and Socket on Other End (M12 Straight/RJ45)	Light blue	0.5	XS5W-T421-BME-K
				1	XS5W-T421-CME-K
				2	XS5W-T421-DME-K
				3	XS5W-T421-EME-K
				5	XS5W-T421-GME-K
				10	XS5W-T421-JME-K
	Robot Cables	Cable with Plug on One End and Socket on Other End (M12 Straight/M12 Straight)	Light blue	0.5	XS5W-T421-BM1-KR
				1	XS5W-T421-CM1-KR
				2	XS5W-T421-DM1-KR
				3	XS5W-T421-EM1-KR
				5	XS5W-T421-GM1-KR
				10	XS5W-T421-JM1-KR
	Robot Cables	Cable with Plugs on Both Ends (M12 Straight/M12 Straight)	Light blue	0.5	XS5W-T421-BM2-KR
				1	XS5W-T421-CM2-KR
				2	XS5W-T421-DM2-KR
				3	XS5W-T421-EM2-KR
				5	XS5W-T421-GM2-KR
				10	XS5W-T421-JM2-KR
	Robot Cables	Cable with Plugs on Both Ends (M12 Straight/RJ45)	Light blue	0.5	XS5W-T421-BMC-KR
				1	XS5W-T421-CMC-KR
				2	XS5W-T421-DMC-KR
				3	XS5W-T421-EMC-KR
				5	XS5W-T421-GMC-KR
				10	XS5W-T421-JMC-KR
	Robot Cables	Cable with Plugs on Both Ends (RJ45/RJ45)	Light blue	0.5	XS5W-T421-BMD-KR
				1	XS5W-T421-CMD-KR
				2	XS5W-T421-DMD-KR
				3	XS5W-T421-EMD-KR
				5	XS5W-T421-GMD-KR
				10	XS5W-T421-JMD-KR
	Robot Cables	Cable with Plugs on Both Ends (RJ45/RJ45)	Yellow	0.5	XS5W-T421-BMD-YR
				1	XS5W-T421-CMD-YR
				2	XS5W-T421-DMD-YR
				3	XS5W-T421-EMD-YR
				5	XS5W-T421-GMD-YR
					Shield Strengthening Cables
1	XS5W-T421-CM2-SS				
2	XS5W-T421-DM2-SS				
3	XS5W-T421-EM2-SS				
5	XS5W-T421-GM2-SS				
10	XS5W-T421-JM2-SS				
	Shield Strengthening Cables	Cable with Plugs on Both Ends (M12 Straight/RJ45)	Black	0.5	XS5W-T421-BMC-SS
				1	XS5W-T421-CMC-SS
				2	XS5W-T421-DMC-SS
				3	XS5W-T421-EMC-SS
				5	XS5W-T421-GMC-SS
				10	XS5W-T421-JMC-SS

Appearance	Cable type	Type	Cable color	Cable length (m)	Model	
	Standard Cables	RJ45 Assembly Connector	---	---	<b>XS6G-T421-1</b>	
		M12 Connector for Panel Mounting	Rear locking	---	0.5	<b>XS5P-T426-5</b>
			Front locking	---	0.5	<b>XS5P-T427-5</b>
	M12 Panel-mounting PCB Straight Terminals	---	---	<b>XS5P-T426-1</b>		

● **Cable Bending Data for Robot Cables (XS5W-T421-□M□-KR)**

The following data is the results of OMRON testing for cable bending test conditions. The number of bends may vary for your environment and application conditions.

**Cableveyor Test**

Number of bends: 20 million min.

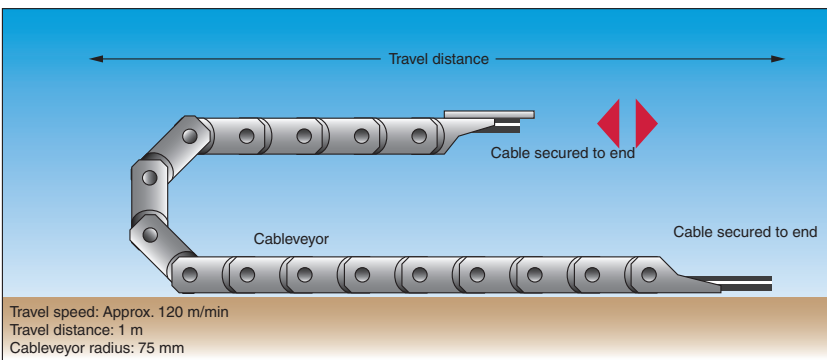

**90° Bending Test**

Number of bends: 6 million min.

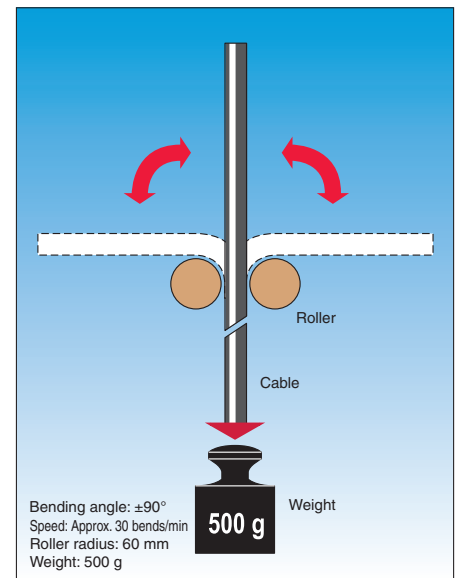

## Specifications

Type	Cable with Plug on One End (M12)	Cable with Plugs on Both Ends (M12/M12)	Cable with Plug on One End and Socket on Other End (M12/M12)	Cable with Plugs on Both Ends (M12/RJ45)	Cable with Plug on One End and Socket on Other End (M12/RJ45)	Cable with Plugs on Both Ends (RJ45/RJ45)	RJ45 Assembly Connector	M12 Connector for Panel Mounting	M12 Panel-mounting PCB Straight Terminals
Item Model	XS5H -T42□□M0-K	XS5W -T42□□M2-K, -KR	XS5W -T42□□M1-K, -KR	XS5W -T42□□MC-K, -KR	XS5W -T421□ME-K	XS5W -T421□MD-K, -KR	XS6G -T421-1	XS5P-T42□-5	XS5P -T426-1
Rated current	3 A			2.5 A			4 A		
Rated voltage	30 V							125 VDC	
Contact resistance	40 mΩ max.								
Insulation resistance	1,000 MΩ min.			500 MΩ min.			1,000 MΩ min.		
Withstand voltage	1,000 VAC for 60 s (leakage current: 1 mA max.)							1,500 VAC for 60 s (leakage current: 1 mA max.)	
Ambient operating temperature	-25 to 70°C*								
Ambient storage temperature	-25 to 70°C								
Protective structure	M12: IEC IP67, RJ45: IEC IP20								

\* Use the robot cable within a temperature range between 0°C and 70°C to prevent the wires inside the cable from being broken when bending it.

## Materials and Finish

### Connectors

Item	Model	M12			RJ45
		XS5H and XS5W	XS5P-T42□-5	XS5P-T426-1	XS5W and XS6G
Contact blocks	PBT resin (UL94V-0)/light gray		PA resin (UL94V-0)/black		PA resin (UL94V-0)/black
Contacts	Phosphor bronze/nickel base, gold plated (0.4 μm)			Brass/nickel base, gold plated (0.4 μm)	Phosphor bronze/nickel base, gold plated (1.4 μm)
Anchors	Zinc diecast/nickel plating				---
Anchors (tabs)	SUS	---			
Cover	TPE (Thermo Plastic Elastomer) /black	---			
Sealing resin	---	Epoxy resin	---		
O-rings	Rubber				---
Grounding fixture	---	Phosphor bronze/nickel base, tin plated (2.0 μm)		---	
Anchor cover	---	SUS		---	
Nuts	---	Brass/nickel plated			---

### Cables

Item	Model	Standard Cables	Robot Cables	Shield Strengthening Cables
Compliant standard	UL CM			
Category	Category 5e			
Core/color	AWG22 (7/0.26): Yellow · Orange · White · Blue	AWG22 (7/24/0.05): Yellow · Orange · White · Blue	AWG22 (7/0.26): Yellow · Orange · White · Blue	
Outer diameter*1	6.5 dia.			
Sheath color*2	Light blue, Yellow		Black	
Sheath material	PVC			
Shield structure	Double shield SF/UTP			

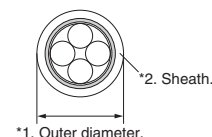

Note. For the XS5H and XS5W, cables are available only with connectors attached.

## ■ Dimensions

(Unit: mm)

### ● Cable with Plug on One End (M12 Straight)

XS5H-T421-□M0-K

#### Wiring

Terminal No.	Color
1	Yellow
2	White
3	Orange
4	Blue

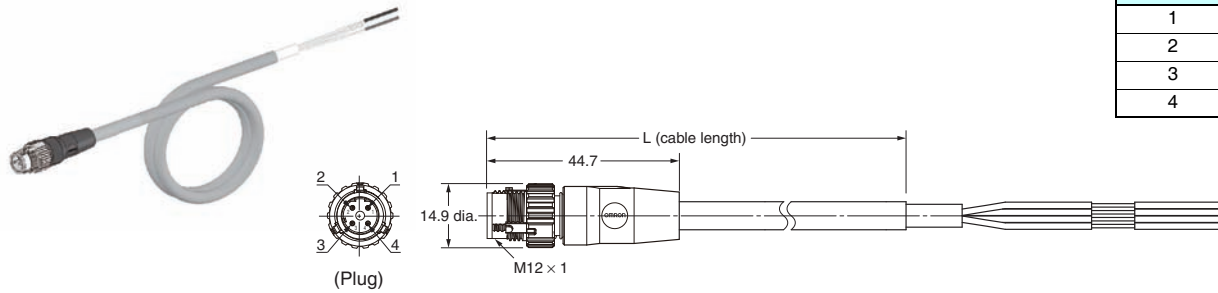

### ● Cable with Plugs on Both End (M12 Straight/M12 Straight)

XS5W-T421-□M2-K  
 XS5W-T421-□M2-KR  
 XS5W-T421-□M2-Y  
 XS5W-T421-□M2-YR

#### Wiring

M12 straight	M12 straight
1	1
2	2
3	3
4	4
Shield	Shield

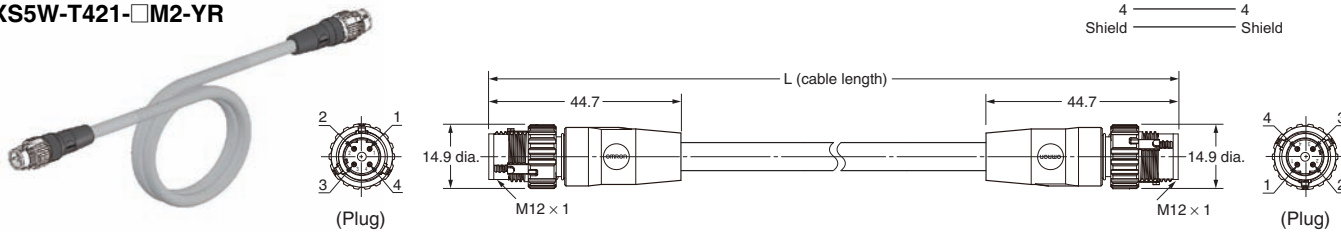

### ● Cable with Plugs on Both Ends (M12 Straight/RJ45)

XS5W-T421-□MC-K  
 XS5W-T421-□MC-KR  
 XS5W-T421-□MC-Y  
 XS5W-T421-□MC-YR

#### Wiring

M12 straight	RJ45
1	1
2	3
3	2
4	6
Shield	Shield

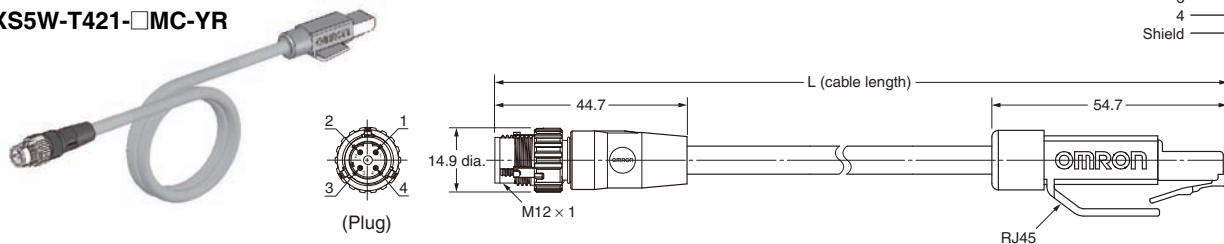

### ● Cable with Plug on One End and Socket on Other End (M12 Straight/M12 Straight)

XS5W-T421-□M1-K  
 XS5W-T421-□M1-KR

#### Wiring

M12 straight	M12 straight
1	1
2	2
3	3
4	4
Shield	Shield

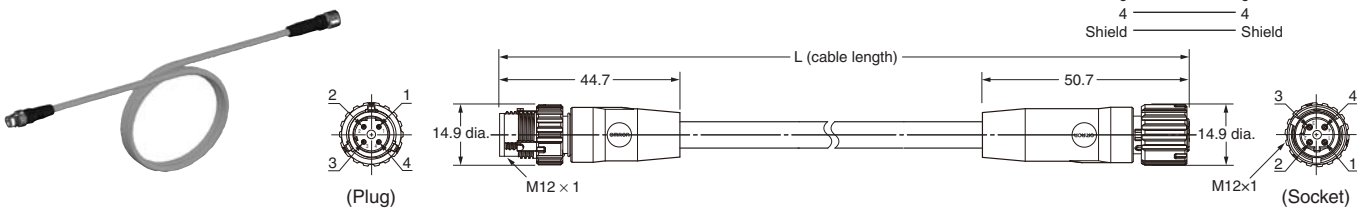

### ● Cable with Plug on One End and Socket on Other End (M12 Straight/RJ45)

XS5W-T421-□ME-K

#### Wiring

M12 straight	RJ45
1	1
2	3
3	2
4	6
Shield	Shield

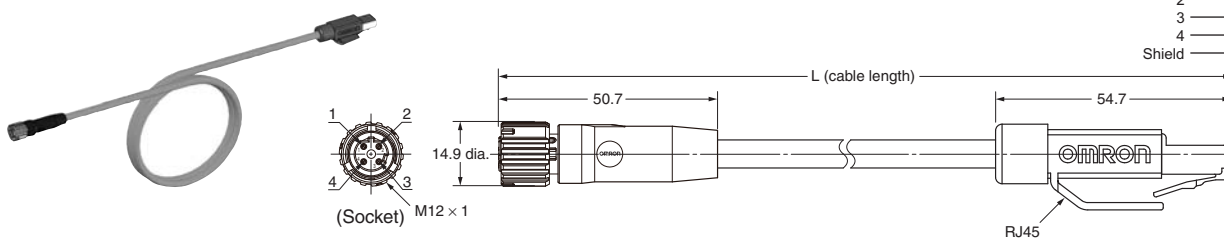

● Cable with Plug One End (M12 Right-angle)  
XS5H-T422-□M0-K

**Wiring**

Terminal No.	Color
1	Yellow
2	White
3	Orange
4	Blue

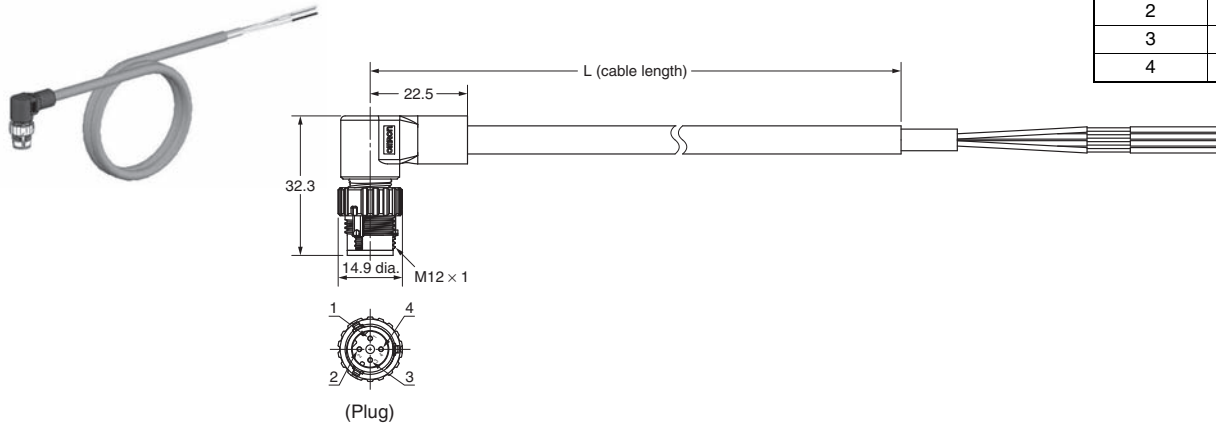

● Cable with Plugs on Both Ends (M12 Right-angle/M12 Right-angle)  
XS5W-T422-□M2-K

**Wiring**

M12 right angle	M12 right angle
1	1
2	2
3	3
4	4
Shield	Shield

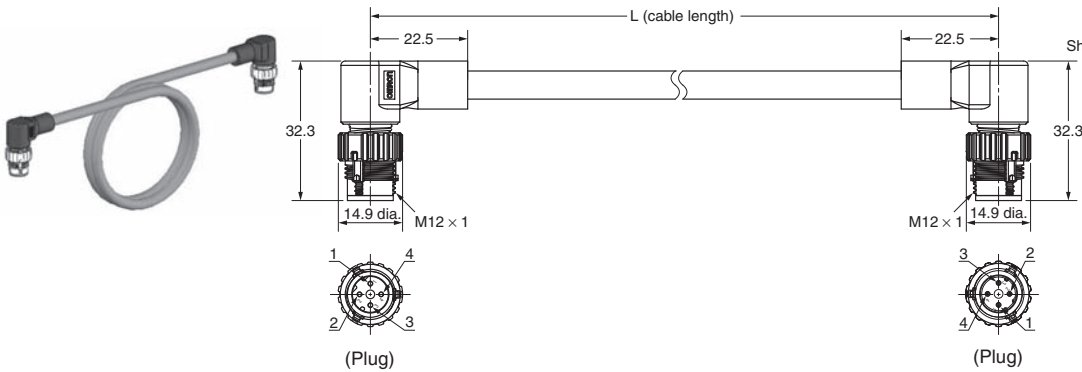

● Cable with Plugs on Both Ends (M12 Right-angle/RJ45)  
XS5W-T422-□MC-K

**Wiring**

M12 right angle	RJ45
1	1
2	3
3	2
4	6
Shield	Shield

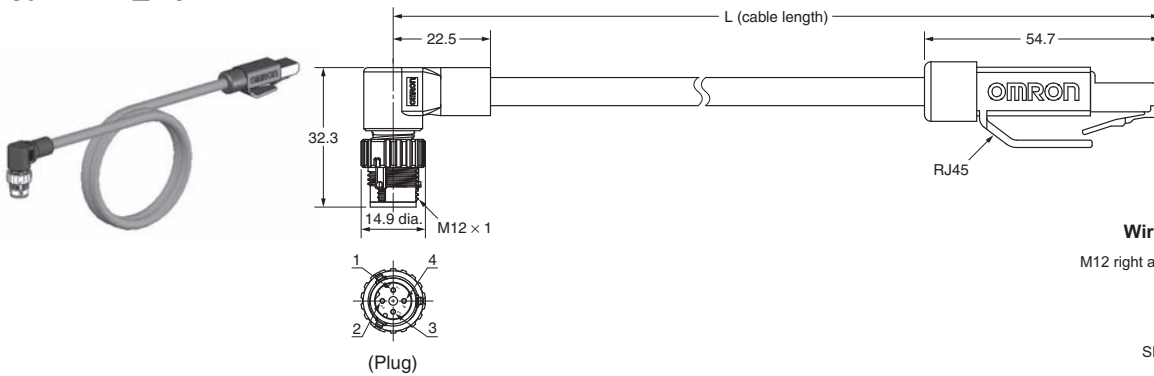

● Cable with Plugs on Both Ends (RJ45/RJ45)

XS5W-T421-□MD-K  
 XS5W-T421-□MD-KR  
 XS5W-T421-□MD-YR

Wiring

RJ45		RJ45
1	————	1
2	————	2
3	————	3
6	————	6
Shield	————	Shield

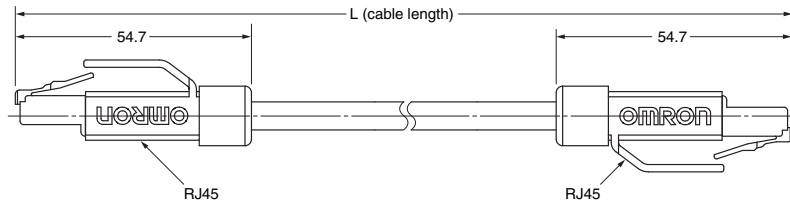

● Cable with Plugs on Both Ends (M12 Straight/M12 Straight)

Shield Strengthening Cable  
 XS5W-T421-□M2-SS

Wiring

M12 straight		M12 straight
1	————	1
2	————	2
3	————	3
4	————	4
Shield	————	Shield

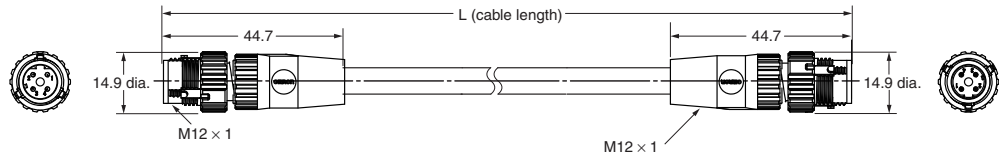

● Cable with Plugs on Both Ends (M12 Straight/RJ45)

Shield Strengthening Cable  
 XS5W-T421-□MC-SS

Wiring

M12 straight		RJ45
1	————	1
2	————	3
3	————	2
4	————	6
Shield	————	Shield

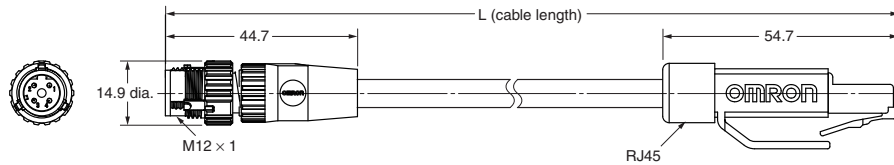

## ● RJ45 Assembly Connector XS6G-T421-1

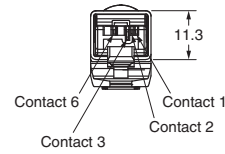
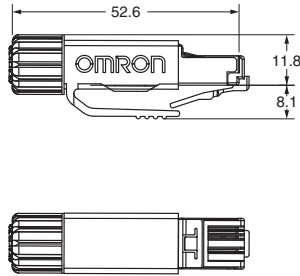

### Applicable wires

Sheath outer diameter: 6.1 to 6.9 mm  
 Core size: AWG22 to AWG24 (stranded wires)  
 AWG22 to AWG23 (solid wires)  
 Insulation outer diameter: 1.6 mm max.

## ● M12 Connector for Panel Mounting XS5P-T42□-5



### XS5P-T426-5 (Rear Locking)

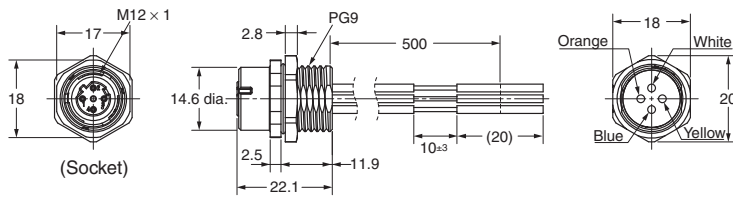

### XS5P-T427-5 (Front Locking)

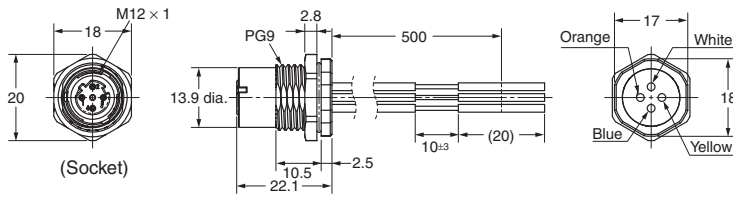

### Wiring

Terminal No.	Color
1	Yellow
2	White
3	Orange
4	Blue

### Panel Cutout Dimension

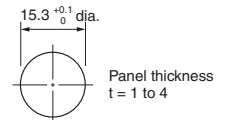

Note 1: The panel cutout dimension is the same for Front-locking and Rear-locking Connectors.

Note 2: Rotational positioning is not possible for connector rotation.

## ● M12 Panel-mounting PCB Straight Terminals XS5P-T426-1

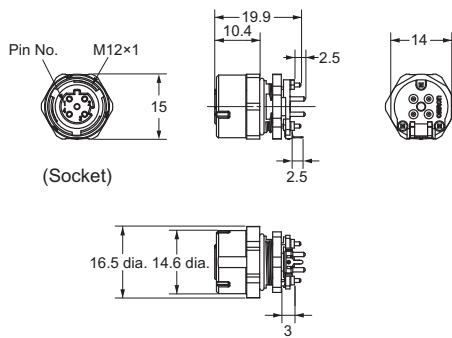

### Mounting Hole Dimensions (D Cut Structure)

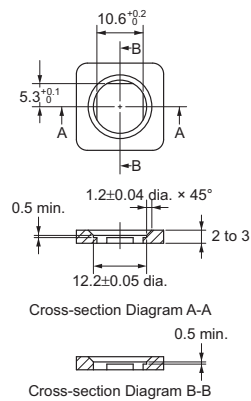

### Mounting Hole Dimensions (D Cut Structure)

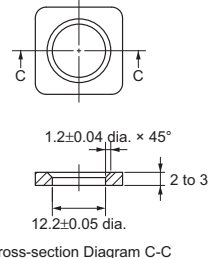

### Panel Processing Dimensions

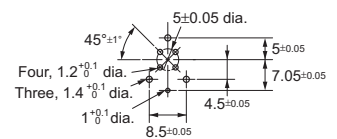

## Assembly Procedure

### ● RJ45 Assembly Connectors

#### XS6G-T421-1

1. Pass the cable through the cable clamp and the connector housing
2. Strip the cable sheath and ground braiding to the correct lengths.
3. Follow the color codes and prepare to insert the wires into the splice piece.
4. Insert the wires into the splice piece for the length of the splice piece.
5. Place the splice piece into the RJ45 data module and engage it.
6. Place the data module and the splice piece on the IDC assembly housing.
7. Press the data module and the IDC assembly housing together and use pliers or a similar device to make the insulation displacement contact.
8. Remove the data module from the IDC assembly housing.
9. Place the upper screen plate on the data module and press it over the ground braiding of the cable.
10. Place the lower screen plate on the bottom of the data module, align it with the upper screen plate, and latch it until you hear it click into place.
11. Slide the housing that you placed around the cable in step 1 up to the data module and latch it until you hear it click into place.
12. Tighten the cable clamp.



### Pin Assignments

Pin Assignments for Fast Ethernet 10/100 Mbps

Function/Signal	Wire color			Pin No.
	Industrial Ethernet	EIA/TIA 568A	EIA/TIA 568B	
Transmission Data+/TD+	YE	WH/GN	WH/OG	1
Transmission Data-/TD-	OG	GN	OG	2
Receiver Data/RD+	WH	WH/OG	WH	3
Receiver Data/RD-	BU	OG	GN	6

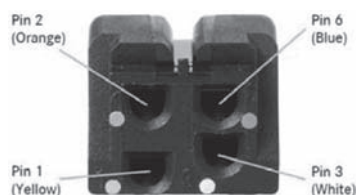

### ● M12 Panel-mounting PCB Straight Terminals

#### XS5P-T426-1

#### Confirming the Number of Parts

The following four parts are included in the package when it is delivered.

#### Panel-mounting Parts

1. Anchor

2. O-Ring

3. Nut

#### PCB-mounting Part

4. Connector



#### Assembly Procedure

1. Mount the connector to the PCB.

2. Attach the anchor to the panel with the nut.

Mounting the Connector to the PCB

Mounting the Anchor to the Panel

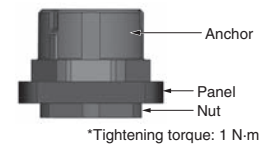
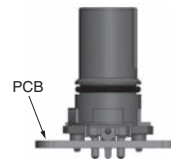

3. Attach the connector that you mounted to the PCB to the panel.

\* Make sure that the connector and anchor are oriented correctly.

Attachment

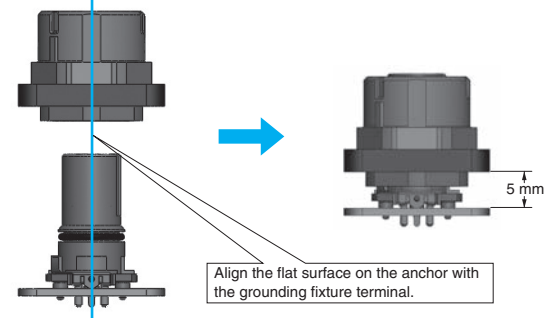

4. Temporarily mount the O-ring to the top of the connector at the mating surface.

Temporary Mounting of the O-Ring

O-ring



5. Mate the Connector Waterproof Cover (XS2Z-22, sold separately) or the Partner Connector Plug (XS5H-T42□-□M0-K, sold separately) and press the O-ring to the O-ring position after mounting.

Mounting the O-Ring

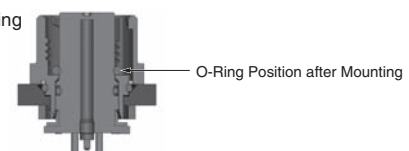

### ● Connector Waterproof Cover (Sold Separately)

#### XS2Z-22



\* Tightening torque: 0.39 to 0.49 N·m



## ■ Safety Precautions

### Precautions for Correct Use

Do not use the Connectors in an atmosphere or environment that exceeds the specifications.

#### ● Connector Connection and Disconnection

- When connecting or disconnecting Connectors, be sure to hold the Connectors.
- Do not hold the cable when disconnecting Connectors.
- When joining Connectors, be sure to insert the plug all the way to the back of the socket before attempting to lock the Connectors.
- Do not use tools of any sort to join the Connectors. Always use your hands. Pliers or other tools may damage the Connectors.

#### ● Wiring

Lay the cables so that external force is not applied to the Connectors. Otherwise, the degree of protection (IP67) may not be achieved.

#### ● Degree of Protection for M12/Smartclick Connectors

- The degree of protection of Connectors (IP67) is not for a fully watertight structure. Do not use the Connectors underwater.
- Do not step on or place any objects on the Connectors. Doing so may damage the Connectors.

#### ● Handling Precautions

- Do not pull on the Connectors or cables with excessive force.  
Do not install the Connectors with a load placed directly on the joint or at the point where the wires connect to the Connector. The Connector may be damaged or the wires in the cable may be disconnected.
- Lay the cable where it will not be stepped on to prevent the wires in the cable from being disconnected and to protect the Connectors from being damaged. If the cable must be placed where it will be stepped on, install a protective cover.
- When bending cables, do not exceed the cable specifications.

**OMRON Corporation** Industrial Automation Company  
Kyoto, JAPAN

Contact: [www.ia.omron.com](http://www.ia.omron.com)

**Regional Headquarters**

**OMRON EUROPE B.V.**

Wegalaan 67-69, 2132 JD Hoofddorp  
The Netherlands

Tel: (31)2356-81-300/Fax: (31)2356-81-388

**OMRON ELECTRONICS LLC**

2895 Greenspoint Parkway, Suite 200  
Hoffman Estates, IL 60169 U.S.A.

Tel: (1) 847-843-7900/Fax: (1) 847-843-7787

**OMRON ASIA PACIFIC PTE. LTD.**

No. 438A Alexandra Road # 05-05/08 (Lobby 2),  
Alexandra Technopark,  
Singapore 119967

Tel: (65) 6835-3011/Fax: (65) 6835-2711

**OMRON (CHINA) CO., LTD.**

Room 2211, Bank of China Tower,  
200 Yin Cheng Zhong Road,  
PuDong New Area, Shanghai, 200120, China

Tel: (86) 21-5037-2222/Fax: (86) 21-5037-2200

**Authorized Distributor:**

© OMRON Corporation 2010-2017 All Rights Reserved.  
In the interest of product improvement,  
specifications are subject to change without notice.

**CSM\_9\_5\_0318**  
**Cat. No. G019-E1-07**

Printed in Japan  
0317 (0710)