

Digital Fiber Sensor

FX-500 SERIES Ver.2

- FIBER SENSORS
- LASER SENSORS
- PHOTOELECTRIC SENSORS
- MICRO PHOTOELECTRIC SENSORS
- AREA SENSORS
- LIGHT CURTAINS / SAFETY COMPONENTS
- PRESSURE / FLOW SENSORS
- INDUCTIVE PROXIMITY SENSORS
- PARTICULAR USE SENSORS
- SENSOR OPTIONS
- SIMPLE WIRE-SAVING UNITS
- WIRE-SAVING SYSTEMS
- MEASUREMENT SENSORS
- STATIC ELECTRICITY PREVENTION DEVICES
- LASER MARKERS
- PLC
- HUMAN MACHINE INTERFACES
- ENERGY CONSUMPTION VISUALIZATION COMPONENTS
- FA COMPONENTS
- MACHINE VISION SYSTEMS
- UV CURING SYSTEMS

Related Information

- General terms and conditions..... F-7
- Sensor selection guide..... P.3~
- Fiber selection..... P.5~
- Glossary of terms..... P.1455~
- General precautions P.1458~

Ver.2



* There is no change in Model No. and price due to version upgrade.
* Cover opened state is shown.

panasonic.net/id/pidsx/global

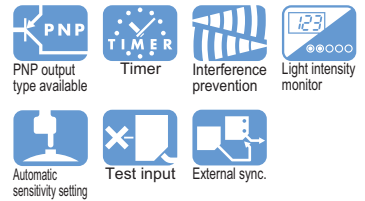
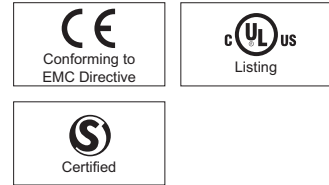

At the industry's leading edge

Improved the operability and visibility of the operation keys

Operation keys (setting switch and MODE key) have been renewed to be easy to operate. Also, the color of the keys has been changed from black to light gray to achieve good visibility in dim light.

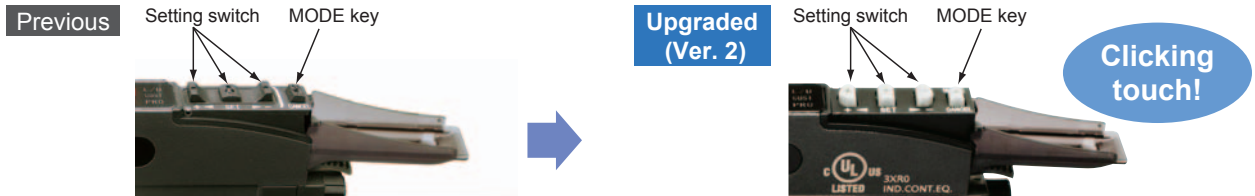

High stability!

When the FX-500 series is used together with our super quality fiber, the incident light intensity variation among units is decreased to only 1/4 of that of conventional models.

By being close to absolute values instead of modified digital values, changes in detection that could not be found in the past can now be monitored.

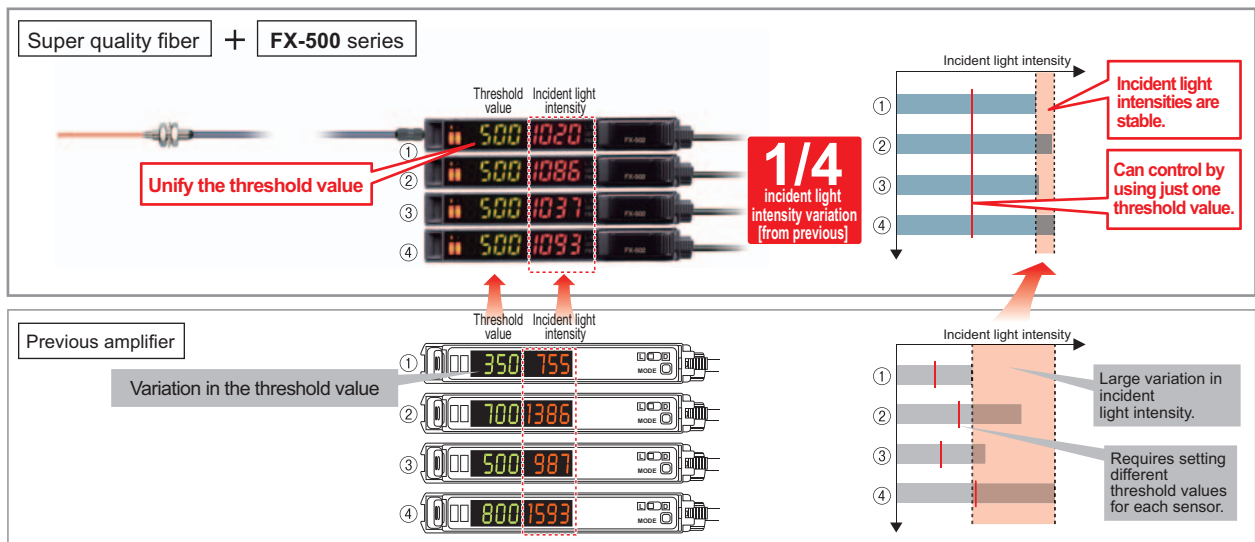

- Selection Guide
- Fibers
- Fiber Amplifiers

- FX-500
- FX-100
- FX-300
- FX-410
- FX-311
- FX-301-F7/ FX-301-F

A quality that surpassed that of standard fibers!

New fibers developed using a new manufacturing method adopted by our own factory along with a persistent quality control system.
The basic performance of a standard fiber is greatly enhanced!

Stable emission amount $\updownarrow \pm 10$

Variation in emission amount of the fiber core is controlled down to less than $\pm 10\%$, achieving a stable detection.

- Beam axis deviation: Thru-beam type within $\pm 2^\circ$, Reflective type within $\pm 3^\circ$
- Beam axis centering precision: within $\pm 150\ \mu\text{m}$

$\phi 2.2\ \text{mm}$ $\phi 0.087\ \text{in}$ standard fiber

New material
Single core standard fiber with high flexibility

Previous
In general, high-flexibility types adopt a multi-fiber core, which may result in large variation in light emission.

Expanded temperature range

Ambient temperature [-40 to $+70^\circ\text{C}$ / -40 to $+158^\circ\text{F}$ in previous model]

-55 to $+80^\circ\text{C}$
 -67 to $+176^\circ\text{F}$

1.2 times more than previous model

More flexible! **R4**

Bending radius [Previous model is $R25\ \text{mm}$ / $R0.984\ \text{in}$]

R4 mm
R0.157 in

1/6 of that of previous model

Integrated high-precision plug

The centering precision of the fiber core attached to the inserting plug is doubled. As the insertion precision is increased, the variation among units can be greatly suppressed.

- Centering precision: within $\pm 40\ \mu\text{m}$

More bendable!

Bending durability [Previous model is 1,000 times]

10 million times

10,000 times more than previous model

* Bending conditions
Bending radius: $R10\ \text{mm}$ / $R0.394\ \text{in}$,
Reciprocating bending 180°

Max. 25 μs response time

FX-500 with its high response time contributes to improve productivity.

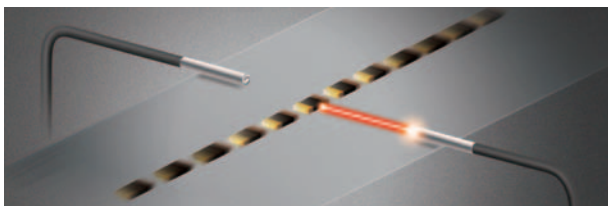

Performing minute object detection when using a small diameter fiber is now possible with a high response time and longer sensing range.

Hyper **HYPR** mode incorporated

FX-500 in combination with small diameter fibers which can handle challenging detections, allows long sensing range.

Tough **FX-500 HYPR mode** **FD-41**

Previous **FX-301 (LONG mode)** **FD-NFM2**

Max. 5.7 times! (Note) longer than the previous model

Note: When using **FD-NFM2**.

So accurate! Sharp detection with suppressed hysteresis

FX-500 with its accurate detection catches fractional differences in light intensity, achieving high precision and solving low-hysteresis applications.

- Long range detection of small objects with small difference in light intensity **H-02 mode**

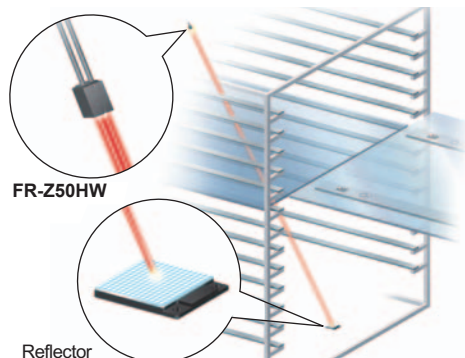

- Highly accurate detection while avoiding saturation **H-01 mode**

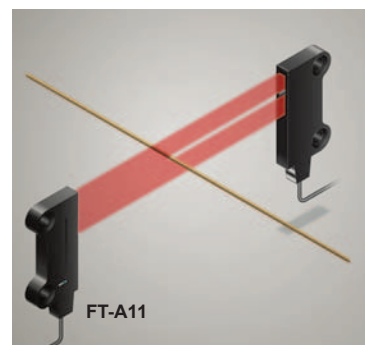

FIBER SENSORS

LASER SENSORS

PHOTOELECTRIC SENSORS

MICRO PHOTOELECTRIC SENSORS

AREA SENSORS

LIGHT CURTAINS / SAFETY COMPONENTS

PRESSURE / FLOW SENSORS

INDUCTIVE PROXIMITY SENSORS

PARTICULAR USE SENSORS

SENSOR OPTIONS

SIMPLE WIRE-SAVING UNITS

WIRE-SAVING SYSTEMS

MEASUREMENT SENSORS

STATIC ELECTRICITY PREVENTION DEVICES

LASER MARKERS

PLC

HUMAN MACHINE INTERFACES

ENERGY CONSUMPTION VISUALIZATION COMPONENTS

FA COMPONENTS

MACHINE VISION SYSTEMS

UV CURING SYSTEMS

Selection Guide

Fibers

Fiber Amplifiers

FX-500

FX-100

FX-300

FX-410

FX-311

FX-301-F7/ FX-301-F

FIBER SENSORS

LASER SENSORS

PHOTOELECTRIC SENSORS

MICRO PHOTOELECTRIC SENSORS

AREA SENSORS

LIGHT CURTAINS / SAFETY COMPONENTS

PRESSURE / FLOW SENSORS

INDUCTIVE PROXIMITY SENSORS

PARTICULAR USE SENSORS

SENSOR OPTIONS

SIMPLE WIRE-SAVING UNITS

WIRE-SAVING SYSTEMS

MEASUREMENT SENSORS

STATIC ELECTRICITY PREVENTION DEVICES

LASER MARKERS

PLC

HUMAN MACHINE INTERFACES

ENERGY CONSUMPTION VISUALIZATION COMPONENTS

FA COMPONENTS

MACHINE VISION SYSTEMS

UV CURING SYSTEMS

Selection Guide

Fibers

Fiber Amplifiers

FX-500

FX-100

FX-300

FX-410

FX-311

FX-301-F7/ FX-301-F

Flat display with wide viewing angle

The large and high-contrast 7-segment display of high luminance provides clear visibility from a wide angle of view.

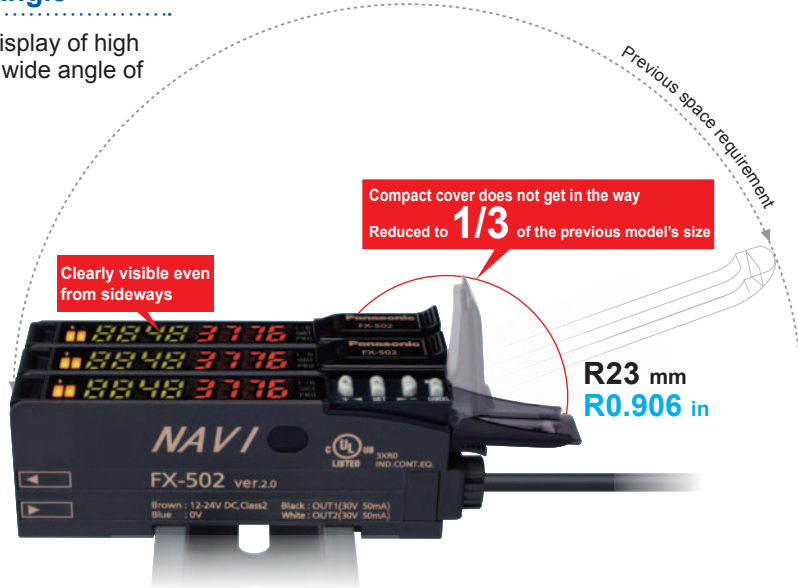

Resolves variation in displayed incident light intensity Display adjustment setting

The variation in display can be adjusted to random values. This helps to define proper instruction in a work order.

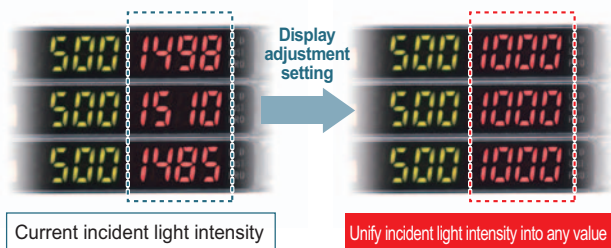

Stable detection over long and short periods Stabilized emission amount

The “four-chemical emitting element”, which we are the first to incorporate to maintain a stable level of light emission, has now become an industry standard. **FX-500** series continues to adopt the same emitting element as well as the “APC (Auto Power Control) circuit” which improves stability in short periods such as when the power is turned on.

Saves maintenance time Threshold tracking function

This function performs automatic setting to threshold value by checking the incident light intensity at desired intervals in order to follow the changes in the light amount resulting from changes in the environment over long periods (such as dust). This contributes to reduction in maintenance hours.

Suitable for preventative maintenance Self-diagnosis output

FX-502(P)
FX-505(P)-C2

FX-502(P) / 505(P)-C2 can set Output 2 as a self-diagnosis output. When the teaching of Output 1's threshold value is carried out, Output 2 is set concurrently with the setting randomly shifted by the amount of surplus of threshold value. Light intensity deterioration due to fiber breakage or dust accumulation can be notified as an alarm output.

- Detect deterioration in light intensity (e.g. Useful in dusty environment)

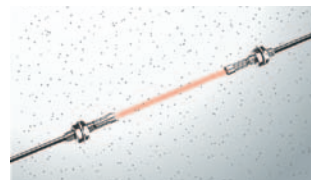

Self-diagnosis can be used with the threshold tracking function for added effectiveness.

Stable detection while being eco-friendly Emission power & gain setting

In cases when the incident light intensity is saturated, the light emitting amount can be adjusted to the optimal level by AUTO without changing the response time. This allows stable detection with an optimal S/N ratio and saves energy by controlling the emitting electric current.

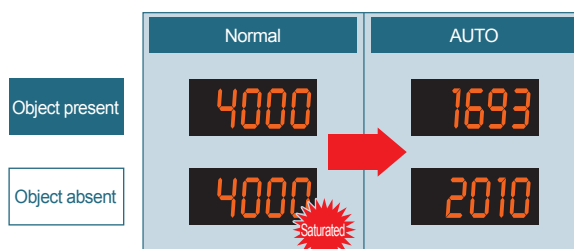

Auto mode (AUTO) and 3-level manual mode (H / M / L [fine-adjustable]) are incorporated.

- Detecting a transparent sheet

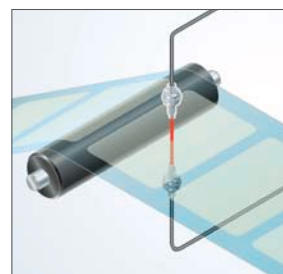

Built-in logic functions No PLC necessary, saving material and programming costs

Logical calculation functions

3 logical calculations (AND, OR, XOR) are available with fiber sensor only. 3 logical operations can be selected against Output 1. Additional controller is not required so both wire-saving and cost reduction can be achieved.

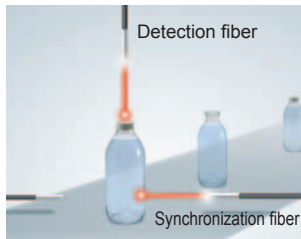

Calculation of two neighboring amplifiers

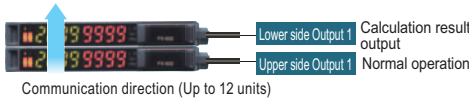

Calculation of two outputs in one amplifier **FX-502(P) / 505(P)-C2**



Calculation of one amplifier and external input **FX-502(P) / 505(P)-C2**



Equipped with 5 timer types

A wide variety of timer control operations can be carried out by fiber sensors only.

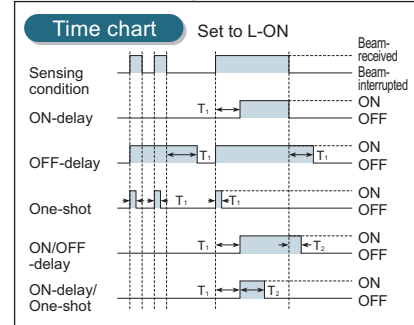

Timer period: 0.05 ms to 32 s
Output 1 has ON / OFF-delay and ON-delay / One-shot timers are available.

Analog output cable type **FX-505(P)-C2**

To monitor the sensing of objects, a 4 to 20 mA analog current is output in respond to the digital value of the incident light intensity.

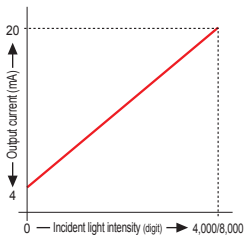

Edge tracking of film or sheet

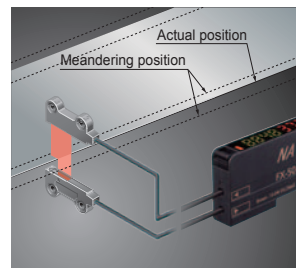

The meandering path can be monitored as the light intensity changes.

Smooth setup changes by 8 data banks

The number of data banks used for saving the setup conditions of the amplifier is increased to eight. Setup conditions can be saved and loaded to make setup changes easy at a worksite where multiple models are manufactured.

Remote control improves work efficiency by external input **FX-502(P) / FX-505(P)-C2**

Work efficiency can be improved by operating via PLC output or other external signal. (FX-502(P) can operate via external signal when switching from Output 2 to external input.)

Functions operable by external input

Full-auto / Limit / 2-point teaching	Display adjustment setting
Data bank load / save	Logical calculation (self-unit only)
Emission halt	Copying function lock (self-unit only)

An optical communication function allows sensors to be adjusted simultaneously

The data that is currently set can be copied and saved all at once for all amplifiers connected together from the right side thanks to the optical communication function. This greatly reduces troublesome setup tasks and makes setup much smoother.

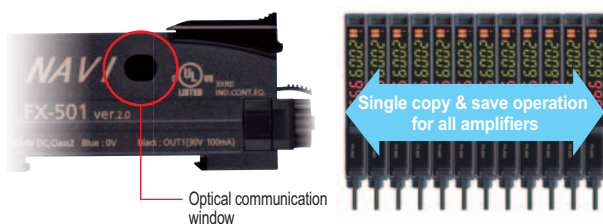

No need to specify a main unit or sub unit

All FX-500 amplifiers can be used as either a main unit or a sub unit. Just use a main cable or a sub cable to distinguish the two. This reduces the costs of inventory management.

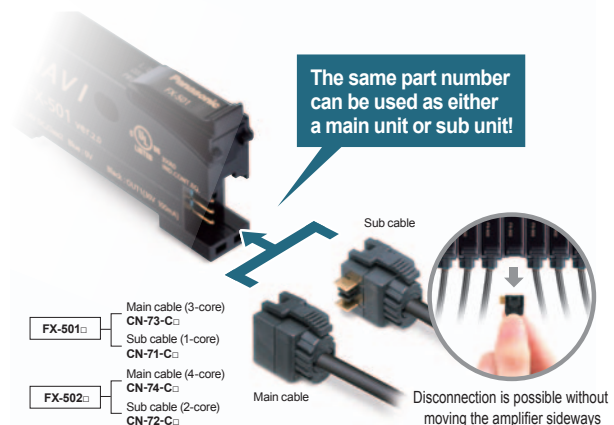

- FX-501**
 - Main cable (3-core) CN-73-C
 - Sub cable (1-core) CN-71-C
 - FX-502**
 - Main cable (4-core) CN-74-C
 - Sub cable (2-core) CN-72-C
- Disconnection is possible without moving the amplifier sideways

FIBER SENSORS

LASER SENSORS

PHOTOELECTRIC SENSORS

MICRO PHOTOELECTRIC SENSORS

AREA SENSORS

LIGHT CURTAINS / SAFETY COMPONENTS

PRESSURE / FLOW SENSORS

INDUCTIVE PROXIMITY SENSORS

PARTICULAR USE SENSORS

SENSOR OPTIONS

SIMPLE WIRE-SAVING UNITS

WIRE-SAVING SYSTEMS

MEASUREMENT SENSORS

STATIC ELECTRICITY PREVENTION DEVICES

LASER MARKERS

PLC

HUMAN MACHINE INTERFACES

ENERGY CONSUMPTION VISUALIZATION COMPONENTS

FA COMPONENTS

MACHINE VISION SYSTEMS

UV CURING SYSTEMS

Selection Guide

Fibers

Fiber Amplifiers

FX-500

FX-100

FX-300

FX-410



FX-311

FX-301-F7 / FX-301-F

ORDER GUIDE

Amplifiers

Quick-connection cable is not supplied with **FX-501(P)** and **FX-502(P)**. Please order it separately.

Type	Appearance	Model No.	Emitting element	Output	External input
Standard type		FX-501	Red LED	NPN open-collector transistor	—
		FX-501P		PNP open-collector transistor	
2-output type		FX-502		NPN open-collector transistor 2 outputs	Incorporated (Switchable with Output 2)
		FX-502P		PNP open-collector transistor 2 outputs	
Cable type		FX-505-C2		NPN open-collector transistor 2 outputs analog output	Incorporated
		FX-505P-C2		PNP open-collector transistor 2 outputs analog output	

Quick-connection cables

For FX-501(P)

Quick-connection cable is not supplied with the amplifier. Please order it separately.

Type	Model No.	Description	
Main cable (3-core)	CN-73-C1	Length: 1 m 3.281 ft	0.2 mm ² 3-core cabtyre cable, with connector on one end Cable outer diameter: ø3.3 mm ø0.130 in
	CN-73-C2	Length: 2 m 6.562 ft	
	CN-73-C5	Length: 5 m 16.404 ft	
Sub cable (1-core)	CN-71-C1	Length: 1 m 3.281 ft	0.2 mm ² 1-core cabtyre cable, with connector on one end Cable outer diameter: ø3.3 mm ø0.130 in Connectable to a main cable up to 15 cables.
	CN-71-C2	Length: 2 m 6.562 ft	
	CN-71-C5	Length: 5 m 16.404 ft	

Main cable

- **CN-73-C□**

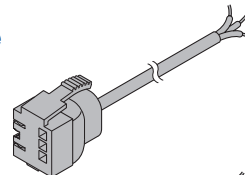

Sub cable

- **CN-71-C□**

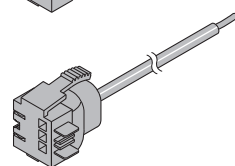

For FX-502(P)

Quick-connection cable is not supplied with the amplifier. Please order it separately.

Type	Model No.	Description	
Main cable (4-core)	CN-74-C1	Length: 1 m 3.281 ft	0.2 mm ² 4-core cabtyre cable, with connector on one end Cable outer diameter: ø3.3 mm ø0.130 in
	CN-74-C2	Length: 2 m 6.562 ft	
	CN-74-C5	Length: 5 m 16.404 ft	
Sub cable (2-core)	CN-72-C1	Length: 1 m 3.281 ft	0.2 mm ² 2-core cabtyre cable, with connector on one end Cable outer diameter: ø3.3 mm ø0.130 in Connectable to a main cable up to 15 cables.
	CN-72-C2	Length: 2 m 6.562 ft	
	CN-72-C5	Length: 5 m 16.404 ft	

Main cable

- **CN-74-C□**

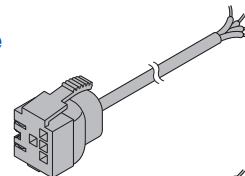

Sub cable

- **CN-72-C□**

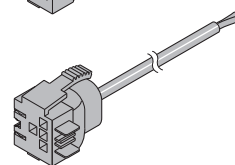

End plates

End plates are not supplied with the amplifier. Please order them separately when the amplifiers are mounted in cascade.

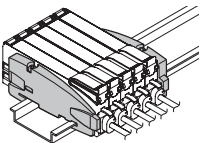
Appearance	Model No.	Description
	MS-DIN-E	When amplifiers are mounted in cascade, or when an amplifier moves depending on the way it is installed on a DIN rail, these end plates clamp amplifiers into place on both sides. Make sure to use end plates when cascading multiple amplifiers together. Two pcs. per set

OPTIONS

Designation	Model No.	Description
Amplifier mounting bracket	MS-DIN-2	Mounting bracket for amplifier

Amplifier mounting bracket

- MS-DIN-2

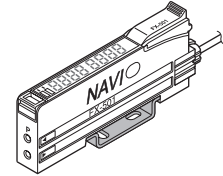

Accessory

- **FX-MB1** (Amplifier protection seal)
10 sets of 2 communication window seals and 1 connector seal

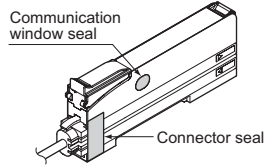

LIST OF FIBERS

Super quality

Thru-beam type (one pair set)

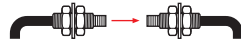

Type	Shape of fiber head (mm)	Model No.	Bending radius (mm)	Fiber cable length	Sensing range (mm in)		Beam axis dia. (mm)	Beam axis position / Inclination of beam axis	Optical transmission loss	Protection	Ambient temp.	Dimensions
					FX-500 series	U-LG LONG FAST H-SP						
Threaded	M3	Tough FT-30	R2 Bending durability	2 m	STD 400 15.748 HYPR 1,350 53.150	810 31.890 650 25.591 210 8.268 75 2.953	0.5	150 μm / ±2°	±10 %	IP67	-55 to +80 °C	P.51
	M4	Tough FT-40	R4 Bending durability		STD 1,200 47.244 HYPR (Note) 3,600 141.732	2,200 86.614 1,700 66.929 530 20.866 190 7.480						
Cylindrical	ø1.5	Tough FT-S20	R2 Bending durability		STD 400 15.748 HYPR 1,350 53.150	810 31.890 650 25.591 210 8.268 75 2.953	0.5					
	ø3	Tough FT-S30	R4 Bending durability		STD 1,200 47.244 HYPR (Note) 3,600 141.732	2,200 86.614 1,700 66.929 530 20.866 190 7.480						

Note: The fiber cable length practically limits the sensing range.

Reflective type



Type	Shape of fiber head (mm)	Model No.	Bending radius (mm)	Fiber cable length	Sensing range (mm in) (Note)		Beam axis position / Inclination of beam axis	Optical transmission loss	Protection	Ambient temp.	Dimensions
					FX-500 series	U-LG LONG FAST H-SP					
Threaded	M3	Tough FD-30	R2 Bending durability	2 m	STD 160 6.299 HYPR 600 23.622	330 12.992 250 9.843 80 3.150 25 0.984	150 μm / ±3°	±10 %	IP67	-55 to +80 °C	P.59
	M4	Tough FD-40	R4 Bending durability		STD 520 20.472 HYPR 1,550 61.024	900 35.433 740 29.134 260 10.236 90 3.543					
	M6	Tough FD-60			STD 160 6.299 HYPR 600 23.622	330 12.992 250 9.843 80 3.150 25 0.984					
Cylindrical	ø3	Tough FD-S30	R4 Bending durability		STD 160 6.299 HYPR 600 23.622	330 12.992 250 9.843 80 3.150 25 0.984					P.67

Note: The sensing range is specified for white non-glossy paper.

Tough : Refers to a fiber which possesses both unbreakable (bending radius: R10 mm R0.394 in, reciprocating bending: 180°) and more flexible (bending radius: R4 mm R0.157 in or less) features.

FIBER SENSORS

LASER SENSORS

PHOTO-ELECTRIC SENSORS

MICRO PHOTO-ELECTRIC SENSORS

AREA SENSORS

LIGHT CURTAINS / SAFETY COMPONENTS

PRESSURE / FLOW SENSORS

INDUCTIVE PROXIMITY SENSORS

PARTICULAR USE SENSORS

SENSOR OPTIONS

SIMPLE WIRE-SAVING UNITS

WIRE-SAVING SYSTEMS

MEASUREMENT SENSORS

STATIC ELECTRICITY PREVENTION DEVICES

LASER MARKERS

PLC

HUMAN MACHINE INTERFACES

ENERGY CONSUMPTION VISUALIZATION COMPONENTS

FA COMPONENTS

MACHINE VISION SYSTEMS

UV CURING SYSTEMS

Selection Guide

Fibers

Fiber Amplifiers

FX-500

FX-100

FX-300

FX-410

FX-311

FX-301-F7/
FX-301-F

LIST OF FIBERS

Threaded type

Thru-beam type (one pair set)



Type	Shape of fiber head (mm)	Model No.	Bending radius (mm)	Fiber cable length Free-cut	Sensing range (mm in) (Note 1)		Beam axis dia. (mm)	Beam axis position / Inclination of beam axis	Protection	Ambient temp.	Dimensions	
					FX-500 series	U-LG LONG FAST H-SP						
Threaded	M3	Tough FT-31	R2 Bending durability	2 m	STD 315 12.402 HYPR 210 8.268 1,350 53.150	770 30.315 550 21.654 210 8.268 70 2.756	ø0.5	150 µm / ±2°	IP67	-55 to +80 °C	P.51	
		FT-31W	R1		STD 260 10.236 HYPR 150 5.906 990 38.976	590 23.228 440 17.323 150 5.906 53 2.087						
	M4	Lens mountable	FT-43	R4 Bending durability	2 m	STD 1,400 55.118 HYPR (Note 2) 3,600 141.732	2,800 110.236 2,100 82.677 770 30.315 240 9.449	ø1.5	150 µm / ±2°	IP67	-55 to +80 °C	P.51
			Tough FT-42	R4		STD 1,130 44.488 HYPR (Note 2) 3,600 141.732	2,050 80.709 1,600 62.992 530 20.866 190 7.480					
		Lens mountable	FT-42W	R1	2 m	STD 800 31.496 HYPR (Note 2) 3,300 129.921	1,900 74.803 1,400 55.118 490 19.291 160 6.299	ø1	150 µm / ±3°	IP67	-40 to +60 °C	P.52
			Lens mountable, Stainless-jacketed	FT-45X		R4	1 m					
		Elbow	Tough FT-R40	R4	2 m	STD 930 36.614 HYPR (Note 2) 3,600 141.732	1,750 68.898 1,500 59.055 500 19.685 160 6.299	ø10	—	IP67	-40 to +70 °C	P.51
		Long range	Tough FT-140	R4	10 m	STD (Note 2) 19,600 771.654 HYPR (Note 2) 19,600 771.654	19,600 771.654 (Note 2) 19,600 771.654 (Note 2) 16,000 629.921 6,300 248.031					

Notes: 1) Note that the sensing range of the free-cut type fiber may be reduced by 20 % max. depending upon how the fiber is cut.
2) The fiber cable length practically limits the sensing range.

Tough : Refers to a fiber which possesses both unbreakable (bending radius: R10 mm R0.394 in, reciprocating bending: 180°) and more flexible (bending radius: R4 mm R0.157 in or less) features.

- FIBER SENSORS
- LASER SENSORS
- PHOTO-ELECTRIC SENSORS
- MICRO PHOTO-ELECTRIC SENSORS
- AREA SENSORS
- LIGHT CURTAINS / SAFETY COMPONENTS
- PRESSURE / FLOW SENSORS
- INDUCTIVE PROXIMITY SENSORS
- PARTICULAR USE SENSORS
- SENSOR OPTIONS
- SIMPLE WIRE-SAVING UNITS
- WIRE-SAVING SYSTEMS
- MEASUREMENT SENSORS
- STATIC ELECTRICITY PREVENTION DEVICES
- LASER MARKERS
- PLC
- HUMAN MACHINE INTERFACES
- ENERGY CONSUMPTION VISUALIZATION COMPONENTS
- FA COMPONENTS
- MACHINE VISION SYSTEMS
- UV CURING SYSTEMS
- Selection Guide
- Fibers
- Fiber Amplifiers
- FX-500
- FX-100
- FX-300
- FX-410
- FX-311
- FX-301-F7 / FX-301-F

LIST OF FIBERS

Threaded type

Reflective type 

Type	Shape of fiber head (mm)	Model No.	Bending radius (mm)	Fiber cable length Free-cut	Sensing range (mm in) (Note 1, 2)		Beam axis position / Inclination of beam axis	Protection	Ambient temp.	Dimensions	
					FX-500 series	U-LG LONG FAST H-SP					
Threaded	M3	Tough FD-31	R2 Bending durability	2 m	STD 125 4.921 HYPR 515 20.276	290 11.417 220 8.661 80 3.150 25 0.984	150 μm / ±3°	IP67	-55 to +80 °C	P.59	
		FD-31W	R1		STD 80 3.150 HYPR 330 12.992	180 7.087 140 5.512 45 1.772 12 0.472					
	Ultra-small diameter	Coaxial, Lens mountable FD-32G	R2 Bending durability	1 m (Note 3)	STD 200 7.874 HYPR 650 25.591	380 14.961 270 10.630 95 3.740 27 1.063	—	IP40	-55 to +80 °C		
		Coaxial, Lens mountable, Stainless-jacketed FD-32GX	R2		STD 200 7.874 HYPR 630 24.803	410 16.142 360 14.173 100 3.937 30 1.181					
	M4	Coaxial, Lens mountable FD-EG30	R4	500 mm	STD 48 1.890 HYPR 170 6.693	130 5.118 110 4.331 30 1.181 9 0.354	—	IP40	-40 to +70 °C	P.61	
		Coaxial, Lens mountable FD-EG31			STD 20 0.787 HYPR 85 3.346	45 1.772 35 1.378 12 0.472 3.5 0.138					-20 to +60 °C
	M6	M4	Tough FD-41	R2 Bending durability	2 m	STD 125 4.921 HYPR 515 20.276	290 11.417 220 8.661 80 3.150 25 0.984	150 μm / ±3°	IP67	-55 to +80 °C	
			FD-41W	R1		STD 270 10.630 HYPR 900 35.433	630 24.803 430 16.929 150 5.906 45 1.772				
		M6	Coaxial, Lens mountable FD-42G	R2 Bending durability	2 m	STD 200 7.874 HYPR 650 25.591	380 14.961 270 10.630 95 3.740 27 1.063	—	IP40	-55 to +80 °C	
			Coaxial, Lens mountable FD-42GW	R1		STD 150 5.906 HYPR 670 26.378	340 13.386 280 11.024 90 3.543 25 0.984				
Elbow	M6	Tough FD-62	R4 Bending durability	2 m	STD 520 20.472 HYPR 1,500 59.055	1,000 39.370 940 37.008 340 13.386 110 4.331	150 μm / ±3°	IP67	-55 to +80 °C	P.60	
		Tough FD-61	R1		STD 450 17.717 HYPR 1,400 55.118	840 33.071 670 26.378 200 7.874 70 2.756					
	M6	FD-61W	R1	STD 270 10.630 HYPR 900 35.433	630 24.803 430 16.929 150 5.906 45 1.772	—	IP40	-40 to +60 °C			
		Tough FD-61G	R4 Bending durability	STD 420 16.535 HYPR 1,100 43.307	800 31.496 650 25.591 200 7.874 60 2.362						
		Stainless-jacketed FD-64X	R4	STD 280 11.024 HYPR 670 26.378	500 19.685 410 16.142 160 6.299 50 1.969						
Elbow FD-R60	R4 Bending durability	2 m	STD 290 11.417 HYPR 1,100 43.307	600 23.622 550 21.654 190 7.480 65 2.559	150 μm / ±3°	IP67	-55 to +80 °C	P.66			

Notes: 1) Note that the sensing range of the free-cut type fiber may be reduced by 20 % max. depending upon how the fiber is cut.
 2) The sensing range is specified for white non-glossy paper.
 3) The allowable cutting range is 700 mm 27.559 in from the end that the amplifier inserted.

Tough : Refers to a fiber which possesses both unbreakable (bending radius: R10 mm R0.394 in, reciprocating bending: 180°) and more flexible (bending radius: R4 mm R0.157 in or less) features.

FIBER SENSORS

LASER SENSORS

PHOTO-ELECTRIC SENSORS

MICRO PHOTO-ELECTRIC SENSORS

AREA SENSORS

LIGHT CURTAINS / SAFETY COMPONENTS

PRESSURE / FLOW SENSORS

INDUCTIVE PROXIMITY SENSORS

PARTICULAR USE SENSORS

SENSOR OPTIONS

WIRE-SAVING UNITS

WIRE-SAVING SYSTEMS

MEASUREMENT SENSORS

STATIC ELECTRICITY PREVENTION DEVICES

LASER MARKERS

PLC

HUMAN MACHINE INTERFACES

ENERGY CONSUMPTION VISUALIZATION COMPONENTS

FA COMPONENTS

MACHINE VISION SYSTEMS

UV CURING SYSTEMS

Selection Guide

Fibers

Fiber Amplifiers

FX-500

FX-100

FX-300

FX-410

FX-311

FX-301-F7/
FX-301-F

LIST OF FIBERS

Square head type

Thru-beam type (one pair set)



Type	Shape of fiber head (mm)	Model No.	Bending radius (mm)	Fiber cable length Free-cut	Sensing range (mm in) (Note 1)		Beam axis dia. (Fiber Core) (mm)	Protection	Ambient temp.	Dimensions		
					FX-500 series	U-LG LONG FAST H-SP						
Square head	M3 	Tough FT-R31	R2 Bending durability	2m	STD 270 10.630 HYPR 1,000 39.370	580 22.835 440 17.323 160 6.299 55 2.165	ø0.5	IP67	-55 to +80 °C	P.54		
		Lens mountable FT-R43	R4 Bending durability		STD 720 28.346 HYPR 3,000 118.110	1,600 62.992 1,100 43.307 430 16.929 130 5.118						
	M4 	FT-R41W	R1		STD 800 31.496 HYPR 3,200 125.984	1,800 70.866 1,400 55.118 460 18.110 150 5.906	ø1	IP40	-40 to +60 °C			
		With expansion lens FT-R42W			STD 2,200 86.614 HYPR (Note2) 3,600 141.732	3,600 141.732(Note 2) 3,500 137.795 1,300 51.181 460 18.110						
	M6 	Cable-protection type Compatible with lens FT-R44Y	Tough NEW		R4 Bending durability	STD 720 28.346 HYPR 3,000 118.110	1,600 62.992 1,100 43.307 430 16.929 130 5.118	ø1	IP67 (Note 3)		-55 to +80 °C	P.55
		Full-protection type FT-R60Y	Tough NEW		STD 720 28.346 HYPR (Note2) 3,600 141.732	1,600 62.992 1,100 43.307 430 16.929 130 5.118						

Notes: 1) Note that the sensing range of the free-cut type fiber may be reduced by 20 % max. depending upon how the fiber is cut.
 2) The fiber cable length practically limits the sensing range.
 3) The fiber part is oil-resistant.

Reflective type



Type	Shape of fiber head (mm)	Model No.	Bending radius (mm)	Fiber cable length Free-cut	Sensing range (mm in) (Note 1, 2)		Beam axis dia. (Fiber Core) (mm)	Protection	Ambient temp.	Dimensions
					FX-500 series	U-LG LONG FAST H-SP				
Square head	M3 	Tough FD-R31G	R2 Bending durability	2m	STD 170 6.693 HYPR 530 20.866	310 12.205 260 10.236 85 3.346 27 1.063	Emitter ø0.5	IP40	-55 to +80 °C	P.66
		FD-R32EG	R4		STD 45 1.772 HYPR 170 6.693	110 4.331 92 3.622 30 1.181 9 0.354				
	M3 	FD-R34EG	R4		STD 38 1.496 HYPR 130 5.118	90 3.543 70 2.756 23 0.906 7 0.276	Emitter ø0.175	IP40	-40 to +70 °C	
		FD-R33EG			STD 19 0.748 HYPR 84 3.307	44 1.732 33 1.299 11 0.433 3 0.118				
	M4 	Tough FD-R41	R2 Bending durability		STD 210 8.268 HYPR 710 27.953	430 16.929 320 12.598 100 3.937 34 1.339	Emitter ø0.75	IP67	-55 to +80 °C	
	M6 	Tough NEW FD-R61Y	R4 Bending durability		STD 280 11.024 HYPR 990 38.976	610 24.016 435 17.126 160 6.299 50 1.969				

Notes: 1) Note that the sensing range of the free-cut type fiber may be reduced by 20 % max. depending upon how the fiber is cut.
 2) The sensing range is specified for white non-glossy paper.
 3) The fiber part is oil-resistant.

Tough : Refers to a fiber which possesses both unbreakable (bending radius: R10 mm R0.394 in, reciprocating bending: 180°) and more flexible (bending radius: R4 mm R0.157 in or less) features.

LIST OF FIBERS

Cylindrical type

Thru-beam type (one pair set)



Type	Shape of fiber head (mm)	Model No.	Bending radius (mm)	Fiber cable length Free-cut	Sensing range (mm in) (Note 1)		Beam axis dia. (mm)	Beam axis position / Inclination of beam axis	Protection	Ambient temp.	Dimensions		
					FX-500 series	U-LG FAST LONG H-SP							
Cylindrical		Tough FT-S11	R2	500 mm	STD 90 3.543 HYPR 350 13.780	210 8.268 160 6.299 60 2.362 19 0.748	0.25	—	IP67	-55 to +80 °C	P.55		
		Tough FT-S21	R2		STD 315 12.402 HYPR 1,350 53.150	770 30.315 550 21.654 210 8.268 70 2.756							
		FT-S21W	R1	2 m	STD 260 10.236 HYPR 990 38.976	590 23.228 440 17.323 150 5.906 53 2.087	0.5	150 μm / ±2° 150 μm / ±3°	IP40	-40 to +60 °C			
		Tough FT-S32	R10		STD 3,100 122.047 HYPR (Note 2) 3,600 141.732	3,600 141.732 (Note 2) 3,600 141.732 (Note 2) 1,800 70.866 600 23.622							
		FT-S31W	R1	1 m	STD 800 31.496 HYPR 3,300 129.921	1,900 74.803 1,400 55.118 490 19.291 160 6.299	0.1	150 μm / ±3°	IP67	-40 to +60 °C			
		Tough FT-E13	R2		STD 15 0.591 HYPR 52 2.047	30 1.181 24 0.945 8 0.315 2 0.079							
	Ultra-small diameter		Tough FT-E23	R2	1 m	STD 75 2.953 HYPR 270 10.630	160 6.299 125 4.921 42 1.654 13 0.512	0.125	—	IP50		-40 to +70 °C	
			Tough FT-V40	R4		STD 3,500 137.795 HYPR (Note 2) 3,600 141.732	3,600 141.732 (Note 2) 3,600 141.732 (Note 2) 2,400 94.488 850 33.465						
	Side-view												

Notes: 1) Note that the sensing range of the free-cut type fiber may be reduced by 20 % max. depending upon how the fiber is cut.
2) The fiber cable length practically limits the sensing range.

Reflective type



Type	Shape of fiber head (mm)	Model No.	Bending radius (mm)	Fiber cable length Free-cut	Sensing range (mm in) (Note 1, 2)		Beam axis position / Inclination of beam axis	Protection	Ambient temp.	Dimensions
					FX-500 series	U-LG FAST LONG H-SP				
Cylindrical		Tough FD-S21	R2	1 m	STD 80 3.150 HYPR 190 7.480	130 5.118 110 4.331 37 1.457 11 0.433	—	IP40	-55 to +80 °C	P.66
		Tough FD-S32	R4		STD 420 16.535 HYPR 1,200 47.244	790 31.102 660 25.984 220 8.661 75 2.953				
		FD-S32W	R1	2 m	STD 270 10.630 HYPR 900 35.433	630 24.803 430 16.929 150 5.906 45 1.772	—	IP67	-40 to +60 °C	P.67
		Tough FD-S31	R2		STD 125 4.921 HYPR 515 20.276	290 11.417 220 8.661 80 3.150 25 0.984				
		FD-S33GW	R1	2 m	STD 150 5.906 HYPR 670 26.378	340 13.386 280 11.024 90 3.543 25 0.984	—	IP40	-40 to +60 °C	P.61
		Tough NEW FD-S60Y	R4		STD 320 12.598 HYPR 600 23.622	590 23.228 420 16.535 200 7.874 75 2.953				
	Ultra-small diameter		FD-E13	R4	1 m	STD 12 0.472 HYPR 50 1.969	29 1.142 25 0.984 7 0.276 2 0.079	—	IP40	-40 to +60 °C
			FD-E23	R4		STD 55 2.165 HYPR 170 6.693	120 4.724 80 3.150 30 1.181 9 0.354			

Notes: 1) Note that the sensing range of the free-cut type fiber may be reduced by 20 % max. depending upon how the fiber is cut.
2) The sensing range is specified for white non-glossy paper.
3) The allowable cutting range is 500 mm 19.685 in from the end that is inserted to the amplifier.

Tough : Refers to a fiber which possesses both unbreakable (bending radius: R10 mm R0.394 in, reciprocating bending: 180°) and more flexible (bending radius: R4 mm R0.157 in or less) features.

FIBER SENSORS

LASER SENSORS

PHOTO-ELECTRIC SENSORS

MICRO PHOTO-ELECTRIC SENSORS

AREA SENSORS

LIGHT CURTAINS / SAFETY COMPONENTS

PRESSURE / FLOW SENSORS

INDUCTIVE PROXIMITY SENSORS

PARTICULAR USE SENSORS

SENSOR OPTIONS

SIMPLE WIRE-SAVING UNITS

WIRE-SAVING SYSTEMS

MEASUREMENT SENSORS

STATIC ELECTRICITY PREVENTION DEVICES

LASER MARKERS

PLC

HUMAN MACHINE INTERFACES

ENERGY CONSUMPTION VISUALIZATION COMPONENTS

FA COMPONENTS

MACHINE VISION SYSTEMS

UV CURING SYSTEMS

Selection Guide

Fibers

Fiber Amplifiers

FX-500

FX-100

FX-300

FX-410

FX-311

FX-301-F7/
FX-301-F

LIST OF FIBERS

Sleeve

Thru-beam type (one pair set)

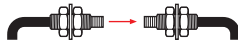

Type	Shape of fiber head (mm)	Model No.	Bending radius (mm)	Fiber cable length Free-cut	Sensing range (mm in) (Note 1, 2)		Beam axis dia. (mm)	Protection	Ambient temp.	Dimensions
					FX-500 series	U-LG LONG FAST H-SP				
Threaded	M3 Sleeve 40mm ø0.88 10	Tough FT-31S	R2 Bending durability (Note 3)	2 m	STD 315 12.402 HYPR 1,220 48.031	740 29.134 550 21.654 195 7.677 63 2.480	ø0.5	IP67	-55 to +80 °C	P.51
	M4 Sleeve 40mm ø1.48 12	Tough FT-42S	R4 Bending durability (Note 3)		STD 1,130 44.488 HYPR 3,600 141.732	2,050 80.709 1,600 62.992 530 20.866 190 7.480	ø1			
Cylindrical	Ultra-small diameter ø3 Narrow beam ø0.125mm Sleeve part cannot be bent. ø0.25 ø3 15 15	Tough FT-E13	R2 Bending durability	1 m	STD 15 0.591 HYPR 52 2.047	30 1.181 24 0.945 8 0.315 2 0.079	ø0.125	IP67	-40 to +70 °C	P.52
		Tough FT-E23	R2 Bending durability		STD 175 6.299 HYPR 270 10.630	160 6.299 125 4.921 42 1.654 13 0.512	ø0.25			
	Side-view ø2 Sleeve part cannot be bent. ø1 ø2 20 15	Tough FT-V23	R4 Bending durability	2 m	STD 450 17.717 HYPR 1,800 70.866	1,000 39.370 880 34.646 280 11.024 90 3.543	ø0.75	IP30	-55 to +80 °C	P.55
		Tough FT-V25	R2 Bending durability		STD 240 9.449 HYPR 900 35.433	550 21.654 480 18.898 140 5.512 45 1.772	ø0.5			
	Side-view ø2.5 Sleeve part cannot be bent. ø1.5 ø2.5 15 15	Tough FT-V24W	R1	2 m	STD 110 4.331 HYPR 380 14.961	230 9.055 200 7.874 60 2.362 20 0.787	ø0.5	IP30	-40 to +60 °C	P.56
		Tough FT-V30	R4 Bending durability		STD 680 26.772 HYPR 2,200 86.614	1,200 47.244 1,000 39.370 340 13.386 100 3.937	ø1.0			

Notes: 1) Note that the sensing range of the free-cut type fiber may be reduced by 20 % max. depending upon how the fiber is cut.
 2) The fiber cable length practically limits the sensing range. 3) Bending radius of sleeve part is R10 mm R0.394 in or more.

Reflective type



Type	Shape of fiber head (mm)	Model No.	Bending radius (mm)	Fiber cable length Free-cut	Sensing range (mm in) (Note 1, 2)		Protection	Ambient temp.	Dimensions
					FX-500 series	U-LG LONG FAST H-SP			
Threaded	Ultra-small diameter M3 Sleeve 15 mm ø0.8 15 Sleeve part cannot be bent.	Tough FD-EG30S	R4	1 m	STD 50 1.969 HYPR 170 6.693	110 4.331 80 3.150 30 1.181 9 0.354	IP40	-40 to +70 °C	P.62
	M4 Sleeve 40 mm ø1.48 12	Tough FD-41S	R2 Bending durability (Note 3)		STD 125 4.921 HYPR 515 20.276	290 11.417 220 8.661 80 3.150 25 0.984	IP67	-55 to +80 °C	P.59
		Tough FD-41SW	R1 (Note 3)		STD 80 3.150 HYPR 330 12.992	180 7.087 140 5.512 45 1.772 12 0.472			
M6 Sleeve 40 mm ø2.5 15	Tough FD-61S	R4 Bending durability (Note 3)	STD 420 16.535 HYPR 1,200 47.244	790 31.102 660 25.984 220 8.661 75 2.953	IP67	-55 to +80 °C	P.60		
Cylindrical	Ultra-small diameter ø1.5 Sleeve part cannot be bent. ø1.5 ø0.48 15 15	Tough FD-E13	R4	1 m	STD 12 0.472 HYPR 50 1.969	29 1.142 25 0.984 7 0.276 2 0.079	IP40	-40 to +60 °C	P.61
		Tough FD-E23			STD 55 2.165 HYPR 170 6.693	120 4.724 80 3.150 30 1.181 9 0.354			
	Side-view ø3 Sleeve part cannot be bent. Small diameter ø3 ø0.63 ø3 ø1.5 15 15	Tough FD-V30	R2 Bending durability	2 m	STD 65 2.559 HYPR 240 9.449	130 5.118 120 4.724 35 1.378 14 0.551	IP30	-55 to +80 °C	P.67
		Tough FD-V30W	R1		STD 20 0.787 HYPR 80 3.150	40 1.575 30 1.181 10 0.394 2 0.079			
	Side-view ø5 Sleeve part cannot be bent. ø5 ø2 15 20	Tough FD-V50	R4 Bending durability	STD 120 4.724 HYPR 370 14.567	220 8.661 210 8.268 75 2.953 25 0.984	IP30	-55 to +80 °C	P.68	

Notes: 1) Note that the sensing range of the free-cut type fiber may be reduced by 20 % max. depending upon how the fiber is cut.
 2) The sensing range is specified for white non-glossy paper. 3) Bending radius of sleeve part is R10 mm R0.394 in or more.

Tough : Refers to a fiber which possesses both unbreakable (bending radius: R10 mm R0.394 in, reciprocating bending: 180°) and more flexible (bending radius: R4 mm R0.157 in or less) features.

- FIBER SENSORS
- LASER SENSORS
- PHOTO-ELECTRIC SENSORS
- MICRO PHOTO-ELECTRIC SENSORS
- AREA SENSORS
- LIGHT CURTAINS/ SAFETY COMPONENTS
- PRESSURE / FLOW SENSORS
- INDUCTIVE PROXIMITY SENSORS
- PARTICULAR USE SENSORS
- SENSOR OPTIONS
- SIMPLE WIRE-SAVING UNITS
- WIRE-SAVING SYSTEMS
- MEASURE-MENT SENSORS
- STATIC ELECTRICITY PREVENTION DEVICES
- LASER MARKERS
- PLC
- HUMAN MACHINE INTERFACES
- ENERGY CONSUMPTION VISUALIZATION COMPONENTS
- FA COMPONENTS
- MACHINE VISION SYSTEMS
- UV CURING SYSTEMS
- Selection Guide
- Fibers
- Fiber Amplifiers

- FX-500
- FX-100
- FX-300
- FX-410
- FX-311
- FX-301-F7/ FX-301-F

LIST OF FIBERS

Flat type

Thru-beam type (one pair set)

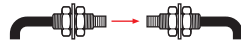

Type	Shape of fiber head (mm)	Model No.	Bending radius (mm)	Fiber cable length ☒ : Free-cut	Sensing range (mm in) (Note 1)		Beam axis dia. (mm)	Protection	Ambient temp.	Dimensions
					FX-500 series	U-LG LONG FAST H-SP				
Flat	Top sensing W3 × H8 × D12	Tough FT-Z30H	R2 Bending durability	☒	STD 3,500 137.795	3,600 141.732 (Note 2)	2 × 3	IP40	-40 to +60 °C	P.57
	Top sensing W3 × H8 × D12	FT-Z30HW	R1		HYPR (Note 2) 3,600 141.732	3,600 141.732 (Note 2) 2,600 102.362 810 31.890				
	Side sensing W3 × H12 × D8	Tough FT-Z30E	R2 Bending durability		STD 3,500 137.795	3,600 141.732 (Note 2)				
	Side sensing W3 × H12 × D8	FT-Z30EW	R1		HYPR (Note 2) 3,600 141.732	3,600 141.732 (Note 2) 2,400 94.488 740 29.134				
	Front sensing W8.5 × H12 × D3	Tough FT-Z30	R2 Bending durability		STD 2,100 82.677	3,600 141.732 (Note 2)				
	Front sensing W8.5 × H12 × D3	FT-Z30W			HYPR (Note 2) 3,600 141.732	3,600 141.732 (Note 2) 2,000 78.740 630 24.803				
	Front sensing W10 × H7 × D2	FT-Z20W	R1		STD 620 24.409	1,500 59.055 1,100 43.307 420 16.535 130 5.118				
	Fiber bending type W2 × H10 × D10	FT-Z20HBW			HYPR (Note 2) 1,600 62.992	670 26.378 570 22.441 180 7.087 55 2.165				
	Front sensing W14 × H7 × D3.5	FT-Z40W	☒		STD 1,500 59.055	3,300 129.921				
	Fiber bending type W3.5 × H14 × D11	FT-Z40HBW			HYPR (Note 2) 3,600 141.732	2,300 90.551 900 35.433 290 11.417				
			STD 800 31.496	1,900 74.803 1,400 55.118 490 19.291 160 6.299						

Notes: 1) Note that the sensing range of the free-cut type fiber may be reduced by 20 % max. depending upon how the fiber is cut.
2) The fiber cable length practically limits the sensing range.

Reflective type



Type	Shape of fiber head (mm)	Model No.	Bending radius (mm)	Fiber cable length ☒ : Free-cut	Sensing range (mm in) (Note 1, 2)		Protection	Ambient temp.	Dimensions
					FX-500 series	U-LG LONG FAST H-SP			
Flat	Front sensing W10 × H7 × D2	FD-Z20W	R1	☒	STD 1 to 65 0.039 to 2.559	150 5.906 130 5.118	IP40	-40 to +60 °C	P.68
	Fiber bending type W2 × H10 × D10	FD-Z20HBW			HYPR 260 10.236	2 to 45 0.079 to 1.772 5 to 13 0.197 to 0.512			
	Front sensing W14 × H7 × D3.5	FD-Z40W			STD 190 7.480	440 17.323 390 15.354			
	Fiber bending type W3.5 × H14 × D11	FD-Z40HBW			HYPR 790 31.102	1 to 120 0.039 to 4.724 2 to 35 0.079 to 1.378			
				☒	STD 260 10.236	540 21.260 470 18.504	IP67		
				HYPR 760 29.921	1 to 160 0.039 to 6.299 2 to 50 0.079 to 1.969				

Notes: 1) Note that the sensing range of the free-cut type fiber may be reduced by 20 % max. depending upon how the fiber is cut.
2) The sensing range is specified for white non-glossy paper.

Tough : Refers to a fiber which possesses both unbreakable (bending radius: R10 mm R0.394 in, reciprocating bending: 180°) and more flexible (bending radius: R4 mm R0.157 in or less) features.

FIBER SENSORS

LASER SENSORS

PHOTO-ELECTRIC SENSORS

MICRO PHOTO-ELECTRIC SENSORS

AREA SENSORS

LIGHT CURTAINS / SAFETY COMPONENTS

PRESSURE / FLOW SENSORS

INDUCTIVE PROXIMITY SENSORS

PARTICULAR USE SENSORS

SENSOR OPTIONS

WIRE-SAVING UNITS

WIRE-SAVING SYSTEMS

MEASUREMENT SENSORS

STATIC ELECTRICITY PREVENTION DEVICES

LASER MARKERS

PLC

HUMAN MACHINE INTERFACES

ENERGY CONSUMPTION VISUALIZATION COMPONENTS

FA COMPONENTS

MACHINE VISION SYSTEMS

UV CURING SYSTEMS

Selection Guide

Fibers

Fiber Amplifiers

FX-500

FX-100

FX-300

FX-410







FX-311

FX-301-F7/
FX-301-F

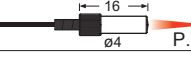
LIST OF FIBERS

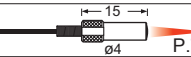
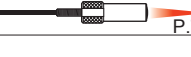
Small spot

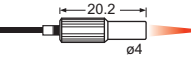
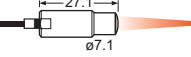
High precision fiber & spot lens

Designation	Shape of head (mm) Dimensions	Spot diameter (mm in) (Note)	Distance to focal point (mm in) (Note)	Lens		Applicable fibers									
				Model No.	Ambient temp.	Model No.	Fiber cable length ✂: Free-cut	Bending radius (mm)	Protection	Ambient temp.	Dimensions				
Finest spot lens	 P.71	ø0.1 ø0.004	7 ±0.5 0.276 ±0.020	FX-MR6	-20 to +60 °C	FD-EG31	500 mm	R4	IP40	-20 to +60 °C	P.62				
	 P.71	ø0.2 ø0.008				FD-EG30				-40 to +70 °C	P.61				
	 P.71	ø0.15 ø0.006				7.5 ±0.5 0.295 ±0.020	FX-MR3	-40 to +70 °C		Tough FD-42G	2 m	R2 Bending durability	-55 to +80 °C	P.60	
										FD-42GW		R1	-40 to +60 °C		
										Tough FD-32G	1 m	R2 Bending durability	-55 to +80 °C		P.59
										FD-32GX		R2	-55 to +80 °C		
	 P.71	ø0.3 ø0.012				7.5 ±0.5 0.295 ±0.020	FX-MR3	-40 to +70 °C		FD-EG31	500 mm	R4	-20 to +60 °C	P.62	
										FD-EG30			-40 to +70 °C	P.61	
	 P.71	ø0.5 ø0.020				7.5 ±0.5 0.295 ±0.020	FX-MR3	-40 to +70 °C		Tough FD-42G	2 m	R2 Bending durability	-55 to +80 °C	P.60	
										FD-42GW		R1	-40 to +60 °C		
 P.71	ø0.5 ø0.020	7.5 ±0.5 0.295 ±0.020	FX-MR3	-40 to +70 °C	Tough FD-32G	1 m	R2 Bending durability	-55 to +80 °C	P.59						
					FD-32GX		R2	-55 to +80 °C							
Pinpoint spot lens	 P.70	ø0.5 ø0.020	6 ±1 0.236 ±0.039	FX-MR1	-40 to +70 °C	Tough FD-42G	2 m	R2 Bending durability	-55 to +80 °C	P.60					
						FD-42GW		R1	-40 to +60 °C						
Zoom lens	 P.70	ø0.7 to ø2.0 ø0.028 to ø0.079	18.5 to 43 approx. 0.728 to 1.693 approx.	FX-MR2	-40 to +70 °C	Tough FD-42G	2 m	R2 Bending durability	-55 to +80 °C	P.60					
						FD-42GW		R1	-40 to +60 °C						
Zoom lens (Side-view type)	 P.71	ø0.5 to ø3.0 ø0.020 to ø0.118	13 to 30 approx. 0.512 to 1.181 approx.	FX-MR5	-40 to +70 °C	Tough FD-42G	2 m	R2 Bending durability	-55 to +80 °C	P.60					
						FD-42GW		R1	-40 to +60 °C						

Note: Spot diameter, distance to focal point and sensing range are specified for FX-500 series.

Tough : Refers to a fiber which possesses both unbreakable (bending radius: R10 mm R0.394 in, reciprocating bending: 180°) and more flexible (bending radius: R4 mm R0.157 in or less) features.

LIST OF FIBERS

Small spot

Square head type M3, reflective type fiber & spot lens

Type	Spot diameter (mm in) (Note)	Distance to focal point (mm in) (Note)	Lens		Fiber		
			Shape (mm in) Dimensions	Model No.	Shape	Emitting fiber core (mm in)	Model No.
Finest spot lens	ø0.1 ø0.004 approx.	7 ±0.5 0.276 ±0.020		FX-MR7		ø0.125 ø0.005	FD-R33EG
	ø0.15 ø0.006 approx.					ø0.125 ø0.005	FD-EG31
	ø0.2 ø0.008 approx.					ø0.175 ø0.007	FD-R34EG
	ø0.4 ø0.016 approx.					ø0.25 ø0.010	FD-R32EG
		ø0.25 ø0.010	FD-EG30				
		ø0.5 ø0.020	FD-R31G				
		ø0.5 ø0.020	FD-32G				
		ø0.5 ø0.020	FD-32GX				
		ø0.5 ø0.020	FD-42G				
						ø0.5 ø0.020	FD-42GW
				P.71			
Type	Spot diameter (mm in) (Note)	Sensing range (mm in) (Note)	Lens	Model No.	Applicable fibers		
			Shape (mm in)		Emitting fiber core (mm in)	Model No.	
Zoom lens	ø0.4 to ø2.0 ø0.016 to ø0.079 approx.	10 to 30 0.394 to 1.181		FX-MR8	ø0.125 ø0.005	FD-R33EG, FD-EG31	
	ø0.4 to ø2.2 ø0.016 to ø0.087 approx.				ø0.175 ø0.007	FD-R34EG	
	ø0.5 to ø2.5 ø0.020 to ø0.098 approx.				ø0.25 ø0.010	FD-R32EG, FD-EG30	
	ø0.8 to ø3.5 ø0.031 to ø0.138 approx.				ø0.5 ø0.020	FD-R31G, FD-32G, FD-32GX, FD-42G, FD-42GW	
				P.71			
Parallel light lens	ø4.0 ø0.157 approx.	0 to 30 0 to 1.181		FX-MR9	ø0.125 ø0.005	FD-R33EG, FD-EG31	
					ø0.175 ø0.007	FD-R34EG	
					ø0.25 ø0.010	FD-R32EG, FD-EG30	
					ø0.5 ø0.020	FD-R31G, FD-32G, FD-32GX, FD-42G, FD-42GW	
				P.71			

Note: Spot diameter, distance to focal point and sensing range are specified for FX-500 series.

FIBER SENSORS

LASER SENSORS

PHOTO-ELECTRIC SENSORS

MICRO PHOTO-ELECTRIC SENSORS

AREA SENSORS

LIGHT CURTAINS / SAFETY COMPONENTS

PRESSURE / FLOW SENSORS

INDUCTIVE PROXIMITY SENSORS

PARTICULAR USE SENSORS

SENSOR OPTIONS

WIRE-SAVING UNITS

WIRE-SAVING SYSTEMS

MEASUREMENT SENSORS

STATIC ELECTRICITY PREVENTION DEVICES

LASER MARKERS

PLC

HUMAN MACHINE INTERFACES

ENERGY CONSUMPTION VISUALIZATION COMPONENTS

FA COMPONENTS

MACHINE VISION SYSTEMS

UV CURING SYSTEMS

Selection Guide

Fibers

Fiber Amplifiers

FX-500

FX-100

FX-300

FX-410

FX-311

FX-301-F7/
FX-301-F

LIST OF FIBERS

Narrow beam

Thru-beam type (one pair set)



Type	Shape of fiber head (mm)	Model No.	Bending radius (mm)	Fiber cable length Free-cut	Sensing range (mm in) (Note 1)		Beam axis dia. (mm)	Inclination of beam axis	Protection	Ambient temp.	Dimensions
					FX-500 series	U-LG LONG FAST H-SP					
Narrow beam Side-view		Tough FT-KS40	R2	2 m	STD 3,600 141.732	3,600 141.732 (Note 2)	ø2.2	—	IP40	-40 to +60 °C	P.54
		Tough FT-KV40	R1		STD 3,600 141.732	3,600 141.732 (Note 2)	ø2.5	±0.8°	IP30		
		Tough FT-KV40W	R1		STD 3,600 141.732	3,600 141.732 (Note 2)	ø2.5	±0.8°	IP30		
		Tough FT-KV26	R2		STD 710 27.953	1,600 62.992	ø1	X ±1° Z ±0.5°	IP30		

Notes: 1) Note that the sensing range of the free-cut type fiber may be reduced by 20 % max. depending upon how the fiber is cut.
2) The fiber cable length practically limits the sensing range.

Retroreflective type

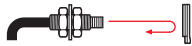

Type	Shape of fiber head (mm)	Model No.	Bending radius (mm)	Fiber cable length Free-cut	Sensing range (mm in) (Note 1, 2)		Protection	Ambient temp.	Dimensions
					FX-500 series	U-LG LONG FAST H-SP			
With polarizing filter		FR-Z50HW	R1	2 m	STD 100 to 990 3.937 to 38.976	100 to 1,400 3.937 to 55.118	IP40	-25 to +55 °C	P.58
			HYPR 100 to 1,900 3.937 to 74.803		100 to 1,200 3.937 to 47.244 100 to 780 3.937 to 30.709 100 to 490 3.937 to 19.291				
Wafer mapping		Tough FR-KZ22E	R2		STD 15 to 310 0.591 to 12.205	15 to 460 0.591 to 18.110 15 to 410 0.591 to 16.142 15 to 220 0.591 to 8.661 15 to 100 0.591 to 3.937	IP30	-40 to +60 °C	
			HYPR 15 to 570 0.591 to 22.441						
Narrow beam Top sensing		Tough FR-KZ50H	R2		STD 20 to 300 0.787 to 11.811	20 to 800 0.787 to 31.496 20 to 400 0.787 to 15.748 20 to 200 0.787 to 7.874 20 to 200 0.787 to 7.874	IP30	-40 to +60 °C	
	Side sensing				Tough FR-KZ50E	HYPR 20 to 1,000 0.787 to 39.370			

Notes: 1) Note that the sensing range of the free-cut type fiber may be reduced by 20 % max. depending upon how the fiber is cut.
2) The sensing range is the possible setting range for the attached reflector. The fiber can detect an object less than setting range for the reflector. Refer to p.90 for the sensing range when **FR-Z50HW** is used in combination with a reflector (optional).

Reflective type



Type	Shape of fiber head (mm)	Model No.	Bending radius (mm)	Fiber cable length Free-cut	Sensing range (mm in) (Note 1, 2)		Protection	Ambient temp.	Dimensions
					FX-500 series	U-LG LONG FAST H-SP			
Long range		FD-Z50HW	R1	2 m	STD 10 to 650 0.394 to 25.591	10 to 1,100 0.394 to 43.307 10 to 1,000 0.394 to 39.370 10 to 410 0.394 to 16.142 15 to 130 0.591 to 5.118	IP40	-40 to +60 °C	P.68
					HYPR 10 to 2,500 0.394 to 98.425				

Notes: 1) Note that the sensing range of the free-cut type fiber may be reduced by 20 % max. depending upon how the fiber is cut.
2) The sensing range is specified for white non-glossy paper.

Tough : Refers to a fiber which possesses both unbreakable (bending radius: R10 mm R0.394 in, reciprocating bending: 180°) and more flexible (bending radius: R4 mm R0.157 in or less) features.

LIST OF FIBERS

Wide beam

Thru-beam type (one pair set)



Type	Shape of fiber head (mm)	Model No.	Bending radius (mm)	Fiber cable length ✂️ : Free-cut	Sensing range (mm in) (Note 1)		Beam axis dia. (mm)	Protection	Ambient temp.	Dimensions
					FX-500 series	U-LG LONG FAST H-SP				
Wide beam		Tough FT-A32	R2 Bending durability	✂️ 2 m	STD (Note 2) 3,600 141.732 HYPR (Note 2) 3,600 141.732	3,600 141.732 (Note 2) 3,600 141.732 (Note 2) 2,100 82.677	3.2 x 32	IP40	-40 to +60 °C	P.52
	Allows flexible wiring 	FT-A32W	R1		STD (Note 2) 3,600 141.732 HYPR (Note 2) 3,600 141.732	3,600 141.732 (Note 2) 3,600 141.732 (Note 2) 3,000 118.110				
		Tough FT-A11	R2 Bending durability		STD (Note 2) 3,600 141.732 HYPR (Note 2) 3,600 141.732	3,600 141.732 (Note 2) 3,600 141.732 (Note 2) 1,100 43.307	-40 to +70 °C			
	Allows flexible wiring 	FT-A11W	R1		STD (Note 2) 3,600 141.732 HYPR (Note 2) 3,600 141.732	3,600 141.732 (Note 2) 3,600 141.732 (Note 2) 1,300 51.181			-40 to +55 °C	
Array		Tough FT-AL05	R2 Bending durability	STD 860 33.858 HYPR 2,300 90.551	1,550 61.024 1,500 59.055 500 19.685 170 6.693	0.25 x 5.5		-55 to +80 °C		

Notes: 1) Note that the sensing range of the free-cut type fiber may be reduced by 20 % max. depending upon how the fiber is cut.
2) The fiber cable length practically limits the sensing range.

Reflective type



Type	Shape of fiber head (mm)	Model No.	Bending radius (mm)	Fiber cable length ✂️ : Free-cut	Sensing range (mm in) (Note 1, 2)		Protection	Ambient temp.	Dimensions
					FX-500 series	U-LG LONG FAST H-SP			
Wide beam		Tough FD-A16	R4 Bending durability	✂️ 2 m	STD 200 7.874 HYPR Cannot use	200 7.874 200 7.874 140 5.512 75 2.953	IP40	-40 to +60 °C	P.61
Array		Tough FD-AL11	R2 Bending durability		STD 320 12.598 HYPR 670 26.378	530 20.866 510 20.079 180 7.087 50 1.969			

Notes: 1) Note that the sensing range of the free-cut type fiber may be reduced by 20 % max. depending upon how the fiber is cut.
2) The sensing range is specified for white non-glossy paper.

Tough : Refers to a fiber which possesses both unbreakable (bending radius: R10 mm R0.394 in, reciprocating bending: 180°) and more flexible (bending radius: R4 mm R0.157 in or less) features.

FIBER SENSORS

LASER SENSORS

PHOTO-ELECTRIC SENSORS

MICRO PHOTO-ELECTRIC SENSORS

AREA SENSORS

LIGHT CURTAINS / SAFETY COMPONENTS

PRESSURE / FLOW SENSORS

INDUCTIVE PROXIMITY SENSORS

PARTICULAR USE SENSORS

SENSOR OPTIONS

SIMPLE WIRE-SAVING UNITS

WIRE-SAVING SYSTEMS

MEASUREMENT SENSORS

STATIC ELECTRICITY PREVENTION DEVICES

LASER MARKERS

PLC

HUMAN MACHINE INTERFACES

ENERGY CONSUMPTION VISUALIZATION COMPONENTS

FA COMPONENTS

MACHINE VISION SYSTEMS

UV CURING SYSTEMS

Selection Guide

Fibers

Fiber Amplifiers

FX-500

FX-100

FX-300

FX-410

FX-311

FX-301-F7/
FX-301-F

LIST OF FIBERS

Convergent reflective type

Reflective type



Type	Shape of fiber head (mm)	Model No.	Bending radius (mm)	Fiber cable length Free-cut	Sensing range (mm in) (Note 1, 2)		Protection	Ambient temp.	Dimensions	
					FX-500 series	U-LG LONG FAST H-SP				
Glass substrate detection	 W25 × H7.3 × D30	FD-L32H	R4 Bending durability	4 m	STD 0 to 56 0 to 2.205 HYPR 0 to 110 0 to 4.331	0 to 87 0 to 3.425 0 to 74 0 to 2.913 1 to 38 0.039 to 1.496 Cannot use	IP40	-40 to +60 °C	P.66	
	 W20 × H29 × D3.8	Tough FD-L30A	R2 Bending durability	3 m	STD 0 to 43 0 to 1.693 HYPR 0 to 43 0 to 1.693	0 to 43 0 to 1.693 0 to 43 0 to 1.693 0 to 42 0 to 1.654 0 to 29 0 to 1.142				0 to +70 °C
	 W23.5 × H29 × D4.5	Tough FD-L31A	R4 Bending durability		STD 4 to 33 0.157 to 1.299 HYPR 3 to 35 0.118 to 1.378	4 to 33 0.157 to 1.299 4 to 33 0.157 to 1.299 4 to 32 0.157 to 1.260 5 to 25 0.197 to 0.984				
	 W17 × H29 × D3.8	Tough FD-L22A	R2 Bending durability	2 m	STD 0 to 24 0 to 0.945 HYPR 0 to 31 0 to 1.220	0 to 28 0 to 1.102 0 to 27 0 to 1.063 0 to 24 0 to 0.945 0 to 18 0 to 0.709				-20 to +70 °C
	 W18 × H29 × D3.8	Tough FD-L23	Bending durability	3 m	STD 0 to 29 0 to 1.142 HYPR 0 to 30 0 to 1.181	0 to 30 0 to 1.181 0 to 30 0 to 1.181 0 to 28 0 to 1.102 1.5 to 24 0.059 to 0.945				
	 W12 × H19 × D3	Tough FD-L11	R4 Bending durability	2 m	STD 0 to 9.5 0 to 0.374 HYPR 0 to 11.5 0 to 0.453	0 to 10.5 0 to 0.413 0 to 10 0 to 0.394 0 to 9 0 to 0.354 0 to 8 0 to 0.315				-40 to +60 °C
	 W12 × H19 × D3	Tough FD-L10	Bending durability		STD 0 to 5 0 to 0.197 HYPR 0 to 6 0 to 0.236	0 to 5.5 0 to 0.217 0 to 5.5 0 to 0.217 0 to 4.5 0 to 0.177 0 to 4 0 to 0.157				
	 W24 × H21 × D4	Tough FD-L21	R2 Bending durability		STD 1.5 to 16 0.059 to 0.630 HYPR 1 to 19 0.039 to 0.748	1 to 18 0.039 to 0.709 1 to 18 0.039 to 0.709 2 to 15 0.079 to 0.591 3 to 12 0.118 to 0.472				
	 W24 × H21 × D4	FD-L21W	R1 Bending durability	1 m	STD 3 to 14 0.118 to 0.551 HYPR 1.5 to 15 0.059 to 0.591	2 to 15 0.079 to 0.591 2 to 15 0.079 to 0.591 4 to 14 0.157 to 0.551 6.5 to 10 0.256 to 0.394				-40 to +70 °C
	 W6 × H18 × D14	Tough FD-L20H	R2 Bending durability		STD 23 0.906 HYPR 45 1.772	35 1.378 32 1.260 2 to 15 0.079 to 0.591 5 to 9 0.197 to 0.354				
Ultra-small	 W7.2 × H7.5 × D2	FD-L12W	R1 Bending durability	STD 8 0.315 HYPR 14 0.551	12.5 0.492 12 0.472 0.5 to 7 0.020 to 0.276 0.5 to 4 0.020 to 0.157	IP30	-40 to +60 °C			

Notes: 1) Note that the sensing range of the free-cut type fiber may be reduced by 20 % max. depending upon how the fiber is cut.
 2) The sensing range is specified for transparent glass 100 × 100 × t0.7 mm 3.937 × 3.937 × t0.028 in (FD-L32H: R edge, FD-L21 and FD-L21W: t2 mm 0.079 in) (FD-L20H: white non-glossy paper, FD-L10: silicon wafers 100 × 100 mm 3.937 × 3.937 in).

Selection Guide
Fibers
Fiber Amplifiers

FX-500
FX-100
FX-300
FX-410
FX-311
FX-301-F7/
FX-301-F

Tough : Refers to a fiber which possesses both unbreakable (bending radius: R10 mm R0.394 in, reciprocating bending: 180°) and more flexible (bending radius: R4 mm R0.157 in or less) features.

LIST OF FIBERS

Retroreflective type

Retroreflective type 

Type	Shape of fiber head (mm)	Model No.	Bending radius (mm)	Fiber cable length ✂️ : Free-cut	Sensing range (mm in) (Note 1, 2)		Protection	Ambient temp.	Dimensions
					FX-500 series	U-LG LONG FAST H-SP			
With polarizing filters	W5.2 × H9.5 × D16 W30 × H30 × D0.5	FR-Z50HW	R1	✂️ 2 m	STD 100 to 990 3.937 to 38.976 HYPR 100 to 1,900 3.937 to 74.803	100 to 1,400 3.937 to 55.118 100 to 1,200 3.937 to 47.244 100 to 780 3.937 to 30.709 100 to 490 3.937 to 19.291	IP40	-25 to +55 °C	P.58
Water mapping	W7.5 × H2.2 × D11.2 Aperture angle 3° (emitter) W4 × H2 × D21.5	Tough FR-KZ22E	R2 Bending durability		STD 15 to 310 0.591 to 12.205 HYPR 15 to 570 0.591 to 22.441	15 to 460 0.591 to 18.110 15 to 410 0.591 to 16.142 15 to 220 0.591 to 8.661 15 to 100 0.591 to 3.937	IP30	-40 to +60 °C	
Narrow beam Top sensing	W5.2 × H9.5 × D21 W10.6 × H28 × D10.1	Tough FR-KZ50H			STD 20 to 300 0.787 to 11.811 HYPR 20 to 1,000 0.787 to 39.370	20 to 800 0.787 to 31.496 20 to 400 0.787 to 15.748 20 to 200 0.787 to 7.874 20 to 200 0.787 to 7.874			
	Side sensing	W9.5 × H25 × D5.2 W28 × H10.6 × D10.1	Tough FR-KZ50E						

- Notes: 1) Note that the sensing range of the free-cut type fiber may be reduced by 20 % max. depending upon how the fiber is cut. The sensing range of **FR-KZ22E** is specified for the attached reflector. The sensing range of **FR-KZ50E** and **FR-KZ50H** is specified for the attached reflector **RF-003**. The sensing range of **FR-Z50HW** is specified for the **RF-13**.
- 2) The sensing range is the possible setting range for the attached reflector. The fiber can detect an object less than setting range for the reflector. However, note that if there are any white or highly-reflective surfaces near the fiber head, reflected incident light may affect the fiber head. If this occurs, adjust the threshold value of the amplifier unit before use.

Sensing range when FR-Z50HW is used in combination with a reflector (optional)

Reflector model No.	Sensing range (mm in)						
	FX-500 series						
	HYPR	U-LG	LONG	STD	FAST	H-SP	
RF-230	100 to 19,000 3.937 to 748.030	100 to 8,000 3.937 to 314.960	100 to 5,000 3.937 to 196.850	100 to 3,600 3.937 to 141.732	100 to 2,900 3.937 to 114.173	100 to 1,400 3.937 to 55.118	
RF-220	100 to 8,000 3.937 to 314.960	100 to 4,700 3.937 to 185.039	100 to 3,500 3.937 to 137.795	100 to 3,000 3.937 to 118.110	100 to 1,800 3.937 to 70.866	100 to 830 3.937 to 32.677	
RF-210	100 to 5,500 3.937 to 216.535	100 to 2,700 3.937 to 106.299	100 to 2,400 3.937 to 94.488	100 to 1,500 3.937 to 59.055	100 to 1,200 3.937 to 47.244	100 to 530 3.937 to 20.866	

Note: The sensing range is the possible setting range for the reflector. The fiber can detect an object less than 100 mm **3.937 in**. However, note that if there are any white or highly-reflective surfaces near the fiber head, reflected incident light may affect the fiber head. If this occurs, adjust the threshold value of the amplifier unit before use.

Tough : Refers to a fiber which possesses both unbreakable (bending radius: R10 mm **R0.394 in**, reciprocating bending: 180°) and more flexible (bending radius: R4 mm **R0.157 in** or less) features.

FIBER SENSORS

LASER SENSORS

PHOTO-ELECTRIC SENSORS

MICRO PHOTO-ELECTRIC SENSORS

AREA SENSORS

LIGHT CURTAINS / SAFETY COMPONENTS

PRESSURE / FLOW SENSORS

INDUCTIVE PROXIMITY SENSORS

PARTICULAR USE SENSORS

SENSOR OPTIONS

SIMPLE WIRE-SAVING UNITS

WIRE-SAVING SYSTEMS

MEASUREMENT SENSORS

STATIC ELECTRICITY PREVENTION DEVICES

LASER MARKERS

PLC

HUMAN MACHINE INTERFACES

ENERGY CONSUMPTION VISUALIZATION COMPONENTS

FA COMPONENTS

MACHINE VISION SYSTEMS

UV CURING SYSTEMS

Selection Guide

Fibers

Fiber Amplifiers

FX-500

FX-100

FX-300

FX-410

FX-311

FX-301-F7/
FX-301-F

LIST OF FIBERS

Chemical / oil-resistant

Thru-beam type (one pair set)

Type	Shape of fiber head (mm)	Model No.	Bending radius (mm)	Fiber cable length ☒ : Free-cut	Sensing range (mm in) (Note 1)		Beam axis dia. (mm)	Protection	Ambient temp.	Dimensions
					FX-500 series	U-LG LONG FAST H-SP				
Oil-resistant Square head type	M4 Cable-protection type Compatible with lens W7 × H9.5 × D15.5	Tough NEW FT-R44Y	R4 Bending durability	☒ 2 m	STD 720 28.346 HYPR 3,000 118.110	1,600 62.992 1,100 43.307 430 16.929 130 5.118	ø1	IP67 (Note 4)	-55 to +80 °C	P.55
	M6 Full-protection type W10 × H11 × D21.2	Tough NEW FT-R60Y	R4 Bending durability	☒ 2 m	STD 2,100 82.677 HYPR (Note2) 3,600 141.732	3,600 141.732 (Note 2) 3,600 141.732 (Note 2) 1,260 49.606 400 15.748	ø3.5		-55 to +80 °C	
Chemical-resistant Cylindrical type	Flat type Easy mounting • Rectangular head SEMI S2 compliant W7 × H15 × D13 Metal-free	Tough FT-Z802Y	R4 Bending durability	☒ 2 m	STD 3,100 122.047 HYPR (Note2) 3,600 141.732	3,600 141.732 (Note 2) 3,600 141.732 (Note 2) 1,900 74.803 470 18.504	ø3.7	IP68G	0 to +60 °C	P.57
	Heat-resistant 115 °C Metal-free	FT-HL80Y	R30 Bending durability	☒ 2 m (Note 3)	STD (Note2) 3,600 141.732 HYPR (Note2) 3,600 141.732	3,600 141.732 (Note 2) 3,600 141.732 (Note 2) 2,300 90.551 740 29.134			-40 to +115 °C	P.53
	Metal-free	FT-L80Y			STD (Note2) 3,600 141.732 HYPR (Note2) 3,600 141.732	3,600 141.732 (Note 2) 3,600 141.732 (Note 2) 2,800 110.236 920 36.220			-40 to +70 °C	P.54
	Side-view Metal-free	FT-V80Y			STD 1,300 51.181 HYPR (Note2) 3,600 141.732	2,800 110.236 2,200 86.614 800 31.496 240 9.449				P.56

- Notes: 1) Note that the sensing range of the free-cut type fiber may be reduced by 20 % max. depending upon how the fiber is cut.
 2) The fiber cable length practically limits the sensing range.
 3) The allowable cutting range is 500 mm 19.685 in from the end that the amplifier inserted.
 4) The fiber part is oil-resistant.

Reflective type



Type	Shape of fiber head (mm)	Model No.	Bending radius (mm)	Fiber cable length ☒ : Free-cut	Sensing range (mm in) (Note 1, 2)		Beam axis dia. (mm)	Protection	Ambient temp.	Dimensions
					FX-500 series	U-LG LONG FAST H-SP				
Oil-resistant Square head type	M6 Cable-protection type W10 × H11 × D15.5	Tough NEW FD-R61Y	R4 Bending durability	☒ 2 m	STD 280 11.024 HYPR 990 38.976	610 24.016 435 17.126 160 6.299 50 1.969	—	IP67 (Note 3)	-55 to +80 °C	P.66
Chemical-resistant Cylindrical type	Metal-free ø5.5 -(16)-	Tough NEW FD-S60Y	R4 Bending durability	☒ 2 m (Note 4)	STD 320 12.598 HYPR 600 23.622	590 23.228 420 16.535 200 7.874 75 2.953	—	IP68G	-40 to +70 °C	P.67

- Notes: 1) Note that the sensing range of the free-cut type fiber may be reduced by 20 % max. depending on how the fiber is cut.
 2) The sensing range is specified for white, non-glossy paper.
 3) The fiber part is oil-resistant.
 4) The allowable cutting range is 500 mm 19.685 in from the end that is inserted to the amplifier.

- FX-500
- FX-100
- FX-300
- FX-410
- FX-311
- FX-301-F7/
FX-301-F

Tough : Refers to a fiber which possesses both unbreakable (bending radius: R10 mm R0.394 in, reciprocating bending: 180°) and more flexible (bending radius: R4 mm R0.157 in or less) features.

LIST OF FIBERS

Heat-resistant

Thru-beam type (one pair set)



Type	Heat-resistant temp.	Shape of fiber head (mm)	Model No.	Bending radius (mm)	Fiber cable length ✂️: Free-cut	Sensing range (mm in) (Note 1)		Beam axis dia. (mm)	Ambient temp.	Dimensions		
						FX-500 series	U-LG LONG FAST H-SP					
Heat-resistant	350 °C	Lens mountable (FX-LE1/LE2/SV1) 	FT-H35-M2	R25	2 m	STD 430 16.929	880 34.646 670 26.378 250 9.843 80 3.150	ø1.2	-60 to +350 °C	P.53		
		Sleeve 60 mm 	FT-H35-M2S6	Fiber R25 Sleeve R10		HYPR 1,200 47.244						
	200 °C	Allows flexible wiring Lens mountable (FX-LE1/LE2/SV1) 	FT-H20W-M1	R10	1 m	STD 470 18.504 HYPR (Note 2) 1,600 62.992	1,000 39.370 840 33.071 300 11.811 90 3.543	ø0.8	-60 to +200 °C			
		Lens mountable (FX-LE1/LE2/SV1) 	FT-H20-M1	R25		STD 540 21.260 HYPR (Note 2) 1,600 62.992					1,300 51.181 960 37.795 330 12.992 110 4.331	ø1.2
130 °C	Lens mountable (FX-LE2 only) 	FT-H13-FM2	R25	✂️ 2 m	STD 700 27.559 HYPR 1,300 129.921	1,900 74.803 1,300 51.181 410 16.142 140 5.512	ø1.5	-60 to +130 °C	P.52			
Heat-resistant (joint)	200 °C	Lens mountable (FX-LE1/LE2/SV1) 	FT-H20-J20-S (Note 5)	Heat-resistant side R18 (Note 4)	✂️ 200 mm (Note 3)	STD 470 18.504 HYPR 1,600 62.992	1,000 39.370 790 31.102 300 11.811 90 3.543	ø1.2	-60 to +200 °C	P.53		
			FT-H20-J30-S (Note 5)		✂️ 300 mm (Note 3)							
			FT-H20-J50-S (Note 5)		✂️ 500 mm (Note 3)							
		Side-view 	FT-H20-VJ50-S (Note 5)		✂️ 800 mm (Note 3)						STD 600 23.622 HYPR 2,100 82.677	1,300 51.181 980 38.583 390 15.354 120 4.724
			FT-H20-VJ80-S (Note 5)									

- Notes: 1) Note that the sensing range of the free-cut type fiber may be reduced by 20 % max. depending upon how the fiber is cut.
 2) The fiber cable length practically limits the sensing range.
 3) Fiber length (fixed-length) for heat-resistant fiber side. Fiber length for ordinary temperature side is 2 m 6.562 ft (free-cut).
 4) Bending durable fiber R4 mm R0.157 in or more for ordinary temperature side.
 5) Heat-resistant joint fibers and ordinary-temperature fibers (FT-42) are sold as a set.

Heat-resistant joint fiber set contents

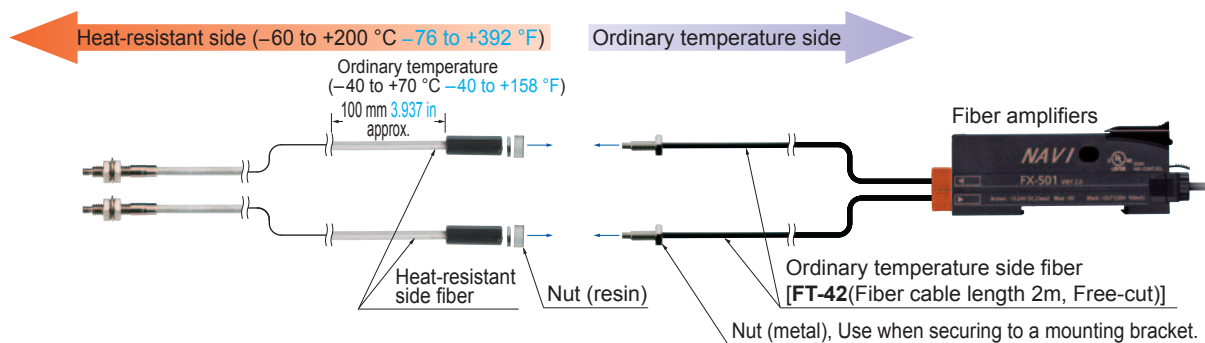

Model No. when ordering individually as spare parts

- Heat-resistant side fiber **one pair set**
FT-H20-J20, FT-H20-J30, FT-H20-J50, FT-H20-VJ50, FT-H20-VJ80
- Ordinary temperature side fiber **one pair set**
FT-42

FIBER SENSORS

LASER SENSORS

PHOTO-ELECTRIC SENSORS

MICRO PHOTO-ELECTRIC SENSORS

AREA SENSORS

LIGHT CURTAINS / SAFETY COMPONENTS

PRESSURE / FLOW SENSORS

INDUCTIVE PROXIMITY SENSORS

PARTICULAR USE SENSORS

SENSOR OPTIONS

WIRE-SAVING UNITS

WIRE-SAVING SYSTEMS

MEASUREMENT SENSORS

STATIC ELECTRICITY PREVENTION DEVICES

LASER MARKERS

PLC

HUMAN MACHINE INTERFACES

ENERGY CONSUMPTION VISUALIZATION COMPONENTS

FA COMPONENTS

MACHINE VISION SYSTEMS

UV CURING SYSTEMS

FX-500

FX-100

FX-300

FX-410

FX-311

FX-301-F7/
FX-301-F

Selection Guide

Fibers

Fiber Amplifiers

LIST OF FIBERS

Heat-resistant

Reflective type



Type	Heat-resistant temp.	Shape of fiber head (mm)	Model No.	Bending radius (mm)	Fiber cable length ✂️: Free-cut	Sensing range (mm in) (Note 1, 2)		Ambient temp.	Dimensions		
						FX-500 series	U-LG LONG FAST H-SP				
Heat-resistant	350 °C	Coaxial M6 25	FD-H35-M2	R25	2 m	STD 260 10.236 HYPR 720 28.346	540 21.260 460 18.110 150 5.906 45 1.772	-60 to +350 °C	P.64		
		Sleeve 60 mm M6 22 ø2.8	FD-H35-M2S6	Fiber R25 Sleeve R10							
		Sleeve 90 mm M4 27 ø2.1	FD-H35-20S			STD 260 10.236 HYPR 840 33.071	550 21.654 440 17.323 140 5.512 45 1.772				
		Coaxial M6 28	FD-H20-M1	R25	1 m	STD 330 12.992 HYPR 840 33.071	550 21.654 500 19.685 200 7.874 55 2.165			-60 to +200 °C	P.63
		Coaxial M4 27	FD-H20-21			STD 230 9.055 HYPR 770 30.315	500 19.685 380 14.961 130 5.118 45 1.772				
		130 °C	M6 21	FD-H13-FM2		✂️ 2 m	STD 350 13.780 HYPR 880 34.646			640 25.197 600 23.622 200 7.874 65 2.559	-60 to +130 °C
	Glass substrate detection convergent reflective	300 °C	W19 × H27 × D5	FD-H30-L32	R25	2 m	STD 17 0.669 HYPR 40 1.575	30 1.181 25 0.984 12 0.472 1.5 to 6 0.059 to 0.236	-60 to +300 °C	P.64	
		250 °C	W21 × H33.2 × D5	FD-H25-L43	R25	3 m	STD 1.5 to 26 0.059 to 1.024 HYPR 1 to 31 0.039 to 1.220	1 to 30 0.039 to 1.181 1 to 28 0.039 to 1.102 1.5 to 24 0.059 to 0.945 2 to 18 0.079 to 0.709	-20 to +250 °C (Ordinary temp. side: -20 to +70 °C)	P.63	
			W21 × H34.5 × D5	FD-H25-L45			STD 5 to 42 0.197 to 1.654 HYPR 4 to 43.5 0.157 to 1.713	4 to 43 0.157 to 1.693 4.5 to 43 0.177 to 1.693 5 to 40 0.197 to 1.575 6.5 to 34 0.256 to 1.339			
		180 °C	W19 × H27 × D5	FD-H18-L31		✂️ 2 m	STD 16 0.630 HYPR 60 2.362	32 1.260 24 0.945 13 0.512 2 to 6.5 0.079 to 0.256	-60 to +180 °C		

Notes: 1) Note that the sensing range of the free-cut type fiber may be reduced by 20 % max. depending upon how the fiber is cut.
 2) The sensing range of reflective type is the value for white non-glossy paper (50 × 50 mm 1.969 × 1.969 in glass substrate for **FD-H30-L32** and **FD-H18-L31**, transparent glass 100 × 100 × t0.7 mm 3.937 × 3.937 × t0.028 in for **FD-H25-L43** and **FD-H25-L45**).

LIST OF FIBERS

Vacuum-resistant

Thru-beam type (one pair set)



Type	Shape of fiber head (mm)	Model No.	Bending radius (mm)	Fiber cable length	Sensing range (mm in)		Beam axis dia. (mm)	Ambient temp.	Dimensions
					FX-500 series	U-LG LONG FAST H-SP			
Vacuum-resistant Thru-beam	300 °C Lens mountable (FV-LE1/SV2) M4 	FT-H30-M1V-S (Note)	R18	1 m	STD 270 10.630 HYPR 1,000 39.370	590 23.228 470 18.504 160 6.299 55 2.165	ø1.2	-30 to +300 °C	P.53

Note: Sold as a set comprising vacuum type fiber + photo-terminal (FV-BR1) + fiber at atmospheric side (FT-J8).

Reflective type



Type	Shape of fiber head (mm)	Model No.	Bending radius (mm)	Fiber cable length	Sensing range (mm in)(Note 2)		Ambient temp.	Dimensions
					FX-500 series	U-LG LONG FAST H-SP		
Vacuum-resistant	300 °C, Rectangular head 	FD-H30-KZ1V-S (Note 1)	R18	1 m	STD 20 to 200 0.787 to 7.874 HYPR 5 to 500 0.197 to 19.685	10 to 340 0.394 to 13.386 15 to 270 0.591 to 10.630 20 to 120 0.787 to 4.724 20 to 45 0.787 to 1.772	-30 to +300 °C	P.64
	300 °C, Glass substrate detection 	FD-H30-L32V-S (Note 1)		3 m	STD 8 0.315 HYPR 18 0.709	12 0.472 10 0.394 5.5 0.217 1.5 to 3 0.059 to 0.118		

Notes: 1) Sold as a set comprising vacuum type fiber + photo-terminal (FV-BR1) + fiber at atmospheric side (FT-J8).

2) The sensing range of reflective type is the value for transparent glass 100 × 100 × t0.7 mm 3.937 × 3.937 × t0.28 in.

Vacuum-resistant fiber set contents

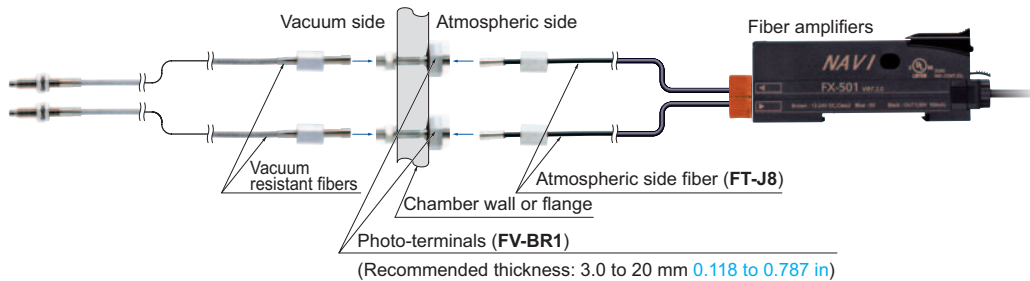

Model No. when ordering individually as spare parts

- Vacuum resistant fiber
FT-H30-M1V (one pair set)
FD-H30-KZ1V
FD-H30-L32V
- Photo-terminal
FV-BR1 (one pair set)
- Atmospheric side fiber
FT-J8 (one pair set)
- Mounting bracket for **FD-H30-KZ1V(-S)**
MS-FD-2

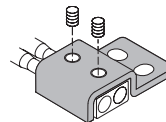

FIBER SENSORS

LASER SENSORS

PHOTO-ELECTRIC SENSORS

MICRO PHOTO-ELECTRIC SENSORS

AREA SENSORS

LIGHT CURTAINS / SAFETY COMPONENTS

PRESSURE / FLOW SENSORS

INDUCTIVE PROXIMITY SENSORS

PARTICULAR USE SENSORS

SENSOR OPTIONS

SMILE WIRE-SAVING UNITS

WIRE-SAVING SYSTEMS

MEASUREMENT SENSORS

STATIC ELECTRICITY PREVENTION DEVICES

LASER MARKERS

PLC

HUMAN MACHINE INTERFACES

ENERGY CONSUMPTION VISUALIZATION COMPONENTS

FA COMPONENTS

MACHINE VISION SYSTEMS

UV CURING SYSTEMS

Selection Guide

Fibers

Fiber Amplifiers

FX-500

FX-100

FX-300

FX-410

FX-311



FX-301-F7/

FX-301-F

LIST OF FIBERS

Liquid leak / Liquid detection

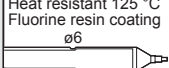
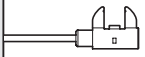
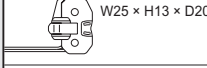
Reflective type / Thru-beam type

Type	Shape of fiber head (mm)	Model No.	Bending radius (mm)	Fiber cable length ✂: Free-cut	Description FX-500 series (STD mode)	Protection	Ambient temp.	Dimensions
Contact type	Liquid level sensing 	Heat resistant 125 °C Fluorine resin coating ø6 FD-F8Y	Protective tube R40 Fiber R15	✂ 2 m (Note 1)	ø6 mm ø0.236 in Protective tube: Fluorine resin, length 1,000 mm 39.370 in (not cuttable) Liquid surface not contacted: Beam received, Liquid surface contacted: Beam not received	IP68	-40 to +125 °C	P.62
		Heat resistant 105 °C Fluorine resin coating Metal-free ø4 FD-HF40Y (Note 2)	Protective tube R20 Fiber R10	✂ 2 m	ø4 mm ø0.157 in Protective tube: Fluorine resin, length 500 mm 19.685 in (cuttable) Liquid surface not contacted: Beam received, Liquid surface contacted: Beam not received	IP68G	-40 to +105 °C	P.64
		Heat resistant 70 °C Fluorine resin coating throughout the fiber Metal-free ø4 FD-F41Y (Note 2)			ø4 mm ø0.157 in Protective tube: Fluorine resin, length 500 mm 19.685 in (cuttable) Liquid surface not contacted: Beam received, Liquid surface contacted: Beam not received			
Liquid leak detection 	SEMI S2 compliant W20 × H30 × D10 Tough FD-F71	R4 Bending durability	✂ 5 m	Liquid leak detection Leak absent: Beam received, Leak present: Beam interrupted Compatible amplifier: FX500 series only	IP67	-20 to +60 °C		
Pipe-mountable type	Liquid level sensing 	Standard W25 × H13 × D20 FD-F41	R10	✂ 2 m	Applicable pipe diameter: Outer dia. ø6 to ø26 mm ø0.236 to ø1.024 in transparent pipe [PVC (vinyl chloride), fluorine resin, polycarbonate, acrylic, glass, wall thickness 1 to 3 mm 0.039 to 0.118 in] Liquid absent: Beam received, Liquid present: Beam not received	—	-40 to +100 °C	P.62
		For 1 mm thick PFA pipe W25 × H13 × D20 FD-F4			Applicable pipe diameter: Outer dia. ø6 to ø26 mm ø0.236 to ø1.024 in transparent pipe [PFA (fluorine resin) or equivalently transparent pipe, wall thickness 1 mm 0.039 in] Liquid absent: Beam received, Liquid present: Beam not received			
	Liquid sensing 	Mountable on pipe-array fiber W6.5 × H28.3 × D17 Tough FD-FA93	R4 Bending durability	✂ 2 m	Applicable pipe diameter: Outer dia. ø8 mm ø0.315 in or more transparent pipe (When used with the tying bands: ø8 to ø80 mm ø0.315 to ø3.150 in) [PFA (fluorine resin), including translucent] Liquid absent: Beam received, Liquid present: Beam not received	IP40	-40 to +70 °C	P.52
		SEMI S2 compliant W23 × H20 × D17 Tough FT-F93	Protective tube R20 Fiber R2 Bending durability		Applicable pipe diameter: Outer dia. ø3 to ø10 mm ø0.118 to ø0.394 in transparent pipe [PFA (fluorine resin) or equivalently transparent pipe, wall thickness 0.3 to 1 mm 0.012 to 0.039 in] Liquid absent: Beam not received, Liquid present: Beam received Compatible amplifier: FX500 series only			

Notes: 1) The allowable cutting range is 1,000 mm **39.370 in** from the end that the amplifier inserted.
2) Liquid inflow prevention joint, protective tube extension joint, fiber mounting joint is available.

Designation	Model No.	Description	
Liquid inflow prevention joint (Note)	MS-FX-01Y	Applicable fibers FD-HF40Y FD-F41Y	This joint suppresses false operations due to liquid slip-in from the top of the protective tube.
Protective tube extension joint (Note)	MS-FX-02Y		The protective tube can be extended.
Fiber mounting joint (Note)	MS-FX-03Y		The joint is used for mounting fibers on a tank.

Note: The joint internal ferrule (**MS-FX-YF**) is available as a spare part. A distorted ferrule may result in leakage.

Liquid inflow prevention joint

Protective tube extension joint

Fiber mounting joint

• **MS-FX-01Y**

• **MS-FX-02Y**

• **MS-FX-03Y**

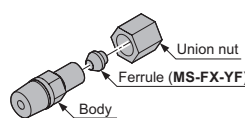
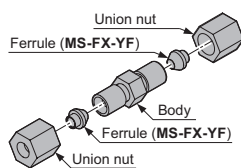
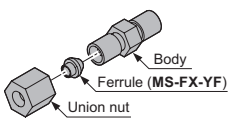

Accessories for additional supply

• **MS-FD-F7-1**

(SUS mounting bracket for **FD-F71**)

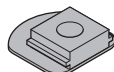

• **MS-FD-F7-2**

(PVC mounting bracket for **FD-F71**)

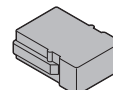

Tough : Refers to a fiber which possesses both unbreakable (bending radius: R10 mm **R0.394 in**, reciprocating bending: 180°) and more flexible (bending radius: R4 mm **R0.157 in** or less) features.

LIST OF FIBERS

Model No. when ordering accessories additionally

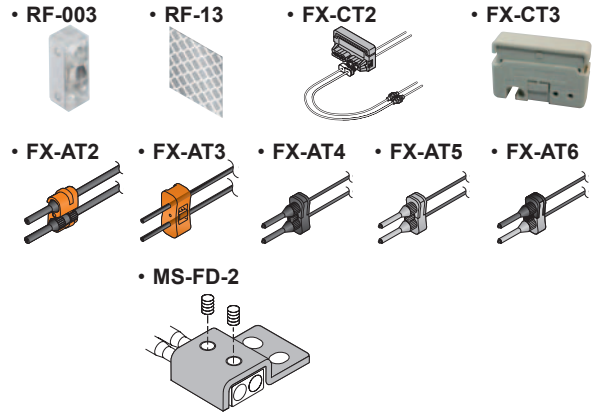

- **RF-003** (Reflector for **FR-KZ50E/KZ50H**)
- **RF-13** (Reflective tape for **FR-Z50HW**)
- **FX-CT2** (Fiber cutter)
- **FX-CT3** (Fiber cutter for **FD-H40Y/F41Y**)
- **FX-AT2** (Attachment for fixed-length fiber, Orange)
- **FX-AT3** (Attachment for $\varnothing 2.2$ mm $\varnothing 0.087$ in fiber, Clear orange)
- **FX-AT4** (Attachment for $\varnothing 1$ mm $\varnothing 0.039$ in fiber, Black)
- **FX-AT5** (Attachment for $\varnothing 1.3$ mm $\varnothing 0.051$ in fiber, Gray)
- **FX-AT6** (Attachment for $\varnothing 1$ mm $\varnothing 0.039$ in / $\varnothing 1.3$ mm $\varnothing 0.051$ in)
(mixed fiber, Black / Gray)
- **MS-FD-2** (Fiber mounting bracket)



FIBER OPTIONS

Refer to p.69~ for details of lens dimensions.

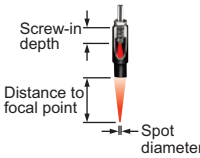
Lens (For reflective type fiber)

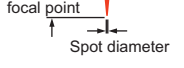
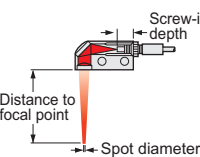
Designation	Model No.	Description												
For reflective type fiber	Pinpoint spot lens FX-MR1	 <p>Pinpoint spot of $\varnothing 0.5$ mm $\varnothing 0.020$ in. Enables detection of minute objects or small marks.</p> <ul style="list-style-type: none"> • Distance to focal point: 6 ± 1 mm 0.236 ± 0.039 in • Applicable fibers: FD-42G, FD-42GW • Ambient temperature: -40 to $+70$ °C -40 to $+158$ °F (Note) 												
	Zoom lens FX-MR2	 <p>The spot diameter is adjustable from $\varnothing 0.7$ to $\varnothing 2$ mm $\varnothing 0.028$ to $\varnothing 0.079$ in according to how much the fiber is screwed in.</p> <ul style="list-style-type: none"> • Applicable fibers: FD-42G, FD-42GW • Ambient temperature: -40 to $+70$ °C -40 to $+158$ °F (Note) • Accessory: MS-EX3 (mounting bracket) <table border="1"> <caption>Sensing range for FX-500 series</caption> <thead> <tr> <th>Screw-in depth</th> <th>Distance to focal point</th> <th>Spot diameter</th> </tr> </thead> <tbody> <tr> <td>7 mm</td> <td>18.5 mm approx.</td> <td>$\varnothing 0.7$ mm</td> </tr> <tr> <td>12 mm</td> <td>27 mm approx.</td> <td>$\varnothing 1.2$ mm</td> </tr> <tr> <td>14 mm</td> <td>43 mm approx.</td> <td>$\varnothing 2.0$ mm</td> </tr> </tbody> </table>	Screw-in depth	Distance to focal point	Spot diameter	7 mm	18.5 mm approx.	$\varnothing 0.7$ mm	12 mm	27 mm approx.	$\varnothing 1.2$ mm	14 mm	43 mm approx.	$\varnothing 2.0$ mm
	Screw-in depth	Distance to focal point	Spot diameter											
	7 mm	18.5 mm approx.	$\varnothing 0.7$ mm											
	12 mm	27 mm approx.	$\varnothing 1.2$ mm											
14 mm	43 mm approx.	$\varnothing 2.0$ mm												
Finest spot lens FX-MR3	 <p>Extremely fine spot of $\varnothing 0.15$ mm $\varnothing 0.006$ in approx. achieved.</p> <ul style="list-style-type: none"> • Applicable fibers: FD-EG31, FD-EG30, FD-42G, FD-42GW, FD-32G, FD-32GX • Ambient temperature: -40 to $+70$ °C -40 to $+158$ °F (Note) <table border="1"> <caption>Sensing range for FX-500 series</caption> <thead> <tr> <th>Fiber model No.</th> <th>Distance to focal point</th> <th>Spot diameter</th> </tr> </thead> <tbody> <tr> <td>FD-EG31</td> <td>7.5 ± 0.5 mm</td> <td>$\varnothing 0.15$ mm approx.</td> </tr> <tr> <td>FD-EG30</td> <td>7.5 ± 0.5 mm</td> <td>$\varnothing 0.3$ mm approx.</td> </tr> <tr> <td>FD-42G/42GW FD-32G/32GX</td> <td>7.5 ± 0.5 mm</td> <td>$\varnothing 0.5$ mm approx.</td> </tr> </tbody> </table>	Fiber model No.	Distance to focal point	Spot diameter	FD-EG31	7.5 ± 0.5 mm	$\varnothing 0.15$ mm approx.	FD-EG30	7.5 ± 0.5 mm	$\varnothing 0.3$ mm approx.	FD-42G/42GW FD-32G/32GX	7.5 ± 0.5 mm	$\varnothing 0.5$ mm approx.	
Fiber model No.	Distance to focal point	Spot diameter												
FD-EG31	7.5 ± 0.5 mm	$\varnothing 0.15$ mm approx.												
FD-EG30	7.5 ± 0.5 mm	$\varnothing 0.3$ mm approx.												
FD-42G/42GW FD-32G/32GX	7.5 ± 0.5 mm	$\varnothing 0.5$ mm approx.												
Finest spot lens FX-MR6	 <p>Extremely fine spot of $\varnothing 0.1$ mm $\varnothing 0.004$ in approx. achieved.</p> <ul style="list-style-type: none"> • Applicable fibers: FD-EG31, FD-EG30, FD-42G, FD-42GW, FD-32G, FD-32GX • Ambient temperature: -20 to $+60$ °C -4 to $+140$ °F (Note) <table border="1"> <caption>Sensing range for FX-500 series</caption> <thead> <tr> <th>Fiber model No.</th> <th>Distance to focal point</th> <th>Spot diameter</th> </tr> </thead> <tbody> <tr> <td>FD-EG31</td> <td>7 ± 0.5 mm</td> <td>$\varnothing 0.1$ mm approx.</td> </tr> <tr> <td>FD-EG30</td> <td>7 ± 0.5 mm</td> <td>$\varnothing 0.2$ mm approx.</td> </tr> <tr> <td>FD-42G/42GW FD-32G/32GX</td> <td>7 ± 0.5 mm</td> <td>$\varnothing 0.4$ mm approx.</td> </tr> </tbody> </table>	Fiber model No.	Distance to focal point	Spot diameter	FD-EG31	7 ± 0.5 mm	$\varnothing 0.1$ mm approx.	FD-EG30	7 ± 0.5 mm	$\varnothing 0.2$ mm approx.	FD-42G/42GW FD-32G/32GX	7 ± 0.5 mm	$\varnothing 0.4$ mm approx.	
Fiber model No.	Distance to focal point	Spot diameter												
FD-EG31	7 ± 0.5 mm	$\varnothing 0.1$ mm approx.												
FD-EG30	7 ± 0.5 mm	$\varnothing 0.2$ mm approx.												
FD-42G/42GW FD-32G/32GX	7 ± 0.5 mm	$\varnothing 0.4$ mm approx.												
Zoom lens (side-view type) FX-MR5	 <p>FX-MR2 is converted into a side-view type and can be mounted in a very small space.</p> <ul style="list-style-type: none"> • Applicable fibers: FD-42G, FD-42GW • Ambient temperature: -40 to $+70$ °C -40 to $+158$ °F (Note) <table border="1"> <caption>Sensing range for FX-500 series</caption> <thead> <tr> <th>Screw-in depth</th> <th>Distance to focal point</th> <th>Spot diameter</th> </tr> </thead> <tbody> <tr> <td>8 mm</td> <td>13 mm approx.</td> <td>$\varnothing 0.5$ mm</td> </tr> <tr> <td>10 mm</td> <td>15 mm approx.</td> <td>$\varnothing 0.8$ mm</td> </tr> <tr> <td>14 mm</td> <td>30 mm approx.</td> <td>$\varnothing 3.0$ mm</td> </tr> </tbody> </table>	Screw-in depth	Distance to focal point	Spot diameter	8 mm	13 mm approx.	$\varnothing 0.5$ mm	10 mm	15 mm approx.	$\varnothing 0.8$ mm	14 mm	30 mm approx.	$\varnothing 3.0$ mm	
Screw-in depth	Distance to focal point	Spot diameter												
8 mm	13 mm approx.	$\varnothing 0.5$ mm												
10 mm	15 mm approx.	$\varnothing 0.8$ mm												
14 mm	30 mm approx.	$\varnothing 3.0$ mm												

Note: Refer to p.80 or p.85 for the ambient temperature of fibers to be used in combination.

FIBER SENSORS

LASER SENSORS

PHOTO-ELECTRIC SENSORS

MICRO PHOTO-ELECTRIC SENSORS

AREA SENSORS

LIGHT CURTAINS / SAFETY COMPONENTS

PRESSURE / FLOW SENSORS

INDUCTIVE PROXIMITY SENSORS

PARTICULAR USE SENSORS

SENSOR OPTIONS

SIMPLE WIRE-SAVING UNITS

WIRE-SAVING SYSTEMS

MEASUREMENT SENSORS

STATIC ELECTRICITY PREVENTION DEVICES

LASER MARKERS

PLC

HUMAN MACHINE INTERFACES

ENERGY CONSUMPTION VISUALIZATION COMPONENTS

FA COMPONENTS

MACHINE VISION SYSTEMS

UV CURING SYSTEMS

Selection Guide

Fibers

Fiber Amplifiers

FX-500

FX-100

FX-300

FX-410

FX-311

FX-301-F7/
FX-301-F

FIBER OPTIONS

Refer to p.69~ for details of lens dimensions.

Lens (For square head M3 reflective fiber)

Type		Spot diameter (mm in)(Note)	Distance to focal point (mm in)(Note)	Lens		Fiber		
				Shape (mm in)	Model No.	Shape	Emitting fiber core (mm in)	Model No.
For Square head M3 reflective fiber	Finest spot lens	ø0.1 ø0.004 approx.	7 ± 0.5 0.276 ± 0.020	ø5 ø0.197	FX-MR7		ø0.125 ø0.005	FD-R33EG
		ø0.15 ø0.006 approx.					ø0.125 ø0.005	FD-EG31
		ø0.2 ø0.008 approx.					ø0.175 ø0.007	FD-R34EG
		ø0.4 ø0.016 approx.					ø0.25 ø0.010	FD-R32EG
							ø0.25 ø0.010	FD-EG30
							ø0.5 ø0.020	FD-R31G
							ø0.5 ø0.020	FD-32G
							ø0.5 ø0.020	FD-32GX
							ø0.5 ø0.020	FD-42G
							ø0.5 ø0.020	FD-42GW

Type		Spot diameter (mm in)(Note)	Sensing range (mm in)(Note)	Lens		Applicable fibers	
				Shape (mm in)	Model No.	Emitting fiber core (mm in)	Model No.
For Square head M3 reflective fiber	Zoom lens	ø0.4 to ø2.0 ø0.016 to ø0.079 approx.	10 to 30 0.394 to 1.181	ø5 ø0.197	FX-MR8	ø0.125 ø0.005	FD-R33EG, FD-EG31
		ø0.4 to ø2.2 ø0.016 to ø0.087 approx.				ø0.175 ø0.007	FD-R34EG
		ø0.5 to ø2.5 ø0.020 to ø0.098 approx.				ø0.25 ø0.010	FD-R32EG, FD-EG30
		ø0.8 to ø3.5 ø0.031 to ø0.138 approx.				ø0.5 ø0.020	FD-R31G, FD-32G, FD-32GX, FD-42G, FD-42GW
PLC	Parallel light lens	ø4.0 ø0.157 approx.	0 to 30 0 to 1.181	ø5 ø0.197	FX-MR9	ø0.125 ø0.005	FD-R33EG, FD-EG31
						ø0.175 ø0.007	FD-R34EG
						ø0.25 ø0.010	FD-R32EG, FD-EG30
						ø0.5 ø0.020	FD-R31G, FD-32G, FD-32GX, FD-42G, FD-42GW

Note: Spot diameter, distance to focal point and sensing range are specified for FX-500 series.





- FIBER SENSORS
- LASER SENSORS
- PHOTO-ELECTRIC SENSORS
- MICRO PHOTO-ELECTRIC SENSORS
- AREA SENSORS
- LIGHT CURTAINS / SAFETY COMPONENTS
- PRESSURE / FLOW SENSORS
- INDUCTIVE PROXIMITY SENSORS
- PARTICULAR USE SENSORS
- SENSOR OPTIONS
- SIMPLE WIRE-SAVING UNITS
- WIRE-SAVING SYSTEMS
- MEASUREMENT SENSORS
- STATIC ELECTRICITY PREVENTION DEVICES
- LASER MARKERS
- PLC
- HUMAN MACHINE INTERFACES
- ENERGY CONSUMPTION VISUALIZATION COMPONENTS
- FA COMPONENTS
- MACHINE VISION SYSTEMS
- UV CURING SYSTEMS

- Selection Guide
- Fibers
- Fiber Amplifiers
- FX-500**
- FX-100**
- FX-300**
- FX-410**
- FX-311**
- FX-301-F7/
FX-301-F

FIBER OPTIONS

Refer to p.69~ for details of lens dimensions.

Lens (For thru-beam type fiber)

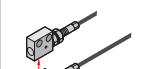
Designation	Model No.	Description										
Expansion lens (Note 1)	FX-LE1		Increases the sensing range by 5 times or more. • Ambient temperature: -60 to +350 °C -76 to +662 °F (Note 4) • Beam dia: ø3.6 mm ø0.142 in	Sensing range (mm in) [Lens on both sides]								
				Fiber	Mode	HYPR	U-LG	LONG	STD	FAST	H-SP	
				FT-43		3,600 141.732 (Note 2)	3,600 141.732 (Note 2)	3,600 141.732 (Note 2)	3,600 141.732 (Note 2)	3,600 141.732 (Note 2)	3,600 141.732 (Note 2)	1,600 62.992
				FT-42		3,600 141.732 (Note 2)	3,600 141.732 (Note 2)	3,600 141.732 (Note 2)	3,600 141.732 (Note 2)	3,600 141.732 (Note 2)	3,600 141.732 (Note 2)	2,200 86.614
				FT-42W		3,600 141.732 (Note 2)	3,600 141.732 (Note 2)	3,600 141.732 (Note 2)	3,600 141.732 (Note 2)	3,600 141.732 (Note 2)	3,600 141.732 (Note 2)	2,200 86.614
				FT-45X		1,600 62.992 (Note 2)	1,600 62.992 (Note 2)	1,600 62.992 (Note 2)	1,600 62.992 (Note 2)	1,600 62.992 (Note 2)	1,600 62.992 (Note 2)	1,500 59.055
				FT-R40		3,600 141.732 (Note 2)	3,600 141.732 (Note 2)	3,600 141.732 (Note 2)	3,600 141.732 (Note 2)	3,600 141.732 (Note 2)	3,600 141.732 (Note 2)	1,900 74.803
				FT-R43		3,600 141.732 (Note 2)	3,600 141.732 (Note 2)	3,600 141.732 (Note 2)	3,600 141.732 (Note 2)	3,600 141.732 (Note 2)	3,600 141.732 (Note 2)	1,900 74.803
				FT-H35-M2		3,600 141.732 (Note 2)	3,600 141.732 (Note 2)	3,600 141.732 (Note 2)	3,600 141.732 (Note 2)	3,600 141.732 (Note 2)	3,600 141.732 (Note 2)	3,300 129.921
				FT-H20W-M1		1,600 62.992 (Note 2)	1,600 62.992 (Note 2)	1,600 62.992 (Note 2)	1,600 62.992 (Note 2)	1,600 62.992 (Note 2)	1,600 62.992 (Note 2)	850 33.465
FT-H20-M1		1,600 62.992 (Note 2)	1,600 62.992 (Note 2)	1,600 62.992 (Note 2)	1,600 62.992 (Note 2)	1,600 62.992 (Note 2)	1,600 62.992 (Note 2)	1,200 47.244				
FT-H20-J50-S		3,600 141.732 (Note 2)	3,600 141.732 (Note 2)	3,500 137.795	2,000 78.740	1,600 62.992	500 19.685					
FT-H20-J30-S												
FT-H20-J20-S												
Super-expansion lens (Note 1)	FX-LE2		Tremendously increases the sensing range with large diameter lenses. • Ambient temperature: -60 to +350 °C -76 to +662 °F (Note 4) • Beam dia: ø9.8 mm ø0.386 in	Sensing range (mm in) [Lens on both sides]								
				Fiber	Mode	HYPR	U-LG	LONG	STD	FAST	H-SP	
				FT-43		3,600 141.732 (Note 2)	3,600 141.732 (Note 2)	3,600 141.732 (Note 2)	3,600 141.732 (Note 2)	3,600 141.732 (Note 2)	3,600 141.732 (Note 2)	3,600 141.732 (Note 2)
				FT-42		3,600 141.732 (Note 2)	3,600 141.732 (Note 2)	3,600 141.732 (Note 2)	3,600 141.732 (Note 2)	3,600 141.732 (Note 2)	3,600 141.732 (Note 2)	3,600 141.732 (Note 2)
				FT-42W		3,600 141.732 (Note 2)	3,600 141.732 (Note 2)	3,600 141.732 (Note 2)	3,600 141.732 (Note 2)	3,600 141.732 (Note 2)	3,600 141.732 (Note 2)	3,600 141.732 (Note 2)
				FT-45X		1,600 62.992 (Note 2)	1,600 62.992 (Note 2)	1,600 62.992 (Note 2)	1,600 62.992 (Note 2)	1,600 62.992 (Note 2)	1,600 62.992 (Note 2)	1,600 62.992 (Note 2)
				FT-R40		3,600 141.732 (Note 2)	3,600 141.732 (Note 2)	3,600 141.732 (Note 2)	3,600 141.732 (Note 2)	3,600 141.732 (Note 2)	3,600 141.732 (Note 2)	3,600 141.732 (Note 2)
				FT-R43		3,600 141.732 (Note 2)	3,600 141.732 (Note 2)	3,600 141.732 (Note 2)	3,600 141.732 (Note 2)	3,600 141.732 (Note 2)	3,600 141.732 (Note 2)	3,600 141.732 (Note 2)
				FT-H35-M2		3,600 141.732 (Note 2)	3,600 141.732 (Note 2)	3,600 141.732 (Note 2)	3,600 141.732 (Note 2)	3,600 141.732 (Note 2)	3,600 141.732 (Note 2)	3,600 141.732 (Note 2)
				FT-H20W-M1		1,600 62.992 (Note 2)	1,600 62.992 (Note 2)	1,600 62.992 (Note 2)	1,600 62.992 (Note 2)	1,600 62.992 (Note 2)	1,600 62.992 (Note 2)	1,600 62.992 (Note 2)
FT-H20-M1		1,600 62.992 (Note 2)	1,600 62.992 (Note 2)	1,600 62.992 (Note 2)	1,600 62.992 (Note 2)	1,600 62.992 (Note 2)	1,600 62.992 (Note 2)	1,600 62.992 (Note 2)				
FT-H13-FM2		3,600 141.732 (Note 2)	3,600 141.732 (Note 2)	3,600 141.732 (Note 2)	3,600 141.732 (Note 2)	3,600 141.732 (Note 2)	3,600 141.732 (Note 2)	3,600 141.732 (Note 2)				
FT-H20-J50-S		3,600 141.732 (Note 2)	3,600 141.732 (Note 2)	3,600 141.732 (Note 2)	3,600 141.732 (Note 2)	3,600 141.732 (Note 2)	3,600 141.732 (Note 2)	3,600 141.732 (Note 2)				
FT-H20-J30-S												
FT-H20-J20-S												
Side-view lens	FX-SV1		Beam axis is bent by 90°. • Ambient temperature: -60 to +300 °C -76 to +572 °F (Note 4) • Beam dia: ø2.8 mm ø0.110 in	Sensing range (mm in) [Lens on both sides]								
				Fiber	Mode	HYPR	U-LG	LONG	STD	FAST	H-SP	
				FT-43		3,600 141.732 (Note 2)	3,400 133.858	2,600 102.362	1,700 66.929	970 38.189	310 12.205	
				FT-42		3,600 141.732 (Note 2)	3,600 141.732 (Note 2)	3,600 141.732 (Note 2)	2,100 82.677	1,150 45.276	370 14.567	
				FT-42W		3,600 141.732 (Note 2)	3,500 137.795	2,700 106.299	2,000 78.740	990 38.976	320 12.598	
				FT-45X		1,600 62.992 (Note 2)	1,600 62.992 (Note 2)	1,600 62.992 (Note 2)	1,400 55.118	800 31.496	210 8.268	
				FT-R43		3,200 125.984	1,800 70.866	1,300 51.181	950 37.402	510 20.079	160 6.299	
				FT-H35-M2		3,500 137.795	1,600 62.992	1,200 47.244	780 30.709	500 19.685	150 5.906	
				FT-H20W-M1		1,600 62.992 (Note 2)	1,600 62.992 (Note 2)	1,500 59.055	950 37.402	560 22.047	190 7.480	
				FT-H20-M1		1,600 62.992 (Note 2)	1,600 62.992 (Note 2)	1,300 51.181	780 30.709	500 19.685	150 5.906	
FT-H20-J50-S		1,600 62.992 (Note 2)	960 37.795	740 29.134	450 17.717	290 11.417	80 3.150					
FT-H20-J30-S												
FT-H20-J20-S												
Expansion lens for vacuum fiber (Note 1)	FV-LE1		Sensing range increases by 4 times or more. • Ambient temperature: -60 to +350 °C -76 to +662 °F (Note 4) • Beam dia: ø3.6 mm ø0.142 in	Sensing range (mm in) [Lens on both sides] (Note 3)								
				Fiber	Mode	HYPR	U-LG	LONG	STD	FAST	H-SP	
				3,600 141.732 (Note 2)	3,600 141.732 (Note 2)	3,400 133.858	1,500 59.055	900 35.433	370 14.567			
Vacuum-resistant side-view lens (Note 1)	FV-SV2		Beam axis is bent by 90°. • Ambient temperature: -60 to +300 °C -76 to +572 °F (Note 4) • Beam dia: ø3.7 mm ø0.146 in	Sensing range (mm in) [Lens on both sides] (Note 3)								
				Fiber	Mode	HYPR	U-LG	LONG	STD	FAST	H-SP	
				3,600 141.732 (Note 2)	3,600 141.732 (Note 2)	3,400 133.858	1,500 59.055	900 35.433	370 14.567			

Notes: 1) Be careful sure to use it only after you have adjusted it sufficiently when installing the thru-beam type fiber equipped with the expansion lens, as the beam envelope becomes narrow and alignment is difficult.
 2) The fiber cable length practically limits the sensing range.
 3) The fiber cable length for the FT-H30-M1V-S is 1 m 3.28 ft. The sensing ranges in HYPR, U-LG and LONG of FX-500 series are specified considering the length of the FT-J8 atmospheric side fiber.
 4) Refer to p.79, p.81, p.92, and p.94 for the ambient temperature of fibers to be used in combination.

FIBER SENSORS
 LASER SENSORS
 PHOTO-ELECTRIC SENSORS
 MICRO PHOTO-ELECTRIC SENSORS
 AREA SENSORS
 LIGHT CURTAINS / SAFETY COMPONENTS
 PRESSURE / FLOW SENSORS
 INDUCTIVE PROXIMITY SENSORS
 PARTICULAR USE SENSORS
 SENSOR OPTIONS
 SIMPLE WIRE-SAVING UNITS
 WIRE-SAVING SYSTEMS
 MEASUREMENT SENSORS
 STATIC ELECTRICITY PREVENTION DEVICES
 LASER MARKERS
 PLC
 HUMAN MACHINE INTERFACES
 ENERGY CONSUMPTION VISUALIZATION COMPONENTS
 FA COMPONENTS
 MACHINE VISION SYSTEMS
 UV CURING SYSTEMS
 Selection Guide
 Fibers
 Fiber Amplifiers
FX-500
FX-100
FX-300
FX-410
FX-311
 FX-301-F7/
 FX-301-F

FIBER OPTIONS

Others

Designation	Model No.	Description				
Protective tube for thru-beam type fiber	FTP-500 (0.5 m 1.640 ft)	For M4 thread	Applicable fibers	FT-42 FT-42S FT-42W	FT-43 FT-H13-FM2	
	FTP-1000 (1 m 3.281 ft)			For M3 thread	FT-31 FT-31S FT-31W	FD-31 FD-31W
	FTP-1500 (1.5 m 4.921 ft)	For M6 thread			FD-61 FD-61G FD-61S FD-61W	FD-62 FD-H13-FM2
	FTP-N500 (0.5 m 1.640 ft)				For M4 thread	FD-41 FD-41W
	FTP-N1000 (1 m 3.281 ft)					
FTP-N1500 (1.5 m 4.921 ft)						
Protective tube for reflective type fiber	FDP-500 (0.5 m 1.640 ft)	For M4 thread	Applicable fibers	FD-41 FD-41W	FD-41S FD-41SW	
	FDP-1000 (1 m 3.281 ft)			For M3 thread	FT-31 FT-31S FT-31W	FD-31 FD-31W
	FDP-1500 (1.5 m 4.921 ft)	For M6 thread			FD-61 FD-61G FD-61S FD-61W	FD-62 FD-H13-FM2
	FDP-N500 (0.5 m 1.640 ft)				For M4 thread	FD-41 FD-41W
	FDP-N1000 (1 m 3.281 ft)					
FDP-N1500 (1.5 m 4.921 ft)						
Fiber bender	FB-1	The fiber bender bends the sleeve part of the fiber head at the proper radius. (Note 1)				
Universal sensor mounting stand (Note 2)	MS-AJ1-F	Horizontal mounting type	Mounting stand assembly for fiber (For M3, M4 or M6 threaded head fiber)			
	MS-AJ2-F	Vertical mounting type				
Liquid inflow prevention joint (Note 2)	MS-FX-01Y	Applicable fibers	FD-HF40Y FD-F41Y	This joint suppresses false operations due to liquid slip-in from the top of the protective tube.		
Protective tube extension joint (Note 2)	MS-FX-02Y			The protective tube can be extended.		
Fiber mounting joint (Note 2)	MS-FX-03Y			The joint is used for mounting fibers on a tank.		
Single core holder	FX-AT15A	The incident light intensity may vary when using a multi-core fiber or a thin type sharp bending fiber. This holder suppresses the variation in the incident light intensity. (Brown)				
Reflector	RF-210	Used with FR-Z50HW.				
	RF-220	Refer to p.90 for the sensing range when FR-Z50HW is used in combination with a reflector.				
	RF-230					

Notes: 1) Do not bend the sleeve part of any side-view type fiber or ultra-small diameter head type fiber.
2) The joint internal ferrule (MS-FX-YF) is available as a spare part. A distorted ferrule may result in leakage.

Liquid inflow prevention joint

- MS-FX-01Y

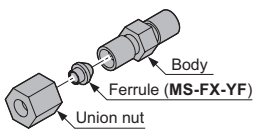

Protective tube extension joint

- MS-FX-02Y

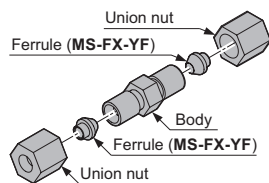

Fiber mounting joint

- MS-FX-03Y

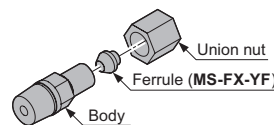

Reflector

- RF-210

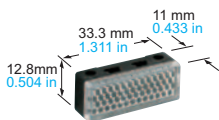

- RF-220

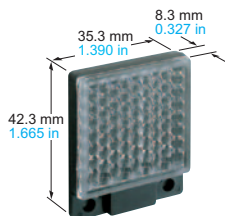

- RF-230

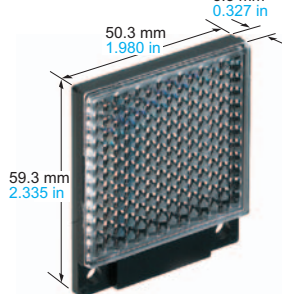

Protective tube

- FTP-□
- FDP-□

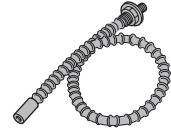

Fiber bender

- FB-1

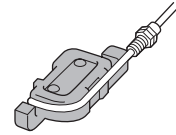

Universal sensor mounting stand

Using the arm which enables adjustment in the horizontal direction, sensing can also be done from above an assembly line.

- MS-AJ1-F

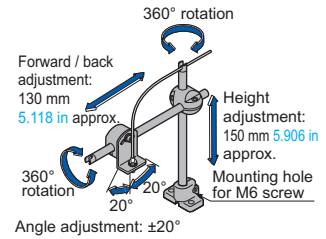

- MS-AJ2-F

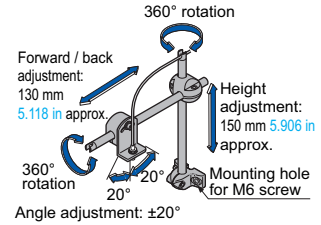

Single core holder

- FX-AT15A



SPECIFICATIONS

Item	Model No.	Type	Standard type	2-output type	Cable type (Analog output type)	
		NPN output	FX-501	FX-502	FX-505-C2	
		PNP output	FX-501P	FX-502P	FX-505P-C2	
Supply voltage		12 to 24 V DC ⁺¹⁰ ₋₁₅ % Ripple P-P 10 % or less				
Power consumption		Normal operation: 960 mW or less (current consumption 40 mA or less at 24 V supply voltage, excluding analog output of cable type) ECO mode: 680 mW or less (current consumption 28 mA or less at 24 V supply voltage, excluding analog output of cable type)				
Output (2-output type and cable type: Output 1, Output 2)		<NPN output type> NPN open-collector transistor		<PNP output type> PNP open-collector transistor		
		<ul style="list-style-type: none"> Maximum sink current: 100 mA (2-output type and cable type are 50 mA) (Note 2) Applied voltage: 30 V DC or less (between output and 0 V) Residual voltage: 2 V or less (Note 3) (at maximum sink current) 		<ul style="list-style-type: none"> Maximum source current: 100 mA (2-output type and cable type are 50 mA) (Note 2) Applied voltage: 30 V DC or less (between output and +V) Residual voltage: 2 V or less (Note 3) (at maximum source current) 		
		Output points	1 point	2 points		
		Output operation	Switchable either Light-ON or Dark-ON by L/D mode			
Short-circuit protection		Incorporated				
Response time		H-SP: 25 μs or less, FAST: 60 μs or less, STD: 250 μs or less, LONG: 2 ms or less, U-LG: 4 ms or less, HYPR: 24 ms or less, selectable				
Analog output (Cable type only)		Output current: 4 to 20 mA approx. [H-SP, FAST, STD: At 0 to 4,000 digits, LONG: At 0 to 8,000 digits (Note 4)], Response time: 2 ms or less, Zero point: Within 4 mA ±1 % F.S., Span: Within 16 mA ±5 % F.S., Linearity: Within ±3 % F.S., Load resistance: 0 to 250 Ω				
External input (2-output type only, switchable with Output 2)		————	<NPN output type> NPN non-contact input	<PNP output type> PNP non-contact input		
Possible external input function		————	Emission halt / Teaching (Full-auto, Limit, 2-point) / Logic operation setting / Copy lock / Display adjustment / Data bank load / Data bank save, selectable			
Sensitivity setting		2-point teaching / Limit teaching / Full-auto teaching / Manual adjustment				
Incident light intensity display range		H-SP / FAST / STD: 0 to 4,000, LONG: 0 to 8,000, U-LG / HYPR: 0 to 9,999				
Timer function		Incorporated with variable OFF-delay / ON-delay / One-shot / ON OFF-delay / ON-delay • One-shot timer, switchable either effective or ineffective		<Output 1> Incorporated with variable OFF-delay / ON-delay / One-shot / ON OFF-delay / ON-delay • One-shot timer, switchable either effective or ineffective		
		Timer period		<Output 2> Incorporated with variable OFF-delay / ON-delay / One-shot timer, switchable either effective or ineffective		
Light emitting amount selection function		Incorporated, 3 levels (each level 25 to 100 %) + Auto setting [1 level (25 to 100 %) when using H-SP mode]				
Interference prevention function		Incorporated (Note 5), selectable either automatic interference prevention or different frequency				
Various settings		Hysteresis setting / Shift amount setting / Emission power setting / Display turning setting / ECO setting / Data bank loading saving setting / Copying setting / Code setting / Reset setting / Logical calculation setting / Threshold tracking setting, etc.				
Protection		IP40 (IEC)				
Ambient temperature		-10 to +55 °C +14 to +131 °F [If 4 to 7 units are mounted in cascade: -10 to +50 °C +14 to +122 °F or if 8 to 16 units (cable type: 8 to 12 units) are mounted in cascade: -10 to +45 °C +14 to +113 °F] (No dew condensation or icing allowed), Storage: -20 to +70 °C -4 to +158 °F				
Emitting element (modulated)		Red LED (Peak emission wavelength: 643 nm 0.025 mil)				
Material		Enclosure, Case cover: Polycarbonate, Switch: TPEE				
Cable		————	0.2 mm ² 6-core cabtyre cable, 2 m 6.562 ft long			
Cable extension		————	Extension up to total 100 m 328.084 ft is possible with 0.3 mm ² , or more, cable. (however, supply voltage 12 V DC)			
Weight		Net weight: 15 g approx., Gross weight: 70 g approx.		Net weight: 60 g approx., Gross weight: 100 g approx.		
Accessory		FX-MB1 (Amplifier protection seal): 1 set				

Notes: 1) Where measurement conditions have not been specified precisely, the conditions used were an ambient temperature of +23 °C **+73.4 °F**.

- 50 mA max. if 5 or more standard types are connected together. (25 mA in case of 2-output type and cable type)
- In case of using the quick-connection cable (cable length 5 m **16.404 ft**) (optional).
- If display adjustment was conducted, it is not in this range.
- Number of sensor heads which is possible to be mounted closely in auto interference prevention function depends on response time as shown in table below. Number of sensor heads which is possible to be mounted closely in different frequency Interference prevention function is up to 3 units.

• Number of sensor heads mountable closely (Unit: set)

Response time	H-SP	FAST	STD	LONG	U-LG	HYPR
IP-1	0	2	4	8	8	12

FIBER SENSORS

LASER SENSORS

PHOTO-ELECTRIC SENSORS

MICRO PHOTO-ELECTRIC SENSORS

AREA SENSORS

LIGHT CURTAINS / SAFETY COMPONENTS

PRESSURE / FLOW SENSORS

INDUCTIVE PROXIMITY SENSORS

PARTICULAR USE SENSORS

SENSOR OPTIONS

SIMPLE WIRE-SAVING UNITS

WIRE-SAVING SYSTEMS

MEASUREMENT SENSORS

STATIC ELECTRICITY PREVENTION DEVICES

LASER MARKERS

PLC

HUMAN MACHINE INTERFACES

ENERGY CONSUMPTION VISUALIZATION COMPONENTS

FA COMPONENTS

MACHINE VISION SYSTEMS

UV CURING SYSTEMS

Selection Guide

Fibers

Fiber Amplifiers

FX-500**FX-100****FX-300****FX-410****FX-311****FX-301-F7/ FX-301-F**

I/O CIRCUIT AND WIRING DIAGRAMS

FX-501

NPN output type

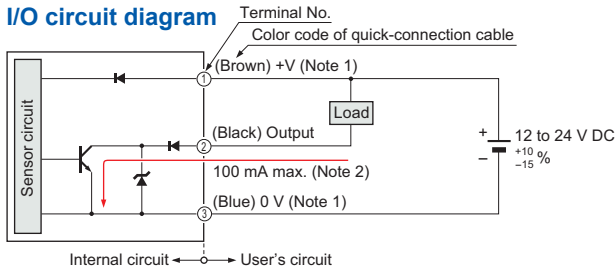

Notes: 1) The quick-connection sub cable does not have +V (brown) and 0 V (blue). The power is supplied from the connector of the main cable.
2) 50 mA max., if five amplifiers or more, are connected together.

Wiring diagram

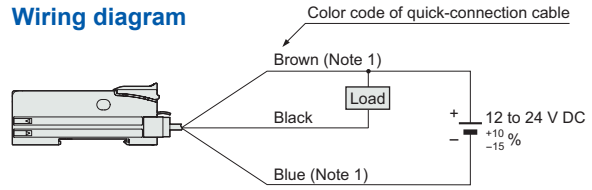

Note: The quick-connection sub cable does not have a brown and a blue lead wire.

Terminal arrangement diagram

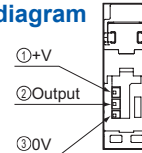

FX-501P

PNP output type

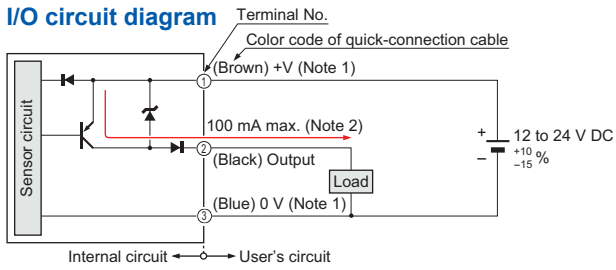

Notes: 1) The quick-connection sub cable does not have +V (brown) and 0 V (blue). The power is supplied from the connector of the main cable.
2) 50 mA max., if five amplifiers or more, are connected together.

Wiring diagram

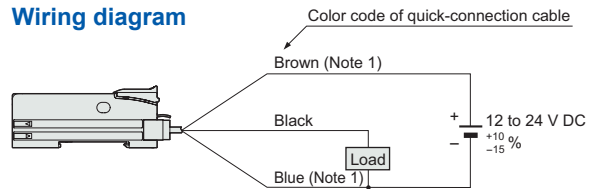

Note: The quick-connection sub cable does not have a brown and a blue lead wire.

Terminal arrangement diagram

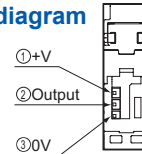

FX-502

NPN output type

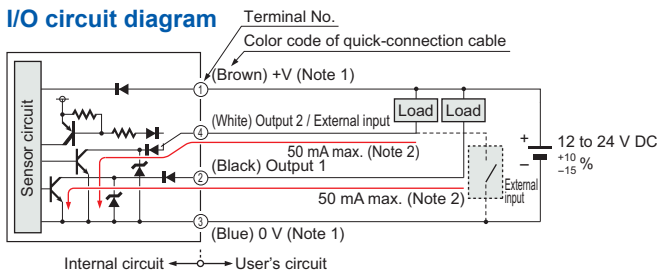

Notes: 1) The quick-connection sub cable does not have +V (brown) and 0 V (blue). The power is supplied from the connector of the main cable.
2) 25 mA max., if five amplifiers or more, are connected together.

Wiring diagram

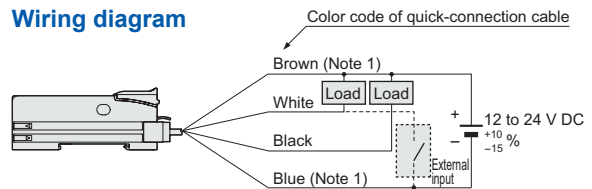

Note: The quick-connection sub cable does not have a brown and a blue lead wire.

Terminal arrangement diagram

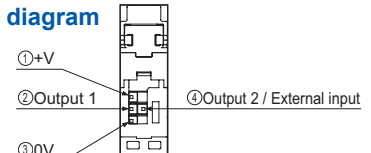

FX-502P

PNP output type

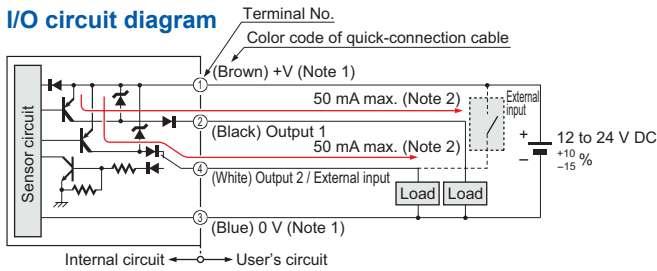

Notes: 1) The quick-connection sub cable does not have +V (brown) and 0 V (blue). The power is supplied from the connector of the main cable.
2) 25 mA max., if five amplifiers or more, are connected together.

Wiring diagram

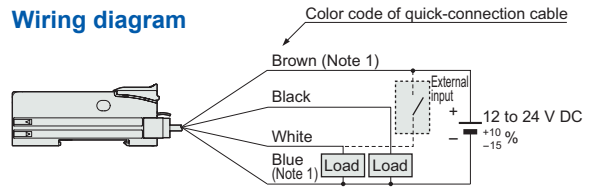

Note: The quick-connection sub cable does not have a brown and a blue lead wire.

Terminal arrangement diagram

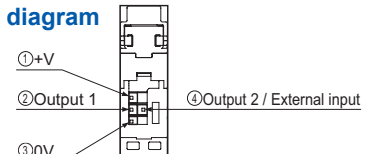

I/O CIRCUIT AND WIRING DIAGRAMS

FX-505-C2

NPN output type

I/O circuit diagram

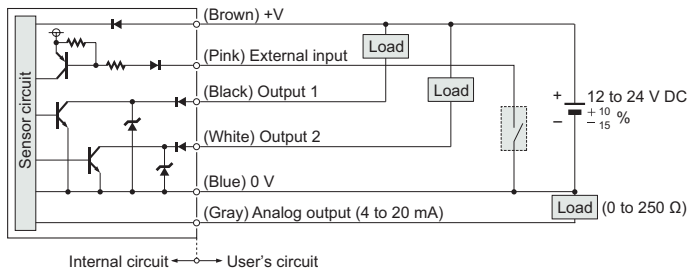

Wiring diagram

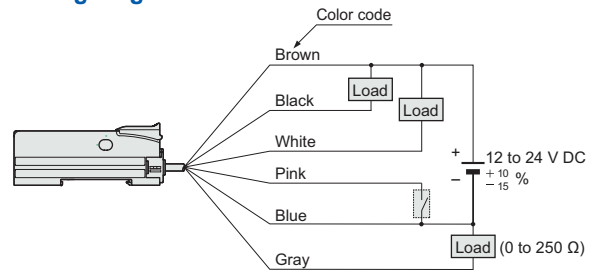

FX-505P-C2

PNP output type

I/O circuit diagram

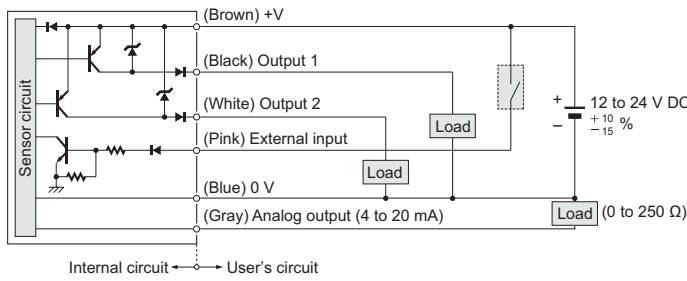

Wiring diagram

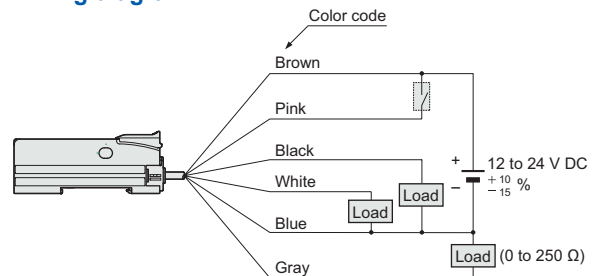

FIBER SENSORS

LASER SENSORS

PHOTO-ELECTRIC SENSORS

MICRO PHOTO-ELECTRIC SENSORS

AREA SENSORS

LIGHT CURTAINS / SAFETY COMPONENTS

PRESSURE / FLOW SENSORS

INDUCTIVE PROXIMITY SENSORS

PARTICULAR USE SENSORS

SENSOR OPTIONS

SIMPLE WIRE-SAVING UNITS

WIRE-SAVING SYSTEMS

MEASUREMENT SENSORS

STATIC ELECTRICITY PREVENTION DEVICES

LASER MARKERS

PLC

HUMAN MACHINE INTERFACES

ENERGY CONSUMPTION VISUALIZATION COMPONENTS

FA COMPONENTS

MACHINE VISION SYSTEMS

UV CURING SYSTEMS

Selection Guide

Fibers

Fiber Amplifiers

FX-500

FX-100

FX-300

FX-410

FX-311

FX-301-F7/ FX-301-F

SENSING CHARACTERISTICS (TYPICAL)

Thru-beam type Parallel deviation Sensing characteristics are listed in the alphabetic order of Model No.

FT-140 Thru-beam type

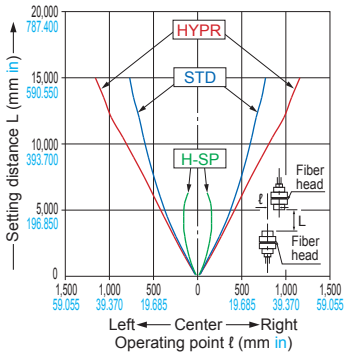

FT-30 Thru-beam type

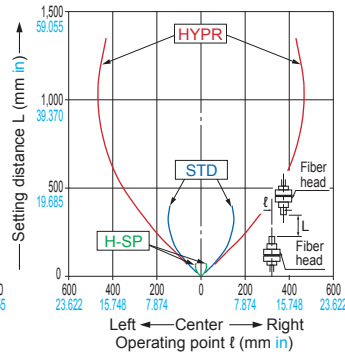

FT-31 Thru-beam type

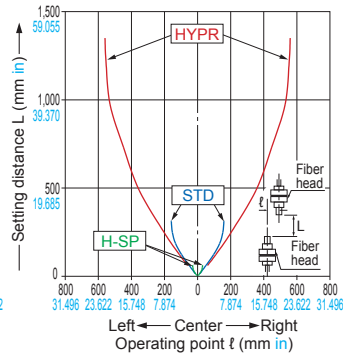

FT-31S Thru-beam type

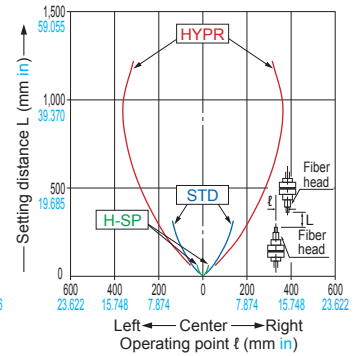

FT-31W Thru-beam type

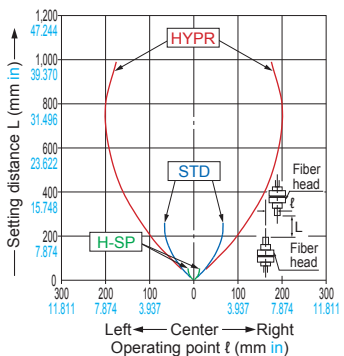

FT-40 Thru-beam type

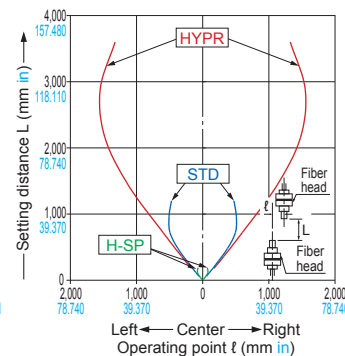

FT-42 Thru-beam type

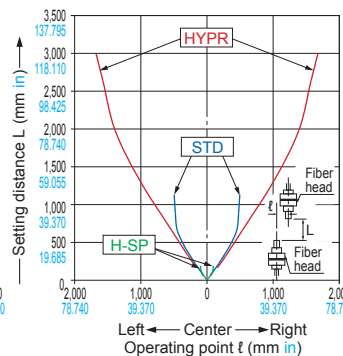

FT-42S Thru-beam type

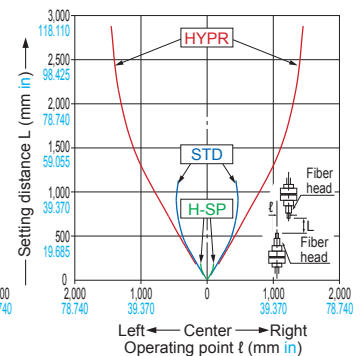

FT-42W Thru-beam type

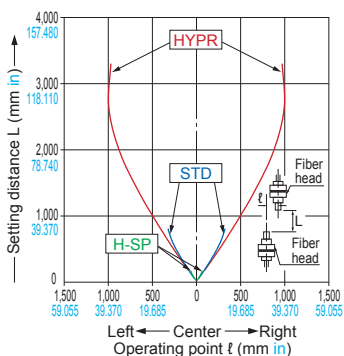

FT-43 Thru-beam type

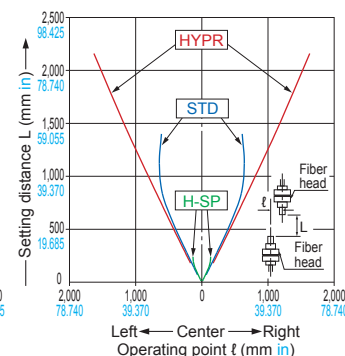

FT-45X Thru-beam type

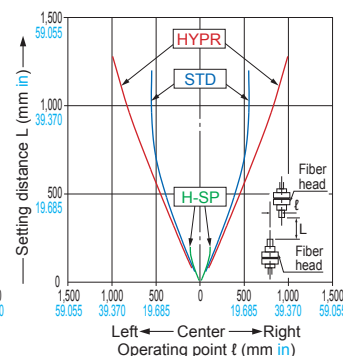

FT-A11 Thru-beam type

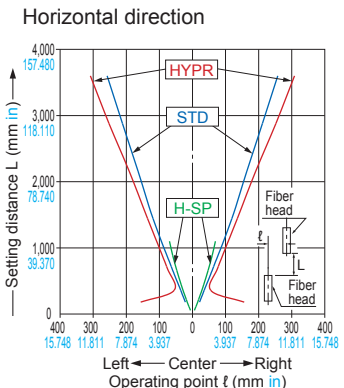

FT-A11W Thru-beam type

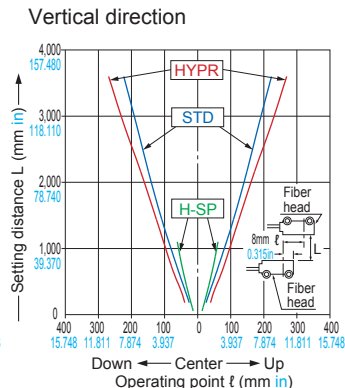

FT-A11W Thru-beam type

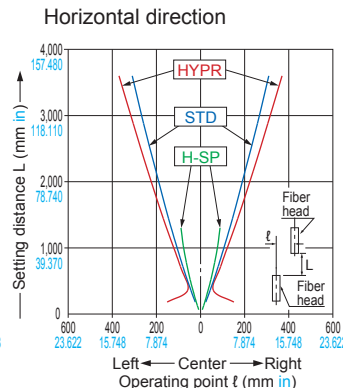

FT-A11W Thru-beam type

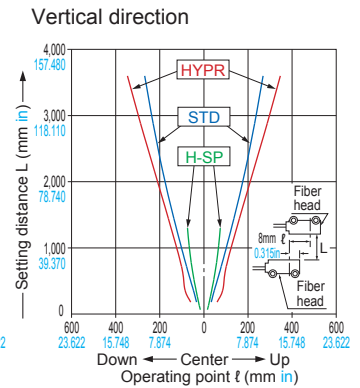

FIBER SENSORS

LASER SENSORS

PHOTO-ELECTRIC SENSORS

MICRO PHOTO-ELECTRIC SENSORS

AREA SENSORS

LIGHT CURTAINS/SAFETY COMPONENTS

PRESSURE/FLOW SENSORS

INDUCTIVE PROXIMITY SENSORS

PARTICULAR USE SENSORS

SENSOR OPTIONS

SIMPLE WIRE-SAVING UNITS

WIRE-SAVING SYSTEMS

MEASUREMENT SENSORS

STATIC ELECTRICITY PREVENTION DEVICES

LASER MARKERS

PLC

HUMAN MACHINE INTERFACES

ENERGY CONSUMPTION VISUALIZATION COMPONENTS

FA COMPONENTS

MACHINE VISION SYSTEMS

UV CURING SYSTEMS

Selection Guide

Fibers

Fiber Amplifiers

FX-500

FX-100

FX-300

FX-410

FX-311

FX-301-F7/

FX-301-F

SENSING CHARACTERISTICS (TYPICAL)

Thru-beam type Parallel deviation Sensing characteristics are listed in the alphabetic order of Model No. (Models with same sensing characteristics are grouped together.)

FT-A32

Thru-beam type

Horizontal direction

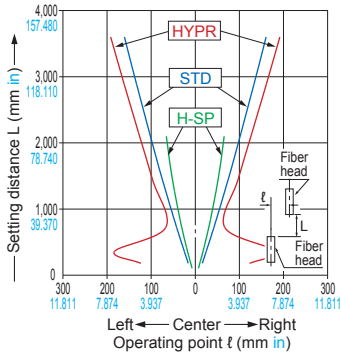

Vertical direction

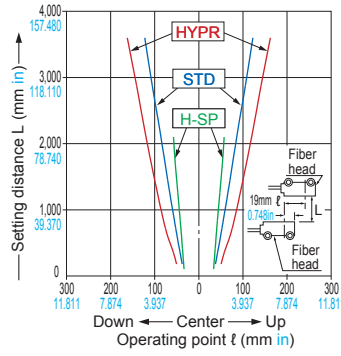

FT-A32W

Thru-beam type

Horizontal direction

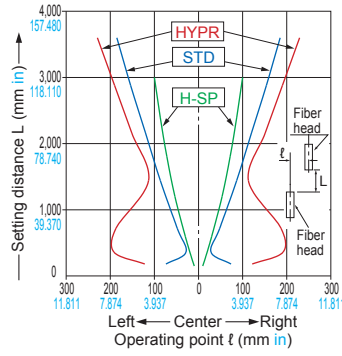

Vertical direction

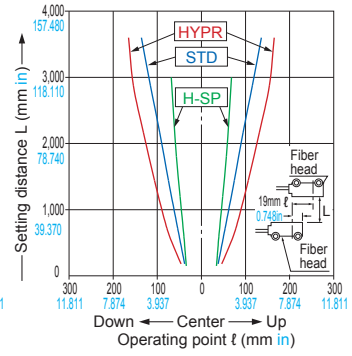

FT-AL05

Thru-beam type

Horizontal direction

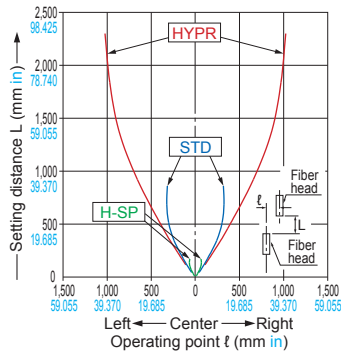

Vertical direction

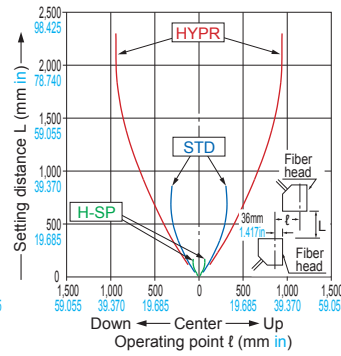

FT-E13

Thru-beam type

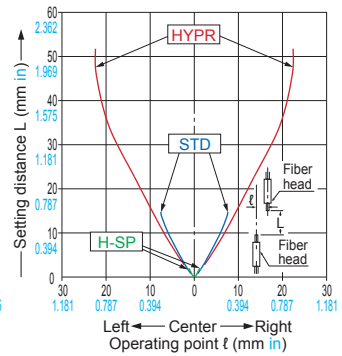

FT-E23

Thru-beam type

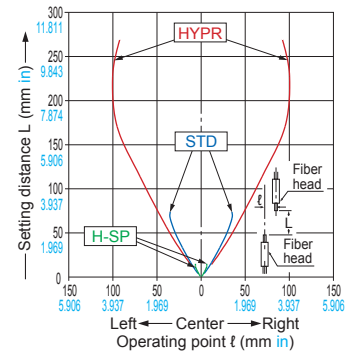

FT-H13-FM2

Thru-beam type

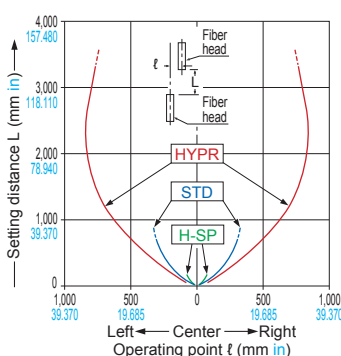

FT-H20-J20-S FT-H20-J30-S FT-H20-J50-S

Thru-beam type

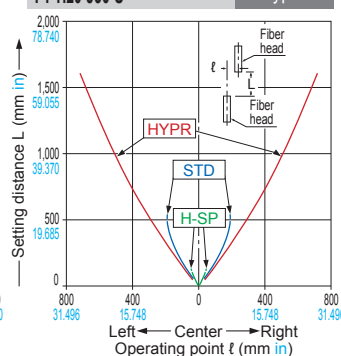

FT-H20-M1

Thru-beam type

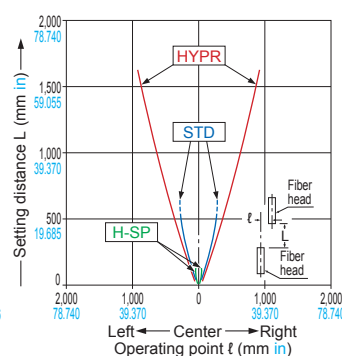

FT-H20-VJ50-S FT-H20-VJ80-S

Thru-beam type

Horizontal direction

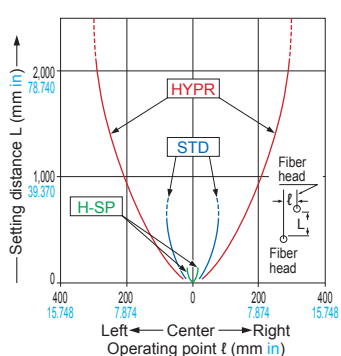

Vertical direction

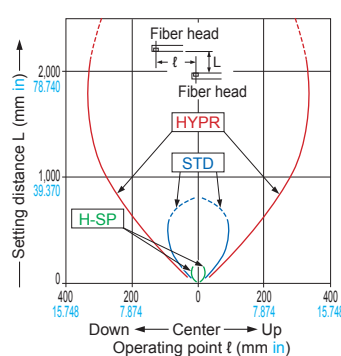

FT-H20W-M1

Thru-beam type

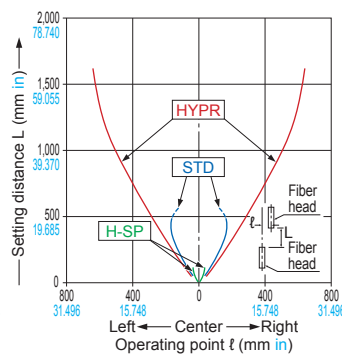

FT-H30-M1V-S

Thru-beam type

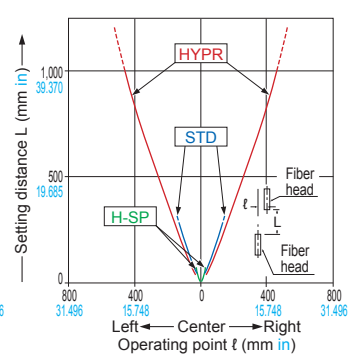

FIBER SENSORS

LASER SENSORS

PHOTO-ELECTRIC SENSORS

MICRO PHOTO-ELECTRIC SENSORS

AREA SENSORS

LIGHT CURTAINS / SAFETY COMPONENTS

PRESSURE / FLOW SENSORS

INDUCTIVE PROXIMITY SENSORS

PARTICULAR USE SENSORS

SENSOR OPTIONS

SIMPLE WIRE-SAVING UNITS

WIRE-SAVING SYSTEMS

MEASUREMENT SENSORS

STATIC ELECTRICITY PREVENTION DEVICES

LASER MARKERS

PLC

HUMAN MACHINE INTERFACES

ENERGY CONSUMPTION VISUALIZATION COMPONENTS

FA COMPONENTS

MACHINE VISION SYSTEMS

UV CURING SYSTEMS

Selection Guide

Fibers

Fiber Amplifiers

FX-500

FX-100

FX-300

FX-410

FX-311

FX-301-F7/ FX-301-F

SENSING CHARACTERISTICS (TYPICAL)

Thru-beam type Parallel deviation

Sensing characteristics are listed in the alphabetic order of Model No. (Models with same sensing characteristics are grouped together.)

FT-H35-M2 Thru-beam type
FT-H35-M2S6

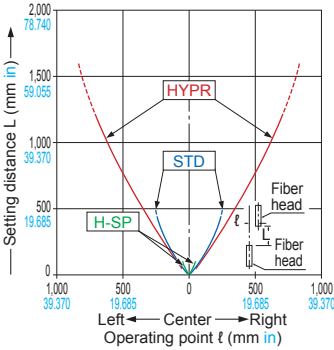

FT-HL80Y Thru-beam type

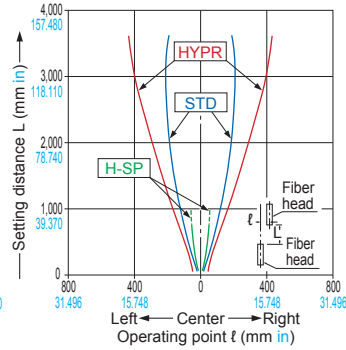

FT-KS40 Thru-beam type

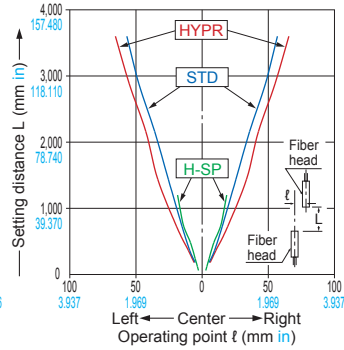

FT-KV26 Thru-beam type

Horizontal direction

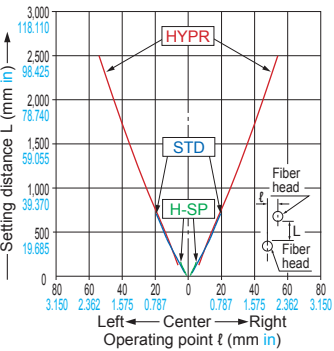

Vertical direction

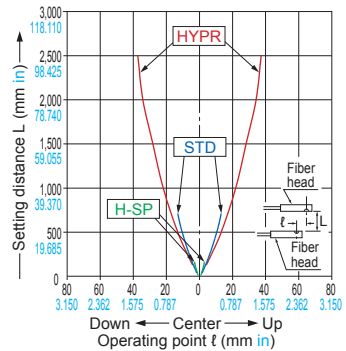

FT-KV40 Thru-beam type

Horizontal direction

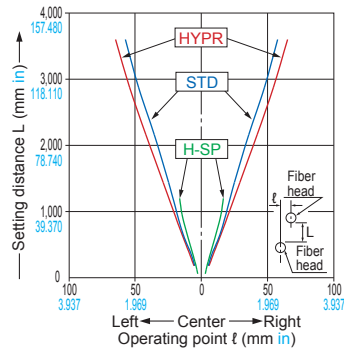

Vertical direction

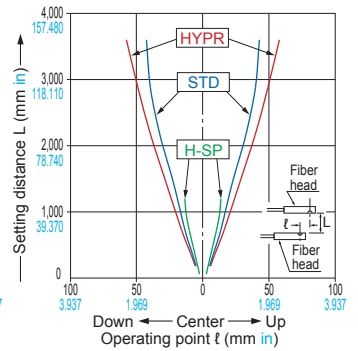

FT-KV40W Thru-beam type

Horizontal direction

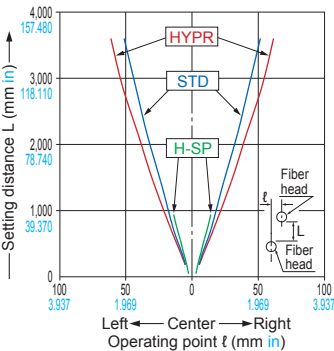

Vertical direction

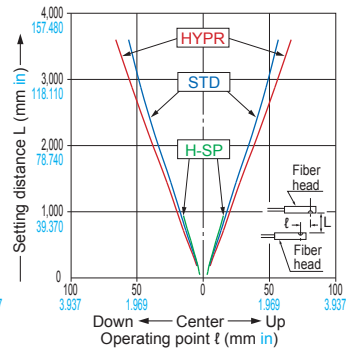

FT-L80Y Thru-beam type

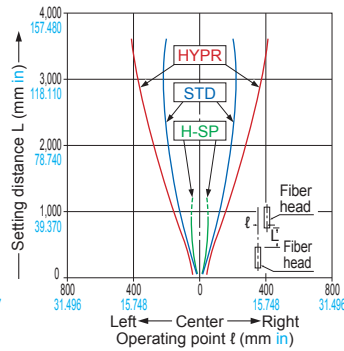

FT-R40 Thru-beam type

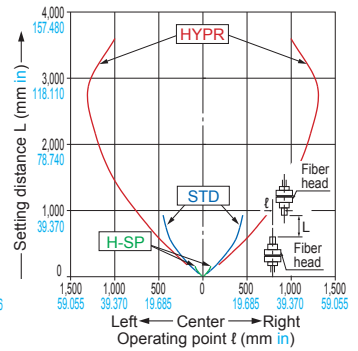

FX-500

FT-R41W Thru-beam type

Horizontal direction

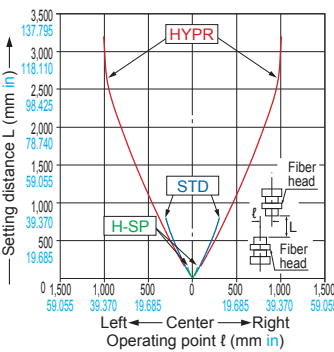

Vertical direction

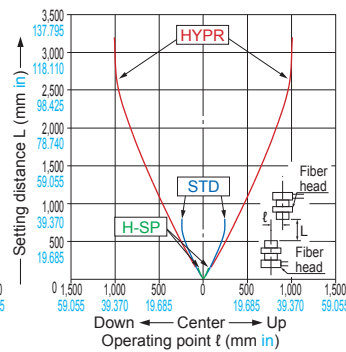

FT-R42W Thru-beam type

Horizontal direction

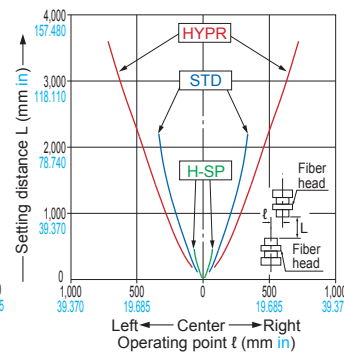

Vertical direction

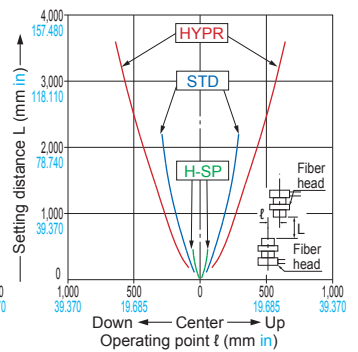

FX-100

FX-300

FX-410

FX-311

FX-301-F7/

FX-301-F

FX-301-F

FX-301-F

FX-301-F

FX-301-F

FX-301-F

FX-301-F

FX-301-F

FX-301-F

FX-301-F

FX-301-F

SENSING CHARACTERISTICS (TYPICAL)

Thru-beam type Parallel deviation Sensing characteristics are listed in the alphabetic order of Model No.

FT-R44Y Thru-beam type

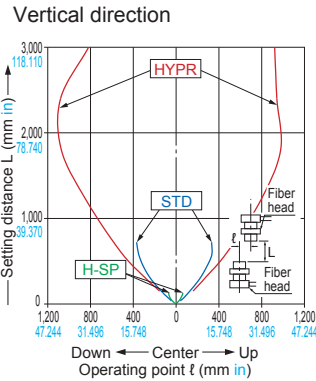
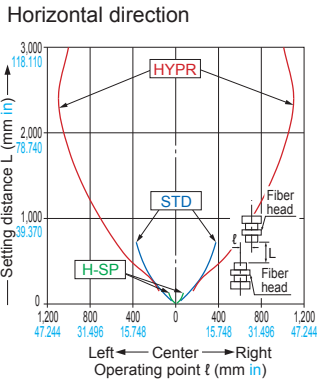

FT-R60Y Thru-beam type

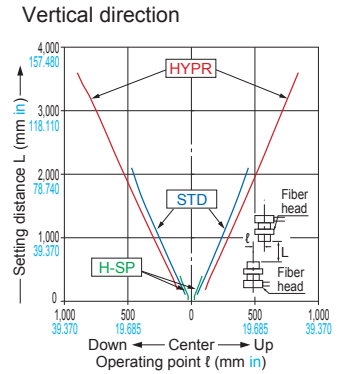
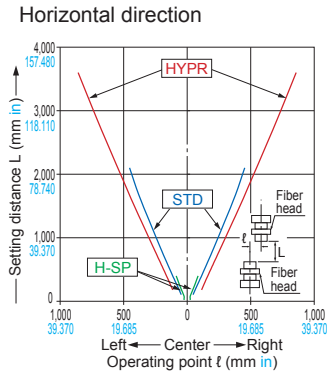

FT-S11 Thru-beam type

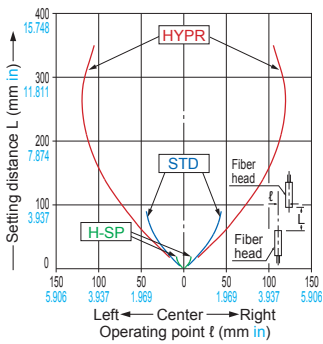

FT-S20 Thru-beam type

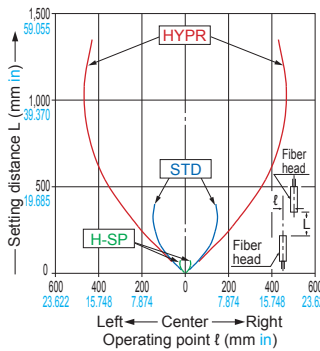

FT-S21 Thru-beam type

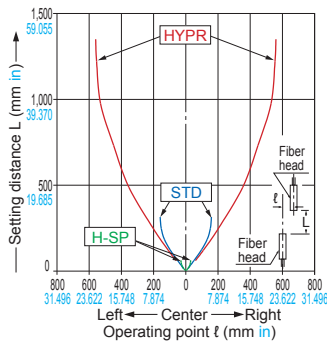

FT-S21W Thru-beam type

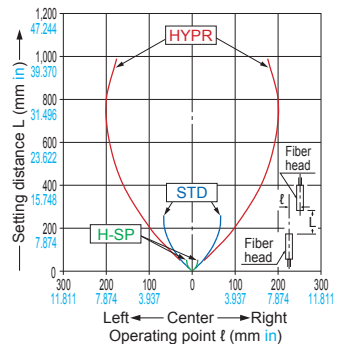

FT-S30 Thru-beam type

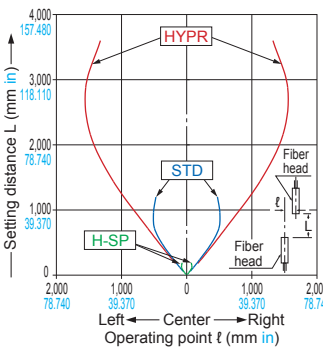

FT-S31W Thru-beam type

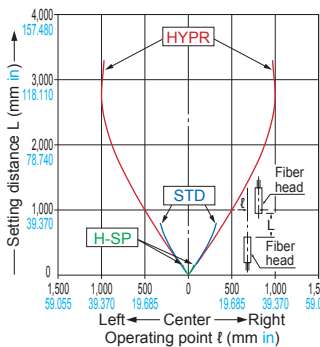

FT-S32 Thru-beam type

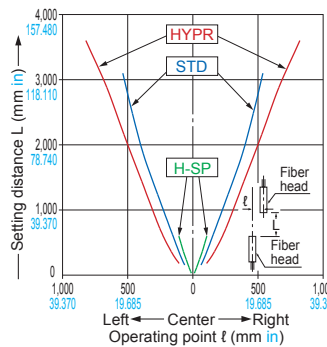

FT-V23 Thru-beam type

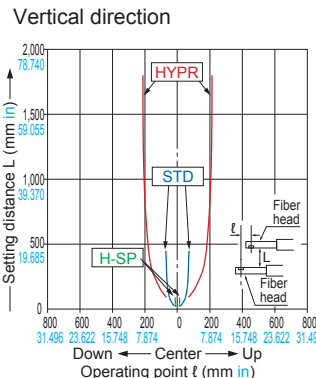
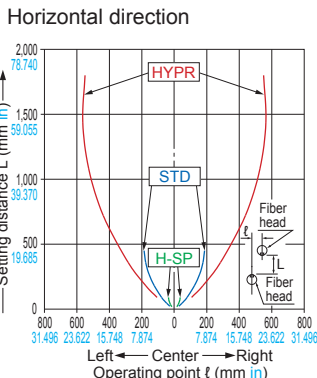

FT-V24W Thru-beam type

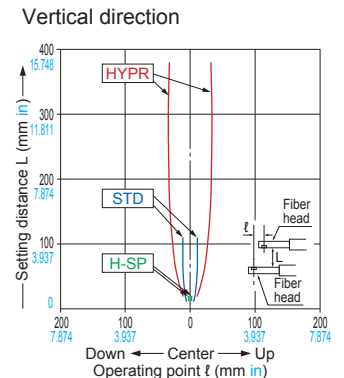
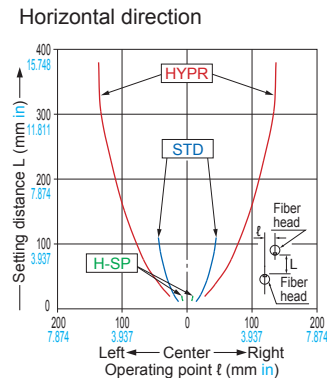

FIBER SENSORS

LASER SENSORS

PHOTO-ELECTRIC SENSORS

MICRO PHOTO-ELECTRIC SENSORS

AREA SENSORS

LIGHT CURTAINS / SAFETY COMPONENTS

PRESSURE / FLOW SENSORS

INDUCTIVE PROXIMITY SENSORS

PARTICULAR USE SENSORS

SENSOR OPTIONS

WIRE-SAVING UNITS

WIRE-SAVING SYSTEMS

MEASUREMENT SENSORS

STATIC ELECTRICITY PREVENTION DEVICES

LASER MARKERS

PLC

HUMAN MACHINE INTERFACES

ENERGY CONSUMPTION VISUALIZATION COMPONENTS

FA COMPONENTS

MACHINE VISION SYSTEMS

UV CURING SYSTEMS

Selection Guide

Fibers

Fiber Amplifiers

FX-500

FX-100

FX-300

FX-410

FX-311

FX-301-F / FX-301-F

SENSING CHARACTERISTICS (TYPICAL)

Thru-beam type Parallel deviation Sensing characteristics are listed in the alphabetic order of Model No.

FT-V25

Thru-beam type

Horizontal direction

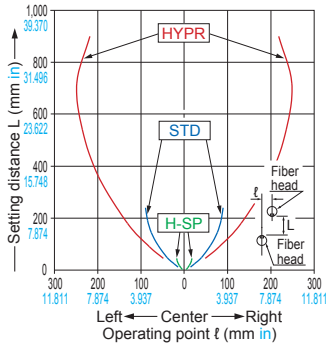

Vertical direction

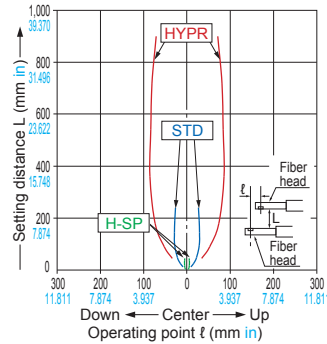

FT-V30

Thru-beam type

Horizontal direction

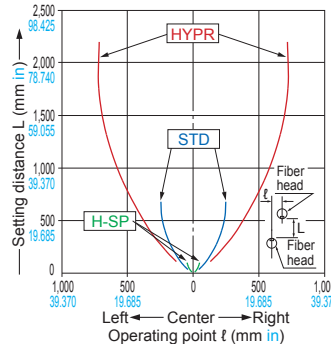

Vertical direction

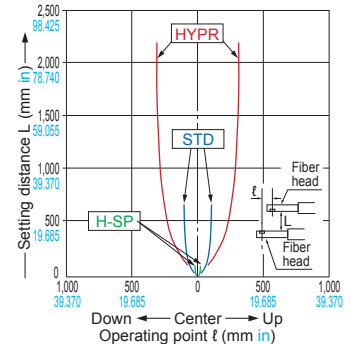

FT-V40

Thru-beam type

Horizontal direction

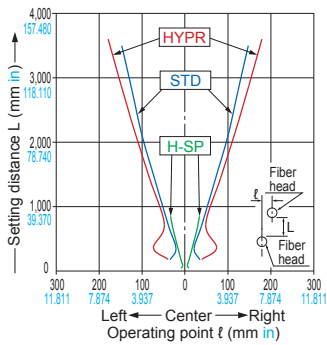

Vertical direction

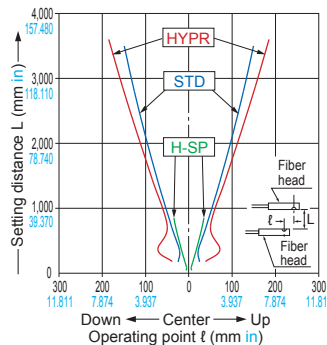

FT-V80Y

Thru-beam type

Horizontal direction

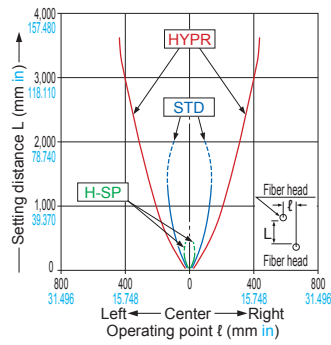

Vertical direction

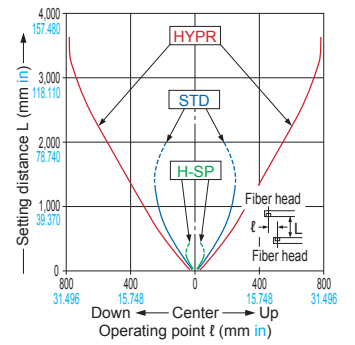

FT-Z20HBW

Thru-beam type

Horizontal direction

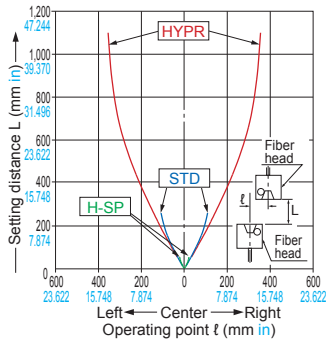

Vertical direction

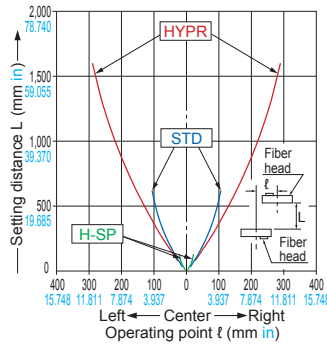

Horizontal direction

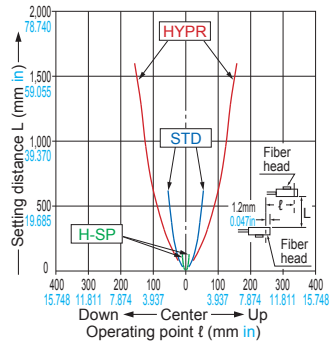

Vertical direction



FX-500

FX-100

FX-300

FX-410

FX-311

FX-301-F7/ FX-301-F

FT-Z30

Thru-beam type

Horizontal direction

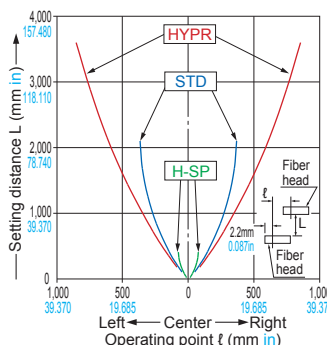

Vertical direction

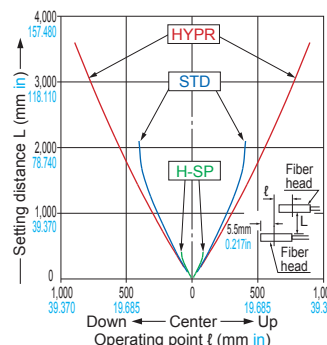

FT-Z30E

Thru-beam type

Horizontal direction

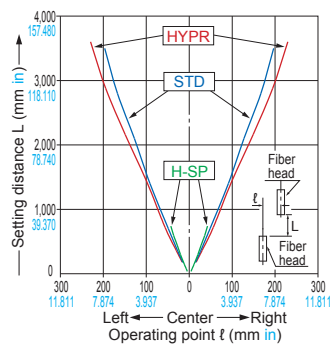

Vertical direction

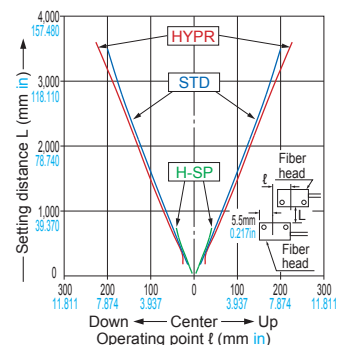

SENSING CHARACTERISTICS (TYPICAL)

Thru-beam type Parallel deviation Sensing characteristics are listed in the alphabetic order of Model No.

FT-Z30EW

Thru-beam type

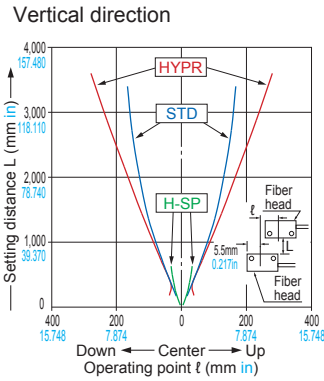
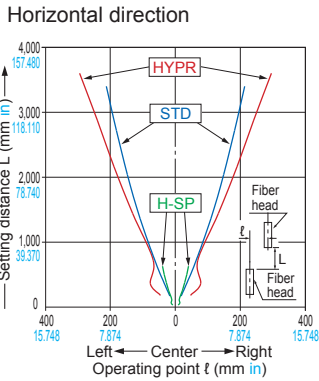

FT-Z30H

Thru-beam type

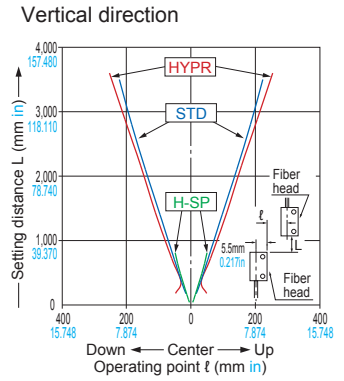
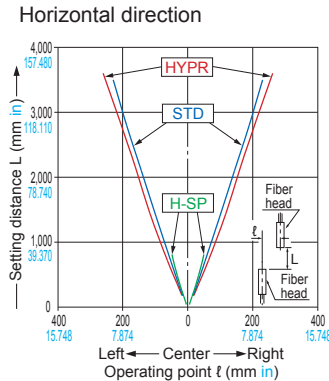

FT-Z30HW

Thru-beam type

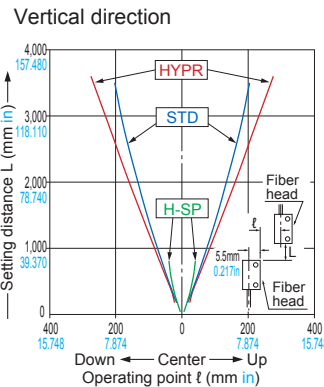
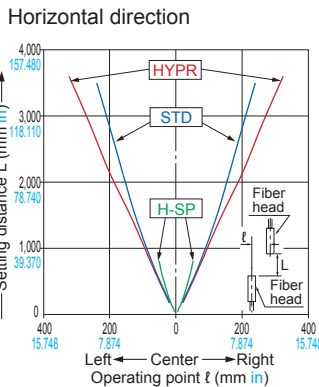

FT-Z30W

Thru-beam type

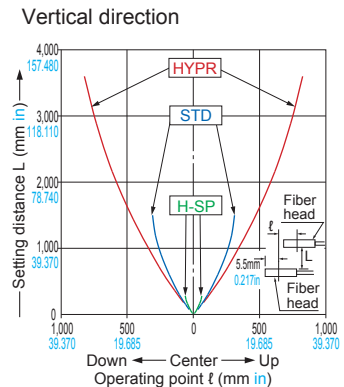
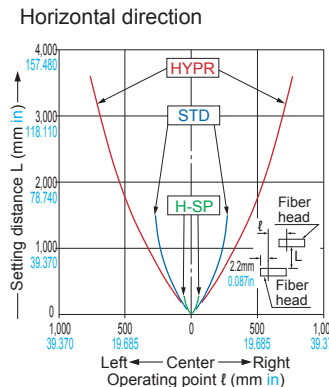

FT-Z40W

Thru-beam type

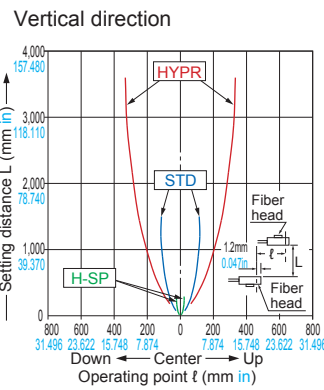
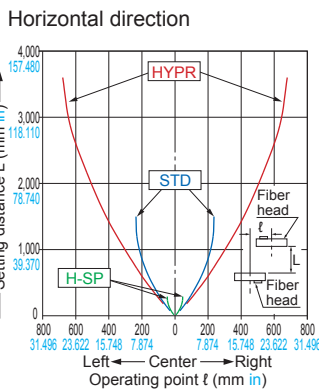

FT-Z40HBW

Thru-beam type

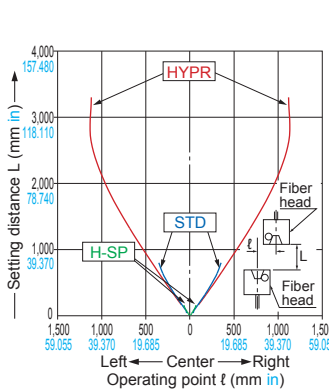

FT-Z802Y

Thru-beam type

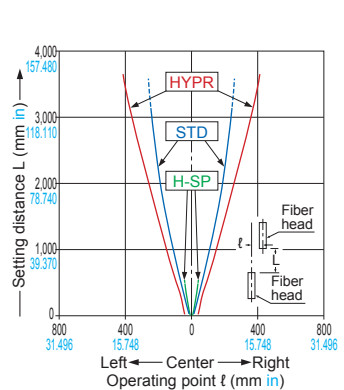

Retroreflective type Parallel deviation Sensing characteristics are listed in the alphabetic order of the Model No.

FR-KZ22E

Retroreflective type

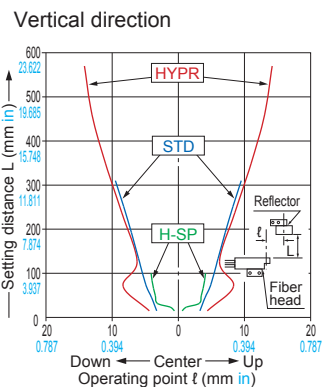
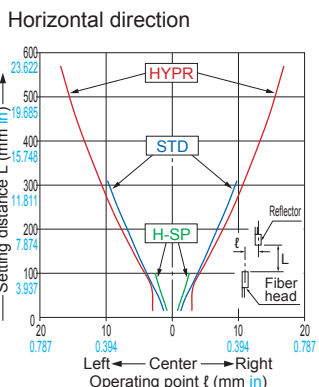

FR-KZ50E

Retroreflective type

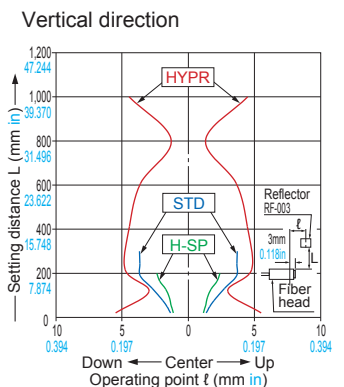
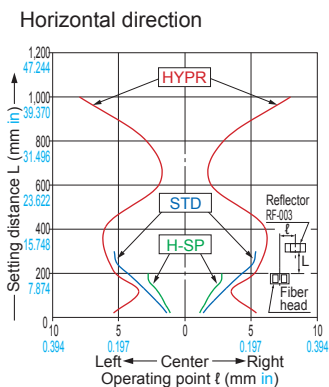

FIBER SENSORS

LASER SENSORS

PHOTO-ELECTRIC SENSORS

MICRO PHOTO-ELECTRIC SENSORS

AREA SENSORS

LIGHT CURTAINS / SAFETY COMPONENTS

PRESSURE / FLOW SENSORS

INDUCTIVE PROXIMITY SENSORS

PARTICULAR USE SENSORS

SENSOR OPTIONS

SIMPLE WIRE-SAVING UNITS

WIRE-SAVING SYSTEMS

MEASUREMENT SENSORS

STATIC ELECTRICITY PREVENTION DEVICES

LASER MARKERS

PLC

HUMAN MACHINE INTERFACES

ENERGY CONSUMPTION VISUALIZATION COMPONENTS

FA COMPONENTS

MACHINE VISION SYSTEMS

UV CURING SYSTEMS

Selection Guide

Fibers

Fiber Amplifiers

FX-500

FX-100

FX-300

FX-410

FX-311

FX-301-F7/ FX-301-F

SENSING CHARACTERISTICS (TYPICAL)

Retroreflective type Parallel deviation Sensing characteristics are listed in the alphabetic order of the Model No.

FR-KZ50H Retroreflective type

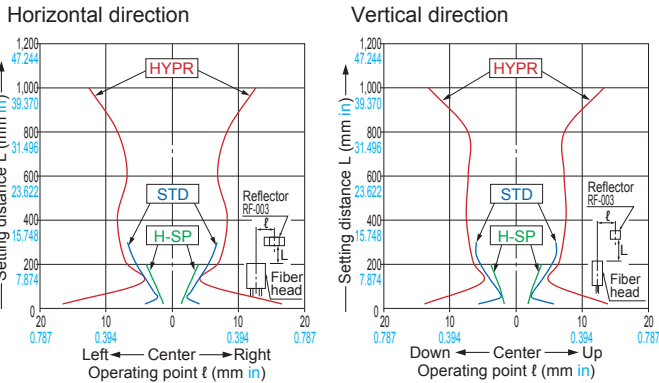

FR-Z50HW Retroreflective type

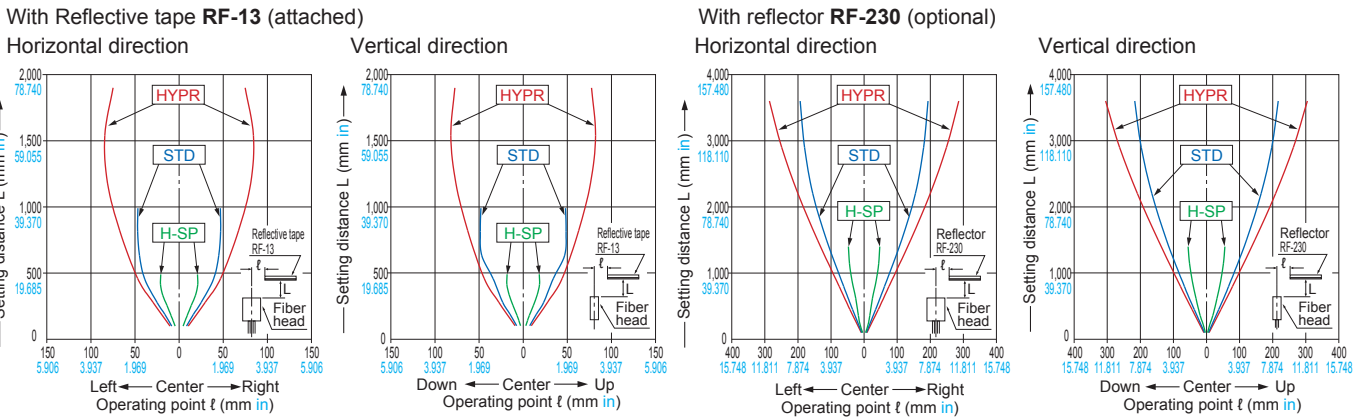

Reflective type Sensing field Sensing characteristics are listed in the alphabetic order of the Model No.

FD-30 Reflective type **FD-31** Reflective type

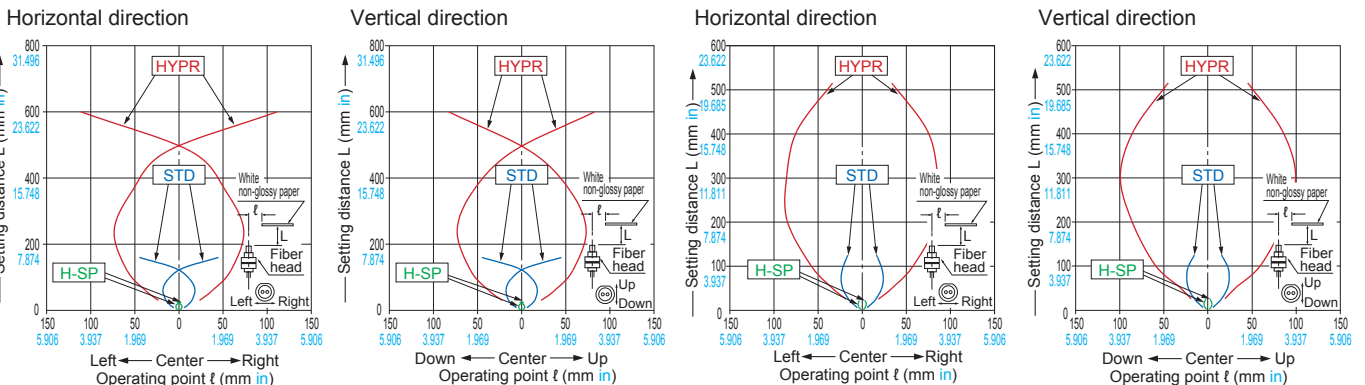

FD-31W Reflective type **FD-32G** Reflective type

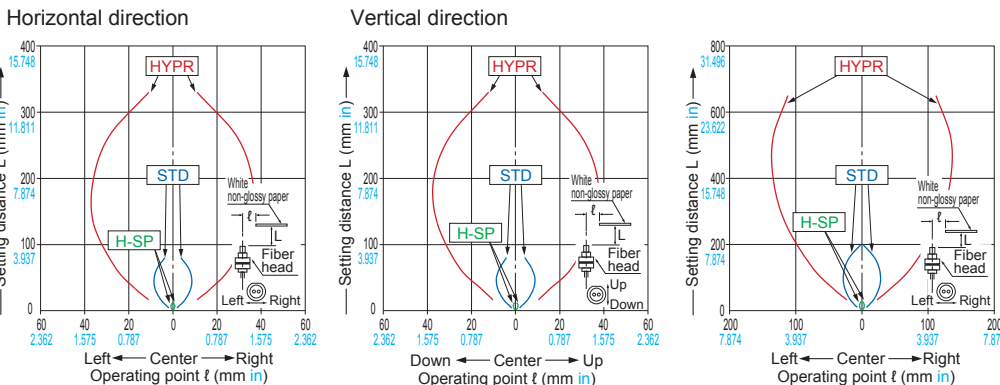

FIBER SENSORS
LASER SENSORS
PHOTO-ELECTRIC SENSORS
MICRO PHOTO-ELECTRIC SENSORS
AREA SENSORS
LIGHT CURTAINS / SAFETY COMPONENTS
PRESSURE / FLOW SENSORS
INDUCTIVE PROXIMITY SENSORS
PARTICULAR USE SENSORS
SENSOR OPTIONS

SIMPLE WIRE-SAVING UNITS
WIRE-SAVING SYSTEMS
MEASUREMENT SENSORS
STATIC ELECTRICITY PREVENTION DEVICES
LASER MARKERS
PLC
HUMAN MACHINE INTERFACES
ENERGY CONSUMPTION VISUALIZATION COMPONENTS
FA COMPONENTS
MACHINE VISION SYSTEMS
UV CURING SYSTEMS

Selection Guide
Fibers
Fiber Amplifiers

FX-500
FX-100
FX-300
FX-410
FX-311
FX-301-F7/
FX-301-F

SENSING CHARACTERISTICS (TYPICAL)

Reflective type Sensing field Sensing characteristics are listed in the alphabetic order of the Model No.

FD-32GX Reflective type

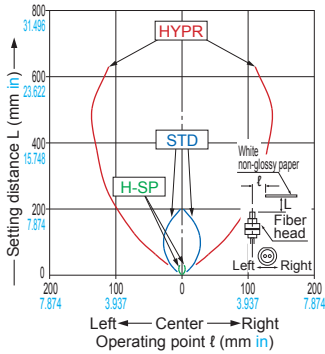

FD-40 Reflective type

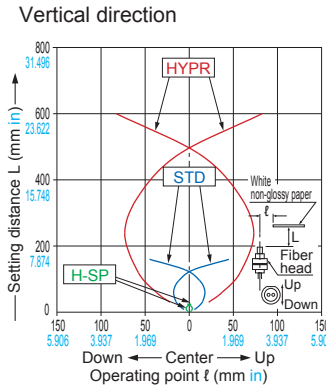
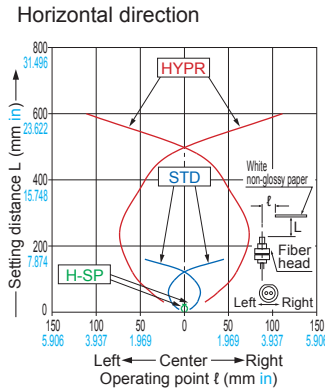

FD-41 Reflective type

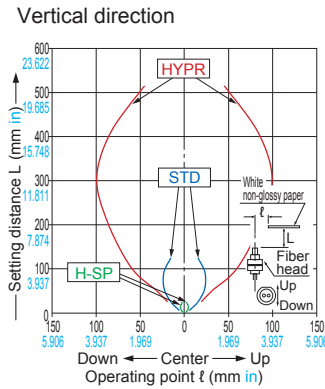
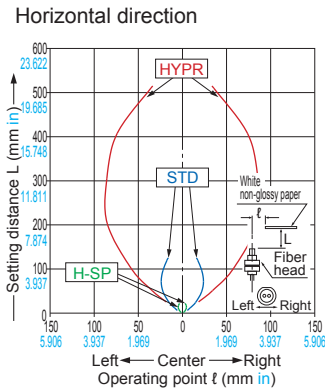

FD-41S Reflective type

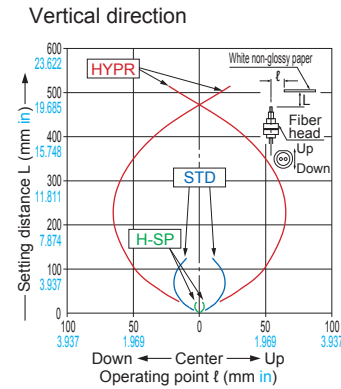
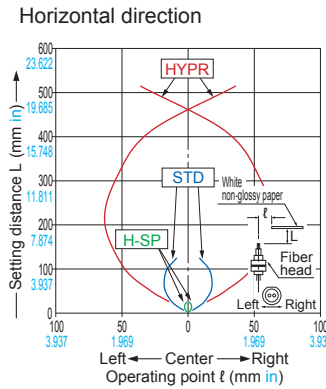

FD-41SW Reflective type

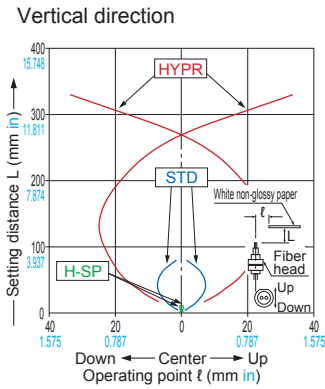
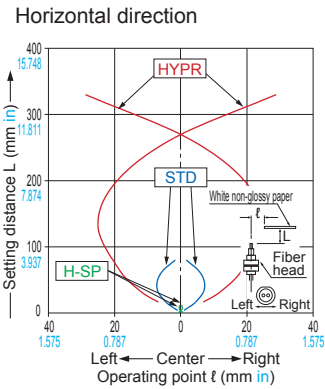

FD-41W Reflective type

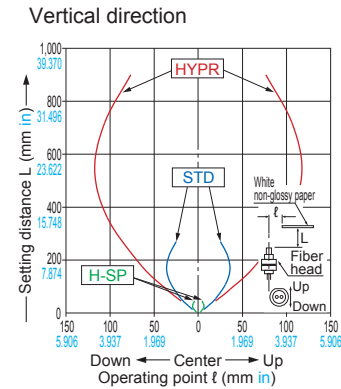
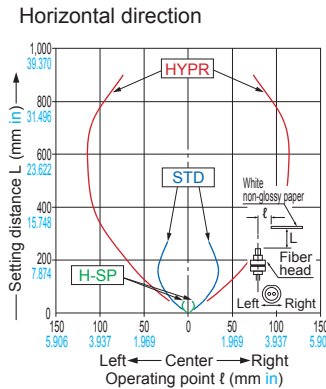

FD-42G Reflective type

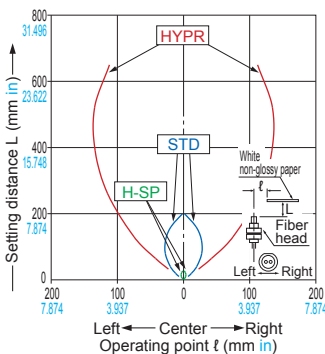

FD-42GW Reflective type

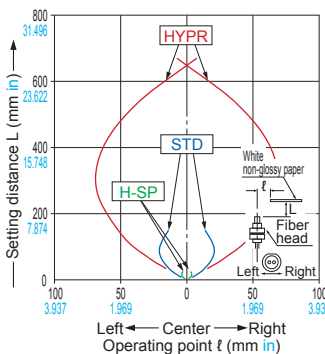

FD-60 Reflective type

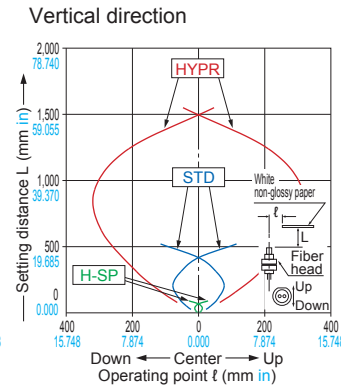
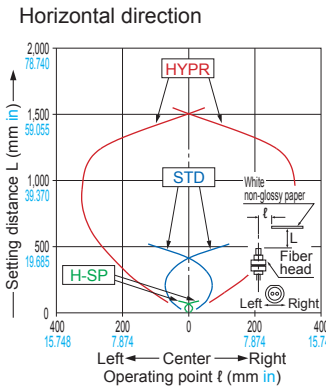

- FIBER SENSORS
- LASER SENSORS
- PHOTO-ELECTRIC SENSORS
- MICRO PHOTO-ELECTRIC SENSORS
- AREA SENSORS
- LIGHT CURTAINS / SAFETY COMPONENTS
- PRESSURE / FLOW SENSORS
- INDUCTIVE PROXIMITY SENSORS
- PARTICULAR USE SENSORS
- SENSOR OPTIONS
- SMILE WIRE-SAVING UNITS
- WIRE-SAVING SYSTEMS
- MEASUREMENT SENSORS
- STATIC ELECTRICITY PREVENTION DEVICES
- LASER MARKERS
- PLC
- HUMAN MACHINE INTERFACES
- ENERGY CONSUMPTION VISUALIZATION COMPONENTS
- FA COMPONENTS
- MACHINE VISION SYSTEMS
- UV CURING SYSTEMS
- Selection Guide
- Fibers
- Fiber Amplifiers
- FX-500**
- FX-100**
- FX-300**
- FX-410**
- FX-311**
- FX-301-F7/ FX-301-F**

SENSING CHARACTERISTICS (TYPICAL)

Reflective type Sensing field

Sensing characteristics are listed in the alphabetic order of the Model No.

FD-61 Reflective type

Horizontal direction

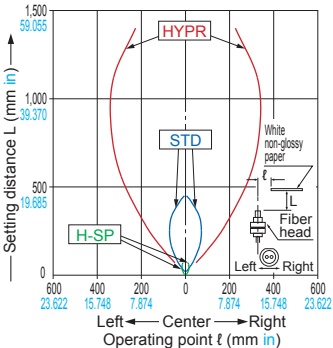

Vertical direction

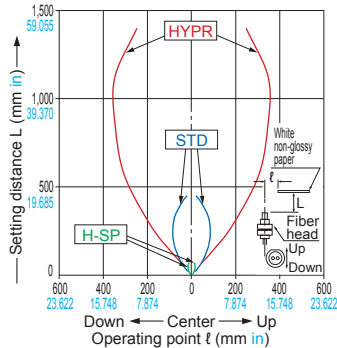

FD-61G Reflective type

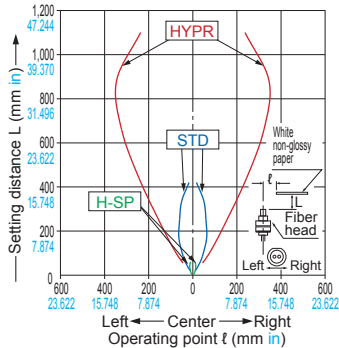

FD-61S Reflective type

Horizontal direction

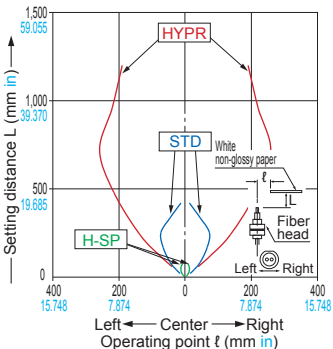

Vertical direction

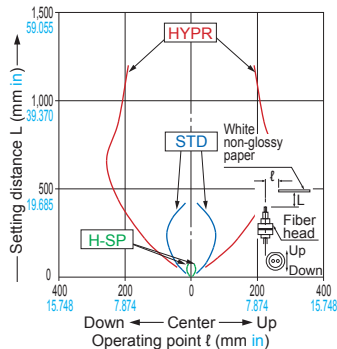

FD-61W Reflective type

Horizontal direction

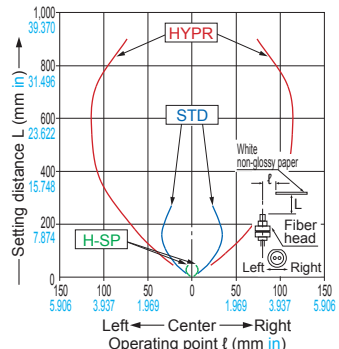

Vertical direction

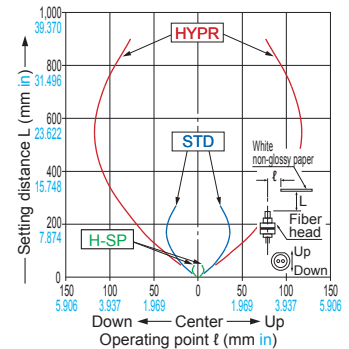

FD-62 Reflective type

Horizontal direction

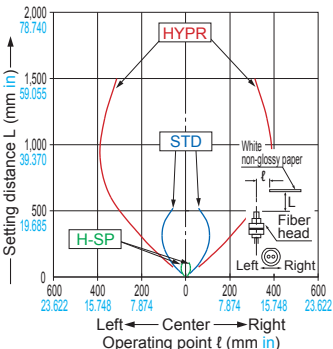

Vertical direction

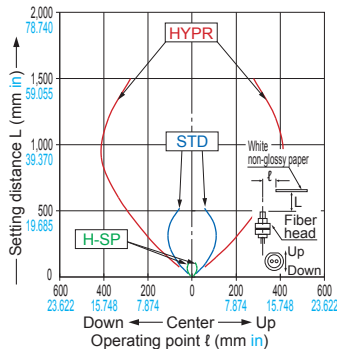

FD-64X Reflective type

Horizontal direction

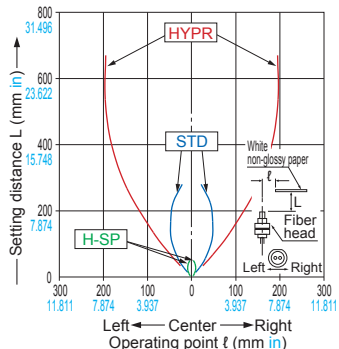

Vertical direction

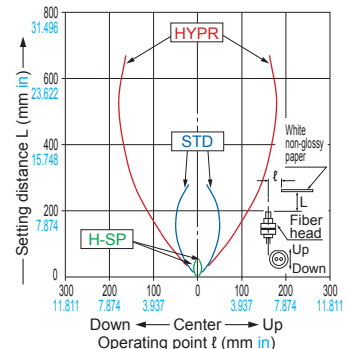

FX-500

FD-A16 Reflective type

Horizontal direction

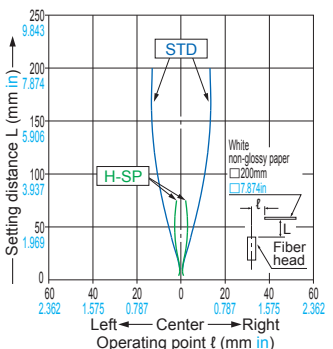

Vertical direction

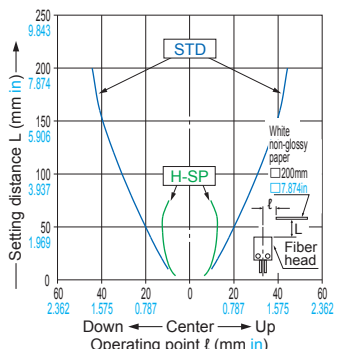

FD-AL11 Reflective type

Horizontal direction

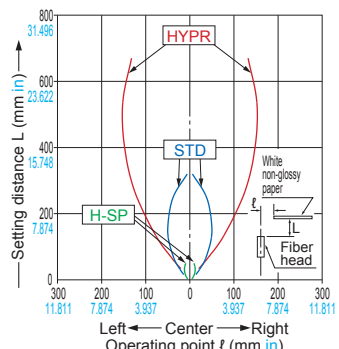

Vertical direction

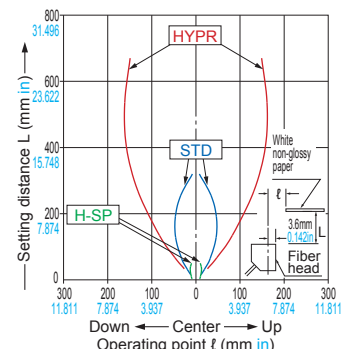

- LASER SENSORS
- PHOTO-ELECTRIC SENSORS
- MICRO PHOTO-ELECTRIC SENSORS
- AREA SENSORS
- LIGHT CURTAINS / SAFETY COMPONENTS
- PRESSURE / FLOW SENSORS
- INDUCTIVE PROXIMITY SENSORS
- PARTICULAR USE SENSORS
- SENSOR OPTIONS
- SIMPLE WIRE-SAVING UNITS
- WIRE-SAVING SYSTEMS
- MEASUREMENT SENSORS
- STATIC ELECTRICITY PREVENTION DEVICES
- LASER MARKERS
- PLC
- HUMAN MACHINE INTERFACES
- ENERGY CONSUMPTION VISUALIZATION COMPONENTS
- FA COMPONENTS
- MACHINE VISION SYSTEMS
- UV CURING SYSTEMS
- Selection Guide
- Fibers
- Fiber Amplifiers

SENSING CHARACTERISTICS (TYPICAL)

Reflective type Sensing field Sensing characteristics are listed in the alphabetic order of the Model No.

FD-E13

Reflective type

Horizontal direction

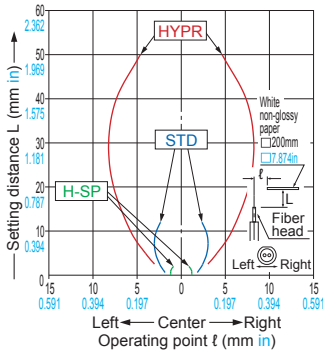

Vertical direction

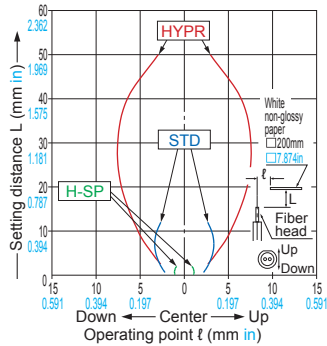

FD-E23

Reflective type

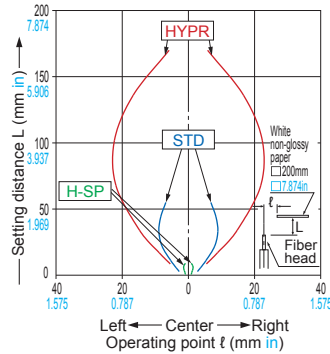

FD-EG30

Reflective type

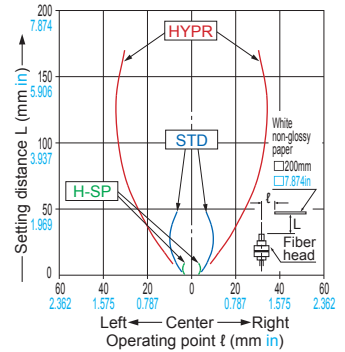

FD-EG30S

Reflective type

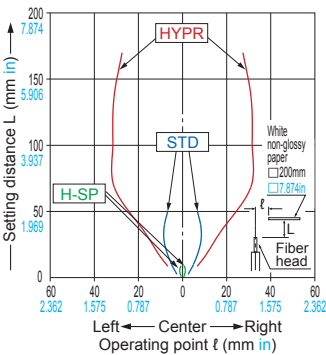

FD-EG31

Reflective type

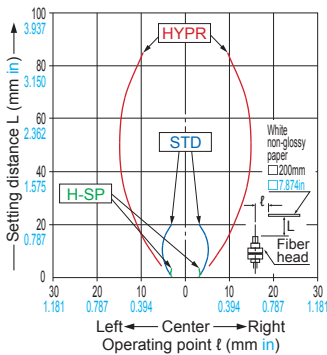

FD-H13-FM2

Reflective type

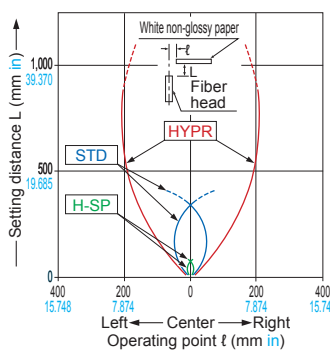

FD-H18-L31

Reflective type

Horizontal direction

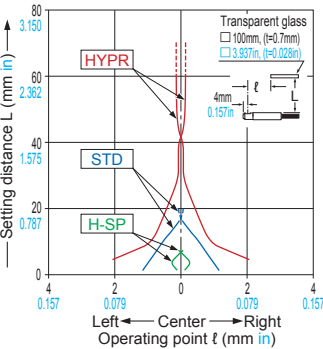

Vertical direction

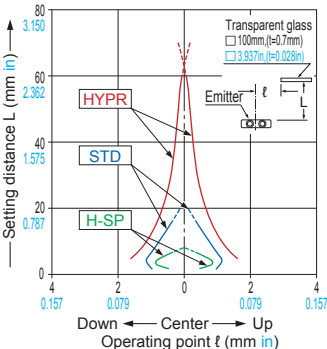

FD-H20-21

Reflective type

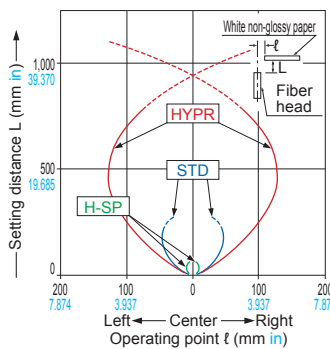

FD-H20-M1

Reflective type

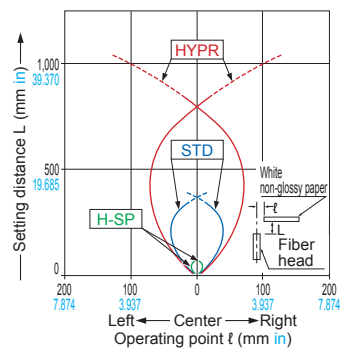

FD-H25-L43

Reflective type

Horizontal direction

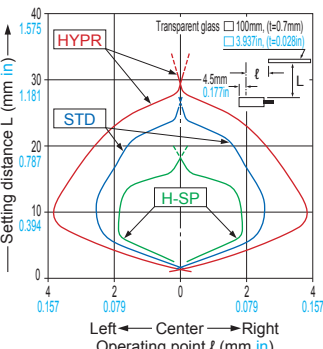

Vertical direction

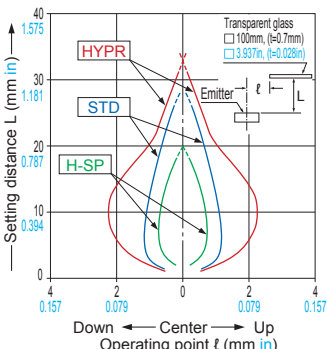

FIBER SENSORS

LASER SENSORS

PHOTO-ELECTRIC SENSORS

MICRO PHOTO-ELECTRIC SENSORS

AREA SENSORS

LIGHT CURTAINS / SAFETY COMPONENTS

PRESSURE / FLOW SENSORS

INDUCTIVE PROXIMITY SENSORS

PARTICULAR USE SENSORS

SENSOR OPTIONS

WIRE-SAVING UNITS

WIRE-SAVING SYSTEMS

MEASUREMENT SENSORS

STATIC ELECTRICITY PREVENTION DEVICES

LASER MARKERS

PLC

HUMAN MACHINE INTERFACES

ENERGY CONSUMPTION VISUALIZATION COMPONENTS

FA COMPONENTS

MACHINE VISION SYSTEMS

UV CURING SYSTEMS

Selection Guide

Fibers

Fiber Amplifiers

FX-500

FX-100

FX-300

FX-410

FX-311

FX-301-F7/ FX-301-F

SENSING CHARACTERISTICS (TYPICAL)

Reflective type Sensing field Sensing characteristics are listed in the alphabetic order of the Model No. (Models with same sensing characteristics are grouped together.)

FD-H25-L45 Reflective type

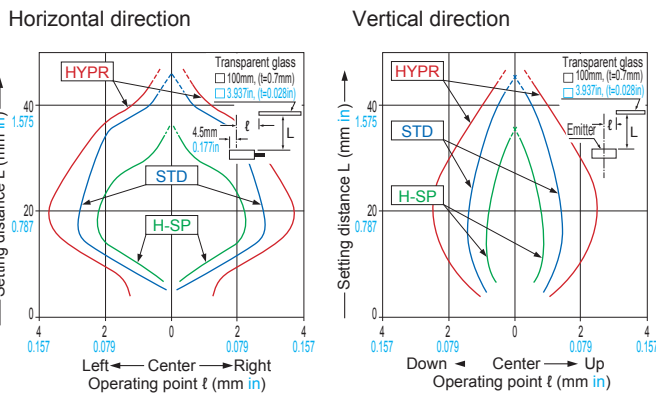

FD-H30-L32 Reflective type

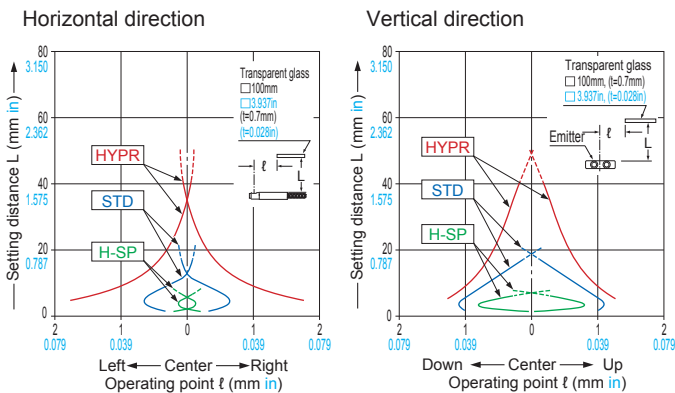

FD-H30-L32V-S Reflective type

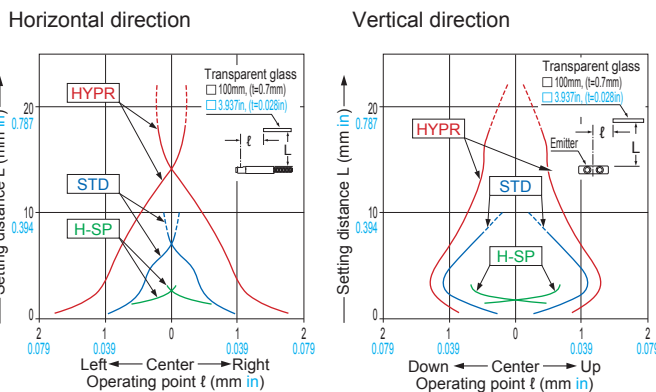

FD-H35-20S Reflective type

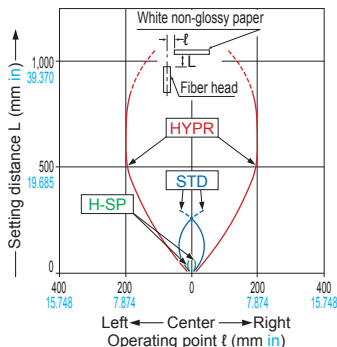

FD-H35-M2 Reflective type
FD-H35-M2S6

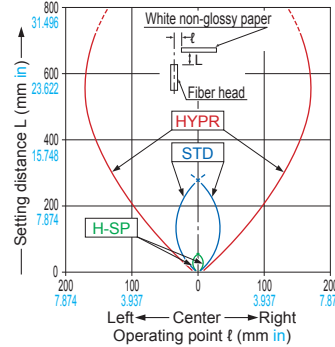

FD-L10 Reflective type

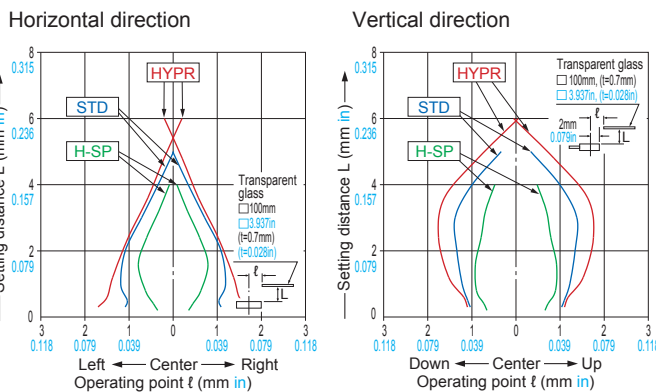

FD-L11 Reflective type

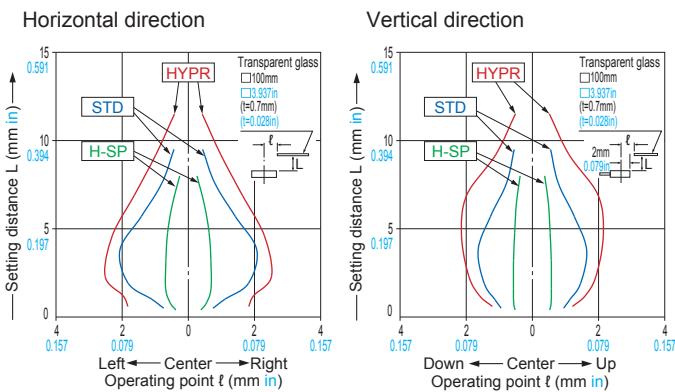

FD-L12W Reflective type

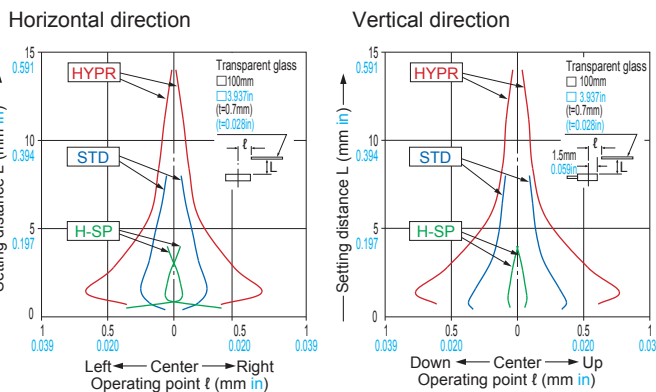

FD-L20H Reflective type

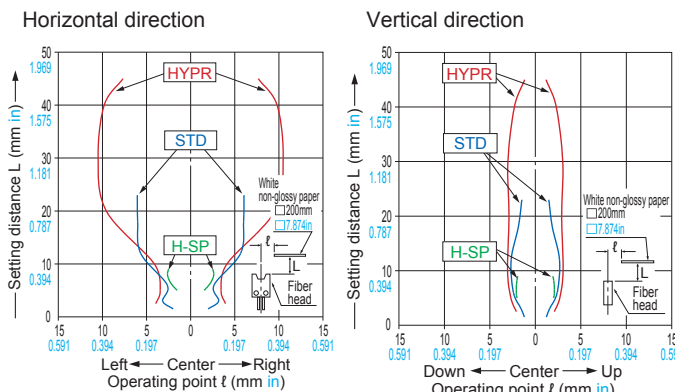

FIBER SENSORS
LASER SENSORS
PHOTO-ELECTRIC SENSORS
MICRO PHOTO-ELECTRIC SENSORS
AREA SENSORS
LIGHT CURTAINS / SAFETY COMPONENTS
PRESSURE / FLOW SENSORS
INDUCTIVE PROXIMITY SENSORS
PARTICULAR USE SENSORS
SENSOR OPTIONS

SIMPLE WIRE-SAVING UNITS
WIRE-SAVING SYSTEMS
MEASUREMENT SENSORS
STATIC ELECTRICITY PREVENTION DEVICES
LASER MARKERS
PLC
HUMAN MACHINE INTERFACES
ENERGY CONSUMPTION VISUALIZATION COMPONENTS
FA COMPONENTS
MACHINE VISION SYSTEMS

UV CURING SYSTEMS
Selection Guide
Fibers
Fiber Amplifiers

FX-500
FX-100
FX-300
FX-410
FX-311
FX-301-F7/
FX-301-F

SENSING CHARACTERISTICS (TYPICAL)

Reflective type Sensing field Sensing characteristics are listed in the alphabetic order of the Model No.

FD-L21

Reflective type

Horizontal direction

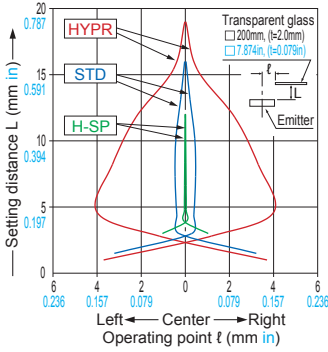

Vertical direction

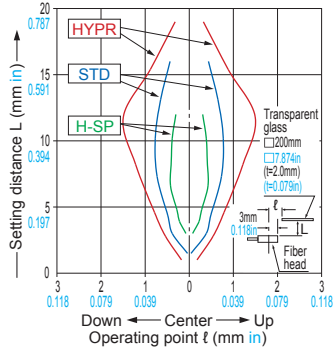

FD-L21W

Reflective type

Horizontal direction

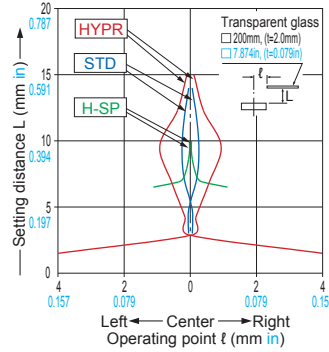

Vertical direction

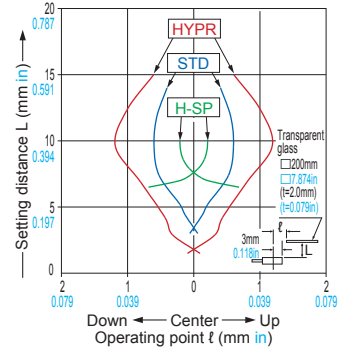

FD-L22A

Reflective type

Horizontal direction

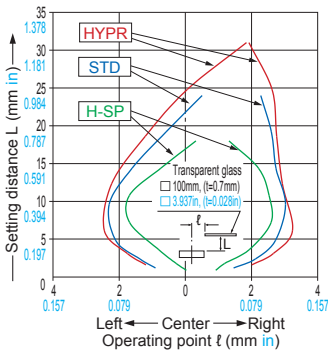

Vertical direction

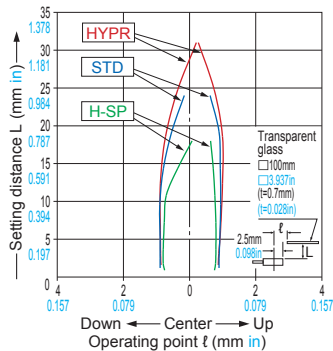

FD-L23

Reflective type

Horizontal direction

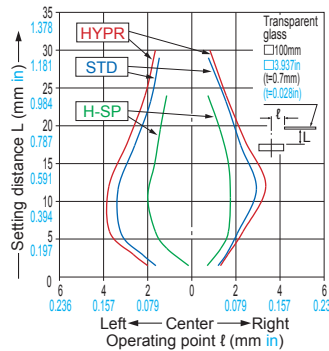

Vertical direction

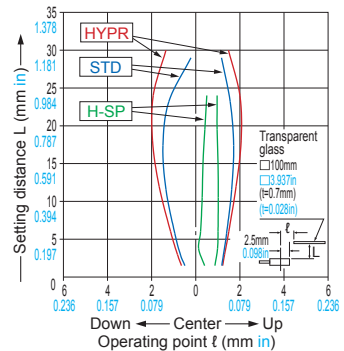

FD-L30A

Reflective type

Horizontal direction

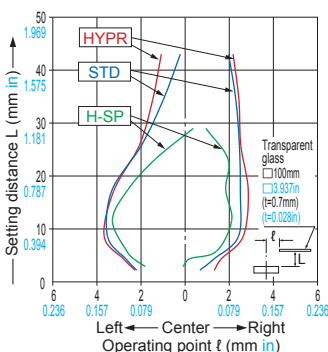

Vertical direction

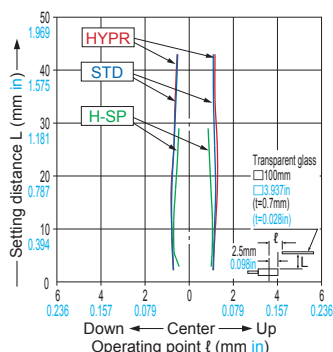

FD-L31A

Reflective type

Horizontal direction

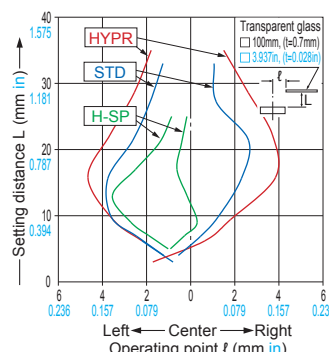

Vertical direction

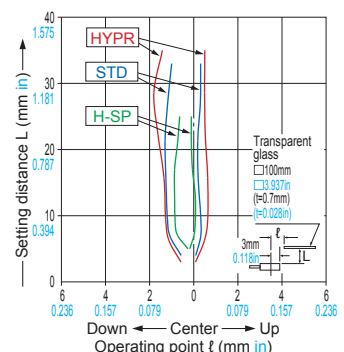

FD-L32H

Reflective type

Horizontal direction

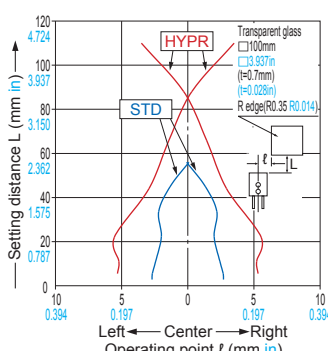

Vertical direction

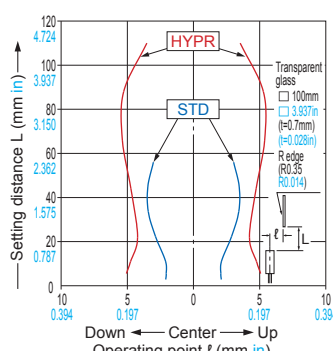

FD-R60

Reflective type

Horizontal direction

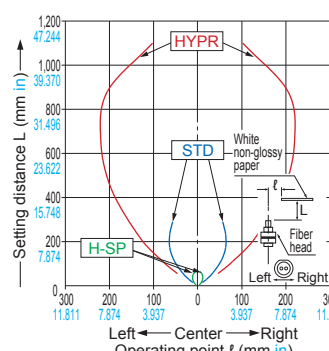

Vertical direction

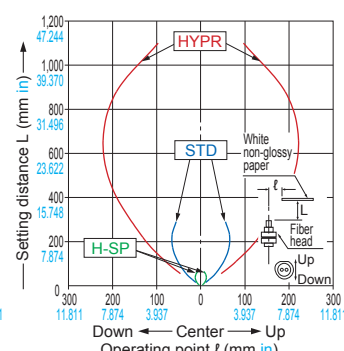

FIBER SENSORS

LASER SENSORS

PHOTO-ELECTRIC SENSORS

MICRO PHOTO-ELECTRIC SENSORS

AREA SENSORS

LIGHT CURTAINS / SAFETY COMPONENTS

PRESSURE / FLOW SENSORS

INDUCTIVE PROXIMITY SENSORS

PARTICULAR USE SENSORS

SENSOR OPTIONS

WIRE-SAVING UNITS

WIRE-SAVING SYSTEMS

MEASUREMENT SENSORS

STATIC ELECTRICITY PREVENTION DEVICES

LASER MARKERS

PLC

HUMAN MACHINE INTERFACES

ENERGY CONSUMPTION VISUALIZATION COMPONENTS

FA COMPONENTS

MACHINE VISION SYSTEMS

UV CURING SYSTEMS

Selection Guide

Fibers

Fiber Amplifiers

FX-500

FX-100

FX-300

FX-410

FX-311

FX-301-F7 / FX-301-F

SENSING CHARACTERISTICS (TYPICAL)

Reflective type Sensing field Sensing characteristics are listed in the alphabetic order of the Model No.

FD-R61Y Reflective type

Horizontal direction

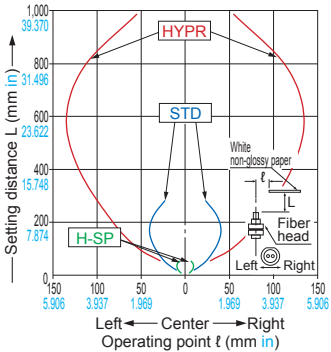

Vertical direction

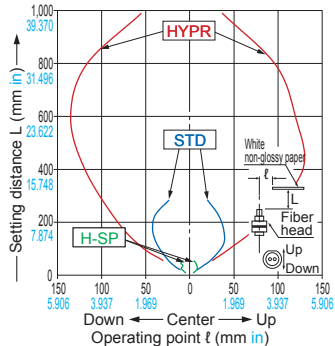

FD-S21 Reflective type

Horizontal direction

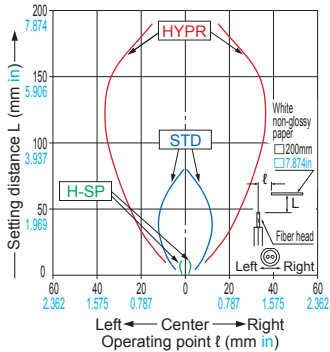

Vertical direction

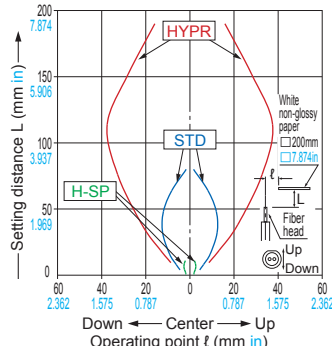

FD-S30 Reflective type

Horizontal direction

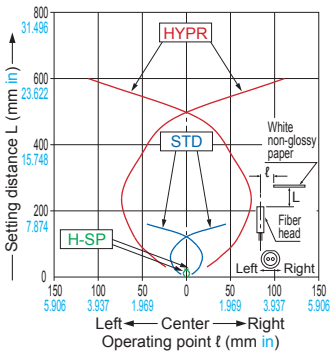

Vertical direction

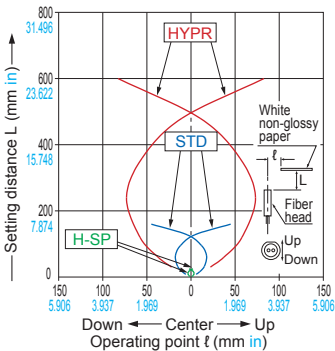

FD-S31 Reflective type

Horizontal direction

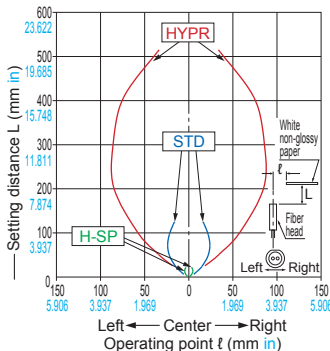

Vertical direction

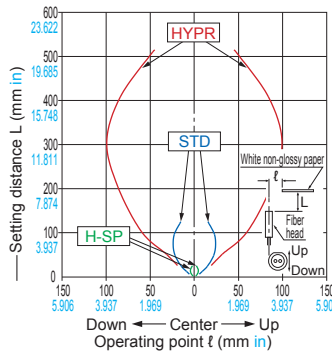

FD-S32 Reflective type

Horizontal direction

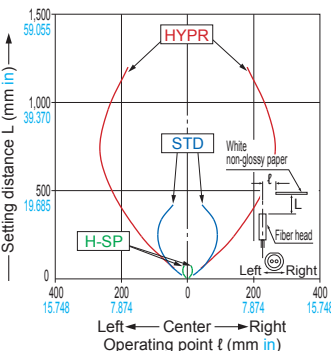

Vertical direction

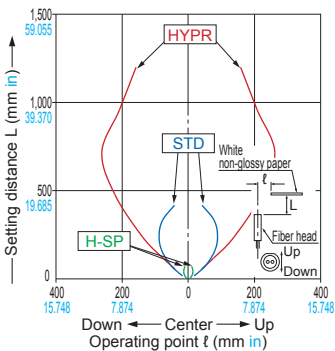

FD-S32W Reflective type

Horizontal direction

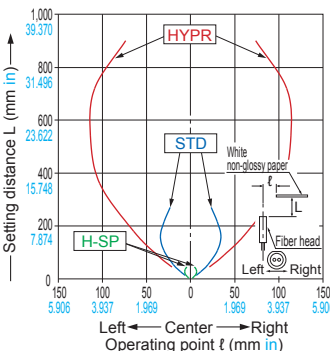

Vertical direction

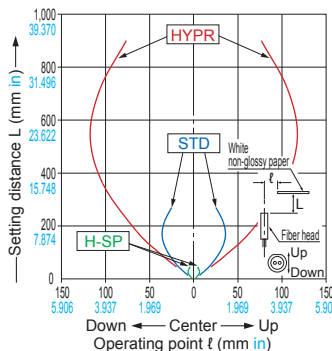

FX-500

FX-100

FX-300

FX-410

FX-311

FX-301-F7/

FX-301-F

FD-S33GW Reflective type

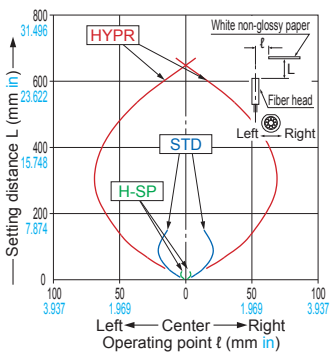

FD-S60Y Reflective type

Horizontal direction

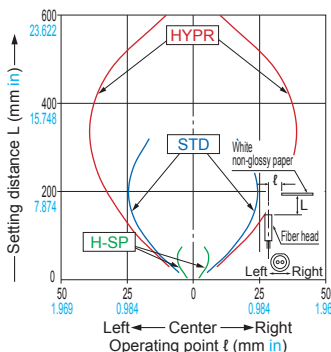

Vertical direction

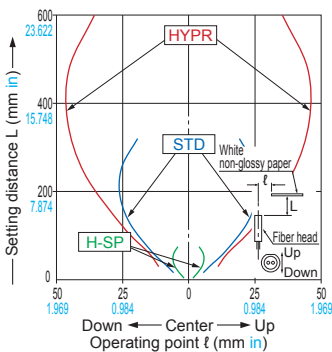

SENSING CHARACTERISTICS (TYPICAL)

Reflective type Sensing field Sensing characteristics are listed in the alphabetic order of the Model No.

FD-V30

Reflective type

Horizontal direction

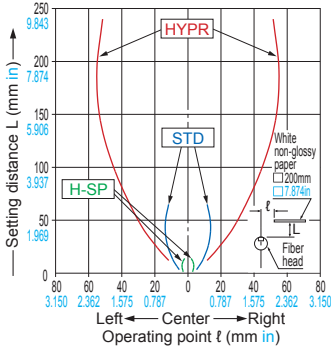

Vertical direction

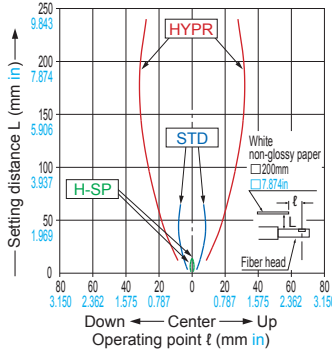

FD-V30W

Reflective type

Horizontal direction

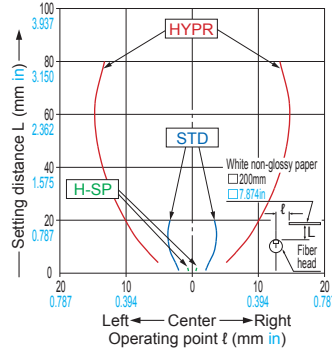

Vertical direction

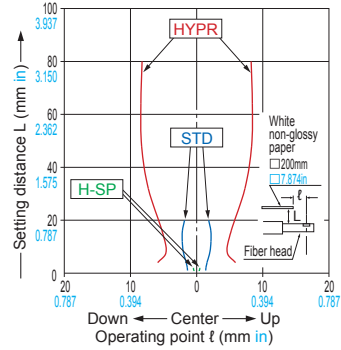

FD-V50

Reflective type

Horizontal direction

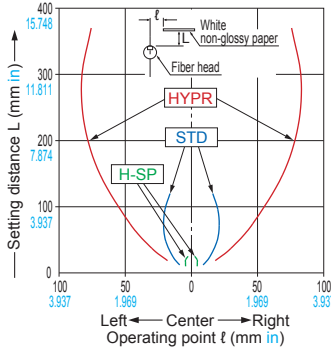

Vertical direction

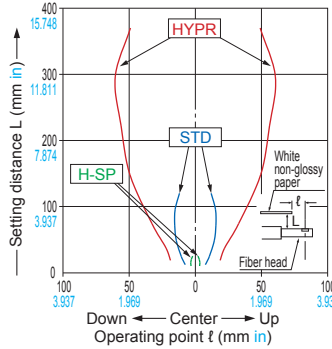

FD-Z20HBW

Reflective type

Horizontal direction

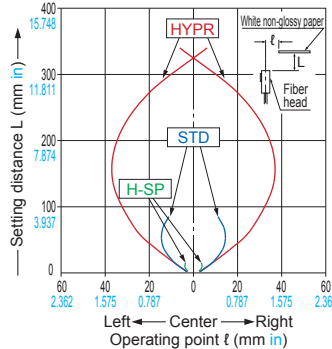

Vertical direction

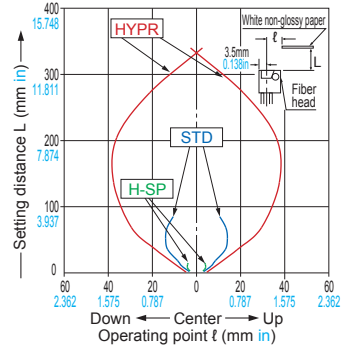

FD-Z20W

Reflective type

Horizontal direction

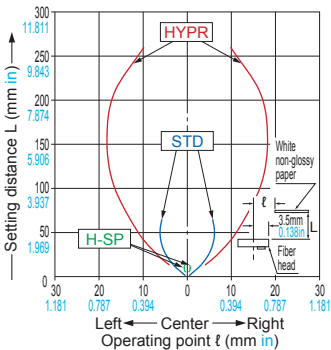

Vertical direction

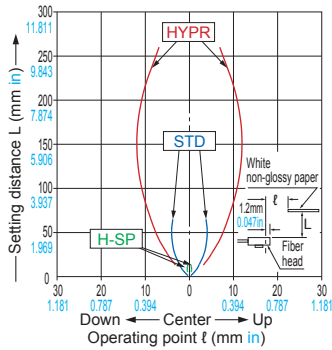

FD-Z40HBW

Reflective type

Horizontal direction

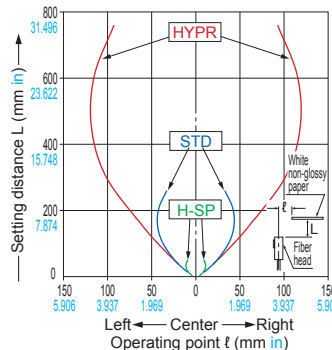

Vertical direction

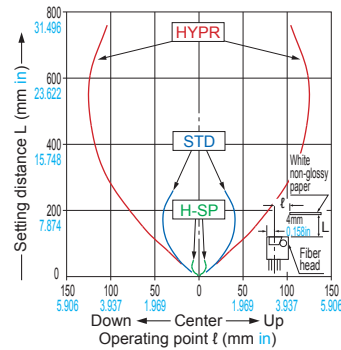

FD-Z40W

Reflective type

Horizontal direction

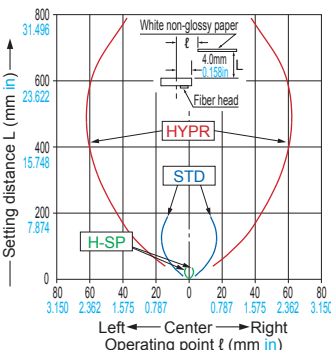

Vertical direction

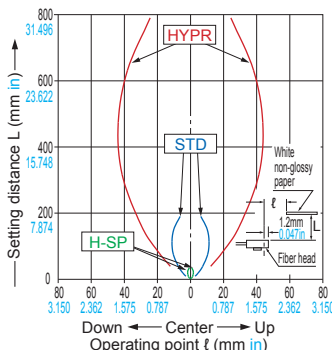

FD-Z50HW

Reflective type

Horizontal direction

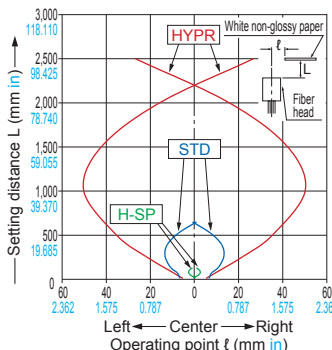

Vertical direction

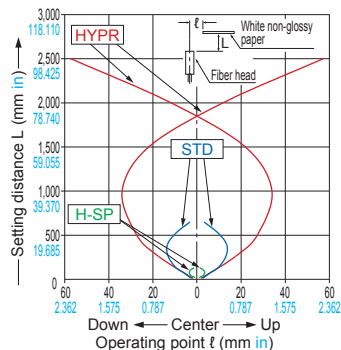

FIBER SENSORS

LASER SENSORS

PHOTO-ELECTRIC SENSORS

MICRO PHOTO-ELECTRIC SENSORS

AREA SENSORS

LIGHT CURTAINS / SAFETY COMPONENTS

PRESSURE / FLOW SENSORS

INDUCTIVE PROXIMITY SENSORS

PARTICULAR USE SENSORS

SENSOR OPTIONS

SIMPLE WIRE-SAVING UNITS

WIRE-SAVING SYSTEMS

MEASUREMENT SENSORS

STATIC ELECTRICITY PREVENTION DEVICES

LASER MARKERS

PLC

HUMAN MACHINE INTERFACES

ENERGY CONSUMPTION VISUALIZATION COMPONENTS

FA COMPONENTS

MACHINE VISION SYSTEMS

UV CURING SYSTEMS

Selection Guide

Fibers

Fiber Amplifiers

FX-500

FX-100

FX-300

FX-410

FX-311

FX-301-F7/ FX-301-F

PRECAUTIONS FOR PROPER USE

Refer to the "PRO mode operation manual" on our website for details.



- Never use this product as a sensing device for personnel protection.
- In case of using sensing devices for personnel protection, use products which meet laws and standards, such as OSHA, ANSI or IEC etc., for personnel protection applicable in each region or country.

Wiring

- Make sure that the power supply is OFF while adding or removing the amplifiers.
- Note that if a voltage exceeding the rated range is applied, or if an AC power supply is directly connected, the product may get burnt or damaged.
- Note that short-circuit of the load or wrong wiring may burn or damage the product.
- Do not run the wires together with high-voltage lines or power lines, or put them in the same raceway. This can cause malfunction due to induction.
- Verify that the supply voltage variation is within the rating.
- If power is supplied from a commercial switching regulator, ensure that the frame ground (F.G.) terminal of the power supply is connected to an actual ground.
- In case noise generating equipment (switching regulator, inverter motor, etc.) is used in the vicinity of this product, connect the frame ground (F.G.) terminal of the equipment to an actual ground.
- Make sure to use the quick-connection cable (optional) for the connection of the controller. Extension up to total 100 m **328.084 ft** is possible with 0.3 mm² or more, cable. However, in order to reduce noise, make the wiring as short as possible.
- Make sure that stress by forcible bending or pulling is not applied to the sensor cable joint and fiber cable.

Others

- Our products have been developed / produced for industrial use only.
- The specification may not be satisfied in a strong magnetic field.
- The ultra long distance (U-LG, HYPR) mode is more likely to be affected by extraneous noise since the sensitivity of that is higher than the other modes. Make sure to check the environment before use.
- Do not use during the initial transient time (H-SP, FAST, STD: 0.5 sec., LONG, U-LG, HYPR: 1 sec.) after the power supply is switched ON.
- These sensors are only for indoor use.
- Avoid dust, dirt, and steam.
- Make sure that the product does not come in contact with oil, grease, organic solvents such as thinner, etc., strong acid or alkaline.
- This product cannot be used in an environment containing inflammable or explosive gases.
- Never disassemble or modify this product.
- This product adopts EEPROM. Settings cannot be done a million times or more because of the EEPROM's lifetime.

FIBER SENSORS

LASER SENSORS

PHOTO-ELECTRIC SENSORS

MICRO PHOTO-ELECTRIC SENSORS

AREA SENSORS

LIGHT CURTAINS / SAFETY COMPONENTS

PRESSURE / FLOW SENSORS

INDUCTIVE PROXIMITY SENSORS

PARTICULAR USE SENSORS

SENSOR OPTIONS

SIMPLE WIRE-SAVING UNITS

WIRE-SAVING SYSTEMS

MEASUREMENT SENSORS

STATIC ELECTRICITY PREVENTION DEVICES

LASER MARKERS

PLC

HUMAN MACHINE INTERFACES

ENERGY CONSUMPTION VISUALIZATION COMPONENTS

FA COMPONENTS

MACHINE VISION SYSTEMS

UV CURING SYSTEMS

Selection Guide

Fibers

Fiber Amplifiers

FX-500

FX-100

FX-300

FX-410

FX-311

FX-301-F7/
FX-301-F

DIMENSIONS (Unit: mm in)

The CAD data in the dimensions can be downloaded from our website.

FX-501(P) FX-502(P) Amplifier

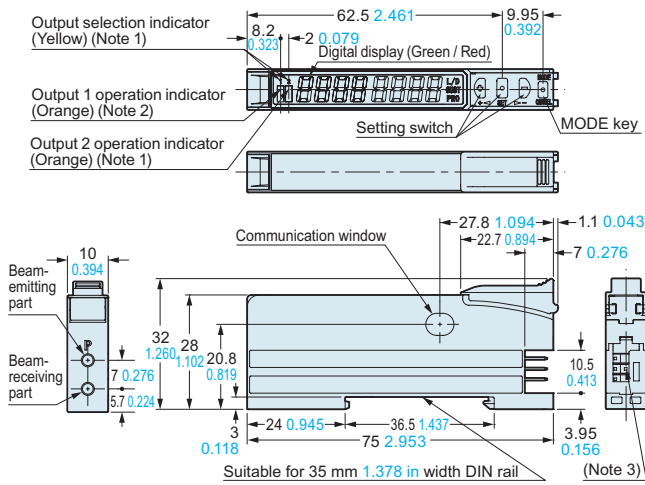

- Notes: 1) FX-502(P) only
- 2) FX-501(P): Operation indicator
- 3) FX-501(P): 3-pin, FX-502(P): 4-pin

FX-505-C2 FX-505P-C2 Amplifier

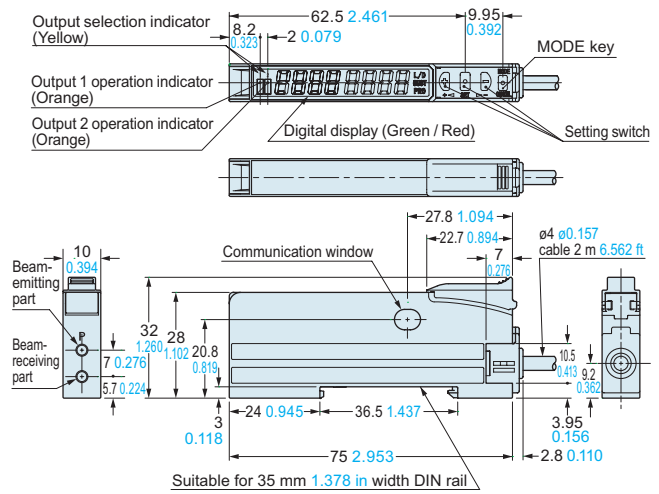

CN-73-C□ CN-74-C□ Main cable (Optional)

• Length L

Model No.	Length L
CN-73/74-C1	1,000 39.370
CN-73/74-C2	2,000 78.740
CN-73/74-C5	5,000 196.850

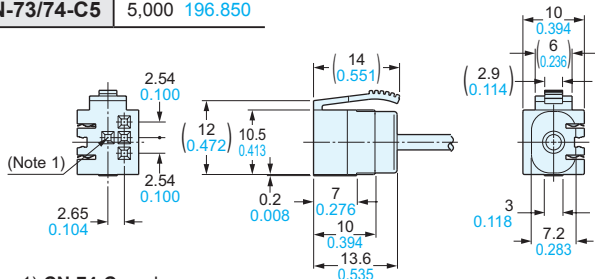
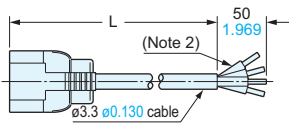

- Notes: 1) CN-74-C□ only
- 2) CN-73-C□: 3-core

CN-71-C□ CN-72-C□ Sub cable (Optional)

• Length L

Model No.	Length L
CN-71/72-C1	1,000 39.370
CN-71/72-C2	2,000 78.740
CN-71/72-C5	5,000 196.850

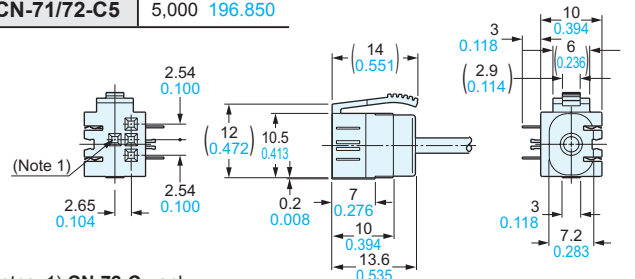
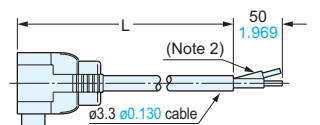

- Notes: 1) CN-72-C□ only
- 2) CN-71-C□: 1-core

MS-DIN-2 Amplifier mounting bracket (Optional)

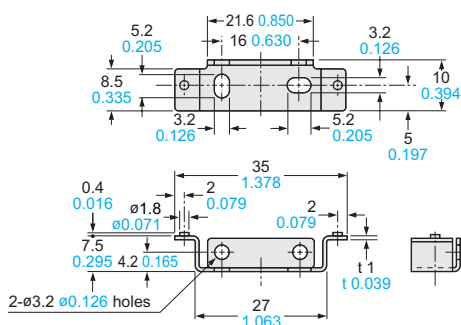

Material: Cold rolled carbon steel (SPCC)
(Uni-chrome plated)

MS-DIN-E End plate (Optional)

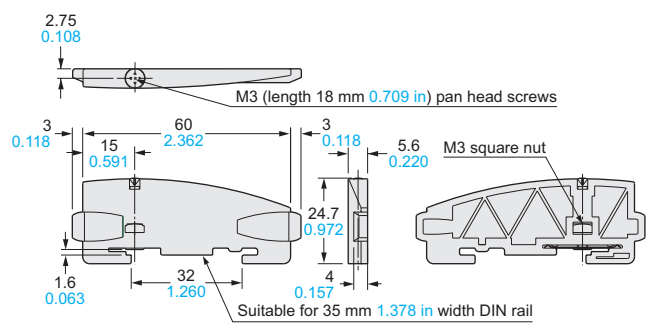

Material: Polycarbonate

FIBER SENSORS

LASER SENSORS

PHOTO-ELECTRIC SENSORS

MICRO PHOTO-ELECTRIC SENSORS

AREA SENSORS

LIGHT CURTAINS / SAFETY COMPONENTS

PRESSURE / FLOW SENSORS

INDUCTIVE PROXIMITY SENSORS

PARTICULAR USE SENSORS

SENSOR OPTIONS

SIMPLE WIRE-SAVING UNITS

WIRE-SAVING SYSTEMS

MEASUREMENT SENSORS

STATIC ELECTRICITY PREVENTION DEVICES

LASER MARKERS

PLC

HUMAN MACHINE INTERFACES

ENERGY CONSUMPTION VISUALIZATION COMPONENTS

FA COMPONENTS

MACHINE VISION SYSTEMS

UV CURING SYSTEMS

Selection Guide

Fibers

Fiber Amplifiers

FX-500

FX-100

FX-300

FX-410

FX-311

FX-301-F7/ FX-301-F