

Evaluating the **ADP5070/ADP5071** DC-to-DC Switching Regulators/Converters

FEATURES

Input voltage range: 3 V to 5.5 V

Output voltage: ± 15 V

Output voltage with low dropout (LDO) regulators: ± 12 V

EVALUATION KIT CONTENTS

ADP5070CP-EVALZ or **ADP5071CP-EVALZ** evaluation board

ADDITIONAL EQUIPMENT NEEDED

DC power supply

Multimeters for voltage and current measurements

Electronic or resistive loads

GENERAL DESCRIPTION

The **ADP5070CP-EVALZ** and **ADP5071CP-EVALZ** evaluation boards demonstrate the functionality of the **ADP5070** and **ADP5071** dc-to-dc converters, respectively.

Use either board to evaluate simple device measurements, such as line regulation, load regulation, and efficiency. Device features can be demonstrated, such as selectable operating frequency, soft start, sequencing, and slew rate control. The **ADP7142** and **ADP7182** LDO regulators are also available on the boards as an option for enhanced low noise output.

For more details about the dc-to-dc converters, refer to the **ADP5070** and **ADP5071** data sheets. For further information on the LDO regulators, refer to the **ADP7142** and **ADP7182** data sheets.

PICTURE OF EVALUATION BOARD

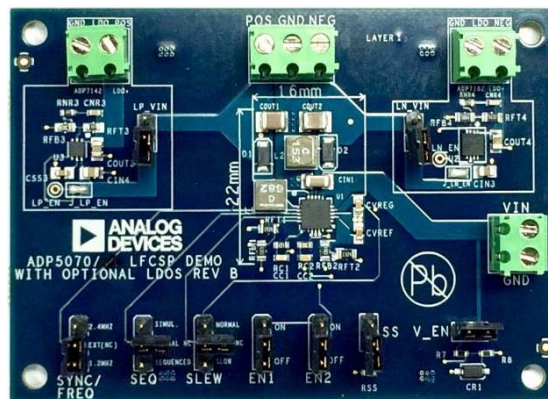

Figure 1. **ADP5070CP-EVALZ/ADP5071CP-EVALZ** LFCSP Evaluation Board

TABLE OF CONTENTS

Features	1	Output Voltage Measurements	6
Evaluation Kit Contents.....	1	Line Regulation.....	6
Additional Equipment Needed	1	Load Regulation	7
General Description	1	Efficiency	7
Picture of Evaluation Board	1	Evaluation Board Schematics.....	8
Revision History	2	Ordering Information.....	10
Evaluation Board Hardware.....	3	Bill of Materials.....	10
Evaluation Board Configurations	3		

REVISION HISTORY

3/15—Revision 0: Initial Version

EVALUATION BOARD HARDWARE

EVALUATION BOARD CONFIGURATIONS

The evaluation boards are configured to provide a ±15 V output from a 3 V to 5.5 V input. The optional LDO regulators are configured for a 12 V output (ADP7142) and a -12 V output (ADP7182).

Table 2 and Table 3 list the components for the ADP5070 and ADP5071 boards, respectively.

Table 4 lists the components common to both designs, including the ADP7142 and ADP7182 LDO regulators.

The boards allow the end user to customize the design; refer to the ADP5070 and ADP5071 data sheets or to the ADIsimPower tools to obtain alternative component values. If the design is customized, it is possible to obtain more than 70 V between the positive and negative terminals on the boards. It is the responsibility of the end user to ensure the boards are suitable for such a design and to take appropriate safety precautions.

Figure 2 outlines the board features available to the user. Figure 3 and Figure 4 highlight the ADP5070/ADP5071 and supporting components, including locations for optional components if the user wants to modify the design.

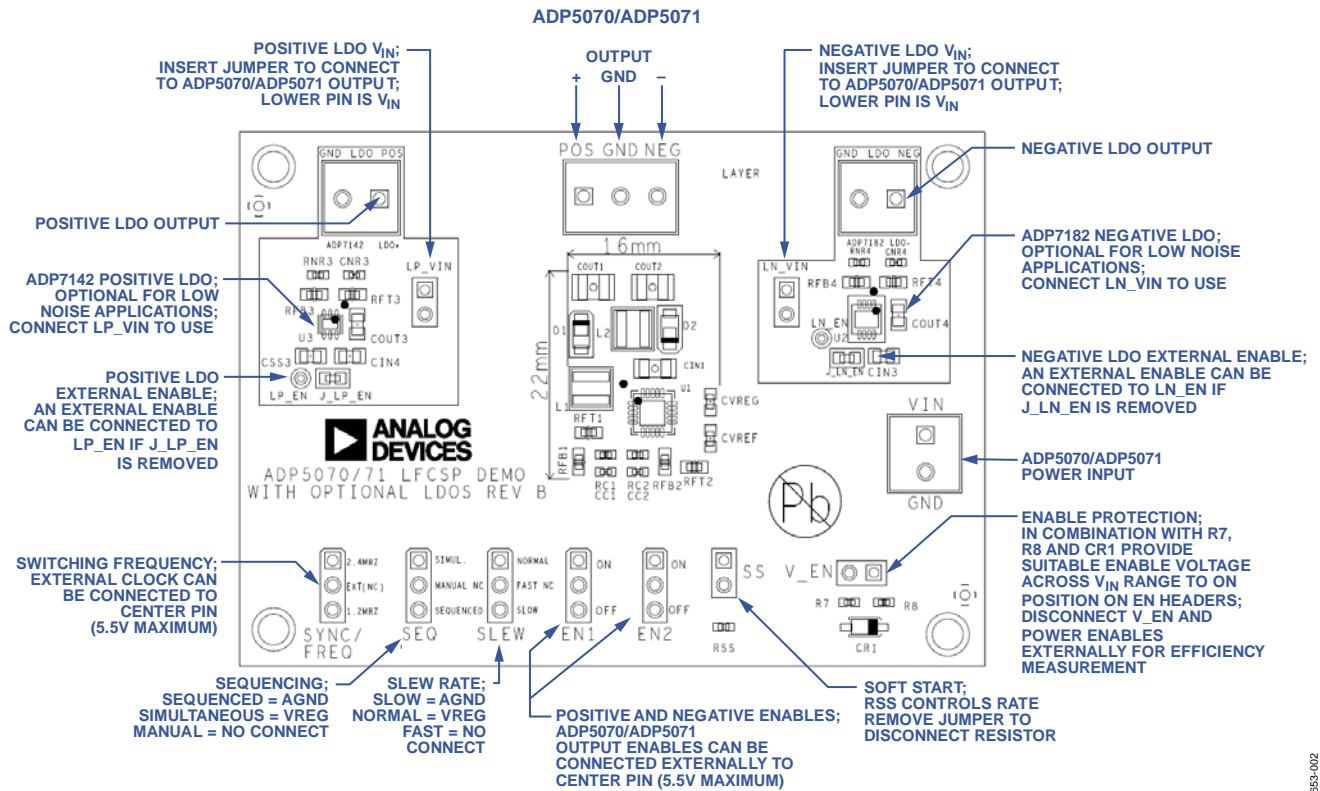

Figure 2. Outline of ADP5070/ADP5071 Evaluation Board Features

12653-002

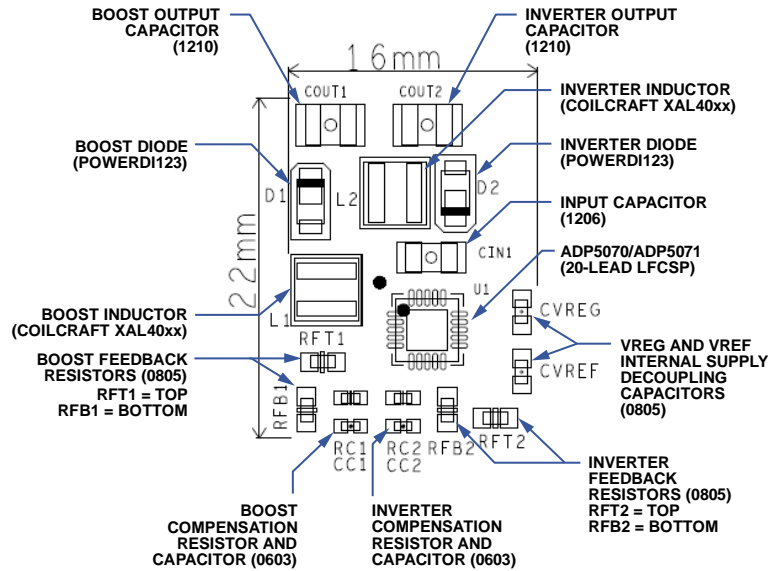

Figure 3. ADP5070/ADP5071 Top Component Detail

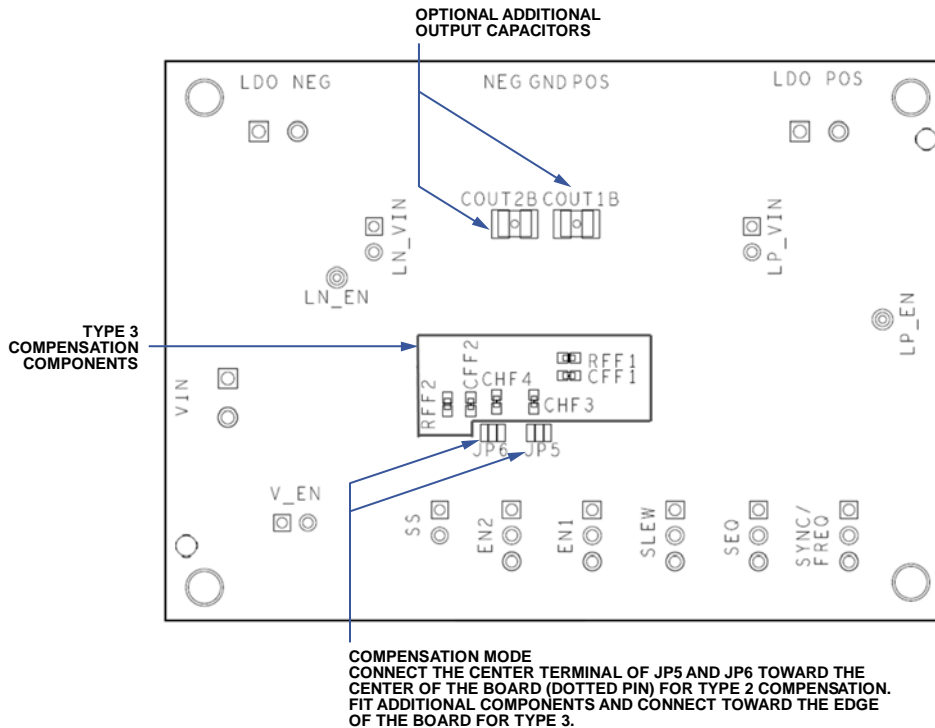

Figure 4. Bottom of Evaluation Printed Circuit Board (PCB) Showing Locations for Optional Components

Table 1. Evaluation Board Function Descriptions

Jumper/Connector Mnemonic	Description
VIN	Power supply to the ADP5070/ADP5071 . In the default configuration, this ranges from 3 V to 5.5 V.
POS	Output from boost regulator of the ADP5070/ADP5071 . 15 V in default configuration.
NEG	Output from inverting regulator of the ADP5070/ADP5071 . –15 V in default configuration.
V_EN	Provides a clamped enable voltage to allow the boards to operate using input voltages greater than 5.5 V without damaging the EN1 and EN2 pins. For efficiency measurements, remove this jumper and provide an enable signal from an external supply.
EN1	Boost regulator precision enable. The EN1 pin is compared to an internal precision reference to enable the boost regulator output. Connect this jumper to the on position to turn on the boost regulator. Connect this jumper to the off position or remove this jumper to turn the regulator off (an internal pulldown is present in the ADP5070/ADP5071). Connect an external enable voltage below the lesser of 5.5 V and V_{IN} to the center pin during efficiency measurement and remove the V_EN jumper.
EN2	Inverting regulator precision enable. The EN2 pin is compared to an internal precision reference to enable the inverting regulator output. Connect this jumper to the on position to turn on the inverting regulator. Connect this jumper to the off position or remove this jumper to turn the regulator off (an internal pulldown is present in the ADP5070/ADP5071). Connect an external enable voltage below the lesser of 5.5 V and V_{IN} to the center pin during efficiency measurement and remove the V_EN jumper.
SYNC/FREQ	Synchronization input and frequency setting. To set the switching frequency to 2.4 MHz, pull the SYNC/FREQ pin high. To set the switching frequency to 1.2 MHz, pull the SYNC/FREQ pin low. To synchronize the switching frequency, connect the SYNC/FREQ pin to an external clock (5.5 V maximum).
SEQ	Start-up sequence control. For manual V_{POS}/V_{NEG} startup using an individual precision enabling pin, leave the SEQ pin open. For simultaneous V_{POS}/V_{NEG} startup when the EN2 pin rises, connect the SEQ pin to VREG (use the EN1 pin to enable internal references early, if required). For a sequenced startup, pull the SEQ pin low. Use either EN1 or EN2 to enable V_{POS} or V_{NEG} and the corresponding supply is the first in sequence; hold the other enable pin low.
SLEW	Driver stage slew rate control. The SLEW pin sets the slew rate for the SW1 and SW2 drivers. For the fastest slew rate (best efficiency), leave the SLEW pin open. For a normal slew rate, connect the SLEW pin to VREG. For the slowest slew rate (best noise performance), connect the SLEW pin to AGND.
SS	Soft start programming. Leave the SS pin open to obtain the fastest soft start time. To program a slower soft start time, connect this jumper. This jumper connects the RSS resistor between the SS pin and AGND.
LDO POS	Positive output of the ADP7142 LDO regulator. Connect LP_VIN to use the external positive LDO regulator. Set to 12 V in the default configuration.
LP_VIN	Connects the positive output of the ADP5070/ADP5071 to the ADP7142 LDO regulator.
LP_EN	Use as an external enable for the ADP7142 LDO regulator if J_LP_EN is removed.
LDO NEG	Negative output of the ADP7182 LDO regulator. Connect LN_VIN to use the external negative LDO regulator. Set to –12 V in the default configuration.
LN_VIN	Connects the negative output of the ADP5070/ADP5071 to the ADP7182 LDO regulator.
LN_EN	Use as an external enable for the ADP7182 LDO regulator if J_LN_EN is removed.

OUTPUT VOLTAGE MEASUREMENTS

For basic output voltage accuracy measurements, connect the evaluation boards to a voltage source and a voltmeter. Use a resistor as the load for the regulator.

Ensure that the resistor has an adequate power rating to handle the expected power dissipation. Use an electronic load as an alternative. Ensure that the voltage source supplies enough current for the expected load levels, taking into account the device efficiency.

Follow these steps to connect to a voltage source and voltmeter:

1. Connect the negative (–) terminal of the voltage source to the GND terminal of the power input connector on the right side of the evaluation boards.
2. Connect the positive (+) terminal of the voltage source to the VIN terminal of the power input connector on the right side of the evaluation boards.
3. Connect a load between the POS or NEG terminal and GND terminal at the output connector (center top of the PCB).
4. Connect the voltmeter across the selected output terminal and ground in parallel with the load resistor.

Turn the voltage source on. If the EN1 or EN2 jumper is in the on position, the respective boost or inverting regulator powers up. Disconnect the SEQ jumper.

If the load current is large, the user must connect the voltmeter as close as possible to the output capacitor to reduce the effects of voltage drops due to PCB trace impedance.

If long power leads are used from the power supply, especially at higher loads, connect a large capacitor (10,000 μF or more) across the VIN terminals to prevent losses from lead inductance. Measure the input voltage at these terminals or use a power supply with a 4-wire supply and sense arrangement.

LINE REGULATION

For line regulation measurements, monitor the regulator output while its input is varied. For good line regulation, the output must change as little as possible with varying input levels. It is possible to repeat this measurement under different load conditions. During line regulation tests, keep the power supply leads short and remove any additional input capacitor. Figure 5 and Figure 6 show the typical line regulation performance of the [ADP5070/ADP5071](#) at both the output and feedback pins.

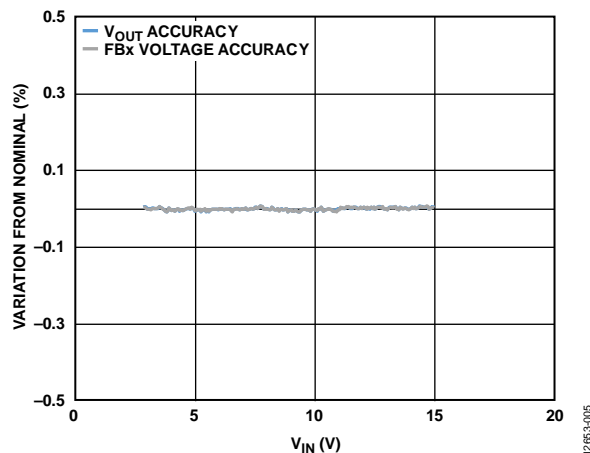

Figure 5. Boost Regulator Line Regulation, $V_{POS} = 15\text{ V}$, $f_{SW} = 1.2\text{ MHz}$, 15 mA Load, $T_A = 25^\circ\text{C}$ (Nominal Defined as Average Value Within a Range of 10% to 90% V_{IN})

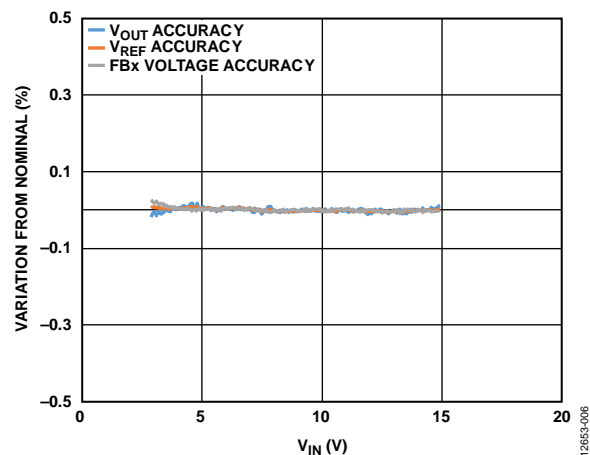

Figure 6. Inverting Regulator Line Regulation, $V_{NEG} = -15\text{ V}$, $f_{SW} = 1.2\text{ MHz}$, 15 mA Load, $T_A = 25^\circ\text{C}$ (Nominal Defined as Average Value Within a Range of 10% to 90% V_{IN})

LOAD REGULATION

For load regulation measurements, monitor the regulator output while the load is varied. For good load regulation, the output must change as little as possible with varying loads. The input voltage must be held constant during this measurement. Figure 7 and Figure 8 show the typical load regulation performance of the ADP5070/ADP5071 at both the output and feedback pins. Keep power leads short during this test and use a power supply with remote sense.

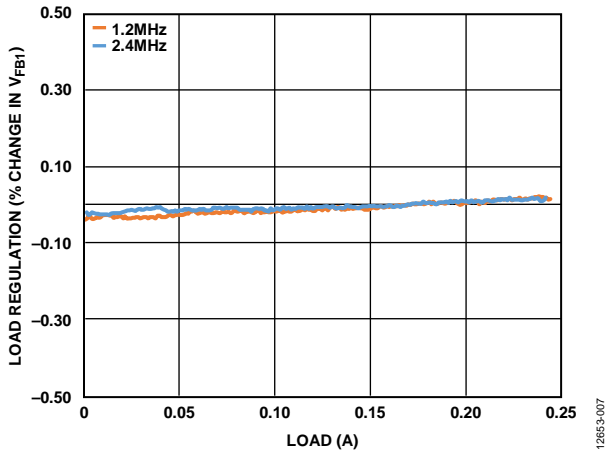

Figure 7. Boost Regulator Load Regulation, $V_{IN} = 5\text{ V}$, $V_{POS} = 15\text{ V}$ (Nominal Defined as Average Value Within a Range of 65% to 75% Maximum Load)

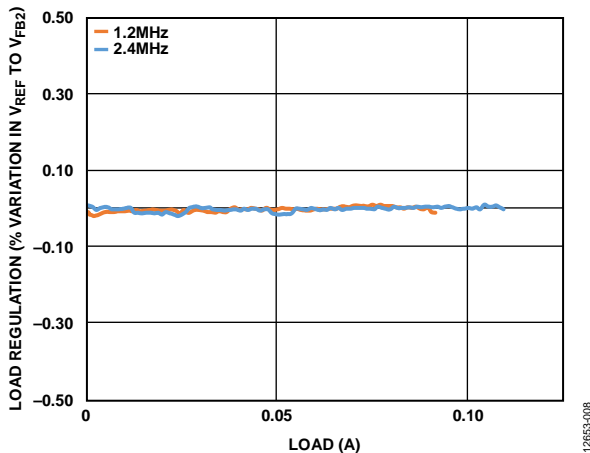

Figure 8. Inverting Regulator Load Regulation, $V_{IN} = 5\text{ V}$, $V_{NEG} = -15\text{ V}$ (Nominal Defined as Average Value Within a Range of 65% to 75% Maximum Load)

EFFICIENCY

For efficiency measurements, monitor the regulator input and output while the load is varied. The input voltage must be held constant during this measurement. Keep power leads short during this test and use a power supply with remote sense. Connect ammeters in series with the input and output. Connect voltmeters to the PCB side of the ammeter and measure the voltage across the input and output terminals. For the best results, measure the voltage across the input and output capacitors. If possible, particularly at low current, trigger the meters simultaneously and set to average readings for a period of a few hundred milliseconds or more. Averaging the readings removes the switching ripple and skip mode effects. Figure 9 and Figure 10 show typical efficiency curves using a 5 V input.

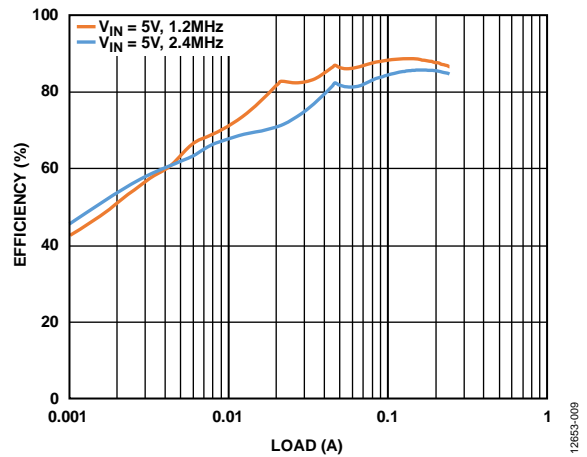

Figure 9. Boost Regulator Efficiency vs. Current Load, $V_{POS} = 15\text{ V}$, $T_A = 25^\circ\text{C}$

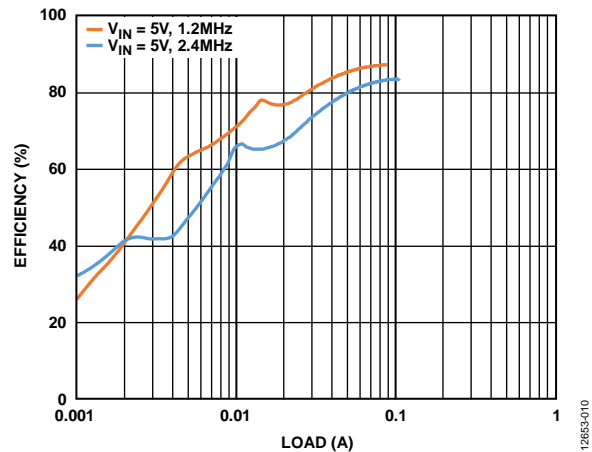

Figure 10. Inverting Regulator Efficiency vs. Current Load, $V_{NEG} = -15\text{ V}$, $T_A = 25^\circ\text{C}$

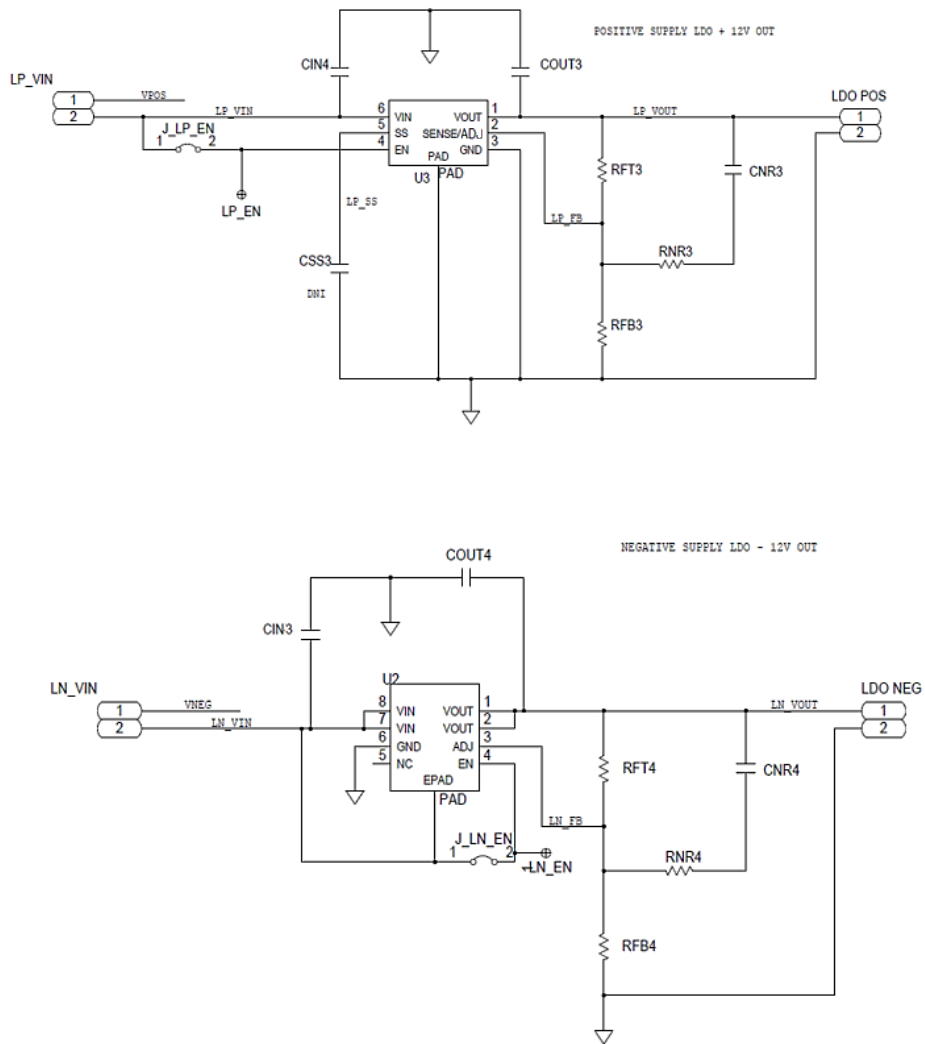

Figure 12. Evaluation Board Schematic for the Optional LDO Regulators (LFCSP Package Version)

12683-012

ORDERING INFORMATION

BILL OF MATERIALS

Table 2. Evaluation Board Components—ADP5070 Version

Component	Package	Description	Value	Tolerance	Voltage	Part Number	Manufacturer
U1	LFCSP	ADP5070 LFCSP	ADP5070				Analog Devices, Inc.
COU1	1210	V _{OUT1} capacitor	10 μ F	10%	50 V	GRM32ER71H106KA12L	Murata
COU2	1210	V _{OUT2} capacitor	10 μ F	10%	50 V	GRM32ER71H106KA12L	Murata
L1	XAL40XX	V _{OUT1} inductor	6.8 μ H	20%		XAL4030-682ME	Coilcraft
L2	XAL40XX	V _{OUT2} inductor	15 μ H	20%		XAL4030-153ME	Coilcraft
D1	PowerDi123	V _{OUT1} diode	Schottky		40 V	DFLS240	Diodes Incorporated
D2	PowerDi123	V _{OUT2} diode	Schottky		40 V	DFLS240	Diodes Incorporated
CC1	603	Boost regulator compensation capacitor	47 nF	10%	10 V		
CC2	603	Inverting regulator compensation capacitor	68 nF	10%	10 V		
RC1	603	Boost regulator compensation resistor	12 k Ω	1%			
RC2	603	Inverting regulator compensation resistor	10 k Ω	1%			
RFT1	805	V _{OUT1} top feedback resistor	2.43 M Ω	1%			
RFB1	805	V _{OUT1} bottom feedback resistor	137 k Ω	1%			
RFT2	805	V _{OUT2} top feedback resistor	2.32 M Ω	1%			
RFB2	805	V _{OUT2} bottom feedback resistor	118 k Ω	1%			
CIN1	1206	C _{IN} capacitor	10 μ F	10%	25 V	TMK316B7106KL-TD	Taiyo Yuden
CVREG	805	V _{REG} capacitor	1 μ F	10%	10 V	GRM188R71A105KA61D	Murata
CVREF	805	V _{REF} capacitor	1 μ F	10%	10 V	GRM188R71A105KA61D	Murata
JP5		Solder jumper Compensation 1	Bridge dot side				
JP6		Solder jumper Compensation 2	Bridge dot side				
COU1B	1210	V _{OUT1} capacitor	Not installed	10%			
COU2B	1210	V _{OUT2} capacitor	Not installed	10%			
CHF3	603	Compensation 1 high frequency capacitor	Not installed	10%			
CHF4	603	Compensation 2 high frequency capacitor	Not installed	10%			
CFF1	603	Feedforward Capacitor 1	Not installed	10%			
CFF2	603	Feedforward Capacitor 2	Not installed	10%			
RFF1	805	Feedforward Resistor 1	Not installed	1%			
RFF2	805	Feedforward Resistor 2	Not installed	1%			

Table 3. Evaluation Board Components—ADP5071 Version

Component	Package	Description	Value	Tolerance	Voltage	Part Number	Manufacturer
U1	LFCSP	ADP5071 LFCSP	ADP5071				Analog Devices
COUT1	1210	V _{OUT1} capacitor	10 μ F	10%	50 V	GRM32ER71H106KA12L	Murata
COUT2	1210	V _{OUT2} capacitor	10 μ F	10%	50 V	GRM32ER71H106KA12L	Murata
L1	XAL40xx	V _{OUT1} inductor	4.7 μ H	20%		XAL4030-472ME	Coilcraft
L2	XAL40xx	V _{OUT2} inductor	6.8 μ H	20%		XAL4030-682ME	Coilcraft
D1	PowerDi123	V _{OUT1} diode	Schottky		40 V	DFLS240	Diodes Incorporated
D2	PowerDi123	V _{OUT2} diode	Schottky		40 V	DFLS240	Diodes Incorporated
CC1	603	Compensation 1 capacitor	47 nF	10%	10 V		
CC2	603	Compensation 2 capacitor	47 nF	10%	10 V		
RC1	603	Compensation 1 zero resistor	5.6 k Ω	1%			
RC2	603	Compensation 2 zero resistor	6.8 k Ω	1%			
RFT1	805	V _{OUT1} top feedback resistor	2.43 M Ω	1%			
RFB1	805	V _{OUT1} bottom feedback resistor	137 k Ω	1%			
RFT2	805	V _{OUT2} top feedback resistor	2.32 M Ω	1%			
RFB2	805	V _{OUT2} bottom feedback resistor	118 k Ω	1%			
CIN1	1206	C _{IN} capacitor	10 μ F	10%	25 V	TMK316B7106KL-TD	Taiyo Yuden
CVREG	805	V _{REG} capacitor	1 μ F	10%	10 V	GRM188R71A105KA61D	Murata
CVREF	805	V _{REF} capacitor	1 μ F	10%	10 V	GRM188R71A105KA61D	Murata
JP5		Solder jumper Compensation 1	Bridge dot side				
JP6		Solder jumper Compensation 2	Bridge dot side				
COUT1B	1210	V _{OUT1} capacitor	Not installed	10%			
COUT2B	1210	V _{OUT2} capacitor	Not installed	10%			
CHF3	603	Compensation 1 high frequency capacitor	Not installed	10%			
CHF4	603	Compensation 2 high frequency capacitor	Not installed	10%			
CFF1	603	Feedforward Capacitor 1	Not installed	10%			
CFF2	603	Feedforward Capacitor 2	Not installed	10%			
RFF1	805	Feedforward Resistor 1	Not installed	1%			
RFF2	805	Feedforward Resistor 2	Not installed	1%			

Table 4. Evaluation Board Components—LDO Regulators and Miscellaneous Components

Component	Package	Description	Value	Tolerance	Voltage	Part Number	Manufacturer
U3	LFCSP	ADP7142 positive LDO	ADP7142			ADP7142	Analog Devices
CIN4	0805	Positive LDO input capacitor	2.2 μ F	10%	25 V		
COU3	0805	Positive LDO output capacitor	2.2 μ F	10%	25 V		
RFT3	0603	Positive LDO top feedback resistor	90.9 k Ω	1%			
RFB3	0603	Positive LDO bottom feedback resistor	10 k Ω	1%			
CNR3	0603	Positive LDO noise reduction capacitor	100 nF	10%	25 V		
RNR3	0603	Positive LDO noise reduction resistor	1 k Ω	1%			
CSS3	0805	Positive LDO soft start capacitor	1 nF	10%	25 V	Any	Any
J_LP_EN U2	0603 LFCSP	Enable jumper ADP7182 negative LDO	0 Ω link ADP7182			ADP7182	Analog Devices
CIN3	0805	Negative LDO input capacitor	2.2 μ F	10%	25 V		
COU4	0805	Negative LDO output capacitor	2.2 μ F	10%	25 V		
RFT4	0603	Negative LDO top feedback resistor	5.9 k Ω	1%		Any	Any
RFB4	0603	Negative LDO bottom feedback resistor	52.3 k Ω	1%		Any	Any
CNR4	0603	Negative LDO noise reduction capacitor	100 nF	10%	25 V	Any	Any
RNR4	0603	Negative LDO noise reduction resistor	619 Ω	1%		Any	Any
J_LN_EN RSS	0603 0603	Enable jumper Soft start resistor	0 Ω link 49.9 k Ω	1%		Any	Any
CR1	SOD123	Enable Zener diode	MMSZ5233B-7-F		6 V	MMSZ5233B-7-F	Diodes Incorporated
R7	0603	Enable divider resistor	14.3 k Ω	1%		Any	Any
R8	0603	Enable divider resistor	14.3 k Ω	1%		Any	Any
SYNC/FREQ, SEQ, SLEW, EN1, EN2	2.54 mm	Option headers	3-pin header			Any	Any
LP_VIN, LN_VIN, SS	2.54 mm	Option headers	2-pin header			Any	Any

NOTES



ESD Caution

ESD (electrostatic discharge) sensitive device. Charged devices and circuit boards can discharge without detection. Although this product features patented or proprietary protection circuitry, damage may occur on devices subjected to high energy ESD. Therefore, proper ESD precautions should be taken to avoid performance degradation or loss of functionality.

Legal Terms and Conditions

By using the evaluation board discussed herein (together with any tools, components documentation or support materials, the "Evaluation Board"), you are agreeing to be bound by the terms and conditions set forth below ("Agreement") unless you have purchased the Evaluation Board, in which case the Analog Devices Standard Terms and Conditions of Sale shall govern. Do not use the Evaluation Board until you have read and agreed to the Agreement. Your use of the Evaluation Board shall signify your acceptance of the Agreement. This Agreement is made by and between you ("Customer") and Analog Devices, Inc. ("ADI"), with its principal place of business at One Technology Way, Norwood, MA 02062, USA. Subject to the terms and conditions of the Agreement, ADI hereby grants to Customer a free, limited, personal, temporary, non-exclusive, non-sublicensable, non-transferable license to use the Evaluation Board FOR EVALUATION PURPOSES ONLY. Customer understands and agrees that the Evaluation Board is provided for the sole and exclusive purpose referenced above, and agrees not to use the Evaluation Board for any other purpose. Furthermore, the license granted is expressly made subject to the following additional limitations: Customer shall not (i) rent, lease, display, sell, transfer, assign, sublicense, or distribute the Evaluation Board; and (ii) permit any Third Party to access the Evaluation Board. As used herein, the term "Third Party" includes any entity other than ADI, Customer, their employees, affiliates and in-house consultants. The Evaluation Board is NOT sold to Customer; all rights not expressly granted herein, including ownership of the Evaluation Board, are reserved by ADI. CONFIDENTIALITY. This Agreement and the Evaluation Board shall all be considered the confidential and proprietary information of ADI. Customer may not disclose or transfer any portion of the Evaluation Board to any other party for any reason. Upon discontinuation of use of the Evaluation Board or termination of this Agreement, Customer agrees to promptly return the Evaluation Board to ADI. ADDITIONAL RESTRICTIONS. Customer may not disassemble, decompile or reverse engineer chips on the Evaluation Board. Customer shall inform ADI of any occurred damages or any modifications or alterations it makes to the Evaluation Board, including but not limited to soldering or any other activity that affects the material content of the Evaluation Board. Modifications to the Evaluation Board must comply with applicable law, including but not limited to the RoHS Directive. TERMINATION. ADI may terminate this Agreement at any time upon giving written notice to Customer. Customer agrees to return to ADI the Evaluation Board at that time. LIMITATION OF LIABILITY. THE EVALUATION BOARD PROVIDED HEREUNDER IS PROVIDED "AS IS" AND ADI MAKES NO WARRANTIES OR REPRESENTATIONS OF ANY KIND WITH RESPECT TO IT. ADI SPECIFICALLY DISCLAIMS ANY REPRESENTATIONS, ENDORSEMENTS, GUARANTEES, OR WARRANTIES, EXPRESS OR IMPLIED, RELATED TO THE EVALUATION BOARD INCLUDING, BUT NOT LIMITED TO, THE IMPLIED WARRANTY OF MERCHANTABILITY, TITLE, FITNESS FOR A PARTICULAR PURPOSE OR NONINFRINGEMENT OF INTELLECTUAL PROPERTY RIGHTS. IN NO EVENT WILL ADI AND ITS LICENSORS BE LIABLE FOR ANY INCIDENTAL, SPECIAL, INDIRECT, OR CONSEQUENTIAL DAMAGES RESULTING FROM CUSTOMER'S POSSESSION OR USE OF THE EVALUATION BOARD, INCLUDING BUT NOT LIMITED TO LOST PROFITS, DELAY COSTS, LABOR COSTS OR LOSS OF GOODWILL. ADI'S TOTAL LIABILITY FROM ANY AND ALL CAUSES SHALL BE LIMITED TO THE AMOUNT OF ONE HUNDRED US DOLLARS (\$100,000). EXPORT. Customer agrees that it will not directly or indirectly export the Evaluation Board to another country, and that it will comply with all applicable United States federal laws and regulations relating to exports. GOVERNING LAW. This Agreement shall be governed by and construed in accordance with the substantive laws of the Commonwealth of Massachusetts (excluding conflict of law rules). Any legal action regarding this Agreement will be heard in the state or federal courts having jurisdiction in Suffolk County, Massachusetts, and Customer hereby submits to the personal jurisdiction and venue of such courts. The United Nations Convention on Contracts for the International Sale of Goods shall not apply to this Agreement and is expressly disclaimed.

©2015 Analog Devices, Inc. All rights reserved. Trademarks and registered trademarks are the property of their respective owners.
UG12653-0-3/15(10)



www.analog.com