

PART NUMBER		SML-LX851SIUPGUBC	REV	D
REV	E.C.N. NUMBER AND REVISION COMMENTS			DATE
A	E.C.N. #11148			08.28.07
B	E.C.N. #11710/10BRDR. & REDRAWN			05.16.11
C	E.C.N. #11911			07.02.14
D	ECN-Lumex201700009			04.10.17

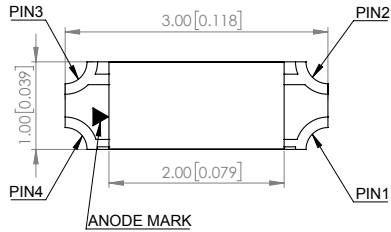

POLARITY

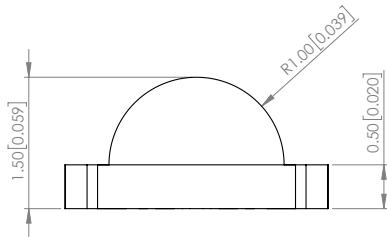
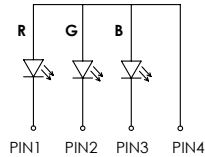

RECOMMENDED SOLDER PAD LAYOUT

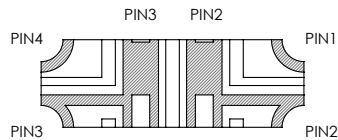
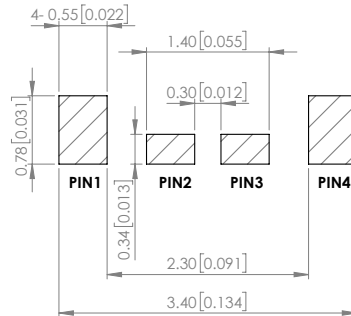

ELECTRO-OPTICAL CHARACTERISTIC TA=25°C

PARAMETER		MIN	TYP	MAX	UNITS	TEST COND
PEAK WAELENGHT	R	-	636	-	nm	If=20mA
	G	-	525	-		
	B	-	470	-		
FORWARD VOLTAGE	R	-	2	2.4	Vf	If=20mA
	G	-	3	3.4		
	B	-	3	3.4		
REVERSE VOLTAGE (R/GB)		-	-	5	Vr	IR=10/50/50uA
LUMINOUS INTENSITY	R	-	130	-	mcd	If=20mA
	G	-	210	-		
	B	-	70	-		
VIEWING ANGLE		-	100	-	2x theta1/2	If=20mA
EMITTED COLOR	R/G/B					
EPOXY LENS FINISH	WATER CLEAR					

ABSOLUTE MAXIMUM RATINGS TA=25°C

PARAMETER	MAX	UNITS
PEAK FORWARD CURRENT (R/G/B)*	60/100/100	mA
FORWARD CURRENT (R/G/B)	25/25/25	mA
POWER DISIPATION (R/G/B)	60/110/110	mW
STORAGE TEMPERATURE	-40 to +85	°C
OPERATING TEMPERATURE	-40 to +85	°C

*t<10us

CUSTOM: MOISTURE SENSITIVE DEVICE
PER JEDEC LEVEL 3 STANDARDS

*UNLESS OTHERWISE SPECIFIED TOLERANCES PER DECIMAL PRECISION ARE: X=±1 (±0.039), X.X=±0.5 (±0.020), X.XX=±0.25 (±0.010), X.XXX=±0.127 (±0.005). LEAD SIZE=±0.05 (±0.002), LEAD LENGTH=±0.75 (±0.030), MIN= ^{+0.00}/_{-0.00} DECIMAL PRECISION MAX= ^{+0.00}/_{-0.00} DECIMAL PRECISION

 <p>425 N. GARY AVE. CAROL STREAM, IL 60188 PHONE : 800-278-5666 FAX : 630-315-2150 WEB : WWW.LUMEX.COM</p>	3.0(L)*1.0(W)*1.5(H)mm, SURFACE MOUNT SIDE VIEW LED, AlInGaP RED/InGaP GREEN/InGaP BLUE LED, WATER CLEAR LENS, TAPE & REEL	DATE : 2017.04.10	DRAWN BY : E.C.
	<p>***THE SPECIFICATIONS MAY CHANGE AT ANY TIME WITHOUT NOTICE DUE TO NEW MATERIALS OR PRODUCT IMPROVEMENT.***</p> <p>CONFIDENTIAL INFORMATION</p> <p>THE INFORMATION CONTAINED IN THIS DOCUMENT IS THE PROPERTY OF LUMEX INC. EXCEPT AS SPECIFICALLY AUTHORIZED IN WRITING BY LUMEX INC., THE HOLDER OF THIS DOCUMENT SHALL KEEP ALL INFORMATION CONTAINED HEREIN CONFIDENTIAL AND SHALL PROTECT SAME IN WHOLE OR IN PART FROM DISCLOSURE AND DISSEMINATION TO ALL THIRD PARTIES.</p>	PAGE : 1 OF 2	CHKD BY : G.Y.
		SCALE : NTF	APRVD BY : R.C.
		UNIT : mm [INCH]	(P)

PART NUMBER	SML-LX851SIUPGUBC	REV	D
REV	E.C.N. NUMBER AND REVISION COMMENTS		DATE
A	E.C.N. #11148		08.28.07
B	E.C.N. #11710/10BRDR. & REDRAWN		05.16.11
C	E.C.N. #11911		07.02.14
D	ECN-Lumex201700009		04.10.17

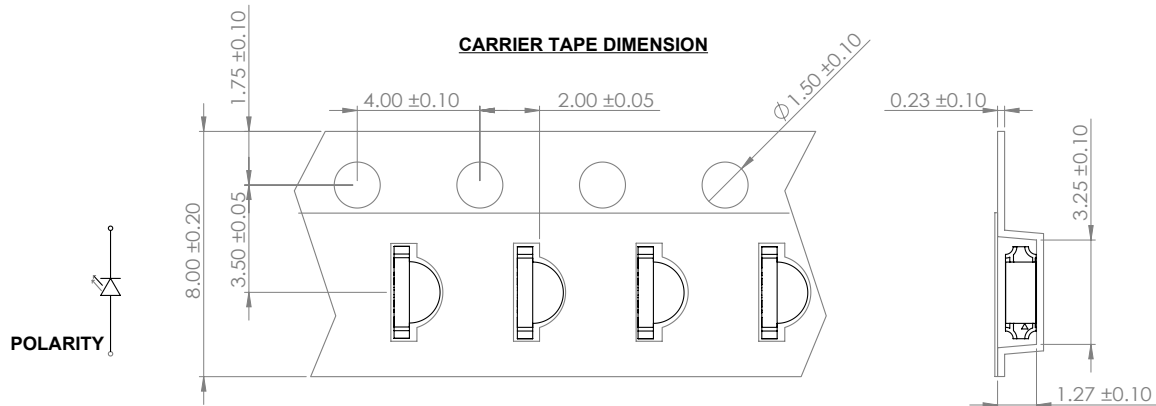
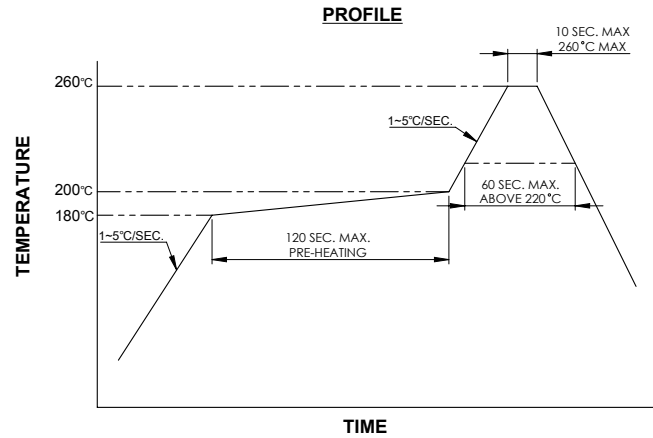

*UNLESS OTHERWISE SPECIFIED TOLERANCES PER DECIMAL PRECISION ARE: X=±1 (±0.039), X.X=±0.5 (±0.020), X.XX=±0.25 (±0.010), X.XXX=±0.127 (±0.005). LEAD SIZE=±0.05 (±0.002), LEAD LENGTH=±0.75 (±0.030), MIN= ^{+0.00}DECIMAL PRECISION _{-0.00} MAX= ^{+0.00}DECIMAL PRECISION _{-0.00}

 <p>425 N. GARY AVE. CAROL STREAM, IL 60188 PHONE : 800-278-5666 FAX : 630-315-2150 WEB : WWW.LUMEX.COM</p>	3.0(L)*1.0(W)*1.5(H)mm, SURFACE MOUNT SIDE VIEW LED, AllnGap RED/InGaN GREEN/InGaN BLUE LED, WATER CLEAR LENS, TAPE & REEL	DATE : 2017.04.10	DRAWN BY : E.C.
	THE SPECIFICATIONS MAY CHANGE AT ANY TIME WITHOUT NOTICE DUE TO NEW MATERIALS OR PRODUCT IMPROVEMENT.	PAGE : 2 OF 2	CHKD BY : G.Y.
<small>CONFIDENTIAL INFORMATION</small> THE INFORMATION CONTAINED IN THIS DOCUMENT IS THE PROPERTY OF LUMEX INC. EXCEPT AS SPECIFICALLY AUTHORIZED IN WRITING BY LUMEX INC., THE HOLDER OF THIS DOCUMENT SHALL KEEP ALL INFORMATION CONTAINED HEREIN CONFIDENTIAL AND SHALL PROTECT SAME IN WHOLE OR IN PART FROM DISCLOSURE AND DISSEMINATION TO ALL THIRD PARTIES.		SCALE : NTF	APRVD BY : R.C.
		UNIT : mm [INCH]	(P)