



ISD400-7212

ISD400

OPTICAL DATA TRANSMISSION

SICK
Sensor Intelligence.



Illustration may differ



Ordering information

Type	Part no.
ISD400-7212	1065101

Data transmission requires two devices. The second device must be ordered separately.

Other models and accessories → www.sick.com/ISD400

Detailed technical data

Performance

Transmission range	0.2 m ... 150 m
Light source	Laser, red (660 nm) Laser, infrared (785 nm)
Laser class	1M (IEC 60825-1:2014, EN 60825-1:2014)
Typ. light spot size (distance)	1.75 m (at 100 m)
Aperture angle	1° (sender) 1.5° (receiver)

Interfaces

Ethernet	✓
Data transmission rate	100 Mbit/s
Switching output	HIGH: $U_v - 3\text{ V}$, LOW: $< 2\text{ V}$
Switching input	V_s : sender deactivated

Mechanics/electronics

Supply voltage V_s	DC 18 V ... 30 V
Power consumption	$\leq 3.6\text{ W}$ ^{1) 2)}
Housing material	AlSi12
Connection type	1 x Ethernet female connector M12, 4-pin, D-coded 1 x power supply male connector M12, 4-pin, A-coded
Weight	Approx. 800 g
Frequency	F2
Enclosure rating	IP65
Protection class	III

¹⁾ Without load.

²⁾ At 24 V.

Ambient data

Electromagnetic compatibility (EMC)	EN 61000-6-2, EN 61000-6-4 ¹⁾
Ambient temperature operation	-20 °C ... +55 °C -40 °C ... +75 °C, operation with cooling case

¹⁾ This is a Class A device. This device can cause radio interference in living quarters.

Ambient storage temperature	-40 °C ... +75 °C
Max. rel. humidity (not condensing)	90 %, Non-condensing

¹⁾ This is a Class A device. This device can cause radio interference in living quarters.

General notes

Note	Setting up a data transmission path requires a pair of devices, where one device has frequency F1 (ISD400-7xx1) and the other device has frequency F2 (ISD400-7xx2). A wide variety of Ethernet protocols can be used in protocol-free transmission (e.g., PROFINET, PROFI-safe, EtherNet/IP, EtherCAT, TCP/IP, etc.).
-------------	--

Classifications

ECI@ss 5.0	19039001
ECI@ss 5.1.4	19039001
ECI@ss 6.0	19179090
ECI@ss 6.2	19179090
ECI@ss 7.0	19179090
ECI@ss 8.0	19179090
ECI@ss 8.1	19179090
ECI@ss 9.0	19179090
ETIM 5.0	EC000515
ETIM 6.0	EC000515
UNSPSC 16.0901	43201404

Dimensional drawing (Dimensions in mm (inch))

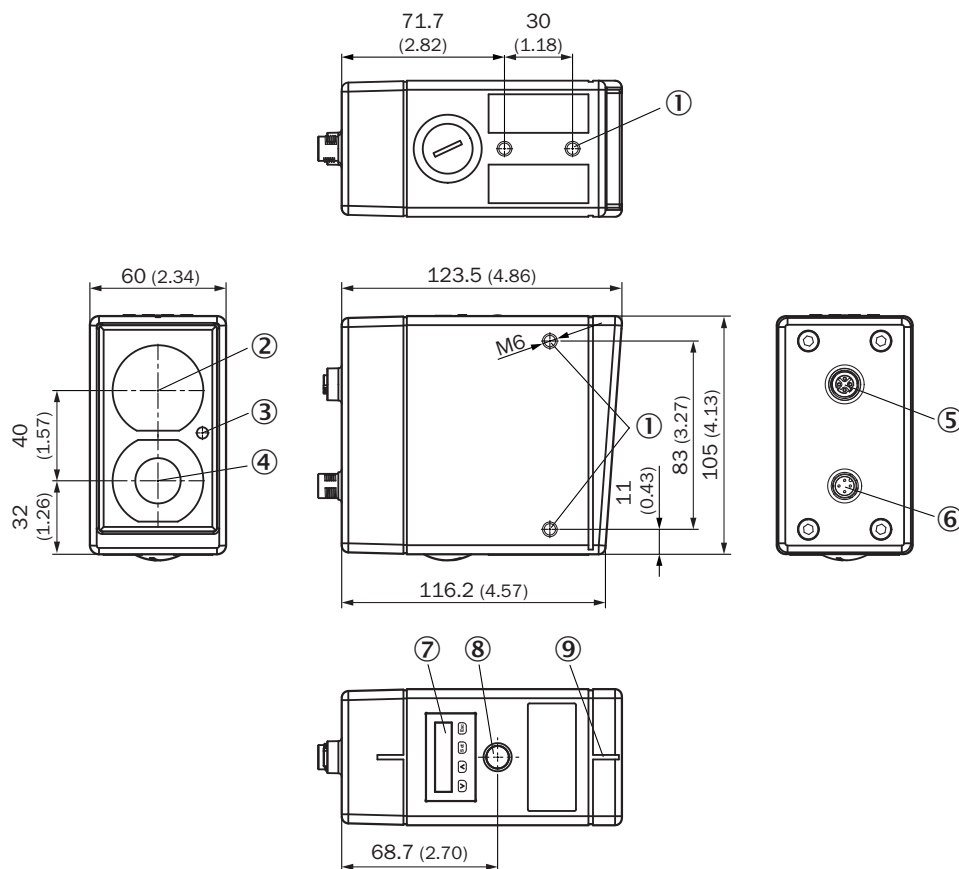

- ① Threaded mounting hole M6
- ② Center of optical axis, sender
- ③ Receive indicator
- ④ Center of optical axis, receiver
- ⑤ Ethernet female connector M12, 4-pin, D-coded
- ⑥ Power supply male connector M12, 4-pin, A-coded
- ⑦ Display with pushbuttons
- ⑧ Optical adjustment aid
- ⑨ Alignment sight

Connection type

Dx100 Ethernet female connector, M12, 4-pin, D-coded

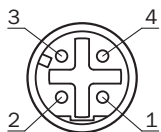

Dx100 PROFIBUS/PROFINET/CANopen/Ethernet/IP, M12 male connector, 4-pin, A-coded

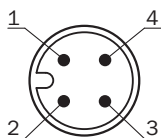

Connection diagram

Voltage supply connection diagram

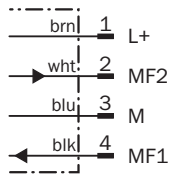

Ethernet M12 female connector, 4-pin

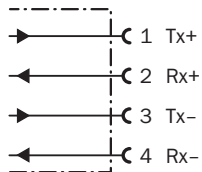

Adjustment possible

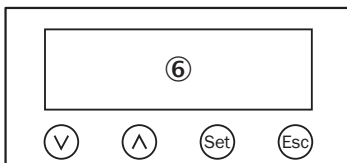

⑥ Liquid crystal display with function keys

Recommended accessories

Other models and accessories → www.sick.com/ISD400

	Brief description	Type	Part no.
Terminal and alignment brackets			
	Alignment unit for DME4000/ISD400, aluminum, anodised	BEF-DME/ISD	2046052

SICK AT A GLANCE

SICK is one of the leading manufacturers of intelligent sensors and sensor solutions for industrial applications. A unique range of products and services creates the perfect basis for controlling processes securely and efficiently, protecting individuals from accidents and preventing damage to the environment.

We have extensive experience in a wide range of industries and understand their processes and requirements. With intelligent sensors, we can deliver exactly what our customers need. In application centers in Europe, Asia and North America, system solutions are tested and optimized in accordance with customer specifications. All this makes us a reliable supplier and development partner.

Comprehensive services complete our offering: SICK LifeTime Services provide support throughout the machine life cycle and ensure safety and productivity.

For us, that is “Sensor Intelligence.”

WORLDWIDE PRESENCE:

Contacts and other locations –www.sick.com