

### GT3A Series – Analog Timers

**Key features:**

- 4 selectable operation modes on each model
- External start, reset, and gate inputs
- Panel mount or socket mount
- Large variety of timing functions
- Power and output status indicating LEDs



**Specifications**

	GT3A-1	GT3A-2	GT3A-3	GT3A-4,-5,-6
Operation	Multi-mode		Multi-mode with inputs (11 pins)	
Time Range	0.1s to 180 hours			
Rated Voltage	100 to 240V AC, 50/60Hz 12V DC 24V AC, 50/60Hz / 24V DC			
Contact Ratings	125V AC/250V AC, 3A; 30V DC, 1A (resistive load)		125V AC/250V AC, 5A; 30V DC, 5A (resistive load)	
Minimum Applicable Load	5V, 10mA (reference value)			
Voltage Tolerance	AF20 (100V AC): 85 to 264V AC AD24: 20.4 to 26.4V AC/21.6 to 26.4V DC D12: 10.8 to 13.2V DC			
Error	±0.2%, ±10 msec (repeat, voltage, temperature)			
Setting Error	±10% maximum			
Reset Time	60msec maximum			
Insulation Resistance	100MW minimum			
Dielectric Strength	Between power and output terminals: 2,000V AC, 1 minute Between contacts of different poles: 2,000V AC, 1 minute Between contacts of the same pole: 750V AC, 1 minute			
Power Consumption (approximate)	Delayed SPDT	Delayed SPDT + instantaneous SPDT	Delayed DPDT	Delayed DPDT
	10.8VA (200V AC, 60Hz)	13.5VA (200V AC, 60Hz)	14.4VA (200V AC, 60Hz)	4.7VA (100V AC, 60Hz), 14.4VA (200V AC, 60Hz)
	—	12VDC/1W 24VDC/0.7W 24VAC/1.2VA	12VDC/1.1W 24VDC/0.6W 24VAC/1.3VA	12VDC/0.8W 24VDC/0.6W 24VAC/1.3VA
Mechanical Life	10,000,000 operations minimum		5,000,000 operations minimum	
Electrical Life	50,000 operations minimum (rated load)		100,000 operations minimum (rated load)	
Weight (approximate)	63g	73g	79g	80g
Vibration Resistance	100m/sec <sup>2</sup> (approximate 10G)			
Shock Resistance	Operating extremes: 100m/sec <sup>2</sup> (approximate 10G) Damage limits: 500m/sec <sup>2</sup> (approximate 50G)			
Operating Temperature	-10 to +50°C			
Operating Humidity	45 to 85% RH			
Storage Temperature	-30 to +80°C			
Housing Color	Gray			

Switches & Pilot Lights

Signaling Lights

Relays & Sockets

Timers

Contactors

Terminal Blocks

Circuit Breakers

## Part Numbers

## GT3A-1, -2, -3

Mode Of Operation	Rated Voltage Code	Time Range	Output	Contact	Complete Part No.	
					8-Pin	11-Pin
A: ON-delay 1 B: Interval 1 C: Cycle 1 D: Cycle 3	AF20: 100 to 240V AC (50/60Hz)	0.1 seconds to 180 hours	250V AC, 3A, 30V DC, 1A (resistive load)	Delayed SPDT	GT3A-1AF20	GT3A-1EAF20
	AF20: 100 to 240V AC (50/60Hz) D12: 12V DC AD24: 24V AC (50/60Hz)/24V DC				Delayed SPDT + Instantaneous SPDT	GT3A-2AF20
				GT3A-2D12		GT3A-2ED12
	Delayed DPDT		GT3A-2AD24	GT3A-2EAD24		
			GT3A-3AF20	GT3A-3EAF20		
			GT3A-3D12	GT3A-3ED12		
GT3A-3AD24	GT3A-3EAD24					

1. For wiring schematics and timing diagrams for GT3A-1, -2, -3, see pages page 940 and page 941 respectively.
2. For more details about time ranges, see instructions on page page 940.
3. For socket and accessory part numbers, see page 958.

## GT3A-4, -5, -6

Mode of Operation	Rated Voltage Code	Time Range	Output	Contact	Input	Complete Part No.	
						A (11-pin)	B (11-pin)
A: ON-Delay 2 B: Cycle 2 C: Signal ON/OFF-Delay 1 D: Signal OFF-Delay 1	AF20: 100 to 240V AC (50/60Hz) D12: 12V DC AD24: 24V AC (50/60Hz)/24V DC	0.1 seconds to 180 hours	250V AC, 5A, 24V DC, 5A (resistive load)	Delayed DPDT	Start Reset Gate	GT3A-4AF20	GT3A-4EAF20
						GT3A-4D12	GT3A-4ED12
						GT3A-4AD24	GT3A-4EAD24
A: Interval 2 B: One-Shot Cycle C: Signal ON/OFF-Delay 2 D: Signal OFF-Delay 2	AF20: 100 to 240V AC (50/60Hz) AD24: 24V AC (50/60Hz)/24V DC	0.1 seconds to 180 hours	250V AC, 5A, 24V DC, 5A (resistive load)	Delayed DPDT	Start Reset Gate	GT3A-5AF20	GT3A-5EAF20
						GT3A-5AD24	GT3A-5EAD24
A: One-Shot B: One-Shot ON-Delay C: One-Shot 2 D: Signal ON/OFF-Delay 3	AF20: 100 to 240V AC (50/60Hz) AD24: 24V AC (50/60Hz)/24V DC	0.1 seconds to 180 hours	250V AC, 5A, 24V DC, 5A (resistive load)	Delayed DPDT	Start Reset Gate	GT3A-6AF20	GT3A-6EAF20
						GT3A-6AD24	GT3A-6EAD24

4. For wiring schematics and timing diagrams GT3A-4,-5,-6, see pages 940, 941, and 941 respectively.
5. For more details about time ranges, see instructions on page 940.
6. A (11-pin) and B (11-pin) differ in the way inputs are wired.
7. For socket and accessory part numbers, see page 958.
8. For the timing diagrams overview, see page 940.

Timing Diagrams/Schematics

GT3A-1 Timing Diagrams

Delayed SPDT

Operation Mode Selection

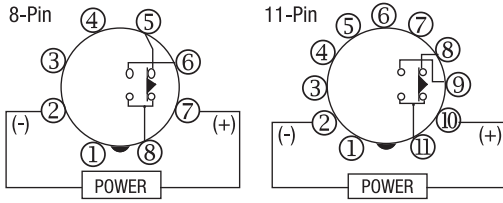

ON-Delay 1

MODE

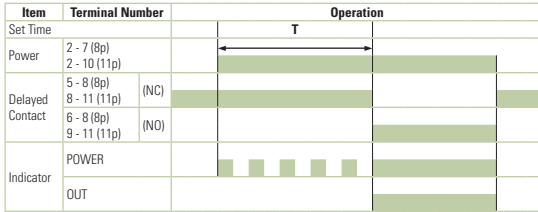

Interval 1

MODE

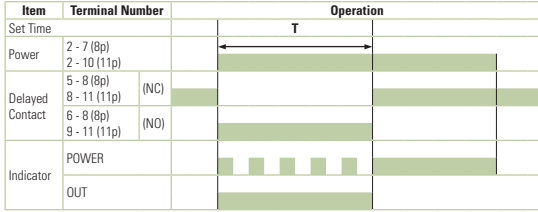

Cycle 1 (OFF first)

MODE

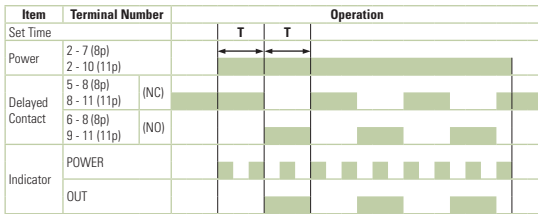

Cycle 3 (ON first)

MODE

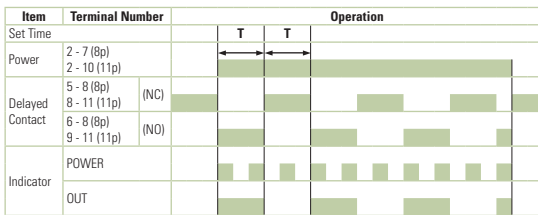

Switches & Pilot Lights

Signaling Lights

Relays & Sockets

Timers

Contactors

Terminal Blocks

Circuit Breakers

**GT3A-2 Timing Diagrams**  
**Delayed SPDT + Instantaneous SPDT**

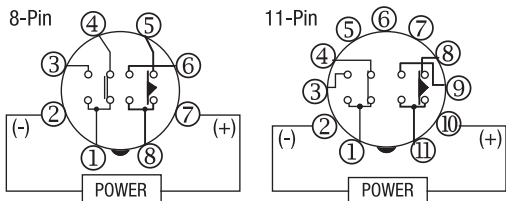

Operation Mode Selection

**ON-Delay 1**

MODE



Item	Terminal Number	Operation
Set Time	2 - 7 (8p) 2 - 10 (11p)	T
Power	5 - 8 (8p) 8 - 11 (11p) (NC)	[Green bar indicating power duration]
Delayed Contact	6 - 8 (8p) (NO) 9 - 11 (11p) (NO)	[Green bar indicating delayed contact closure]
Instantaneous Contact	1 - 4 (NC) 1 - 3 (NO)	[Green bar indicating instantaneous contact closure]
Indicator	POWER OUT	[Pulsed green bars indicating indicator activity]

**Interval 1**

MODE



Item	Terminal Number	Operation
Set Time	2 - 7 (8p) 2 - 10 (11p)	T
Power	5 - 8 (8p) 8 - 11 (11p) (NC)	[Green bar indicating power duration]
Delayed Contact	6 - 8 (8p) (NO) 9 - 11 (11p) (NO)	[Green bar indicating delayed contact closure]
Instantaneous Contact	1 - 4 (NC) 1 - 3 (NO)	[Green bar indicating instantaneous contact closure]
Indicator	POWER OUT	[Pulsed green bars indicating indicator activity]

**Cycle 1 (OFF first)**

MODE



Item	Terminal Number	Operation
Set Time	2 - 7 (8p) 2 - 10 (11p)	T, T
Power	5 - 8 (8p) 8 - 11 (11p) (NC)	[Green bar indicating power duration]
Delayed Contact	6 - 8 (8p) (NO) 9 - 11 (11p) (NO)	[Green bar indicating delayed contact closure]
Instantaneous Contact	1 - 4 (NC) 1 - 3 (NO)	[Green bar indicating instantaneous contact closure]
Indicator	POWER OUT	[Pulsed green bars indicating indicator activity]

**Cycle 3 (ON first)**

MODE



Item	Terminal Number	Operation
Set Time	2 - 7 (8p) 2 - 10 (11p)	T, T
Power	5 - 8 (8p) 8 - 11 (11p) (NC)	[Green bar indicating power duration]
Delayed Contact	6 - 8 (8p) (NO) 9 - 11 (11p) (NO)	[Green bar indicating delayed contact closure]
Instantaneous Contact	1 - 4 (NC) 1 - 3 (NO)	[Green bar indicating instantaneous contact closure]
Indicator	POWER OUT	[Pulsed green bars indicating indicator activity]

**GT3A-3 Timing Diagrams**  
**Delayed DPDT**

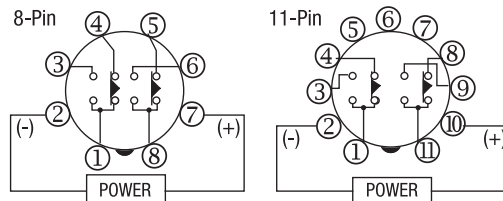

Operation Mode Selection

**ON-Delay 1**

MODE



Item	Terminal Number	Operation
Set Time	2 - 7 (8p) 2 - 10 (11p)	T
Power	1 - 4, 5 - 8 (8p) 1 - 4, 8 - 11 (11p) (NC)	[Green bar indicating power duration]
Delayed Contact	1 - 3, 6 - 8 (8p) (NO) 1 - 3, 9 - 11 (11p) (NO)	[Green bar indicating delayed contact closure]
Indicator	POWER OUT	[Pulsed green bars indicating indicator activity]

**Interval 1**

MODE



Item	Terminal Number	Operation
Set Time	2 - 7 (8p) 2 - 10 (11p)	T
Power	1 - 4, 5 - 8 (8p) (NC) 1 - 4, 8 - 11 (11p)	[Green bar indicating power duration]
Delayed Contact	1 - 3, 6 - 8 (8p) (NO) 1 - 3, 9 - 11 (11p)	[Green bar indicating delayed contact closure]
Indicator	POWER OUT	[Pulsed green bars indicating indicator activity]

**Cycle 1 (OFF first)**

MODE



Item	Terminal Number	Operation
Set Time	2 - 7 (8p) 2 - 10 (11p)	T, T
Power	1 - 4, 5 - 8 (8p) 1 - 4, 8 - 11 (11p) (NC)	[Green bar indicating power duration]
Delayed Contact	1 - 3, 6 - 8 (8p) (NO) 1 - 3, 9 - 11 (11p) (NO)	[Green bar indicating delayed contact closure]
Indicator	POWER OUT	[Pulsed green bars indicating indicator activity]

**Cycle 3 (ON first)**

MODE



Item	Terminal Number	Operation
Set Time	2 - 7 (8p) 2 - 10 (11p)	T, T
Power	1 - 4, 5 - 8 (8p) (NC) 1 - 4, 8 - 11 (11p)	[Green bar indicating power duration]
Delayed Contact	1 - 3, 6 - 8 (8p) (NO) 1 - 3, 9 - 11 (11p)	[Green bar indicating delayed contact closure]
Indicator	POWER OUT	[Pulsed green bars indicating indicator activity]

Note: Pins 1, 3, and 4 are the instantaneous contacts.

**GT3A-4 Timing Diagrams**  
**Delayed DPDT**

Operation  
Mode Selection

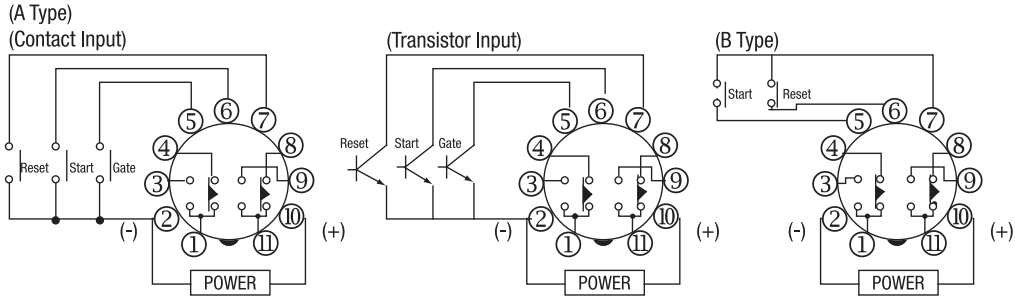

ON-Delay 2

MODE

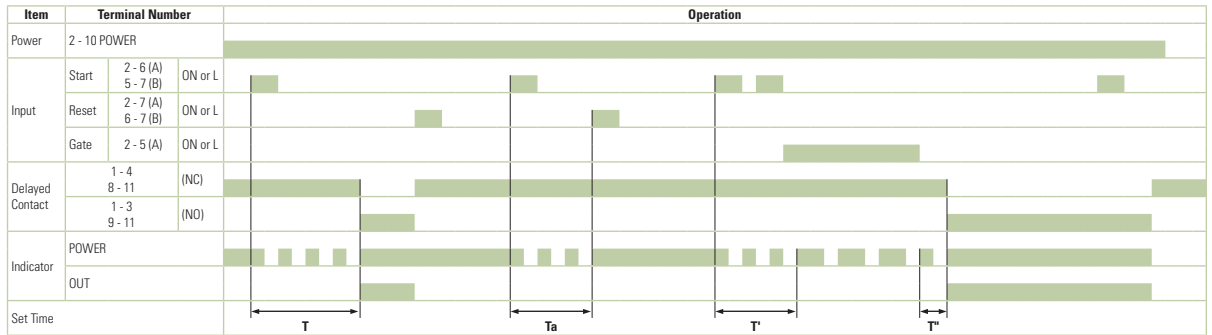

Cycle 2

MODE

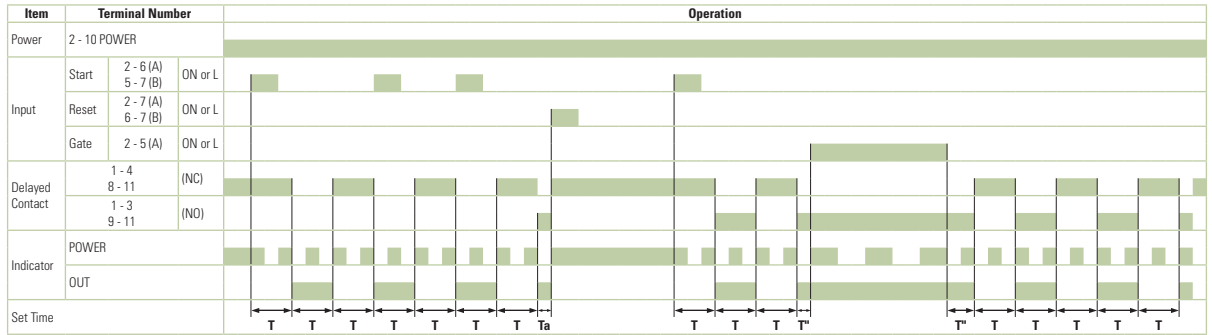

Signal ON/OFF-Delay 1

MODE

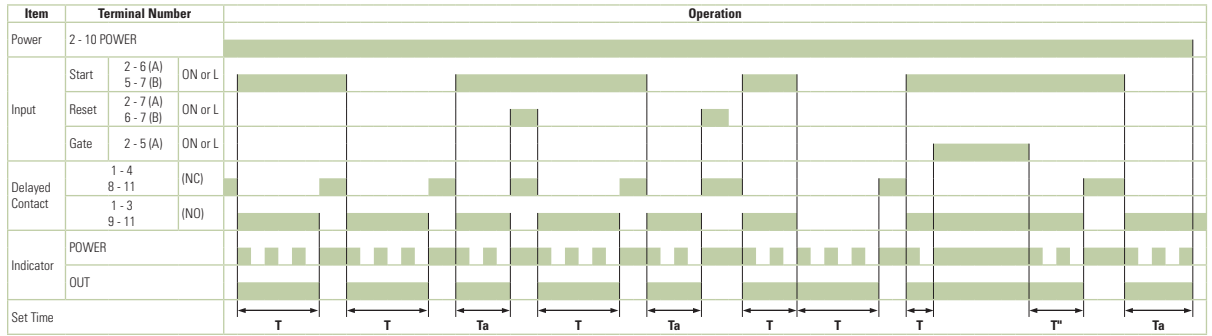

Signal OFF-Delay 1

MODE

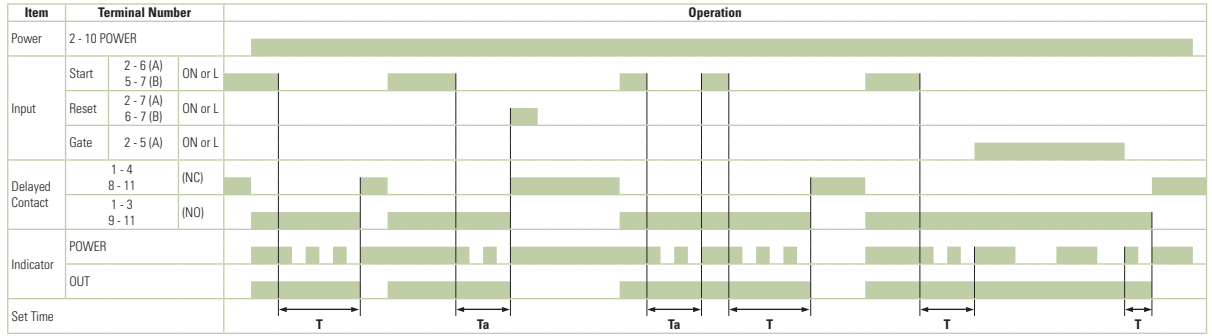

T = Set time Ta = Shorter than set time  
T = T' + T''

Switches & Pilot Lights

Signaling Lights

Relays & Sockets

Timers

Contactors

Terminal Blocks

Circuit Breakers

GT3A-5 Timing Diagrams  
Delayed DPDT

Switches & Pilot Lights

Signaling Lights

Relays & Sockets

Timers

Contactors

Terminal Blocks

Circuit Breakers

Operation  
Mode Selection

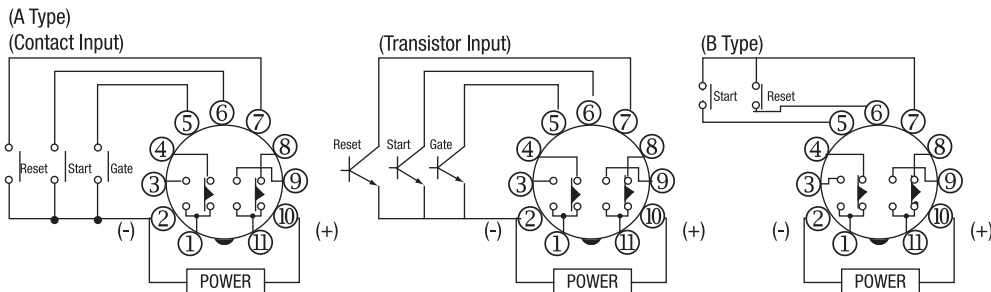

Interval 2

MODE

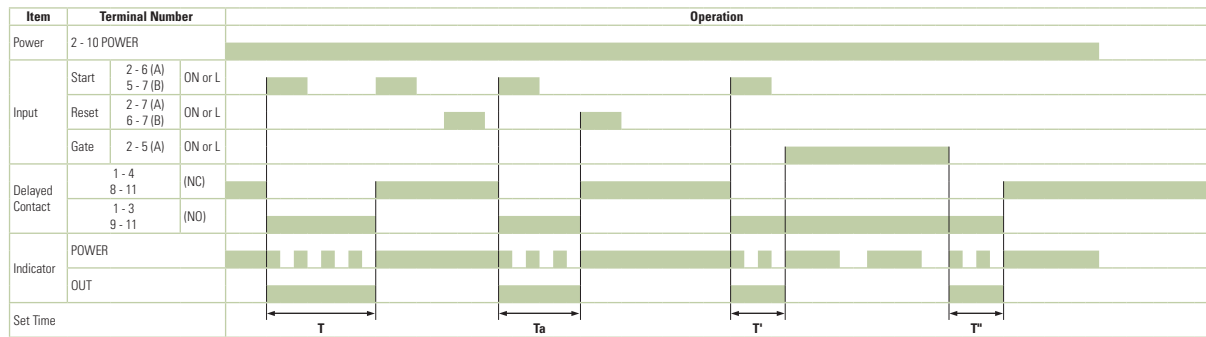

One-Shot Cycle

MODE

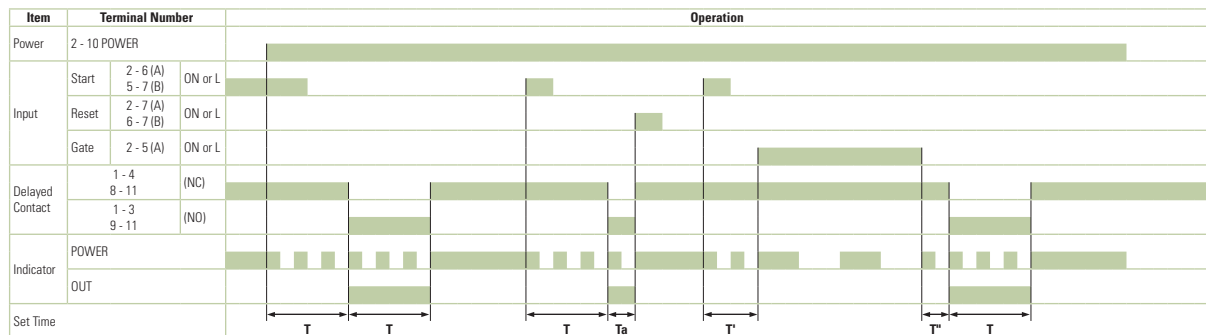

Signal ON/OFF-Delay 2

MODE

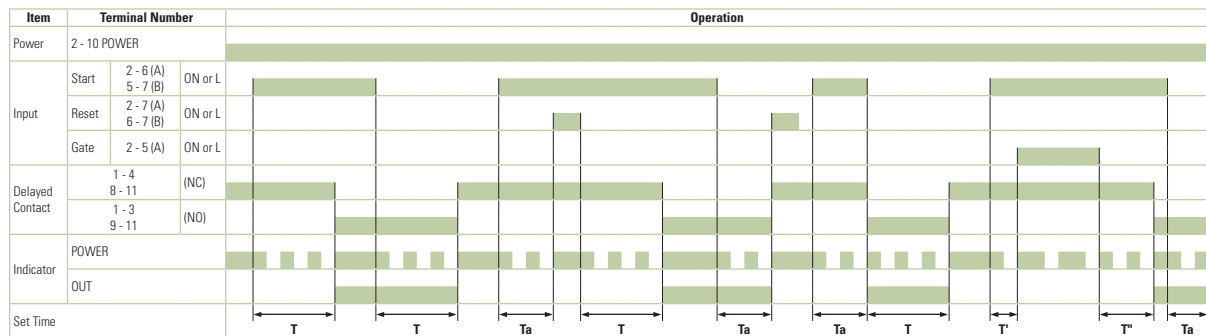

Signal OFF-Delay 2

MODE

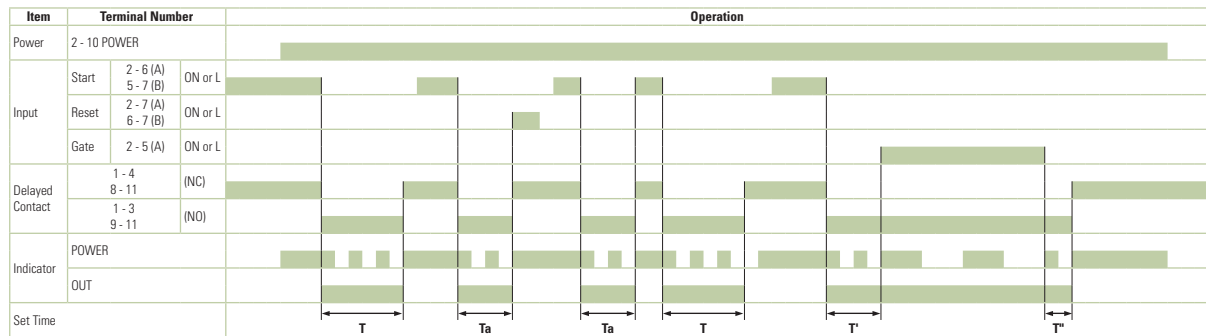

T = Set time Ta = Shorter than set time  
T = T' + T'

GT3A-6 Timing Diagrams  
Delayed DPDT

Operation  
Mode Selection

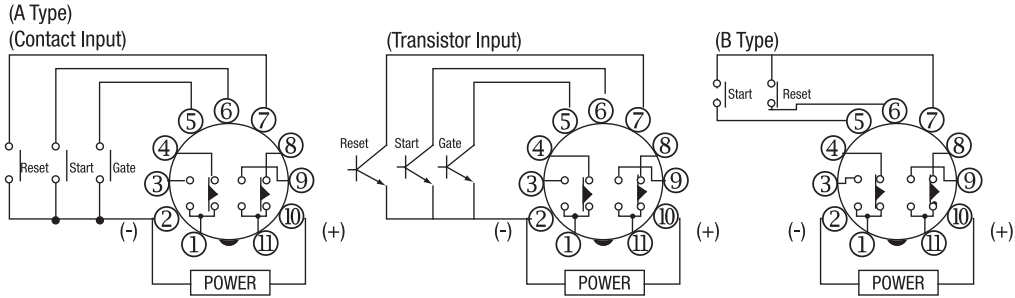

One-Shot 1

MODE

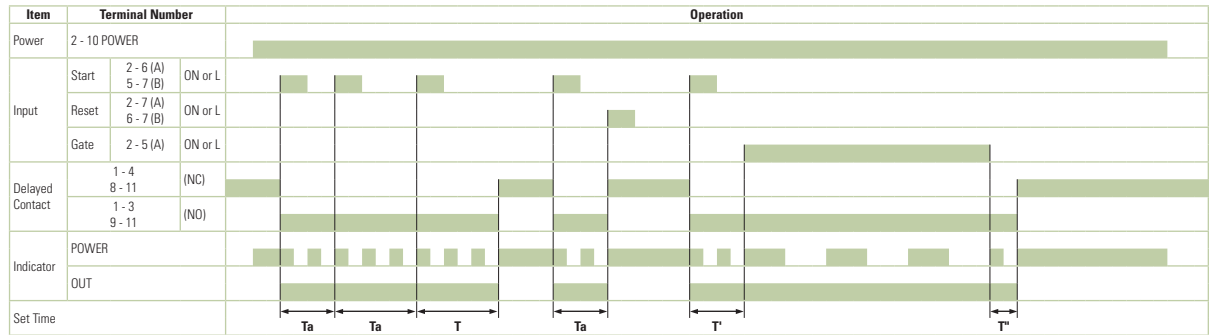

One-Shot ON-Delay

MODE

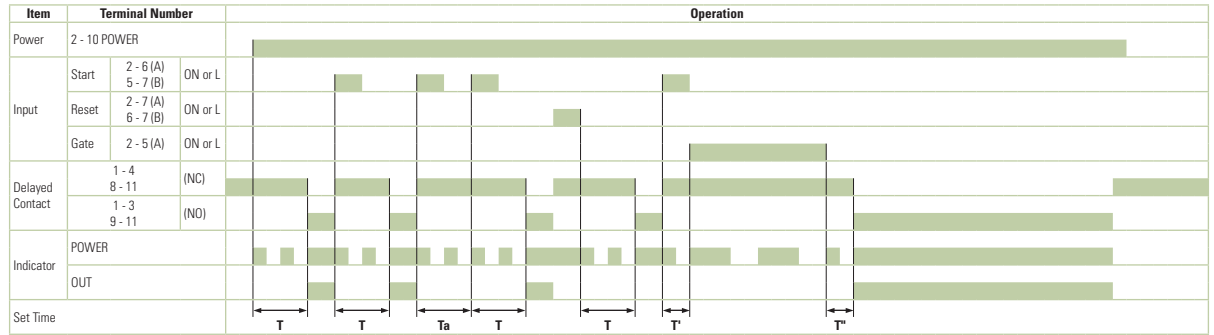

One-Shot 2

MODE

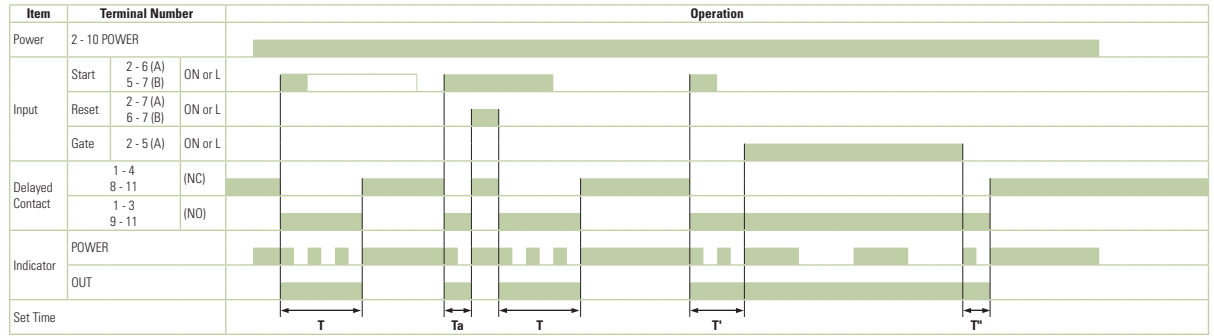

Signal ON/OFF-Delay 3

MODE

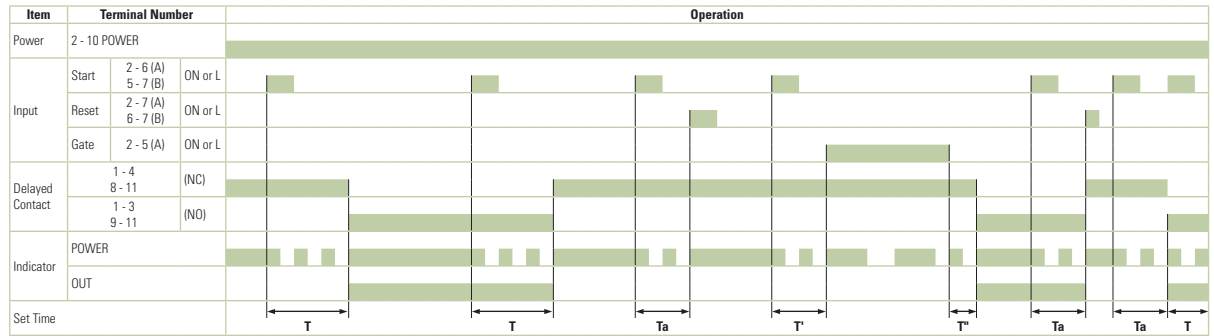

T = Set time Ta = Shorter than set time  
T = T' + T'

Switches & Pilot Lights

Signaling Lights

Relays & Sockets

Timers

Contactors

Terminal Blocks

Circuit Breakers

Instructions: Setting GT3A Series Timers

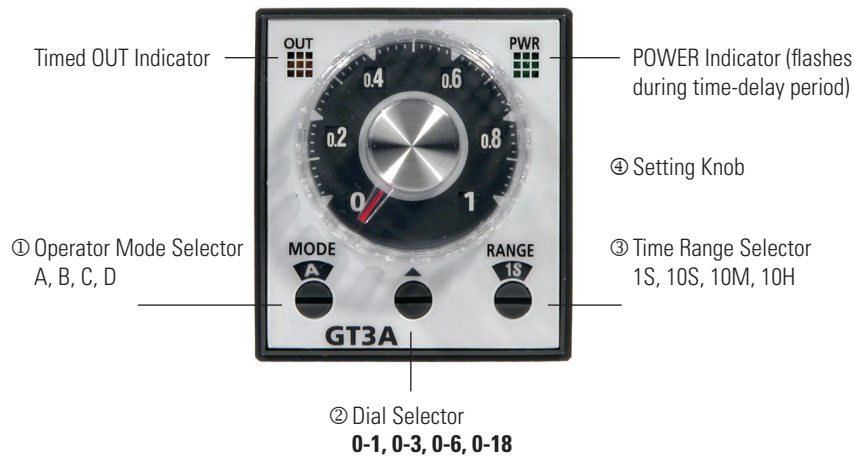

Step 1.	Desired Mode of Operation		Selection		Remarks
	<b>For Timers</b>	<b>Mode of Operation</b>	<b>① Operation Mode Selector</b>		
		ON-delay 1	A		
	GT3A-1	Interval 1	B		
	GT3A-2	Cycle 1	C		
	GT3A-3	Cycle 3	D		
		ON-delay 2	A		
	GT3A-4	Cycle 2	B		
		Signal ON/OFF-delay 1	C		
		Signal OFF-delay 1	D		
		Interval 2	A		
	GT3A-5	One-shot cycle	B		
		Signal ON/OFF-delay 2	C		
		Signal OFF-delay 2	D		
		One-shot 1	A		
	GT3A-6	One-shot ON-delay	B		
		One-shot 2	C		
		Signal ON/OFF-delay 3	D		
Select the desired mode of operation.					The desired operation mode can be selected from the A, B, C, and D modes using the Operation Mode Selector. Change the operation mode from A to B, C, and D in turn by turning the operation mode selector clockwise using a flat screwdriver which is a maximum of 0.156" (4mm) wide. The selected mode is displayed in the window.
Step 2.	Desired Time Range		Selection		Remarks
	<b>Time Ranges</b>		<b>② Dial Selector</b>	<b>③ Time Range Selector</b>	
	0.1 seconds to 1 second		0-1	1S	
	0.1 seconds to 3 seconds		0-3		
	0.1 seconds to 6 seconds		0-6		
	0.15 seconds to 18 seconds		0-18		
	0.1 seconds to 10 seconds		0-1	10S	
	0.3 seconds to 30 seconds		0-3		
	0.6 seconds to 60 seconds		0-6		
	1.8 seconds to 180 seconds		0-18	10M	
	6 seconds to 10 minutes		0-1		
	18 seconds to 30 minutes		0-3		
	36 seconds to 60 minutes		0-6		
	108 seconds to 180 minutes		0-18	10H	
	6 minutes to 10 hours		0-1		
	18 minutes to 30 hours		0-3		
	36 minutes to 60 hours		0-6		
	108 minutes to 180 hours		0-18		
Select the time range that contains the desired time period.					The desired time range is selected by setting both ② Dial Selector and ③ Time Range Selector.
Step 3.	<b>Selection</b>				
Set the precise period of time desired by using the ④ Setting Knob.					

Switches & Pilot Lights

Signaling Lights

Relays & Sockets

Timers

Contactors

Terminal Blocks

Circuit Breakers



## GT3F Series – True Power OFF Delay Timers

### Key features:

- “True” power OFF-delay up to 10 minutes
- No external control switch necessary
- Available with reset inputs
- Mountable in sockets or flush panel



### Specifications

	GT3F-1	GT3F-2
Operation	True power OFF-delay	
Time Range	0.1 seconds to 600 seconds	
Rated Voltage	100 to 240V AC, 50/60Hz 24V AC/DC	
Contact Rating	250V AC/24V DC, 5A (resistive load)	250V AC/24V DC, 3A (resistive load)
Contact Form	SPDT	DPDT
Minimum Power Application Time	1 second	
Voltage Tolerance	AF20: 100 to 240V AC AD24: 21.6 to 26.4VDC, 20.4 to 26.4VAC	
Repeat Error	±0.2%, ±10 msec	
Voltage Error	±0.2%, ±10 msec	
Temperature Error	±0.2%, ±10 msec	
Setting Error	±10% maximum	
Insulation Resistance	100MW minimum	
Dielectric Strength	Between power and output terminals: 2,000V AC, 1 minute (SPDT) 1,500V AC, 1 minute (DPDT) Between contacts on different poles: 1,000V AC, 1 minute (DPDT) Between contacts of the same pole: 750V AC, 1 minute	
Power Consumption	AF20: 3.7VA (200V AC, 60Hz) AD24: 0.8W (DC), 1.2VA (AC)	
Mechanical Life	3,000,000 operations minimum	
Electrical Life	100,000 operations minimum	
Vibration Resistance	100m/sec <sup>2</sup> (approximate 10G)	
Shock Resistance	Operating extremes: 100 m/sec <sup>2</sup> (approximate 10G) Damage limits: 500 m/sec <sup>2</sup> (approximate 50G)	
Operating Temperature	-10 to +50°C	
Storage Temperature	-30 to +80°C	
Operating Humidity	45 to 85% RH	
Weight (approximate)	77g	79g



1. An inrush current flows during the minimum power application time. AF20: approximate 0.4A, AD24: approximate 1.2A
2. GT3F does not read the preset time range shown on the knob after power is turned off. Note that minimizing the preset time, by turning the knob to zero, does not shorten the delay time after power is removed.

Part Numbering List

Mode of Operation	Rated Voltage Code	Time Range	Output	Contact	Optional Input	Complete Part Number	
						8-Pin	11-Pin
True-Power OFF-delay	AF20: 100 to 240VAC (50/60Hz)	0.1 seconds to 600 seconds	250V AC, 5A,	Delayed SPDT	Reset	GT3F-1AF20	GT3F-1EAF20
			30V DC, 5A (resistive load)			GT3F-1AD24	GT3F-1EAD24
	AD24: 24V AC/DC		250V AC, 3A,	Delayed DPDT	None (8p) Reset (11p)	GT3F-2AF20	GT3F-2EAF20
			30V DC, 3A (resistive load)			GT3F-2AD24	GT3F-2EAD24

 Optional reset input resets the contact to the OFF state before time out.

Timing Diagrams/Schematics

GT3F-1 Timing Diagrams

GT3F-1 (8-pin)	GT3F-1E (11-pin)
Delayed SPDT Output, with Reset Input	

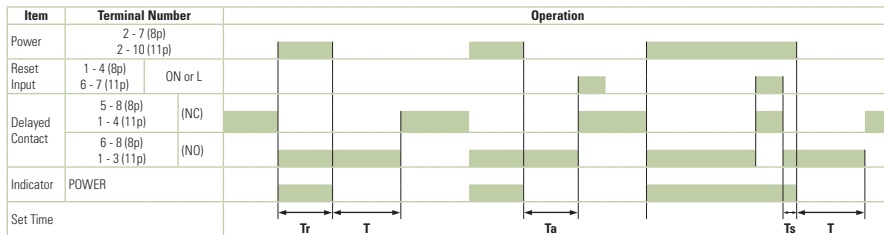
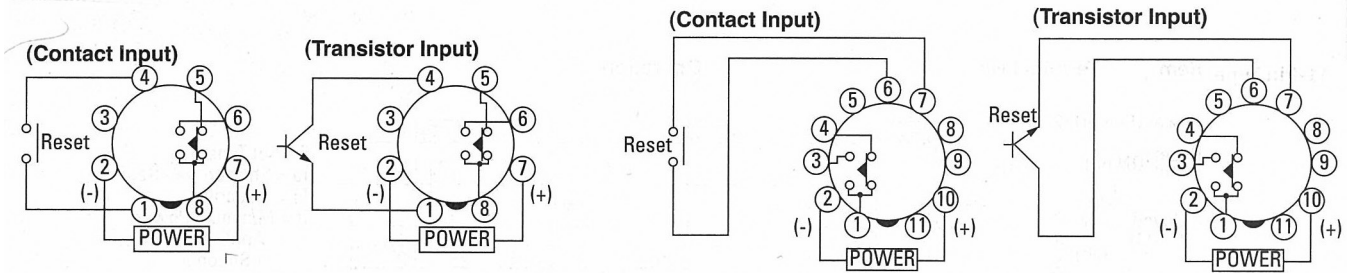

 T = Set time  
 Ta = Shorter than set time  
 Ts = 1 Second  
 Tr = Minimum Power Application Time  
 GT3F-1: 1 Second

1. For time ranges, see page page 941.
2. For sockets and accessory part numbers, see page page 967.
3. When power is applied, the NO output contact closes. When power is removed, the timing period begins. When time has elapsed, the NO contact opens.
4. For the timing diagram overview, see page page 940.

GT3F-2 Timing Diagrams

GT3F-2 (8-pin)	GT3F-2E (11-pin)
----------------	------------------

Delayed DPDT Output

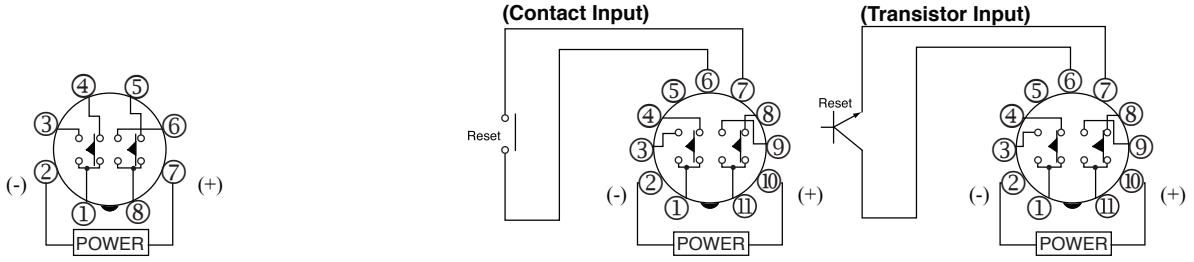

8-Pin Type

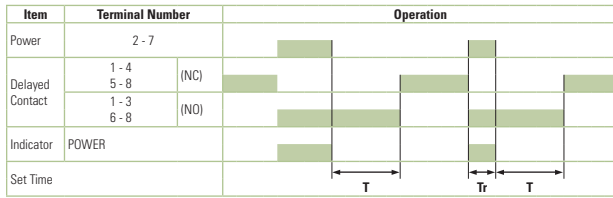

11-Pin Type

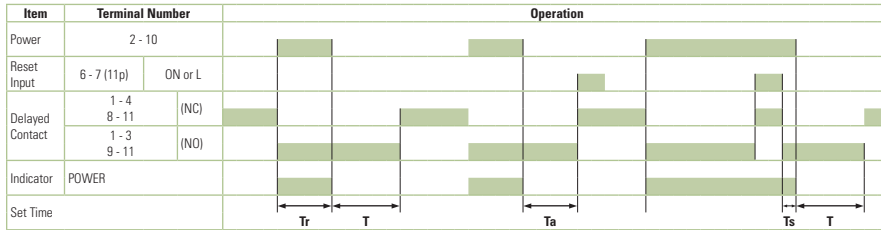

When power is applied, the NO contact closes. When power is removed, the timing period begins. When time has elapsed, the NO contact opens. Optional reset input will return contacts to original state before time elapses.

- T = Set time
- Ta = Shorter than set time
- Ts = 1 Second
- Tr = Minimum Power Application Time
- GT3F-1: 1 Second

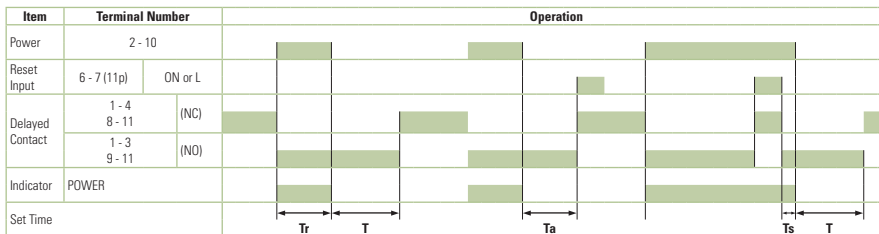

Switches & Pilot Lights

Signaling Lights

Relays & Sockets

Timers

Contactors

Terminal Blocks

Circuit Breakers

Instructions: Setting GT3F Series Timers



Step 1	Desired Operation	Selection		Remarks
Select a time range that contains the desired period of time.	Base Time Ranges	① Dial Selector	② Time Range Selector	Time range can be selected from 1S and 10S using a flat screwdriver and five different dials of 0 to 1, 0 to 3, 0 to 6, 0 to 18, and 0 to 60 are displayed in the six windows by turning the Dial Selector, allowing for selecting the best suited scale. Note that the switch does not turn infinitely.
	0.1s to 1s	0 to 1	1s	
	0.1s to 3s	0 to 3		
	0.1s to 6s	0 to 6		
	0.1s to 10s	0 to 1		
	0.3s to 30	0 to 3	10s	
	0.6s to 60	0 to 6		
	1.8s to 180s	0 to 18		
6s to 600s	0 to 60			
Step 2				Remarks
The set time is selected by turning the ③ Setting Knob.				Setting Examples: 1. When the Setting Knob ③ is set at 2.5, with Dial Selector ① 0 to 3 and Time Range Selector ② 1S selected, then the set time is 2.5 seconds. 2. When the Setting Knob ③ is set at 5.0, with Dial Selector ① 0 to 60 and Time Range Selector ② 10S selected, then the set time is 500 seconds.

Instructions: Wiring Inputs

Inputs of GT3F

To avoid electric shock, do not touch the input signal terminal during power voltage application. Never apply the input signals to two or more GT3F timers using the same contact or transistor.

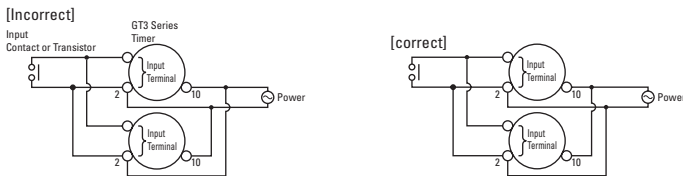

In a transistor circuit for controlling input signals, with its primary and secondary power circuits isolated, do not ground the secondary circuit.

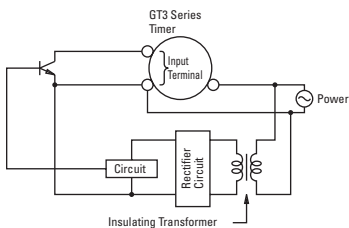

On the GT3F timers, connect the input signals to terminal No.1 and 4 only on the 8-pin type; connect the input signals to terminal No. 6 and 7 only on the 11-pin type. Never apply voltage to other terminals; otherwise, the internal circuit may be damaged. Input signal lines must be made as short as possible and installed away from power cables and power lines. Use shielded wires or a separate conduit for input wiring. The GT3F, consisting of a high-impedance circuit, may not be reset due to the influence of an inductive voltage or residual voltage caused by a leakage current. If not reset, connect an RC filter or bleeder resistor between power terminals so that the voltage between power terminals can be reduced to less than 15% of the rated voltage.

## GT3W Series – Dual Time Range Timers

## Key features:

- Sequential start, sequential interval, on-delay, recycler, and interval ON timing functions
- 2 time settings in one timer
- 8 selectable operation modes on each model
- Mountable in sockets or flush panel
- Power and output status indicating LEDs
- Time ranges up to 300 hours



## General Specifications

Operation System	Solid state CMOS Circuit	
Operation Type	Multi-Mode	
Time Range	1: 0.1sec to 6 hours, 3: 0.1sec to 300 hours	
Pollution Degree	2 (IE60664-1)	
Over Voltage Category	III (IE60664-1)	
Rated Operational Voltage	AF20	100-240V AC(50/60Hz)
	AD24	24V AC(50/60Hz)/24V DC
	D12	12V DC
Voltage Tolerance	AF20	85-264V AC(50/60Hz)
	AD24	20.4-26.4V AC(50/60Hz)/21.6-26.4V DC
	D12	10.8-13.2V DC
Disengaging Value of Input Voltage	Rated Voltage x10% minimum	
Range of Ambient Operating Temperature	-10 to +50°C (without freezing)	
Range of Ambient Storage and Transport Temperature	-30 to +75°C (without freezing)	
Range of Relative Humidity	35 to 85%RH (without condensation)	
Atmospheric Pressure	80kPa to 110kPa (Operating), 70kPa to 110kPa (Transport)	
Reset Time	60msec maximum	
Repeat Error	±0.2%, ±10msec*	
Voltage Error	±0.2%, ±10msec*	
Temperature Error	±0.6%, ±10msec*	
Setting Error	±10% maximum	
Insulation Resistance	100MΩ minimum (500V DC)	
Dielectric Strength	Between power and output terminals: 2000V AC, 1 minute Between contacts of different poles: 2000V AC, 1 minute Between contacts of the same pole: 750V AC, 1 minute	
Vibration Resistance	10 to 55Hz amplitude 0.75mm <sup>2</sup> hours in each of 3 axes	
Shock Resistance	Operating extremes: 98m/sec <sup>2</sup> (approx. 10G) Damage limits: 490m/sec <sup>2</sup> (approx. 50G) 3 times in each of 3 axes	
Degree of Protection	IP40 (enclosure), IP20 (socket) (IEC60529)	
Power Consumption (Approx.)	AF20	100V AC/60Hz
		200V AC/60Hz
	AD24 (AC/DC)	
Mounting Position	Free	
Dimensions	40Hx 36W x 70 mm	
Weight (Approx.)	72g	



\* For the value of the error against a preset time, whichever the largest applies.

## Contact Ratings

Allowable Contact Power	960VA/120W	
Allowable Voltage	250V AC/150V DC	
Allowable Current	5A	
Maximum permissible operating frequency	1800 cycles per hour	
	1/8HP, 240V AC	
Rated Load	3A, 240V AC (Resistive)	
	5A, 120V AC/30V DC (Resistive)	
	Fuse 5A, 250V	
Life	Electrical	100,000 op. minimum (Resistive)
	Mechanical	20,000,000 op. minimum

## Part Number List

## Part Numbers

Mode of Operation	Output	Contact	Time Range*	Rated Voltage	Pin Configuration	New Part Numbers	
A: Sequential Start B: On-delay with course and fine C: Recycler and instaneous D: Recycler outputs (OFF Start) E: Recycler outputs (ON Start) F: Interval ON G: Interval ON Delay H: Sequential Interval	3A, 240V AC	Delayed SPDT + Delayed SPDT	1: 0.1sec - 6 hours *(See Time Range Settings for details.)	100 to 240V AC (50/60Hz)	8 pin	GT3W-A11AF20N	
					11 pin	GT3W-A11EAF20N	
	5A, 120V AC/30V DC (Resistive Load)			24V AC/DC	8 pin	GT3W-A11AD24N	
					11 pin	GT3W-A11EAD24N	
				12V DC	8 pin	GT3W-A11D12N	
					11 pin	GT3W-A11ED12N	
			100 to 240V AC (50/60Hz)	8 pin	GT3W-A33AF20N		
			24V AC/DC		GT3W-A33AD24N		
				3: 0.1sec - 300 hours			



1. For timing diagrams and schematics, see page 940.
2. For socket and accessory part number information, see page 959.
3. 8- and 11-pin models differ only in the number of pins (extra pins are not used).
4. For the timing diagram overview, see page 940.
5. \*For details on setting time ranges, see the instructions on page 941.

## Time Range Table

Time Range Code: 1			Time Range Code: 3		
Time Range Selector	Scale	Time Range	Time Range Selector	Scale	Time Range
1S	0-1	0.1 sec - 1 sec	1S	0 - 3	0.1 sec - 3 sec
10S		0.3 sec - 10 sec	1M		3 sec - 3 min
10M		15 sec - 10 min	1H		3 min - 3 hours
1S	0 - 6	0.1 sec - 6 sec	1S	0 - 30	0.6 sec - 30 sec
10S		1 sec - 60 sec	1M		36 sec - 30 min
1M		6 sec - 6 min	1H		36min - 30 hours
10M		1 min - 60 min	10H		6 hours - 300 hours
1H		6 min - 6 hours			

Timing Diagrams/Schematics

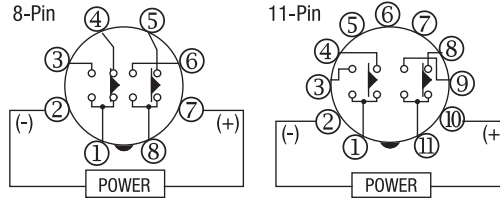

Mode	Operation Chart				Mode	Operation Chart			
A: Sequential Start	Item	Terminal No.	Operation	Description	E: Recycler outputs (ON Start)	Item	Terminal No.	Operation	Description
	Power	2-7	[ON]			Power	2-7	[ON]	
B: On-delay with course and fine	Item	Terminal No.	Operation	Description	F: Interval ON	Item	Terminal No.	Operation	Description
	Delayed Contact Ry1	1-4 (NC) 1-3 (NO)	[ON after T1 + T2]	ON after T1 + T2		Delayed Contact Ry1	1-4 (NC) 1-3 (NO)	[ON during T1]	ON during T1
C: Recycler and instantaneous	Item	Terminal No.	Operation	Description	G: Interval ON Delay	Item	Terminal No.	Operation	Description
	Delayed Contact Ry1	1-4 (NC) 1-3 (NO)	[Instantaneous ON]	Instantaneous ON		Delayed Contact Ry1	1-4 (NC) 1-3 (NO)	[ON during T1]	ON during T1
D: Recycler outputs (OFF Start)	Item	Terminal No.	Operation	Description	H: Sequential Interval	Item	Terminal No.	Operation	Description
	Delayed Contact Ry1	1-4 (NC) 1-3 (NO)	[OFF during T1 ON during T2]	OFF during T1 ON during T2		Delayed Contact Ry1	1-4 (NC) 1-3 (NO)	[ON during T1 + T2]	ON during T1 + T2

Switches & Pilot Lights

Signaling Lights

Relays & Sockets

Timers

Contactors

Terminal Blocks

Circuit Breakers

## Instructions: Setting GT3W Timer

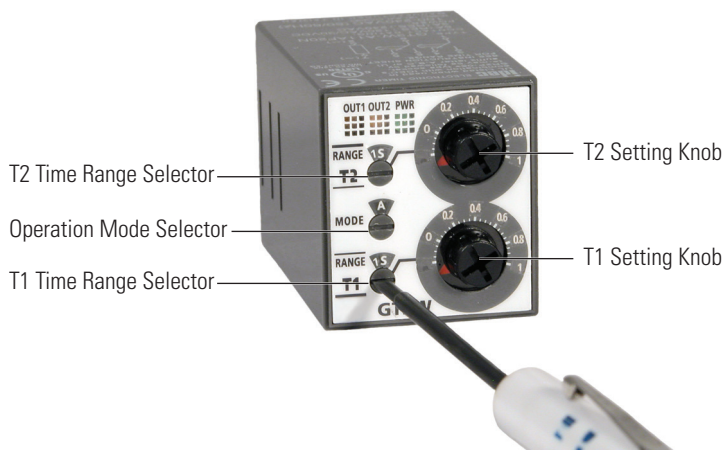

1. The switches should be securely turned using a flat screwdriver 4mm wide (maximum). Note that incorrect setting may cause malfunction. The switches, which do not turn infinitely, should not be turned beyond their limits.
2. Since changing the setting during timer operation may cause malfunction, turn power off before changing.

## Safety Precautions

## Caution

Caution notices are used where inattention might cause personal injury or damage to equipment.

- The Electronic Timer is designed for installation in equipment. Do not install the Electronic Timer outside equipment.
- Install the Electronic Timer in environments described in the specifications. If the Electronic Timer is used in places where it will be subjected to high-temperature, high-humidity, condensation, corrosive gases, excessive vibrations, or excessive shocks, then electrical shocks, fire hazard, or malfunction could result.
- Use an IEC60127-approved fuse and circuit breaker on the power and output line outside the Electronic Timer.
- Do not disassemble, repair, or modify the Electronic Timer.
- When disposing of the Electronic Timer, do so as industrial waste.

Special expertise is required to use Electronic Timers.

- All Electronic Timer modules are manufactured under IDEC's rigorous quality control system, but users must add a backup or fail safe provision to the control system when using the Electronic Timer in applications where heavy damage or personal injury may occur should the Electronic Timer fail.
- Install the Electronic Timer according to instructions described in this catalog.
- Make sure that the operating conditions are as described in the specifications. If you are uncertain about the specifications, contact IDEC in advance.
- In these directions, safety precautions are categorized in order of importance to Warning and Caution.

## Warning

Warning notices are used to emphasize that improper operation may cause severe personal injury or death.

- Turn power off to the Electronic timer before starting installation, removal, Wiring, maintenance, and inspection on the Electronic Timer.
- Failure to turn power off may cause electrical shocks or fire hazard.
- Emergency stop and interlocking circuits must be configured outside the Electronic timer. If such a circuit is configured inside the Electronic Timer, failure of the Electronic timer may cause malfunction of the control system, or an accident.



**GT3 Series  
Accessories**

**DIN Rail Mounting Accessories**

**DIN Rail/Surface Mount Sockets and Hold-Down Springs**

DIN Rail Mount Socket				Applicable Hold-Down Springs	
Style	Appearance	Use with Timers	Part No.	Appearance	Part No.
8-Pin Screw Terminal (dual tier)		GT3A-1, 2, 3 (8-pin) GT3F-1, 2 (8-pin) GT3W (8-pin)	SR2P-05		SFA-203
11-Pin Screw Terminal (dual tier)		GT3A-1, 2, 3 (11-pin) GT3A-4, 5, 6 GT3F-1, 2 (11-pin) GT3W (11-pin)	SR3P-05		
8-Pin Fingersafe Socket		GT3A-1, 2, 3 (8-pin) GT3F-1, 2 (8-pin) GT3W (8-pin)	SR2P-05C		
11-Pin Fingersafe Socket		GT3A-1, 2, 3 (11-pin) GT3A-4, 5, 6 GT3F-1, 2 (11-pin) GT3W (11-pin)	SR3P-05C		
8-Pin Screw Terminal		GT3A-1, 2, 3 (8-pin) GT3F-1, 2 (8-pin) GT3W (8-pin)	SR2P-06		SFA-202
11-Pin Screw Terminal		GT3A-1, 2, 3 (11-pin) GT3A-4, 5, 6 GT3F-1, 2 (11-pin) GT3W (11-pin)	SR3P-06		
DIN Mounting Rail Length 1000mm		—	BNDN1000		

**Installation of Hold-Down Springs**

**DIN Rail Mount Socket**

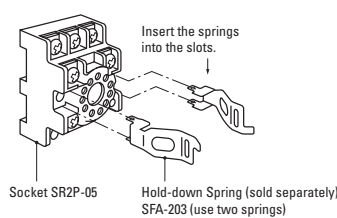
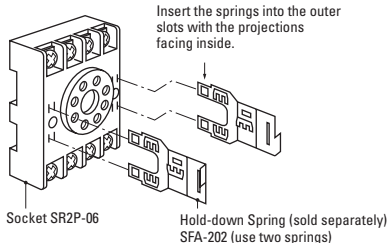

**Panel Mount Socket**

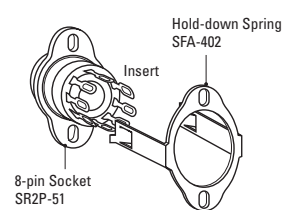

Switches & Pilot Lights

Signaling Lights

Relays & Sockets

Timers



Contactors

Terminal Blocks

Circuit Breakers





Panel Mounting Accessories

Panel Mount Sockets and Hold-Down Springs

Panel Mount Socket				Applicable HD Springs	
Style	Appearance	Use with Timers	Part No.	Appearance	Part No.
8-Pin Solder Terminal		GT3A- (8-pin) GT3W- (8-pin) GT3F- (8-pin)	SR2P-51		SFA-402
11-Pin Solder Terminal		GT3A- (11-pin) GT3W- (11-pin) GT3F- (11-pin)	SR3P-51		

 For information on installing the hold-down springs, see page 967.

Flush Panel Mount Adapter and Sockets that use an Adapter

Accessory	Description	Appearance	Use with Timers	Part No.
Panel Mount Adapter	Adaptor for flush panel mounting GT3 timers		All GT3 timers	RTB-G01
Sockets for use with Panel Mount Adapter	8-pin screw terminal	 (Shown: SR6P-M08G for Wiring Socket Adapter)	All 8-pin timers	SR6P-M08G
	11-pin screw terminal		All 11-pin timers	SR6P-M11G
	8-pin solder terminal		All 8-pin timers	SR6P-S08
	11-pin solder terminal		All 11-pin timers	SR6P-S11

 No hold down springs are available for flush panel mounting.

Switches & Pilot Lights

Signaling Lights

Relays & Sockets

Timers

Contactors

Terminal Blocks

Circuit Breakers

Instructions: Wiring Inputs for GT3 Series

Inputs

To avoid electric shock, do not touch the input signal terminal during power voltage application.

When connecting the input signal terminals of two or more GT3A timers to the same contact or transistor, the input terminals of the same number should be connected. (Connect Terminals No.2 in common.)

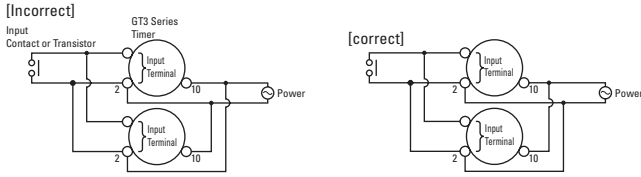

In a transistor circuit for controlling input signals, with its primary and secondary power circuits isolated, do not ground the secondary circuit.

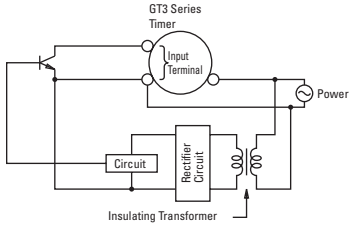

Connect the input signal terminals of the GT3A timers to Terminal No.2 only. Never apply voltage to other terminals; otherwise, the internal circuit may be damaged.

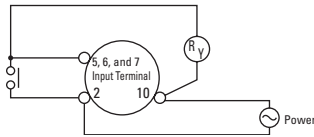

Input signal lines must be made as short as possible and installed away from power cables and power lines. Use shielded wires or a separate conduit for input wiring.

Switches & Pilot Lights

Signaling Lights

Relays & Sockets

Timers

Contactors

Terminal Blocks

Circuit Breakers

Inputs Instructions, continued

For contact input, use gold-plated contacts to make sure that the residual voltage is less than 1V when the contacts are closed.

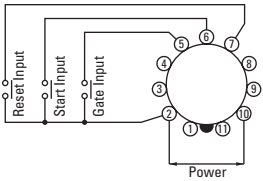

For transistor input, use transistors with the following specifications; VCE = 40V, VCES = 1V or less, IC = 50 mA or more, and ICBO = 50μA or less. The resistance should be less than 1kΩ when the transistor is on. When the output transistor switches on, a signal is input to the timer.

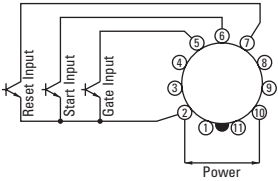

Inputs: GT3A-1, -2, -3

Transistor output equipment such as proximity switches and photoelectric switches can input signals if they are voltage/current output type, with power voltage ranges from 18 to 30V and have 1V. When the signal voltage switches from H to L, a signal is input to the timer

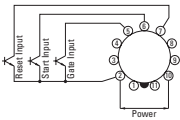

Inputs: GT3A-4, -5, -6

<b>Start Input</b>	The start input initiates a time-delay operation and controls output status.	No-voltage contact inputs and NPN open collector transistor inputs are applicable.
<b>Reset Input</b>	When the reset input is activated, the time is reset, and contacts return to original state.	24V DC, 1mA maximum
<b>Gate Input</b>	The time-delay operation is suspended while the gate input is on (pause).	Input response time: 50msec maximum

Switches & Pilot Lights

Signaling Lights

Relays & Sockets

Timers

Contactors

Terminal Blocks

Circuit Breakers

Dimensions

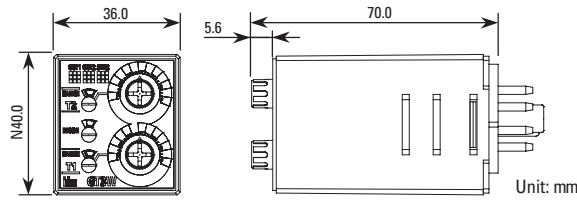

NOTE: GT3W series are UL Listed when used in combination with following IDEC's sockets:  
 GT3W-A11, A33: SR2P-06\* pin type socket.  
 GT3W-A11E: SR3P-05\* pin type socket.  
 (\*-May be followed by A,B,C or U)  
 The socket to be used with these timers are rated:  
 -Conductor Temperature Rating 60°C min.  
 -Use 14AWG max.(2mm<sup>2</sup>max.) Copper conductors only  
 -Terminal Torque 1.0 to 1.3 N-m

Analog GT3 Timer, 8-Pin with SR2P-06

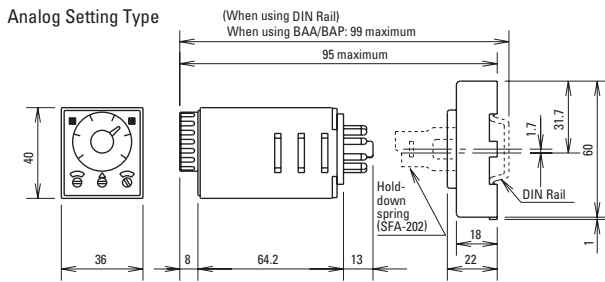

Analog GT3 Timer, 11-Pin with SR3P-06

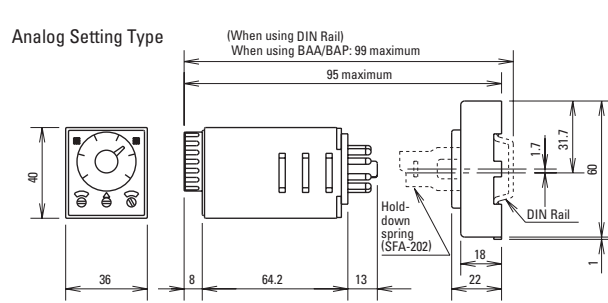

Analog GT3 Timer, 11-Pin with SR3P-05

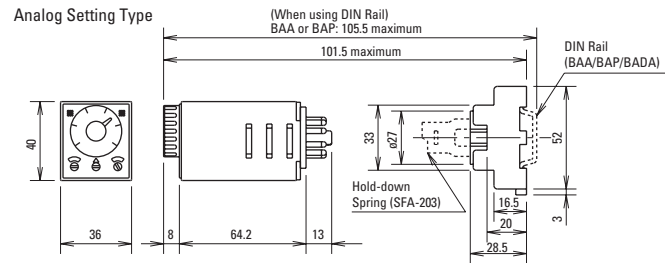

Panel Mount Adapter

Analog GT3 Timer, 8-Pin and 11-Pin with SR6P-S08 or SR6P-S11

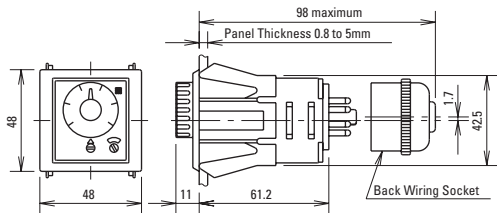

Switches & Pilot Lights

Signaling Lights

Relays & Sockets

Timers

Contactors

Terminal Blocks

Circuit Breakers

Switches & Pilot Lights

Signaling Lights

Relays & Sockets

Timers

Contactors

Terminal Blocks

Circuit Breakers

### Mounting Hole Layout

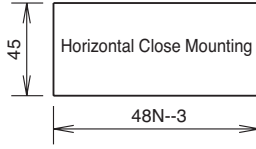
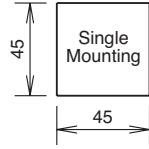

Tolerance: +0.5 to 0  
N: No. of timers mounted

GT3 Timer, 8-Pin with SR6P-M08G

GT3 Timer, 11-Pin with SR6P-M11G

