

10 9 8 7 6 5 4 3 2 1

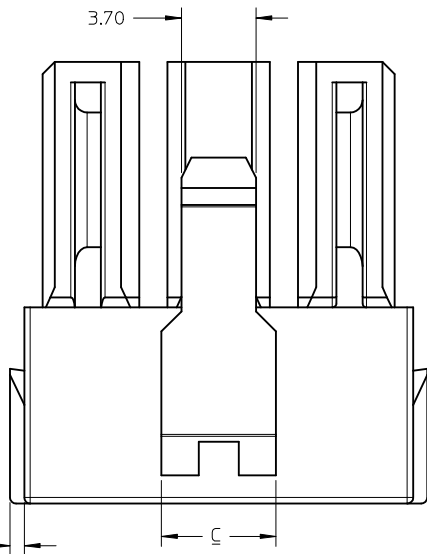
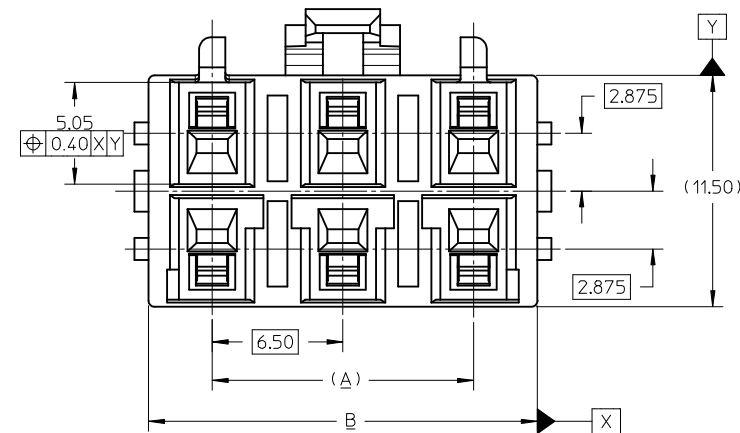
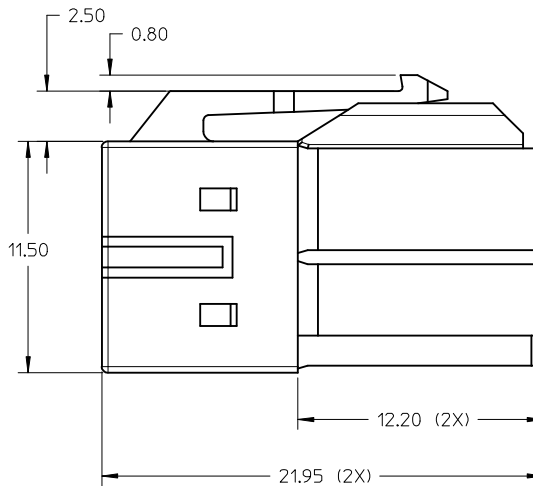
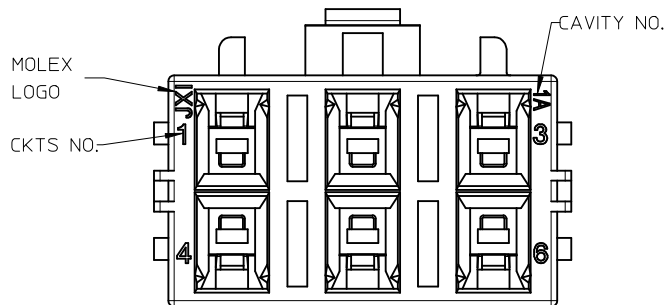

PART NO. LEGEND

151049 - * * * *

- * COLOR
- * CKT NO.
- * OTHERS

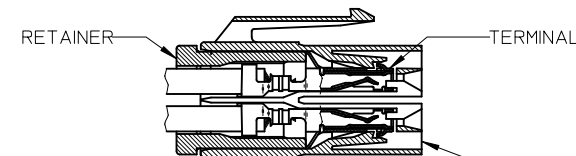

TERMINAL AND RETAINER ASSEMBLY DRAWING

NOTES:

1. MATERIAL: HOUSING: PBTP, UL94V-0
2. APPLICATION TERMINAL :
50597 (FOR WIRE RANGE #16~#22)
50598 (FOR WIRE RANGE #20~#26)
3. APPLICATION RETAINER : 51143
4. REFER TO COSMETIC SPECIFICATION: PS-45499-002(CLASS B)
5. MATE WITH HEADER 151048 SERIES
6. PRODUCT SPECIFICATION: PS-151048-0001
7. PACKAGING SPECIFICATION: PK-151049-0001

6	13.00	19.34	5.70	REFER TO PG 4
4	6.50	12.84	3.70	REFER TO PG 3
2	-	6.34	5.70	REFER TO PG 2
CKT. NO.	A	B	C	MATERIAL NO.

UPDATE DRAWING EC NO: S2015-1136 DRW:NEANG 2015/07/10 CHKD:CGOH 2015/07/21 APPR:KHLIM 2015/07/22	DESCRIPTION
	QUALITY SYMBOLS
	$F_A=0$ $F_C=0$ $F_P=0$
	GENERAL TOLERANCES (UNLESS SPECIFIED)
	DIMENSION STYLE MM ONLY
	SCALE NTS

	GENERAL TOLERANCES (UNLESS SPECIFIED)	
	mm	INCH
4 PLACES	± ---	± ---
3 PLACES	± ---	± ---
2 PLACES	± 0.20	± ---
1 PLACE	± ---	± ---
0 PLACE	± ---	± ---
ANGULAR ± 3 °		
DRAFT WHERE APPLICABLE MUST REMAIN WITHIN DIMENSIONS		

DESIGN UNITS METRIC	THIRD ANGLE PROJECTION
DRAWN BY EANG	DATE 2014/03/13
CHECKED BY CGOH	DATE 2015/03/12
APPROVED BY KHLIM	DATE 2015/03/16
MATERIAL NO.	SEE TABLE

SALES DRAWING
6.5 RECEPTACLE HOUSING
WIRE TO BOARD CONNECTOR

DOCUMENT NO. **SD-151049-0001**

SHEET NO. **1 OF 4**

THIS DRAWING CONTAINS INFORMATION THAT IS PROPRIETARY TO MOLEX INCORPORATED AND SHOULD NOT BE USED WITHOUT WRITTEN PERMISSION

9 8 7 6 5 4 3 2 1

HOUSING WITH POLARIZATION FEATURES AND COLOR FOR 2CKTS

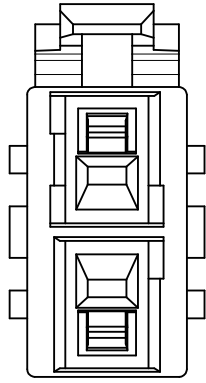

① 1510492200
ORANGE

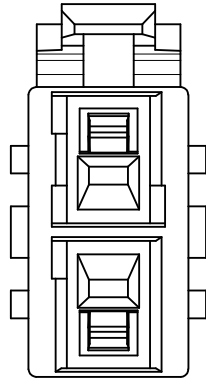

② 1510492201
BLUE

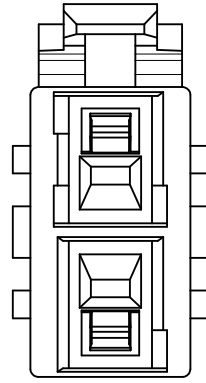

③ 1510492202
GREY

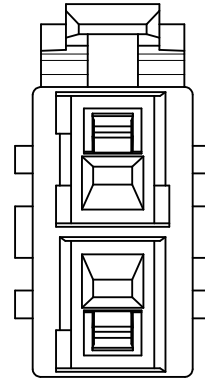

④ 1510492203
YELLOW

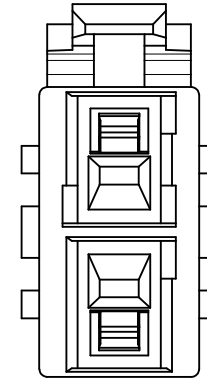

⑤ 1510492204
PURPLE

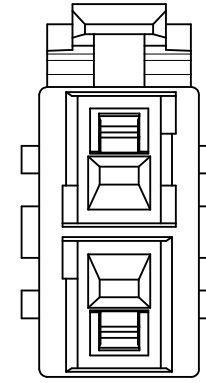

⑥ 1510492205
PINK

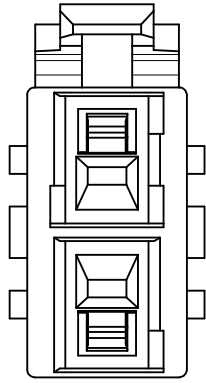

⑦ 1510492206
BLACK

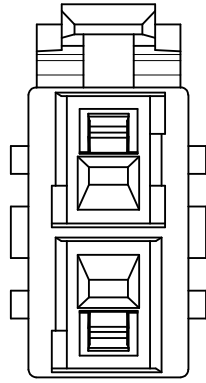

⑧ 1510492207
GREEN

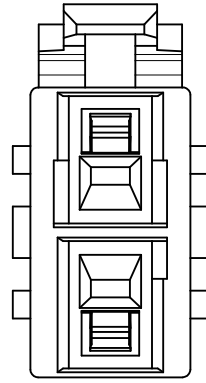

⑨ 1510492208
BROWN

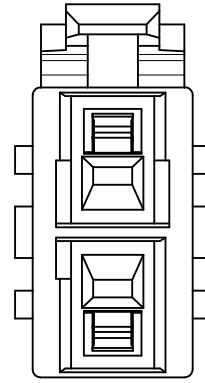

⑩ 1510492209
RED

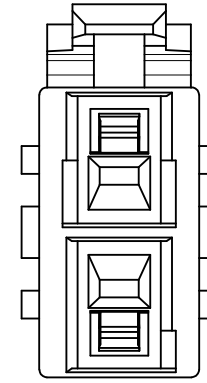

⑪ 1510492210
MINT

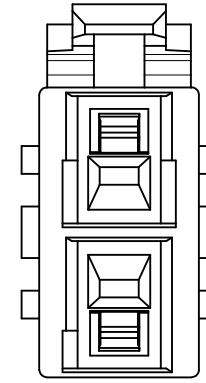

⑫ 1510492211
NATURAL (WHITE)

1	1510492200	ORANGE	*	
2	1510492201	BLUE	*	
3	1510492202	GREY		*
4	1510492203	YELLOW	*	
5	1510492204	PURPLE		*
6	1510492205	PINK		*
7	1510492206	BLACK	*	
8	1510492207	GREEN		*
9	1510492208	BROWN		*
10	1510492209	RED	*	
11	1510492210	MINT		*
12	1510492211	NATURAL (WHITE)	*	
CONFIGURATION	ASSEMBLY	COLOR	STANDARD COLOR	CUSTOM COLOR

UPDATE DRAWING EC NO: S2015-1136 DRW:NEANG 2015/07/10 CHKD:CGOH 2015/07/21 APPR:KHLIM 2015/07/22	QUALITY SYMBOLS
	$F_A=0$ $F_G=0$ $F_P=0$
	DESCRIPTION
	REV

GENERAL TOLERANCES (UNLESS SPECIFIED)	DIMENSION STYLE
	MM ONLY
	SCALE NTS
	DESIGN UNITS METRIC
	THIRD ANGLE PROJECTION
	DRAWN BY DATE
	EANG 2014/03/13
	CHECKED BY DATE
	CGOH 2015/03/12
	APPROVED BY DATE
	KHLIM 2015/03/16
	MATERIAL NO.
	SEE TABLE
	SIZE A3
	THIS DRAWING CONTAINS INFORMATION THAT IS PROPRIETARY TO MOLEX INCORPORATED AND SHOULD NOT BE USED WITHOUT WRITTEN PERMISSION

4 PLACES	± ---	± ---
3 PLACES	± ---	± ---
2 PLACES	± 0.20	± ---
1 PLACE	± ---	± ---
0 PLACE	± ---	± ---
ANGULAR ± 3 °		
DRAFT WHERE APPLICABLE MUST REMAIN WITHIN DIMENSIONS		

TITLE		SALES DRAWING	
TITLE		6.5 RECEPTACLE HOUSING	
TITLE		WIRE TO BOARD CONNECTOR	
TITLE		molex	
DOCUMENT NO.	SD-151049-0001	SHEET NO.	2 OF 4

10 9 8 7 6 5 4 3 2 1

HOUSING WITH POLARIZATION FEATURES AND COLOR FOR 4CKTS

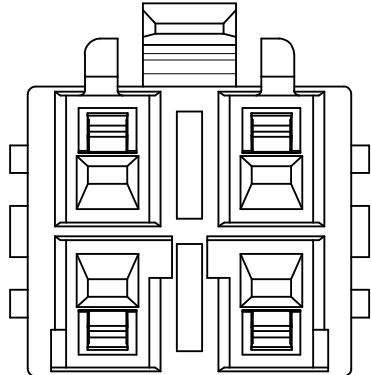

① 1510492401
BLUE

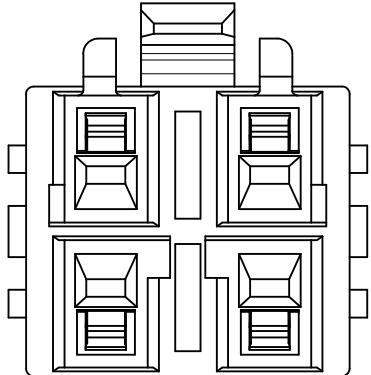

② 1510492406
BLACK

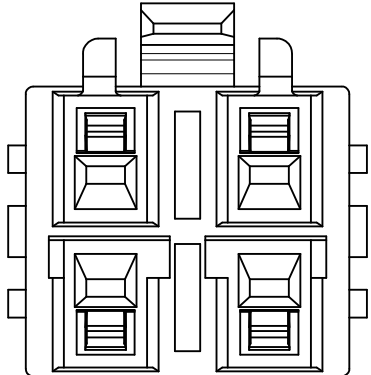

③ 1510492411
NATURAL (WHITE)

1	1510492401	BLUE
2	1510492406	BLACK
3	1510492411	NATURAL (WHITE)
CONFIGURATION	ASSEMBLY	COLOR

UPDATE DRAWING	EC NO: S2015-1136
	DRW: EANG 2015/07/10
	CHKD: CGOH 2015/07/21
	APPR: KHL IM 2015/07/22
	REV 6

DESCRIPTION	QUALITY SYMBOLS
	$F_A=0$
	$F_C=0$
	$F_P=0$

GENERAL TOLERANCES (UNLESS SPECIFIED)	
	mm INCH
4 PLACES	± --- ± ---
3 PLACES	± --- ± ---
2 PLACES	± 0.20 ± ---
1 PLACE	± --- ± ---
0 PLACE	± --- ± ---
ANGULAR ± 3 °	
DRAFT WHERE APPLICABLE MUST REMAIN WITHIN DIMENSIONS	

DIMENSION STYLE	
MM ONLY	
DRAWN BY	DATE
EANG	2014/03/13
CHECKED BY	DATE
CGOH	2015/03/12
APPROVED BY	DATE
KHL IM	2015/03/16
MATERIAL NO.	
SEE TABLE	
SIZE	A3

SCALE	NTS	DESIGN UNITS	METRIC	THIRD ANGLE PROJECTION
TITLE				
SALES DRAWING 6.5 RECEPTACLE HOUSING WIRE TO BOARD CONNECTOR				
molex				SHEET NO.
DOCUMENT NO. SD-151049-0001				3 OF 4
THIS DRAWING CONTAINS INFORMATION THAT IS PROPRIETARY TO MOLEX INCORPORATED AND SHOULD NOT BE USED WITHOUT WRITTEN PERMISSION				

9 8 7 6 5 4 3 2 1

10 9 8 7 6 5 4 3 2 1

HOUSING WITH POLARIZATION FEATURES AND COLOR FOR 6CKTS

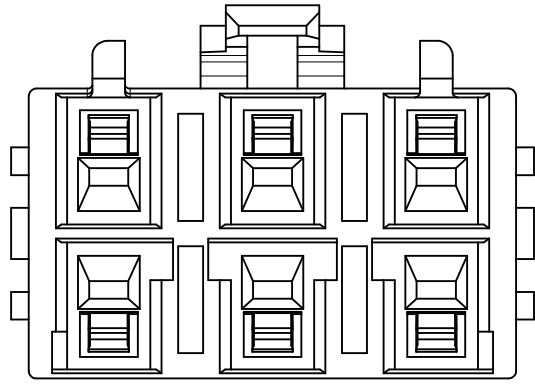

① 1510492601
BLUE

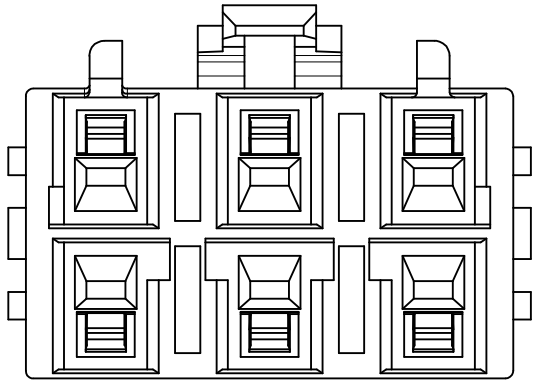

② 1510492606
BLACK

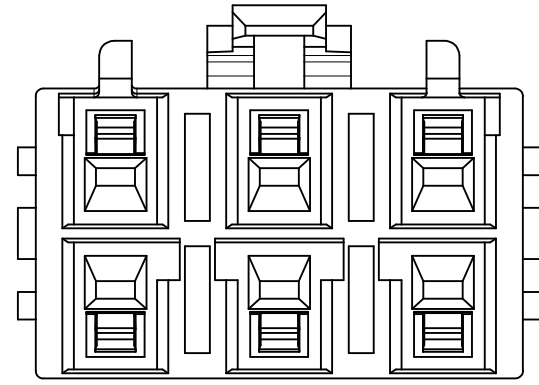

③ 1510492609
RED

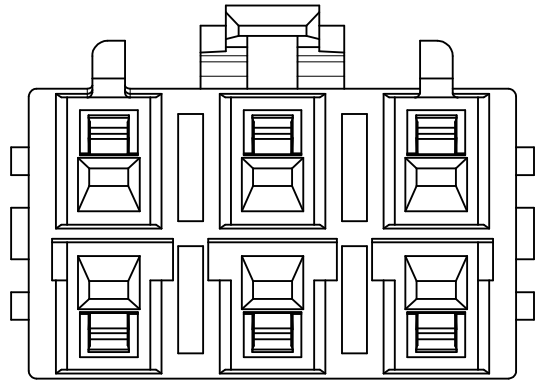

④ 1510492611
NATURAL (WHITE)

1	1510492601	BLUE
2	1510492606	BLACK
3	1510492609	RED
4	1510492611	NATURAL (WHITE)
CONFIGURATION	ASSEMBLY	COLOR

UPDATE DRAWING EC NO: S2015-1136 DRW: EANG 2015/07/10 CHKD: CGOH 2015/07/21 APPR: KHL IM 2015/07/22	QUALITY SYMBOLS	GENERAL TOLERANCES (UNLESS SPECIFIED)	DIMENSION STYLE MM ONLY	SCALE NTS	DESIGN UNITS METRIC	THIRD ANGLE PROJECTION
	$F_A=0$	4 PLACES ± --- ± ---	mm INCH	DRAWN BY EANG	DATE 2014/03/13	TITLE
	$F_G=0$	3 PLACES ± --- ± ---		CHECKED BY CGOH	DATE 2015/03/12	SALES DRAWING 6.5 RECEPTACLE HOUSING WIRE TO BOARD CONNECTOR molex
	$F_P=0$	2 PLACES ± 0.20 ± ---		APPROVED BY KHL IM	DATE 2015/03/16	
		1 PLACE ± --- ± ---	ANGULAR ± 3 °	MATERIAL NO.	DOCUMENT NO.	SHEET NO.
		0 PLACE ± --- ± ---	DRAFT WHERE APPLICABLE MUST REMAIN WITHIN DIMENSIONS	SEE TABLE	SD-151049-0001	4 OF 4
6	REV		SIZE A3	THIS DRAWING CONTAINS INFORMATION THAT IS PROPRIETARY TO MOLEX INCORPORATED AND SHOULD NOT BE USED WITHOUT WRITTEN PERMISSION		

9 8 7 6 5 4 3 2 1