

注記 NOTES

1. 使用材料 MATERIAL

ハウジング : 液晶ポリマー (LCP) UL94V-0 (黒)
 HOUSING: LIQUID CRYSTAL POLYMER UL94V-0 (COLOR: BLACK)
 ターミナル : 銅合金
 TERMINAL : COPPER ALLOY
 金具 : 銅合金
 FITTING NAIL : COPPER ALLOY

2. メッキ仕様 PLATING

ターミナル TERMINAL

金メッキ
 GOLD

下地メッキ : ニッケルメッキ
 UNDER PLATING : NICKEL

※コンタクト部とテール部の基板接触面には金メッキを施してあります。

それ以外の箇所は金メッキもしくはニッケルメッキが露出し、
 外観上 色調が異なる場合がありますが、性能には影響ありません。

但し、コンタクト部とテール部の間にはニッケルメッキで金メッキを分断している箇所があります。

CONTACT AREA : GOLD PLATING

SOLDER TAIL AREA (PWB CONTACT SURFACE SIDE ONLY) : GOLD PLATING

OTHER AREAS : GOLD PLATING OR NICKEL PLATING

NICKEL PLATING DIVIDES BETWEEN THE CONTACT AREA (GOLD PLATING)
 AND SOLDER TAIL AREA (GOLD PLATING).

金具 FITTING NAIL

金メッキ (テール部のみ)
 GOLD (ONLY TAIL PART)

下地メッキ : ニッケルメッキ
 UNDER PLATING : NICKEL

△ (全極数 / 2) = 偶数の場合に適用。
 APPLY FOR (CIRCUIT / 2) = EVEN.

4. 嵌合相手 : 503552 シリーズ
 MATE WITH : 503552 SERIES.

5. テール平坦度は、0.08 以下

テール及び金具の平坦度は、0.1 以下
 TAIL COPLANARITY TO BE 0.08 MAXIMUM.
 TAIL AND FITTING NAIL COPLANARITY TO BE 0.1 MAXIMUM.

6. ELV and RoHS COMPLIANT.

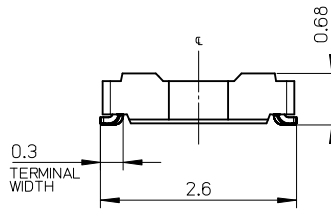
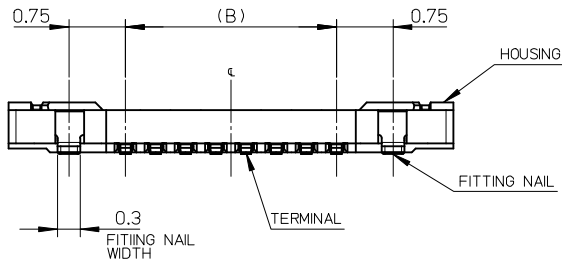
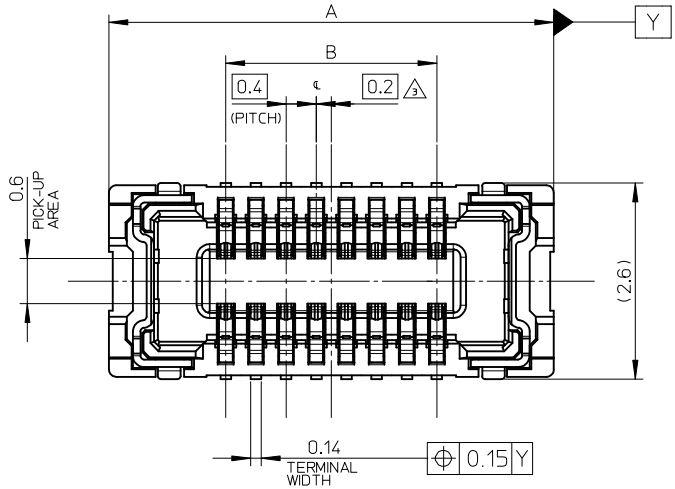

3.2	6.3	503548-1820	18
2.8	5.9	503548-1620	16
2.4	5.5	503548-1420	14
2.0	5.1	503548-1220	12
1.6	4.7	503548-1020	10
0.8	3.9	503548-0620	6
B	A	EMBOSSED PACKAGE	
		極数	CIRCUITS
		オーダー番号	ORDER No.
CONNECTOR SERIES No. : 503548-***19			

REVISED EC NO: J2013-1507 DRWN: YUJIMAKI 2013/06/13 CHKD: TASAKAWA 2013/06/13 APPR: MORIKAWA 2013/06/14	GENERAL TOLERANCES (UNLESS SPECIFIED)		DIMENSION STYLE MM ONLY		SCALE 15:1	DESIGN UNITS METRIC	THIRD ANGLE PROJECTION
	10 UNDER	± 0.2	DRAWN BY RTAKEUCHI	DATE 2010/05/17	TITLE 0.4 B-TO-B CONN. HGT=0.7 W=2.6 HI-RETENTION REC ASSY		
	10 OVER 30 UNDER	± 0.25	CHECKED BY T. HIRATA	DATE 2010/05/17			
	30 OVER	± 0.3	APPROVED BY MSASAO	DATE 2010/09/15			
	ANGULAR ±1 °	DRAFT WHERE APPLICABLE MUST REMAIN WITHIN DIMENSIONS	MATERIAL NO. SEE CHART		DOCUMENT NO. SD-503548-005	SHEET NO. 1 OF 2	
A	REV	THIS DRAWING CONTAINS INFORMATION THAT IS PROPRIETARY TO MOLEX INCORPORATED AND SHOULD NOT BE USED WITHOUT WRITTEN PERMISSION					

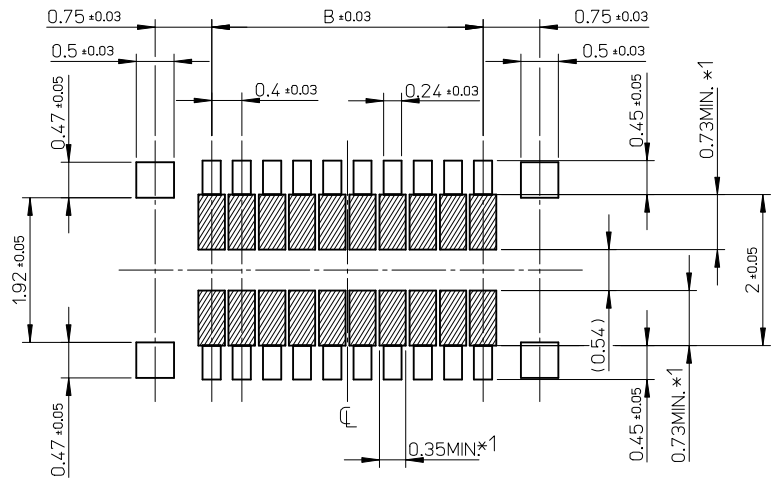

RECOMMENDED P.W. BOARD PATTERN LAYOUT

- *1 パターン引き回し、および半田禁止エリア
(当該箇所においては、これと接する回路以外の配線を禁止する。
また、接する回路を配線する場合はレジストを施し、この部分に半田は無きこととする。)
- *1 PROHIBITED AREA OF PATTERN WIRING AND SOLDER.
(FOR EACH AREA, THE WIRING THAT TOUCHES ON THE SOLDER CAN BE ATTACHED, THEN COVERED WITH A FILM TO KEEP SOLDER OUT.)

REVISED	EC NO: J2013-1507	GENERAL TOLERANCES (UNLESS SPECIFIED)		DIMENSION STYLE MM ONLY		SCALE 15:1	DESIGN UNITS METRIC	THIRD ANGLE PROJECTION	
	DRWN: YFUJIMAKI 2013/06/13	10 UNDER	± 0.2	DRAWN BY RTAKEUCHI	DATE 2010/05/17	TITLE 0.4 B-TO-B CONN. HGT=0.7 W=2.6 HI-RETENTION REC ASSY			
	CHKD: TASAKAWA 2013/06/13	10 OVER 30 UNDER	± 0.25	CHECKED BY T. HIRATA	DATE 2010/05/17				
	APPR: KMORIKAWA 2013/06/14	30 OVER	± 0.3	APPROVED BY MSASAO	DATE 2010/09/15	molex			
A	ANGULAR ±1 °	DRAFT WHERE APPLICABLE MUST REMAIN WITHIN DIMENSIONS		MATERIAL NO. SEE SHEET 1	DOCUMENT NO. SD-503548-005				
THIS DRAWING CONTAINS INFORMATION THAT IS PROPRIETARY TO MOLEX INCORPORATED AND SHOULD NOT BE USED WITHOUT WRITTEN PERMISSION									

注記 NOTES

- 製品詳細寸法については製品単体図面を参照下さい。
RE DETAILED DIMENSION, SEE PRODUCT DRAWING.
- 梱包数量: 3000 個/リール
NUMBER OF CONNECTORS: 3000PCS/REEL
- リードテープ長さ LEAD TAPE LENGTH

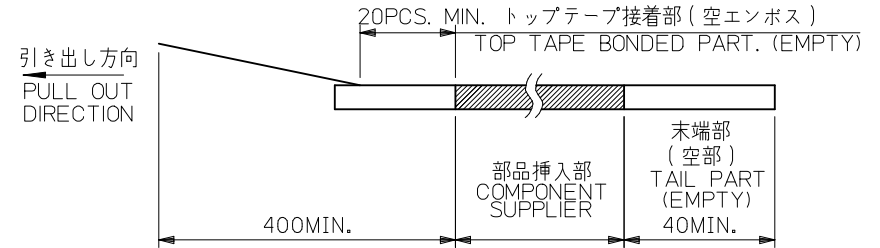
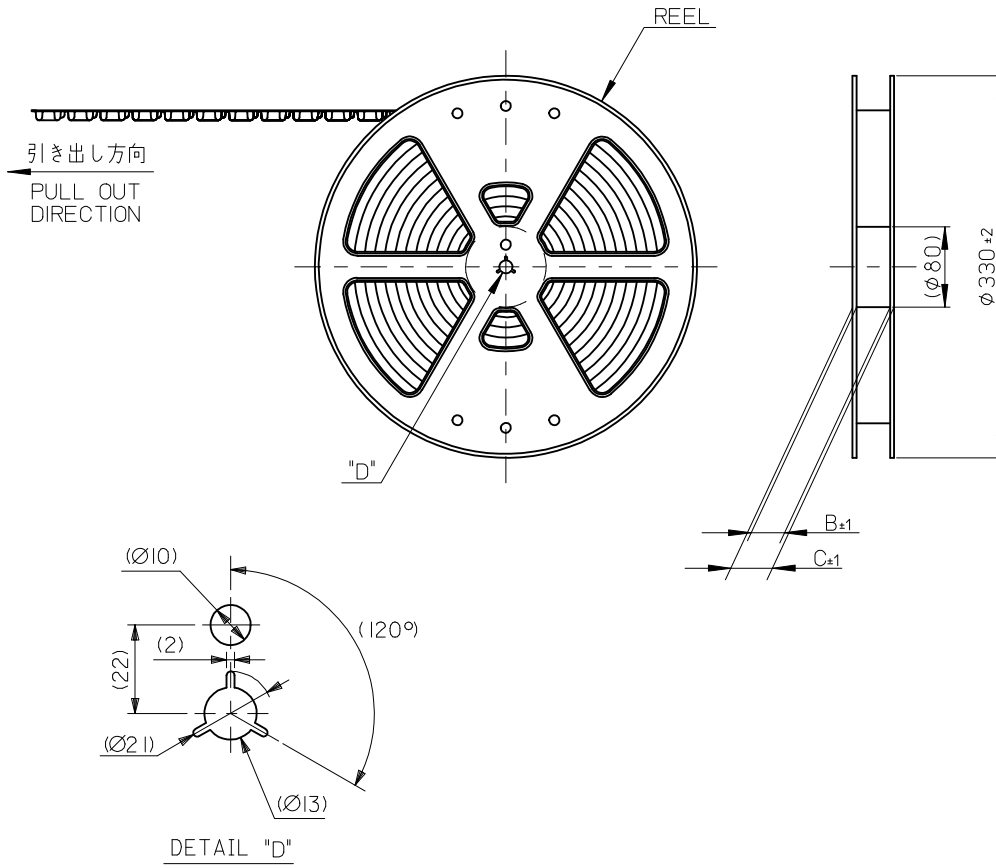

- トップテープの剥離強度: 0.1N~1.3N(10gf~130gf)
(剥離方向は下図参照)
尚、本規格値は出荷時に適用。(但し、輸送時に剥離が発生しないこと。)
PEELING OFF FORCE OF TOP TAPE: 0.1N~1.3N(10gf~130gf)
(PEELING DIRECTION AS SHOWN IN FOLLOWING FIG.)
THIS REQUIREMENT SHOULD BE APPLIED AT SHIPMENT.
PEEL OFF SHOULD NOT BE ALLOWED, DURING TRANSPORTION.

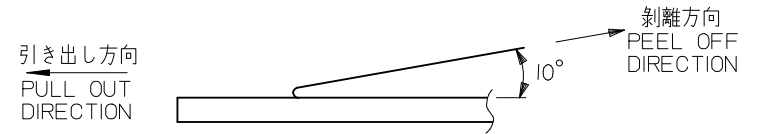

- 材料 MATERIAL
キャリアテープ (CARRIER TAPE): ポリスチレン (POLYSTYRENE)
トップテープ (TOP TAPE): PET, OTHER
リール (REEL): ポリスチレン (PS) <リサイクル材を含む>
POLYSTYRENE (PS) <RECYCLE MATERIAL CONTAINED>
- ELV 及び RoHS適合品
ELV AND RoHS COMPLIANT

REVISED EC NO: J2013-1507 DRWN: YFUJIMAKI 2013/06/13 CHKD: TASAKAWA 2013/06/13 APPR: KMORIKAWA 2013/06/14	DESCRIPTION GENERAL TOLERANCES (UNLESS SPECIFIED)	10 UNDER	±---	DIMENSION STYLE MM ONLY	SCALE 1:1	DESIGN UNITS METRIC	MODEL NO. 503548-**-20	
		10 OVER 30 UNDER	±---	DRAWN BY RTAKEUCHI	DATE 2010/02/08	TITLE 0.4 B-TO-B CONN. HGT=0.7 HI-RETENTION REC ASSY EMBSTP PKG	THIRD ANGLE PROJECTION	
		30 OVER	±---	CHECKED BY THIRATA	DATE 2010/02/08	molex		
		ANGULAR	±---	APPROVED BY MSASAO	DATE 2010/02/08			
A	DRAFT WHERE APPLICABLE MUST REMAIN WITHIN DIMENSIONS	MATERIAL NO. SEE SHEET 2	DOCUMENT NO. SD-503548-006	SHEET NO. 1 OF 2	THIS DRAWING CONTAINS INFORMATION THAT IS PROPRIETARY TO MOLEX INCORPORATED AND SHOULD NOT BE USED WITHOUT WRITTEN PERMISSION			

引き出し方向
PULL OUT DIRECTION

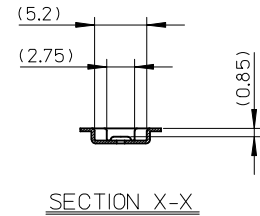
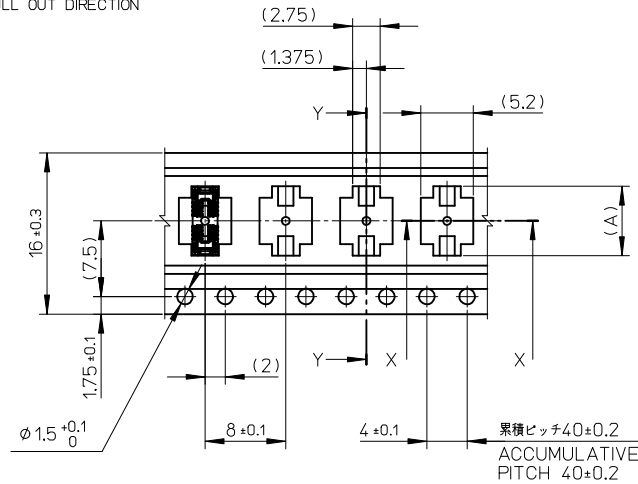
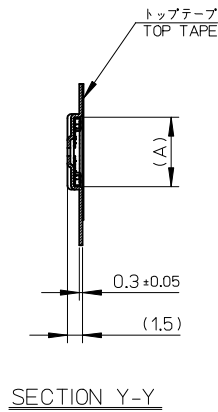

16mm 幅キャリアテープ
16mm WIDTH CARRIER TAPE

16	21.4	17.4	6.5	503548-1820	18
			6.1	503548-1620	16
			5.7	503548-1420	14
			5.3	503548-1220	12
			4.9	503548-1020	10
			4.1	503548-0620	6
キャリアテープ幅 CARRIER TAPE WIDTH			C	B	(A)
			MATERIAL No.		CKT.
			MODEL No.		503548-**20

REVISED EC NO: J2013-1507 DRWN:YFUJIMAKI 2013/06/13 CHKD:TASAKAWA 2013/06/13 APPR:KMORIKAWA 2013/06/14	DESCRIPTION REV	GENERAL TOLERANCES (UNLESS SPECIFIED)		DIMENSION STYLE MM ONLY		SCALE 1:1	DESIGN UNITS METRIC	THIRD ANGLE PROJECTION	
		10 UNDER	±---	DRAWN BY RTAKEUCHI	DATE 2010/02/08	TITLE 0.4 B-TO-B CONN. HGT=0.7 HI-RETENTION REC ASSY EMBSTP PKG			
		10 OVER 30 UNDER	±---	CHECKED BY THIRATA	DATE 2010/02/08				
		30 OVER	±---	APPROVED BY MSASAO	DATE 2010/02/08				
ANGULAR ±--- °		DRAFT WHERE APPLICABLE MUST REMAIN WITHIN DIMENSIONS		MATERIAL NO. SEE CHART		DOCUMENT NO. SD-503548-006		SHEET NO. 2 OF 2	
THIS DRAWING CONTAINS INFORMATION THAT IS PROPRIETARY TO MOLEX INCORPORATED AND SHOULD NOT BE USED WITHOUT WRITTEN PERMISSION									