

S Series Unsealed, SE Series Sealed, Through-Hole and Surface Mount

Product Facts

- Sealed or Unsealed
- Straight or Right-Angle
- Through-hole or Surface-mount
- Bulk or Tape-and-Reel packaged
- Compact size
- Double-pole function in a single-pole body
- PC retention feature
- High reliability contact system
- Epoxy sealed base
- Robust actuator for easy actuation
- Non-shorting (break-before-make)

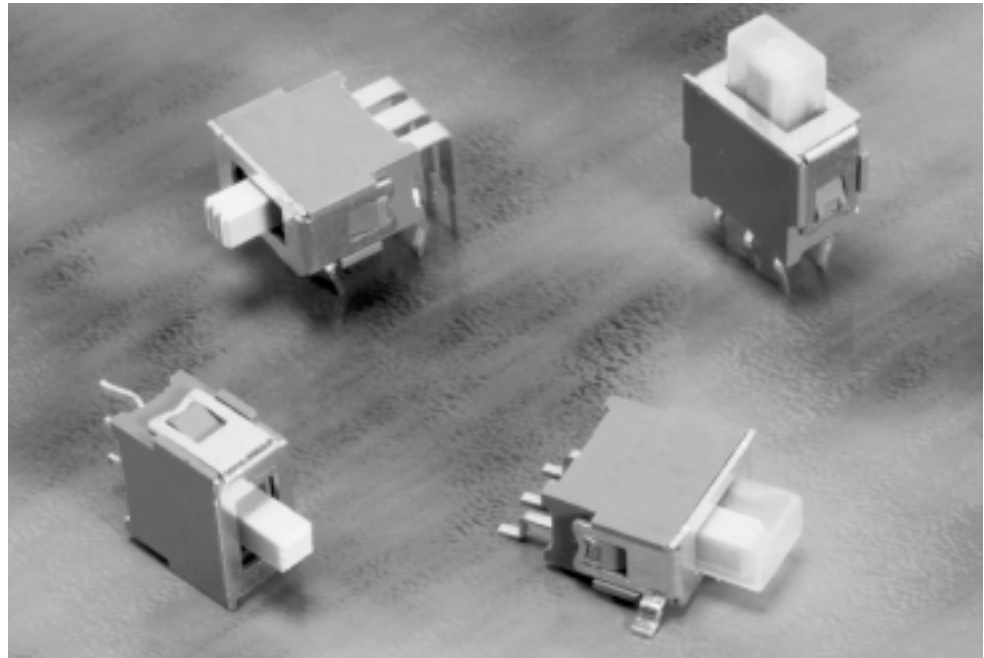

Switch, Slide, Surface Mount - SE1 SMT (Shown w/Boot)

Electrical Characteristics

Contact rating: .4 VA @ 20 VDC Max.
50mA 48V AC/DC
Min. 1 micro A 20 mV AC/DC

Initial Contact Resistance: less than 50 milliohms

Final Contact Resistance: 100 milliohms max.

Insulation Resistance: 500 Megaohms @ 250 VDC

Dielectric Strength: 500 VAC between terminals and ground

Mechanical

Mechanical Life: Up to 10,000 cycles @ max. load

Actuation Force: 70 to 500 grams

Materials and Finish

Terminals: Tin-lead over nickel-plated phosphor bronze

Contacts: Gold over nickel plated phosphor bronze

Frame: Tin over nickel plated brass

Case, Actuator, Plunger, Terminal Board: UL 94V-0 glass-filled Polyamide

Actuator Boot: Silicon Rubber

Standards & Specs

Sealed switch per IP 67

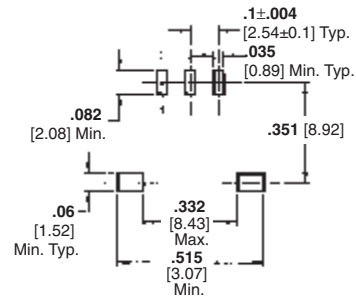
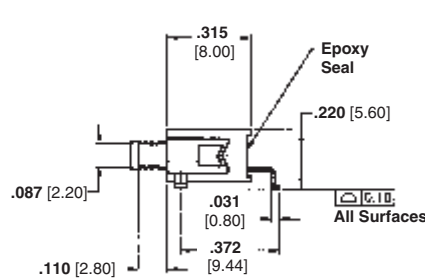
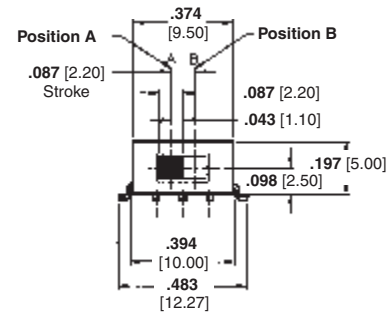
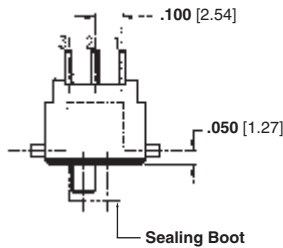

Recommended P.C.B. Pad Layout

SMT-Sealed Part Numbers

Tyco Electronics	Alcoswitch	Function
1571004-1	SE1GSMT	On-Off
1571004-2	SE1EGSMT	On-Off-On
1571004-3	SE1DGSMT	On-None-On

Tape & Reel Package

Tyco Electronics	Alcoswitch	Function
1571004-4	SE1GSMTTR	On-Off
1571004-5	SE1EGSMTTR	On-Off-On
1571004-6	SE1DGSMTTR	On-None-On

B
S/SE Series

Switch, Slide, PC Tail, S/SE GPC (Shown w/o Boot)

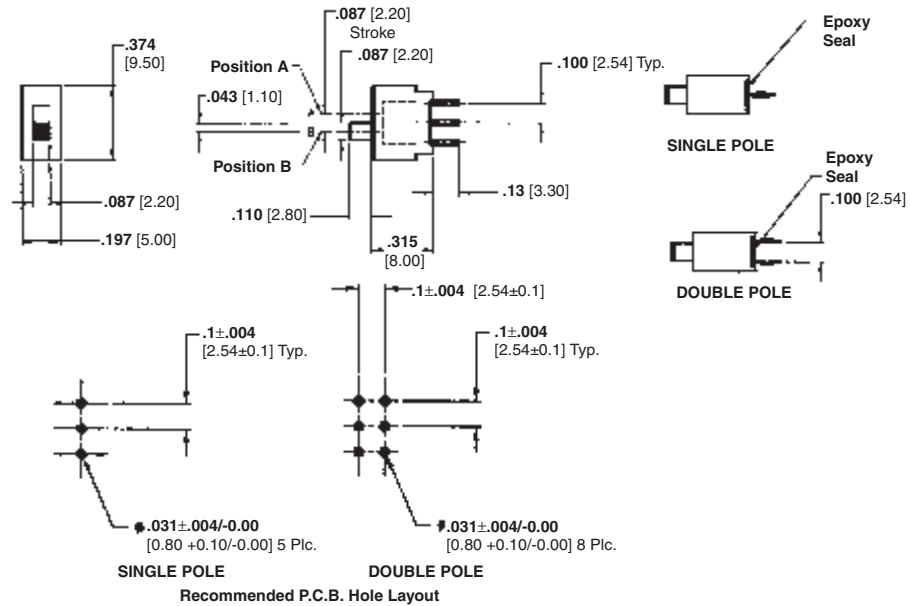

Sealed Part Numbers w/Boot

Tyco Electronics	Alcoswitch	Function
1437574-9	SE1DGPC	On-None-On
1-1437574-4	SE1EGPC	On-Off-On
1-1437574-6	SE2DGPC	On-None-On
2-1437574-0	SE2EGPC	On-Off-On

Unsealed Part Numbers w/o Boot

Tyco Electronics	Alcoswitch	Function
1571005-1	S1DGPC	On-None-On
1571005-2	S1EGPC	On-Off-On
1571005-3	S2DGPC	On-None-On
1571005-4	S2EGPC	On-Off-On

Switch, Slide, Right Angle, S/SE GRA (Shown w/o Boot)

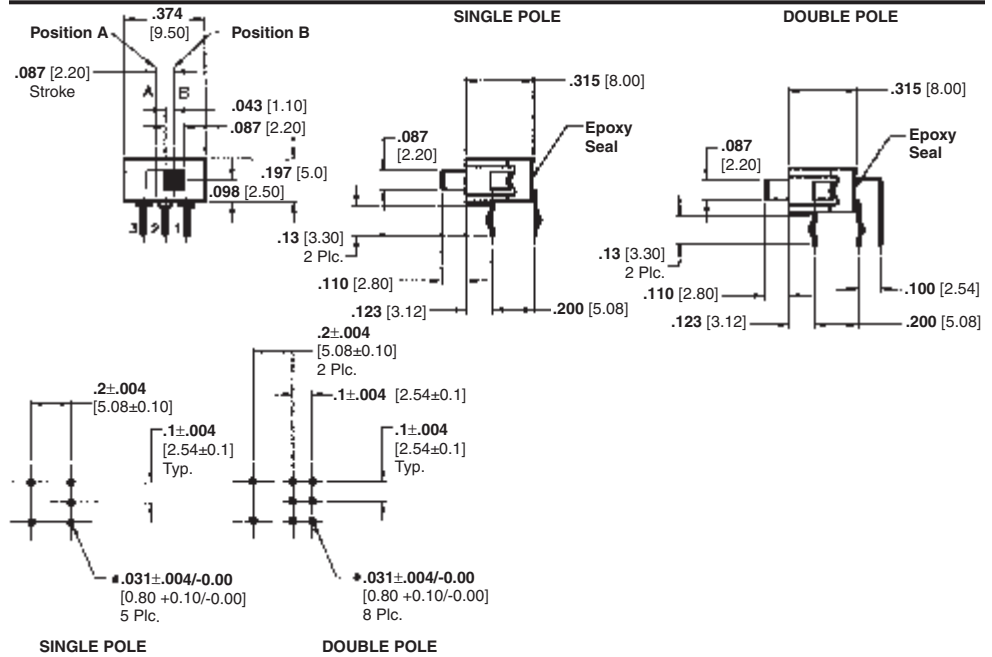

Sealed Part Numbers w/Boot

Tyco Electronics	Alcoswitch	Function
1-1437574-1	SE1DGRA	On-None-On
1-1437574-5	SE1EGRA	On-Off-On
1-1437574-8	SE2DGRA	On-None-On
2-1437574-1	SE2EGRA	On-Off-On

Unsealed Part Numbers w/o Boot

Tyco Electronics	Alcoswitch	Function
1571006-1	S1DGRA	On-None-On
1571006-2	S1EGRA	On-Off-On
1571006-3	S2DGRA	On-None-On
1571006-4	S2EGRA	On-Off-On

Slide Switches, Miniature, Low Profile, Economy Grade

MATERIAL SPECIFICATIONS:

ContactsSilver clad copper alloy
 Case MaterialSteel zinc plated
 Actuator MaterialPolyester (UL 94HB)
 Terminal SealEpoxy
 Terminals/Fixed ContactsSilver plate copper alloy

TYPICAL PERFORMANCE CHARACTERISTICS:

Contact Rating300 mA @ 125 VAC
 Initial Contact Resistance20 Milliohms max.
 Contact TimingMake-before-break
 Insulation Resistance100 Megohms min. @ 500 VDC
 Dielectric Strength500 VAC
 Actuation Force250 Grams, +150 Grams, -100 Grams
 Actuator Travel.....0.098" (2.49)
 Life ExpectancyUp to 10,000 Cycles

ENVIRONMENTAL SPECIFICATIONS:

Operating Temperature.....-5°F to 140°F (-15°C to +60°C)
 Storage Temperature.....-4°F to +158°F (-20°C to +70°C)
 Solder Heat ResistanceMIL-STD-202, Method 210

NOTICE: Bifurcated contact produces double wiping, self-cleaning contacts.

SPDT

Part Number			
Tyco Electronics	Alcoswitch	Plating	Mounting Style
5-1437577-8	STS121PC	Silver	Upright

SPDT

Part Number			
Tyco Electronics	Alcoswitch	Plating	Mounting Style
5-1437577-9	STS121RA	Silver	Right Angle

SP3T

Part Number			
Tyco Electronics	Alcoswitch	Plating	Mounting Style
6-1437577-2	STS131PC	Silver	Upright

SP3T

Part Number			
Tyco Electronics	Alcoswitch	Plating	Mounting Style
6-1437577-3	STS131RA	Silver	Right Angle

Slide Switches, Miniature, Low Profile, Economy Grade

SEE PAGE B13 FOR PRODUCT SPECIFICATIONS

SP3T



STS1300PC

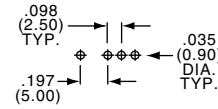
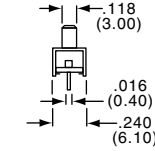
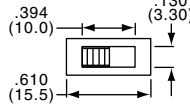
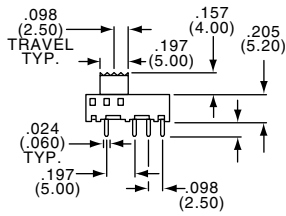

P. C. HOLE LAYOUT

SP3T



STS1300RA

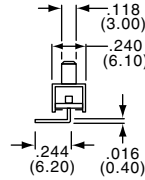
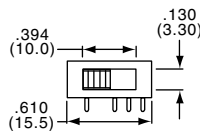

Part Number			
Tyco Electronics	Alcoswitch	Plating	Mounting Style
6-1437577-0	STS1300PC	Silver	Upright
6-1437577-1	STS1300RA	Silver	Right Angle

SP4T



STS1400PC

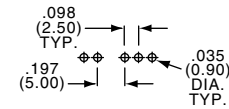
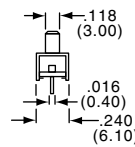
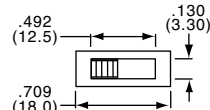
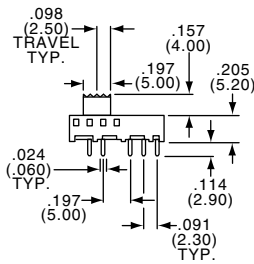

P. C. HOLE LAYOUT

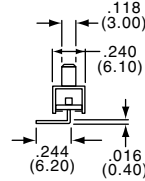
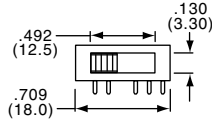

Part Number			
Tyco Electronics	Alcoswitch	Plating	Mounting Style
6-1437577-5	STS1400PC	Silver	Upright
6-1437577-6	STS1400RA	Silver	Right Angle

SP4T



STS141RA

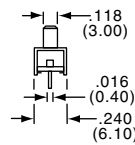
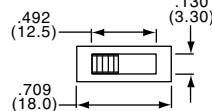
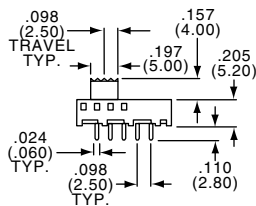

P. C. HOLE LAYOUT

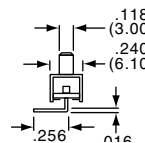
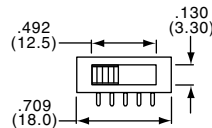

Part Number			
Tyco Electronics	Alcoswitch	Plating	Mounting Style
6-1437577-7	STS141PC	Silver	Upright
6-1437577-8	STS141RA	Silver	Right Angle

Slide Switches, Miniature, Low Profile, Economy Grade

SEE PAGE B13 FOR PRODUCT SPECIFICATIONS

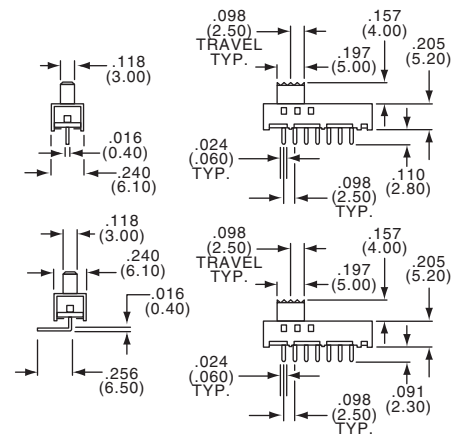
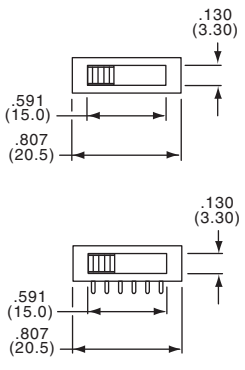
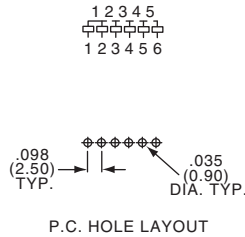

Part Number			
Tyco Electronics	Alcoswitch	Plating	Mounting Style
6-1437577-9	STS151PC	Silver	Upright
7-1437577-0	STS151RA	Silver	Right Angle

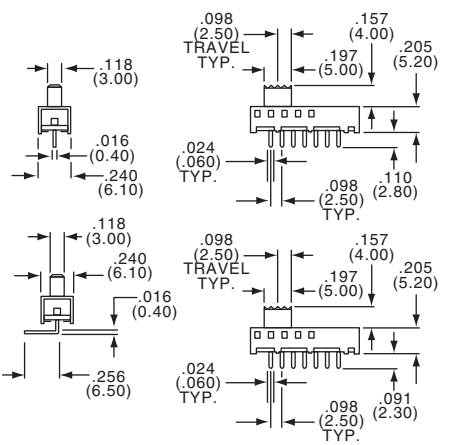
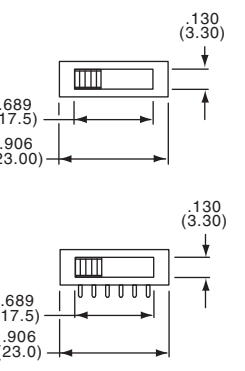
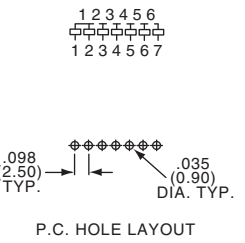

Part Number			
Tyco Electronics	Alcoswitch	Plating	Mounting Style
7-1437577-1	STS161PC	Silver	Upright
7-1437577-2	STS161RA	Silver	Right Angle

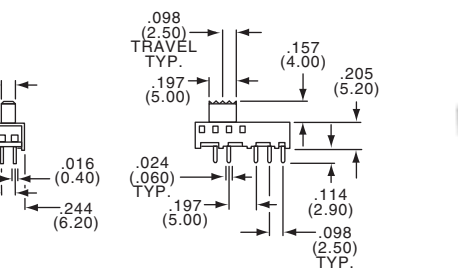
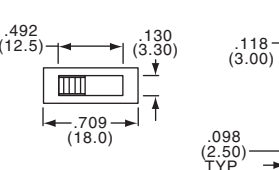
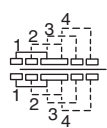
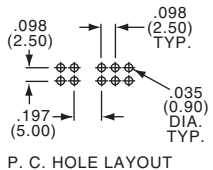
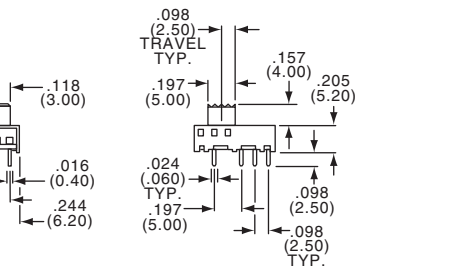
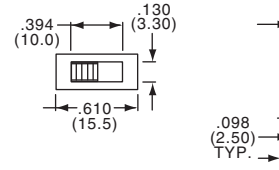
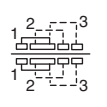
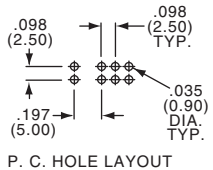

Part Number				
Tyco Electronics	Alcoswitch	Plating	Mounting Style	
7-1437577-4	STS2300PC	DP3T	Silver	Upright
7-1437577-6	STS2400PC	DP4T	Silver	Upright