

■ Pin Descriptions

Pin No.	Description
1	Input pin (In)
2	Ground pin (COM)
3	Output pin (Out)

■ Absolute Maximum Ratings at $T_a = 25^\circ\text{C}$

Parameter	Symbol	Rating	Unit
Supply voltage ^{*2}	V_{IN}	30	V
Supply current ^{*3}	I_{IN}	2.4	A
Power dissipation ^{*4}	P_D	5.0	W
Operating ambient temperature ^{*1}	T_{opr}	-30 to +85	$^\circ\text{C}$
Storage temperature ^{*1}	T_{stg}	-55 to +150	$^\circ\text{C}$

Note) *1: Expect for the operating ambient temperature and storage temperature, all ratings are for $T_a = 25^\circ\text{C}$.

*2: At the application of $V_{IN} = 30\text{ V}$, the overvoltage protection may be operated by the ASO protection circuit, leading to the output shut down.

*3: The current value does not exceed this criterion because of the on-chip current limiter.

*4: The internal circuit shuts off the output when $T_j \geq 150^\circ\text{C}$ (designed value). The relationship between the IC power dissipation and ambient temperature shall conform to the derating curve (■ Main Characteristics $P_D - T_a$).

■ Recommended Operating Conditions at $I_{OUT} = 500\text{ mA}$, $T_a = 25^\circ\text{C}$

Part No.	Output voltage	Operating supply voltage range (V_{IN})	Unit
AN77033SP	3.3	4.3 to 14	V
AN77035SP	3.5	4.5 to 14	V
AN7705SP	5	6 to 16	V
AN7706SP	6	7 to 17	V
AN7707SP	7	8 to 18	V
AN7708SP	8	9 to 19	V
AN7709SP	9	10 to 20	V
AN7710SP	10	11 to 21	V
AN7712SP	12	13 to 23	V
AN7715SP	15	16.5 to 26.5	V

■ Electrical Characteristics at $T_a = 25^\circ\text{C}$

• AN77033SP (3.3 V type)

Parameter	Symbol	Conditions	Min	Typ	Max	Unit
Output voltage	V_{OUT}	$V_{\text{IN}} = 4.3 \text{ V}$, $I_{\text{OUT}} = 500 \text{ mA}$, $T_j = 25^\circ\text{C}$	3.20	3.30	3.40	V
Line regulation	REG_{IN}	$V_{\text{IN}} = 4.3 \text{ V to } 14.3 \text{ V}$, $I_{\text{OUT}} = 500 \text{ mA}$, $T_j = 25^\circ\text{C}$	—	3	35	mV
Load regulation	REG_{LOA}	$V_{\text{IN}} = 4.3 \text{ V}$, $I_{\text{OUT}} = 0 \text{ mA to } 1200 \text{ mA}$, $T_j = 25^\circ\text{C}$	—	15	70	mV
Input dependency of bias current	$\Delta I_{\text{Bias(IN)}}$	$V_{\text{IN}} = 4.3 \text{ V to } 14.3 \text{ V}$, $I_{\text{OUT}} = 500 \text{ mA}$, $T_j = 25^\circ\text{C}$	—	1	10	mA
Load dependency of bias current	$\Delta I_{\text{Bias(LOA)}}$	$V_{\text{IN}} = 4.3 \text{ V}$, $I_{\text{OUT}} = 0 \text{ mA to } 1200 \text{ mA}$, $T_j = 25^\circ\text{C}$	—	10	50	mA
Bias current at no load	I_{Bias}	$V_{\text{IN}} = 4.3 \text{ V}$, $I_{\text{OUT}} = 0 \text{ mA}$	—	2.6	5.0	mA
Bias current before the regulation starts	I_{rush}	$V_{\text{IN}} = 3.0 \text{ V}$, $I_{\text{OUT}} = 0 \text{ mA}$	—	3	5	mA
Minimum I/O voltage difference 1	$V_{\text{DIF(min)1}}$	$V_{\text{IN}} = 3.7 \text{ V}$, $I_{\text{OUT}} = 500 \text{ mA}$, $T_j = 25^\circ\text{C}$	—	0.4	0.6	V
Minimum I/O voltage difference 2	$V_{\text{DIF(min)2}}$	$V_{\text{IN}} = 3.7 \text{ V}$, $I_{\text{OUT}} = 1200 \text{ mA}$, $T_j = 25^\circ\text{C}$	—	0.5	1.0	V
Peak output current 1 *	$I_{\text{O(Peak)1}}$	$V_{\text{IN}} = 4.3 \text{ V}$, $T_j = 25^\circ\text{C}$	1.2	1.8	2.4	A
Ripple rejection ratio	RR	$V_{\text{IN}} = 4.3 \text{ V to } 8.0 \text{ V}$, $I_{\text{OUT}} = 100 \text{ mA}$, $f = 120 \text{ Hz}$	53	74	—	dB

Note) *: This current exceeds $P_{\text{D(max)}}$ because it is a parameter during abnormal (overcurrent) operation. However, normally, it shall conform to the derating curve (■ Main Characteristics $P_{\text{D}} - T_a$).

• Design reference data

Note) The characteristics listed below are theoretical values based on the IC design and are not guaranteed.

Parameter	Symbol	Conditions	Min	Typ	Max	Unit
Peak output current 2 *	$I_{\text{O(Peak)2}}$	$V_{\text{IN}} = 13.3 \text{ V}$, $T_j = 25^\circ\text{C}$	—	1.5	—	A
Peak output current 3 *	$I_{\text{O(Peak)3}}$	$V_{\text{IN}} = 18.3 \text{ V}$, $T_j = 25^\circ\text{C}$	—	1.0	—	A
Output short-circuit current	$I_{\text{O(Short)}}$	$V_{\text{IN}} = 30 \text{ V}$, $T_j = 25^\circ\text{C}$ The load is shorted.	—	10	—	mA
Thermal protection operating temperature	$T_{\text{j(TH)}}$	$V_{\text{IN}} = 4.3 \text{ V}$	—	150	—	$^\circ\text{C}$
Output voltage temperature coefficient	a	$V_{\text{IN}} = 4.3 \text{ V}$, $T_j = 25^\circ\text{C to } 125^\circ\text{C}$	—	-40	—	ppm/ $^\circ\text{C}$

Note) *: This current exceeds $P_{\text{D(max)}}$ because it is a parameter during abnormal (overcurrent) operation. However, normally, it shall conform to the derating curve (■ Main Characteristics $P_{\text{D}} - T_a$).

■ Electrical Characteristics at $T_a = 25^\circ\text{C}$ (continued)

• AN77035SP (3.5 V type)

Parameter	Symbol	Conditions	Min	Typ	Max	Unit
Output voltage	V_{OUT}	$V_{\text{IN}} = 4.5 \text{ V}$, $I_{\text{OUT}} = 500 \text{ mA}$, $T_j = 25^\circ\text{C}$	3.39	3.50	3.61	V
Line regulation	REG_{IN}	$V_{\text{IN}} = 4.5 \text{ V to } 14.5 \text{ V}$, $I_{\text{OUT}} = 500 \text{ mA}$, $T_j = 25^\circ\text{C}$	—	3	35	mV
Load regulation	REG_{LOA}	$V_{\text{IN}} = 4.5 \text{ V}$, $I_{\text{OUT}} = 0 \text{ mA to } 1200 \text{ mA}$, $T_j = 25^\circ\text{C}$	—	15	70	mV
Input dependency of bias current	$\Delta I_{\text{Bias(IN)}}$	$V_{\text{IN}} = 4.5 \text{ V to } 14.5 \text{ V}$, $I_{\text{OUT}} = 500 \text{ mA}$, $T_j = 25^\circ\text{C}$	—	1	10	mA
Load dependency of bias current	$\Delta I_{\text{Bias(LOA)}}$	$V_{\text{IN}} = 4.5 \text{ V}$, $I_{\text{OUT}} = 0 \text{ mA to } 1200 \text{ mA}$, $T_j = 25^\circ\text{C}$	—	10	50	mA
Bias current at no load	I_{Bias}	$V_{\text{IN}} = 4.5 \text{ V}$, $I_{\text{OUT}} = 0 \text{ mA}$	—	2.6	5.0	mA
Bias current before the regulation starts	I_{rush}	$V_{\text{IN}} = 3.2 \text{ V}$, $I_{\text{OUT}} = 0 \text{ mA}$	—	3	5	mA
Minimum I/O voltage difference 1	$V_{\text{DIF(min)1}}$	$V_{\text{IN}} = 3.7 \text{ V}$, $I_{\text{OUT}} = 500 \text{ mA}$, $T_j = 25^\circ\text{C}$	—	0.4	0.6	V
Minimum I/O voltage difference 2	$V_{\text{DIF(min)2}}$	$V_{\text{IN}} = 3.7 \text{ V}$, $I_{\text{OUT}} = 1200 \text{ mA}$, $T_j = 25^\circ\text{C}$	—	0.5	1.0	V
Peak output current 1 *	$I_{\text{O(Peak)1}}$	$V_{\text{IN}} = 4.5 \text{ V}$, $T_j = 25^\circ\text{C}$	1.2	1.8	2.4	A
Ripple rejection ratio	RR	$V_{\text{IN}} = 4.5 \text{ V to } 8.0 \text{ V}$, $I_{\text{OUT}} = 100 \text{ mA}$, $f = 120 \text{ Hz}$	53	74	—	dB

Note) *: This current exceeds $P_{\text{D(max)}}$ because it is a parameter during abnormal (overcurrent) operation. However, normally, it shall conform to the derating curve (■ Main Characteristics $P_{\text{D}} - T_a$).

• Design reference data

Note) The characteristics listed below are theoretical values based on the IC design and are not guaranteed.

Parameter	Symbol	Conditions	Min	Typ	Max	Unit
Peak output current 2 *	$I_{\text{O(Peak)2}}$	$V_{\text{IN}} = 13.5 \text{ V}$, $T_j = 25^\circ\text{C}$	—	1.5	—	A
Peak output current 3 *	$I_{\text{O(Peak)3}}$	$V_{\text{IN}} = 18.5 \text{ V}$, $T_j = 25^\circ\text{C}$	—	1.0	—	A
Output short-circuit current	$I_{\text{O(Short)}}$	$V_{\text{IN}} = 30 \text{ V}$, $T_j = 25^\circ\text{C}$ The load is shorted.	—	10	—	mA
Thermal protection operating temperature	$T_{\text{j(TH)}}$	$V_{\text{IN}} = 4.5 \text{ V}$	—	150	—	$^\circ\text{C}$
Output voltage temperature coefficient	a	$V_{\text{IN}} = 4.5 \text{ V}$, $T_j = 25^\circ\text{C to } 125^\circ\text{C}$	—	-40	—	ppm/ $^\circ\text{C}$

Note) *: This current exceeds $P_{\text{D(max)}}$ because it is a parameter during abnormal (overcurrent) operation. However, normally, it shall conform to the derating curve (■ Main Characteristics $P_{\text{D}} - T_a$).

■ Electrical Characteristics at $T_a = 25^\circ\text{C}$ (continued)

• AN7705SP (5 V type)

Parameter	Symbol	Conditions	Min	Typ	Max	Unit
Output voltage	V_{OUT}	$V_{\text{IN}} = 6 \text{ V}$, $I_{\text{OUT}} = 500 \text{ mA}$, $T_j = 25^\circ\text{C}$	4.85	5.00	5.15	V
Line regulation	REG_{IN}	$V_{\text{IN}} = 6 \text{ V to } 16 \text{ V}$, $I_{\text{OUT}} = 500 \text{ mA}$, $T_j = 25^\circ\text{C}$	—	5	50	mV
Load regulation	REG_{LOA}	$V_{\text{IN}} = 6 \text{ V}$, $I_{\text{OUT}} = 0 \text{ mA to } 1200 \text{ mA}$, $T_j = 25^\circ\text{C}$	—	25	100	mV
Input dependency of bias current	$\Delta I_{\text{Bias(IN)}}$	$V_{\text{IN}} = 6 \text{ V to } 16 \text{ V}$, $I_{\text{OUT}} = 500 \text{ mA}$, $T_j = 25^\circ\text{C}$	—	1	10	mA
Load dependency of bias current	$\Delta I_{\text{Bias(LOA)}}$	$V_{\text{IN}} = 6 \text{ V}$, $I_{\text{OUT}} = 0 \text{ mA to } 1200 \text{ mA}$, $T_j = 25^\circ\text{C}$	—	10	50	mA
Bias current at no load	I_{Bias}	$V_{\text{IN}} = 6 \text{ V}$, $I_{\text{OUT}} = 0 \text{ mA}$	—	2.6	5	mA
Bias current before the regulation starts	I_{rush}	$V_{\text{IN}} = 4.5 \text{ V}$, $I_{\text{OUT}} = 0 \text{ mA}$	—	3	5	mA
Minimum I/O voltage difference 1	$V_{\text{DIF(min)1}}$	$V_{\text{IN}} = 4.5 \text{ V}$, $I_{\text{OUT}} = 500 \text{ mA}$, $T_j = 25^\circ\text{C}$	—	0.4	0.6	V
Minimum I/O voltage difference 2	$V_{\text{DIF(min)2}}$	$V_{\text{IN}} = 4.5 \text{ V}$, $I_{\text{OUT}} = 1200 \text{ mA}$, $T_j = 25^\circ\text{C}$	—	0.5	1.0	V
Peak output current 1 *	$I_{\text{O(Peak)1}}$	$V_{\text{IN}} = 6 \text{ V}$, $T_j = 25^\circ\text{C}$	1.2	1.8	2.4	A
Ripple rejection ratio	RR	$V_{\text{IN}} = 6 \text{ V to } 8 \text{ V}$, $I_{\text{OUT}} = 100 \text{ mA}$, $f = 120 \text{ Hz}$	50	70	—	dB

Note) *: This current exceeds $P_{\text{D(max)}}$ because it is a parameter during abnormal (overcurrent) operation. However, normally, it shall conform to the derating curve (■ Main Characteristics $P_{\text{D}} - T_a$).

• Design reference data

Note) The characteristics listed below are theoretical values based on the IC design and are not guaranteed.

Parameter	Symbol	Conditions	Min	Typ	Max	Unit
Peak output current 2 *	$I_{\text{O(Peak)2}}$	$V_{\text{IN}} = 15 \text{ V}$, $T_j = 25^\circ\text{C}$	—	1.5	—	A
Peak output current 3 *	$I_{\text{O(Peak)3}}$	$V_{\text{IN}} = 20 \text{ V}$, $T_j = 25^\circ\text{C}$	—	1.0	—	A
Output short-circuit current	$I_{\text{O(Short)}}$	$V_{\text{IN}} = 30 \text{ V}$, $T_j = 25^\circ\text{C}$ The load is shorted.	—	10	—	mA
Thermal protection operating temperature	$T_{\text{j(TH)}}$	$V_{\text{IN}} = 6 \text{ V}$	—	150	—	$^\circ\text{C}$
Output voltage temperature coefficient	a	$V_{\text{IN}} = 6 \text{ V}$, $T_j = 25^\circ\text{C to } 125^\circ\text{C}$	—	-40	—	ppm/ $^\circ\text{C}$

Note) *: This current exceeds $P_{\text{D(max)}}$ because it is a parameter during abnormal (overcurrent) operation. However, normally, it shall conform to the derating curve (■ Main Characteristics $P_{\text{D}} - T_a$).

■ Electrical Characteristics at $T_a = 25^\circ\text{C}$ (continued)

• AN7706SP (6 V type)

Parameter	Symbol	Conditions	Min	Typ	Max	Unit
Output voltage	V_{OUT}	$V_{\text{IN}} = 7 \text{ V}$, $I_{\text{OUT}} = 500 \text{ mA}$, $T_j = 25^\circ\text{C}$	5.82	6.00	6.18	V
Line regulation	REG_{IN}	$V_{\text{IN}} = 7 \text{ V to } 17 \text{ V}$, $I_{\text{OUT}} = 500 \text{ mA}$, $T_j = 25^\circ\text{C}$	—	6	60	mV
Load regulation	REG_{LOA}	$V_{\text{IN}} = 7 \text{ V}$, $I_{\text{OUT}} = 0 \text{ mA to } 1\,200 \text{ mA}$, $T_j = 25^\circ\text{C}$	—	30	120	mV
Input dependency of bias current	$\Delta I_{\text{Bias(IN)}}$	$V_{\text{IN}} = 7 \text{ V to } 17 \text{ V}$, $I_{\text{OUT}} = 500 \text{ mA}$, $T_j = 25^\circ\text{C}$	—	1	10	mA
Load dependency of bias current	$\Delta I_{\text{Bias(LOA)}}$	$V_{\text{IN}} = 7 \text{ V}$, $I_{\text{OUT}} = 0 \text{ mA to } 1\,200 \text{ mA}$, $T_j = 25^\circ\text{C}$	—	10	50	mA
Bias current at no load	I_{Bias}	$V_{\text{IN}} = 7 \text{ V}$, $I_{\text{OUT}} = 0 \text{ mA}$	—	2.6	5.0	mA
Bias current before the regulation starts	I_{rush}	$V_{\text{IN}} = 5.4 \text{ V}$, $I_{\text{OUT}} = 0 \text{ mA}$	—	3	5	mA
Minimum I/O voltage difference 1	$V_{\text{DIF(min)1}}$	$V_{\text{IN}} = 5.4 \text{ V}$, $I_{\text{OUT}} = 500 \text{ mA}$, $T_j = 25^\circ\text{C}$	—	0.4	0.6	V
Minimum I/O voltage difference 2	$V_{\text{DIF(min)2}}$	$V_{\text{IN}} = 5.4 \text{ V}$, $I_{\text{OUT}} = 1\,200 \text{ mA}$, $T_j = 25^\circ\text{C}$	—	0.5	1.0	V
Peak output current 1 *	$I_{\text{O(Peak)1}}$	$V_{\text{IN}} = 7 \text{ V}$, $T_j = 25^\circ\text{C}$	1.2	1.8	2.4	A
Ripple rejection ratio	RR	$V_{\text{IN}} = 7 \text{ V to } 9 \text{ V}$, $I_{\text{OUT}} = 100 \text{ mA}$, $f = 120 \text{ Hz}$	48	68	—	dB

Note) *: This current exceeds $P_{\text{D(max)}}$ because it is a parameter during abnormal (overcurrent) operation. However, normally, it shall conform to the derating curve (■ Main Characteristics $P_{\text{D}} - T_a$).

• Design reference data

Note) The characteristics listed below are theoretical values based on the IC design and are not guaranteed.

Parameter	Symbol	Conditions	Min	Typ	Max	Unit
Peak output current 2 *	$I_{\text{O(Peak)2}}$	$V_{\text{IN}} = 16 \text{ V}$, $T_j = 25^\circ\text{C}$	—	1.5	—	A
Peak output current 3 *	$I_{\text{O(Peak)3}}$	$V_{\text{IN}} = 21 \text{ V}$, $T_j = 25^\circ\text{C}$	—	1.0	—	A
Output short-circuit current	$I_{\text{O(Short)}}$	$V_{\text{IN}} = 30 \text{ V}$, $T_j = 25^\circ\text{C}$ The load is shorted.	—	10	—	mA
Thermal protection operating temperature	$T_{\text{j(TH)}}$	$V_{\text{IN}} = 7 \text{ V}$	—	150	—	$^\circ\text{C}$
Output voltage temperature coefficient	a	$V_{\text{IN}} = 7 \text{ V}$, $T_j = 25^\circ\text{C to } 125^\circ\text{C}$	—	-40	—	ppm/ $^\circ\text{C}$

Note) *: This current exceeds $P_{\text{D(max)}}$ because it is a parameter during abnormal (overcurrent) operation. However, normally, it shall conform to the derating curve (■ Main Characteristics $P_{\text{D}} - T_a$).

■ Electrical Characteristics at $T_a = 25^\circ\text{C}$ (continued)

• AN7707SP (7 V type)

Parameter	Symbol	Conditions	Min	Typ	Max	Unit
Output voltage	V_{OUT}	$V_{\text{IN}} = 8 \text{ V}$, $I_{\text{OUT}} = 500 \text{ mA}$, $T_j = 25^\circ\text{C}$	6.79	7.00	7.21	V
Line regulation	REG_{IN}	$V_{\text{IN}} = 8 \text{ V to } 18 \text{ V}$, $I_{\text{OUT}} = 500 \text{ mA}$, $T_j = 25^\circ\text{C}$	—	7	70	mV
Load regulation	REG_{LOA}	$V_{\text{IN}} = 8 \text{ V}$, $I_{\text{OUT}} = 0 \text{ mA to } 1\,200 \text{ mA}$, $T_j = 25^\circ\text{C}$	—	35	140	mV
Input dependency of bias current	$\Delta I_{\text{Bias(IN)}}$	$V_{\text{IN}} = 8 \text{ V to } 18 \text{ V}$, $I_{\text{OUT}} = 500 \text{ mA}$, $T_j = 25^\circ\text{C}$	—	1	10	mA
Load dependency of bias current	$\Delta I_{\text{Bias(LOA)}}$	$V_{\text{IN}} = 8 \text{ V}$, $I_{\text{OUT}} = 0 \text{ mA to } 1\,200 \text{ mA}$, $T_j = 25^\circ\text{C}$	—	10	50	mA
Bias current at no load	I_{Bias}	$V_{\text{IN}} = 8 \text{ V}$, $I_{\text{OUT}} = 0 \text{ mA}$	—	2.6	5.0	mA
Bias current before the regulation starts	I_{rush}	$V_{\text{IN}} = 6.3 \text{ V}$, $I_{\text{OUT}} = 0 \text{ mA}$	—	3	5	mA
Minimum I/O voltage difference 1	$V_{\text{DIF(min)1}}$	$V_{\text{IN}} = 6.3 \text{ V}$, $I_{\text{OUT}} = 500 \text{ mA}$, $T_j = 25^\circ\text{C}$	—	0.4	0.6	V
Minimum I/O voltage difference 2	$V_{\text{DIF(min)2}}$	$V_{\text{IN}} = 6.3 \text{ V}$, $I_{\text{OUT}} = 1\,200 \text{ mA}$, $T_j = 25^\circ\text{C}$	—	0.5	1.0	V
Peak output current 1 *	$I_{\text{O(Peak)1}}$	$V_{\text{IN}} = 8 \text{ V}$, $T_j = 25^\circ\text{C}$	1.2	1.8	2.4	A
Ripple rejection ratio	RR	$V_{\text{IN}} = 8 \text{ V to } 10 \text{ V}$, $I_{\text{OUT}} = 100 \text{ mA}$, $f = 120 \text{ Hz}$	47	67	—	dB

Note) *: This current exceeds $P_{\text{D(max)}}$ because it is a parameter during abnormal (overcurrent) operation. However, normally, it shall conform to the derating curve (■ Main Characteristics $P_{\text{D}} - T_a$).

• Design reference data

Note) The characteristics listed below are theoretical values based on the IC design and are not guaranteed.

Parameter	Symbol	Conditions	Min	Typ	Max	Unit
Peak output current 2 *	$I_{\text{O(Peak)2}}$	$V_{\text{IN}} = 17 \text{ V}$, $T_j = 25^\circ\text{C}$	—	1.5	—	A
Peak output current 3 *	$I_{\text{O(Peak)3}}$	$V_{\text{IN}} = 22 \text{ V}$, $T_j = 25^\circ\text{C}$	—	1.0	—	A
Output short-circuit current	$I_{\text{O(Short)}}$	$V_{\text{IN}} = 30 \text{ V}$, $T_j = 25^\circ\text{C}$ The load is shorted.	—	10	—	mA
Thermal protection operating temperature	$T_{\text{j(TH)}}$	$V_{\text{IN}} = 8 \text{ V}$	—	150	—	$^\circ\text{C}$
Output voltage temperature coefficient	a	$V_{\text{IN}} = 8 \text{ V}$, $T_j = 25^\circ\text{C to } 125^\circ\text{C}$	—	-40	—	ppm/ $^\circ\text{C}$

Note) *: This current exceeds $P_{\text{D(max)}}$ because it is a parameter during abnormal (overcurrent) operation. However, normally, it shall conform to the derating curve (■ Main Characteristics $P_{\text{D}} - T_a$).

■ Electrical Characteristics at $T_a = 25^\circ\text{C}$ (continued)

• AN7708SP (8 V type)

Parameter	Symbol	Conditions	Min	Typ	Max	Unit
Output voltage	V_{OUT}	$V_{\text{IN}} = 9\text{ V}$, $I_{\text{OUT}} = 500\text{ mA}$, $T_j = 25^\circ\text{C}$	7.76	8.00	8.24	V
Line regulation	REG_{IN}	$V_{\text{IN}} = 9\text{ V to } 19\text{ V}$, $I_{\text{OUT}} = 500\text{ mA}$, $T_j = 25^\circ\text{C}$	—	8	80	mV
Load regulation	REG_{LOA}	$V_{\text{IN}} = 9\text{ V}$, $I_{\text{OUT}} = 0\text{ mA to } 1\,200\text{ mA}$, $T_j = 25^\circ\text{C}$	—	40	160	mV
Input dependency of bias current	$\Delta I_{\text{Bias(IN)}}$	$V_{\text{IN}} = 9\text{ V to } 19\text{ V}$, $I_{\text{OUT}} = 500\text{ mA}$, $T_j = 25^\circ\text{C}$	—	1	10	mA
Load dependency of bias current	$\Delta I_{\text{Bias(LOA)}}$	$V_{\text{IN}} = 9\text{ V}$, $I_{\text{OUT}} = 0\text{ mA to } 1\,200\text{ mA}$, $T_j = 25^\circ\text{C}$	—	10	50	mA
Bias current at no load	I_{Bias}	$V_{\text{IN}} = 9\text{ V}$, $I_{\text{OUT}} = 0\text{ mA}$	—	2.6	5.0	mA
Bias current before the regulation starts	I_{rush}	$V_{\text{IN}} = 7.2\text{ V}$, $I_{\text{OUT}} = 0\text{ mA}$	—	3	5	mA
Minimum I/O voltage difference 1	$V_{\text{DIF(min)1}}$	$V_{\text{IN}} = 7.2\text{ V}$, $I_{\text{OUT}} = 500\text{ mA}$, $T_j = 25^\circ\text{C}$	—	0.4	0.6	V
Minimum I/O voltage difference 2	$V_{\text{DIF(min)2}}$	$V_{\text{IN}} = 7.2\text{ V}$, $I_{\text{OUT}} = 1\,200\text{ mA}$, $T_j = 25^\circ\text{C}$	—	0.5	1.0	V
Peak output current 1 *	$I_{\text{O(Peak)1}}$	$V_{\text{IN}} = 9\text{ V}$, $T_j = 25^\circ\text{C}$	1.2	1.8	2.4	A
Ripple rejection ratio	RR	$V_{\text{IN}} = 9\text{ V to } 11\text{ V}$, $I_{\text{OUT}} = 100\text{ mA}$, $f = 120\text{ Hz}$	46	66	—	dB

Note) *: This current exceeds $P_{\text{D(max)}}$ because it is a parameter during abnormal (overcurrent) operation. However, normally, it shall conform to the derating curve (■ Main Characteristics $P_{\text{D}} - T_a$).

• Design reference data

Note) The characteristics listed below are theoretical values based on the IC design and are not guaranteed.

Parameter	Symbol	Conditions	Min	Typ	Max	Unit
Peak output current 2 *	$I_{\text{O(Peak)2}}$	$V_{\text{IN}} = 18\text{ V}$, $T_j = 25^\circ\text{C}$	—	1.5	—	A
Peak output current 3 *	$I_{\text{O(Peak)3}}$	$V_{\text{IN}} = 23\text{ V}$, $T_j = 25^\circ\text{C}$	—	1.0	—	A
Output short-circuit current	$I_{\text{O(Short)}}$	$V_{\text{IN}} = 30\text{ V}$, $T_j = 25^\circ\text{C}$ The load is shorted.	—	10	—	mA
Thermal protection operating temperature	$T_{\text{j(TH)}}$	$V_{\text{IN}} = 9\text{ V}$	—	150	—	$^\circ\text{C}$
Output voltage temperature coefficient	a	$V_{\text{IN}} = 9\text{ V}$, $T_j = 25^\circ\text{C to } 125^\circ\text{C}$	—	-40	—	ppm/ $^\circ\text{C}$

Note) *: This current exceeds $P_{\text{D(max)}}$ because it is a parameter during abnormal (overcurrent) operation. However, normally, it shall conform to the derating curve (■ Main Characteristics $P_{\text{D}} - T_a$).

■ Electrical Characteristics at $T_a = 25^\circ\text{C}$ (continued)

• AN7709SP (9 V type)

Parameter	Symbol	Conditions	Min	Typ	Max	Unit
Output voltage	V_{OUT}	$V_{\text{IN}} = 10 \text{ V}$, $I_{\text{OUT}} = 500 \text{ mA}$, $T_j = 25^\circ\text{C}$	8.73	9.00	9.27	V
Line regulation	REG_{IN}	$V_{\text{IN}} = 10 \text{ V to } 20 \text{ V}$, $I_{\text{OUT}} = 500 \text{ mA}$, $T_j = 25^\circ\text{C}$	—	9	90	mV
Load regulation	REG_{LOA}	$V_{\text{IN}} = 10 \text{ V}$, $I_{\text{OUT}} = 0 \text{ mA to } 1200 \text{ mA}$, $T_j = 25^\circ\text{C}$	—	45	180	mV
Input dependency of bias current	$\Delta I_{\text{Bias(IN)}}$	$V_{\text{IN}} = 10 \text{ V to } 20 \text{ V}$, $I_{\text{OUT}} = 500 \text{ mA}$, $T_j = 25^\circ\text{C}$	—	1	10	mA
Load dependency of bias current	$\Delta I_{\text{Bias(LOA)}}$	$V_{\text{IN}} = 10 \text{ V}$, $I_{\text{OUT}} = 0 \text{ mA to } 1200 \text{ mA}$, $T_j = 25^\circ\text{C}$	—	10	50	mA
Bias current at no load	I_{Bias}	$V_{\text{IN}} = 10 \text{ V}$, $I_{\text{OUT}} = 0 \text{ mA}$	—	2.6	5.0	mA
Bias current before the regulation starts	I_{rush}	$V_{\text{IN}} = 8.1 \text{ V}$, $I_{\text{OUT}} = 0 \text{ mA}$	—	3	5	mA
Minimum I/O voltage difference 1	$V_{\text{DIF(min)1}}$	$V_{\text{IN}} = 8.1 \text{ V}$, $I_{\text{OUT}} = 500 \text{ mA}$, $T_j = 25^\circ\text{C}$	—	0.4	0.6	V
Minimum I/O voltage difference 2	$V_{\text{DIF(min)2}}$	$V_{\text{IN}} = 8.1 \text{ V}$, $I_{\text{OUT}} = 1200 \text{ mA}$, $T_j = 25^\circ\text{C}$	—	0.5	1.0	V
Peak output current 1 *	$I_{\text{O(Peak)1}}$	$V_{\text{IN}} = 10 \text{ V}$, $T_j = 25^\circ\text{C}$	1.2	1.8	2.4	A
Ripple rejection ratio	RR	$V_{\text{IN}} = 10 \text{ V to } 12 \text{ V}$, $I_{\text{OUT}} = 100 \text{ mA}$, $f = 120 \text{ Hz}$	45	65	—	dB

Note) *: This current exceeds $P_{\text{D(max)}}$ because it is a parameter during abnormal (overcurrent) operation. However, normally, it shall conform to the derating curve (■ Main Characteristics $P_{\text{D}} - T_a$).

• Design reference data

Note) The characteristics listed below are theoretical values based on the IC design and are not guaranteed.

Parameter	Symbol	Conditions	Min	Typ	Max	Unit
Peak output current 2 *	$I_{\text{O(Peak)2}}$	$V_{\text{IN}} = 19 \text{ V}$, $T_j = 25^\circ\text{C}$	—	1.5	—	A
Peak output current 3 *	$I_{\text{O(Peak)3}}$	$V_{\text{IN}} = 24 \text{ V}$, $T_j = 25^\circ\text{C}$	—	1.0	—	A
Output short-circuit current	$I_{\text{O(Short)}}$	$V_{\text{IN}} = 30 \text{ V}$, $T_j = 25^\circ\text{C}$ The load is shorted.	—	10	—	mA
Thermal protection operating temperature	$T_{\text{j(TH)}}$	$V_{\text{IN}} = 10 \text{ V}$	—	150	—	$^\circ\text{C}$
Output voltage temperature coefficient	a	$V_{\text{IN}} = 10 \text{ V}$, $T_j = 25^\circ\text{C to } 125^\circ\text{C}$	—	-40	—	ppm/ $^\circ\text{C}$

Note) *: This current exceeds $P_{\text{D(max)}}$ because it is a parameter during abnormal (overcurrent) operation. However, normally, it shall conform to the derating curve (■ Main Characteristics $P_{\text{D}} - T_a$).

■ Electrical Characteristics at $T_a = 25^\circ\text{C}$ (continued)

• AN7710SP (10 V type)

Parameter	Symbol	Conditions	Min	Typ	Max	Unit
Output voltage	V_{OUT}	$V_{\text{IN}} = 11 \text{ V}$, $I_{\text{OUT}} = 500 \text{ mA}$, $T_j = 25^\circ\text{C}$	9.7	10.0	10.3	V
Line regulation	REG_{IN}	$V_{\text{IN}} = 11 \text{ V}$ to 21 V , $I_{\text{OUT}} = 500 \text{ mA}$, $T_j = 25^\circ\text{C}$	—	10	100	mV
Load regulation	REG_{LOA}	$V_{\text{IN}} = 11 \text{ V}$, $I_{\text{OUT}} = 0 \text{ mA}$ to 1200 mA , $T_j = 25^\circ\text{C}$	—	50	200	mV
Input dependency of bias current	$\Delta I_{\text{Bias(IN)}}$	$V_{\text{IN}} = 11 \text{ V}$ to 21 V , $I_{\text{OUT}} = 500 \text{ mA}$, $T_j = 25^\circ\text{C}$	—	1	10	mA
Load dependency of bias current	$\Delta I_{\text{Bias(LOA)}}$	$V_{\text{IN}} = 11 \text{ V}$, $I_{\text{OUT}} = 0 \text{ mA}$ to 1200 mA , $T_j = 25^\circ\text{C}$	—	10	50	mA
Bias current at no load	I_{Bias}	$V_{\text{IN}} = 11 \text{ V}$, $I_{\text{OUT}} = 0 \text{ mA}$	—	2.6	5.0	mA
Bias current before the regulation starts	I_{rush}	$V_{\text{IN}} = 9 \text{ V}$, $I_{\text{OUT}} = 0 \text{ mA}$	—	3	5	mA
Minimum I/O voltage difference 1	$V_{\text{DIF(min)1}}$	$V_{\text{IN}} = 9 \text{ V}$, $I_{\text{OUT}} = 500 \text{ mA}$, $T_j = 25^\circ\text{C}$	—	0.4	0.6	V
Minimum I/O voltage difference 2	$V_{\text{DIF(min)2}}$	$V_{\text{IN}} = 9 \text{ V}$, $I_{\text{OUT}} = 1200 \text{ mA}$, $T_j = 25^\circ\text{C}$	—	0.5	1.0	V
Peak output current 1 *	$I_{\text{O(Peak)1}}$	$V_{\text{IN}} = 11 \text{ V}$, $T_j = 25^\circ\text{C}$	1.2	1.8	2.4	A
Ripple rejection ratio	RR	$V_{\text{IN}} = 11 \text{ V}$ to 13 V , $I_{\text{OUT}} = 100 \text{ mA}$, $f = 120 \text{ Hz}$	44	64	—	dB

Note) *: This current exceeds $P_{\text{D(max)}}$ because it is a parameter during abnormal (overcurrent) operation. However, normally, it shall conform to the derating curve (■ Main Characteristics $P_{\text{D}} - T_a$).

• Design reference data

Note) The characteristics listed below are theoretical values based on the IC design and are not guaranteed.

Parameter	Symbol	Conditions	Min	Typ	Max	Unit
Peak output current 2 *	$I_{\text{O(Peak)2}}$	$V_{\text{IN}} = 20 \text{ V}$, $T_j = 25^\circ\text{C}$	—	1.5	—	A
Peak output current 3 *	$I_{\text{O(Peak)3}}$	$V_{\text{IN}} = 25 \text{ V}$, $T_j = 25^\circ\text{C}$	—	1.0	—	A
Output short-circuit current	$I_{\text{O(Short)}}$	$V_{\text{IN}} = 30 \text{ V}$, $T_j = 25^\circ\text{C}$ The load is shorted.	—	10	—	mA
Thermal protection operating temperature	$T_{\text{j(TH)}}$	$V_{\text{IN}} = 11 \text{ V}$	—	150	—	$^\circ\text{C}$
Output voltage temperature coefficient	a	$V_{\text{IN}} = 11 \text{ V}$, $T_j = 25^\circ\text{C}$ to 125°C	—	-40	—	ppm/ $^\circ\text{C}$

Note) *: This current exceeds $P_{\text{D(max)}}$ because it is a parameter during abnormal (overcurrent) operation. However, normally, it shall conform to the derating curve (■ Main Characteristics $P_{\text{D}} - T_a$).

■ Electrical Characteristics at $T_a = 25^\circ\text{C}$ (continued)

• AN7712SP (12 V type)

Parameter	Symbol	Conditions	Min	Typ	Max	Unit
Output voltage	V_{OUT}	$V_{\text{IN}} = 13 \text{ V}$, $I_{\text{OUT}} = 500 \text{ mA}$, $T_j = 25^\circ\text{C}$	11.64	12.00	12.36	V
Line regulation	REG_{IN}	$V_{\text{IN}} = 13 \text{ V to } 23 \text{ V}$, $I_{\text{OUT}} = 500 \text{ mA}$, $T_j = 25^\circ\text{C}$	—	12	120	mV
Load regulation	REG_{LOA}	$V_{\text{IN}} = 13 \text{ V}$, $I_{\text{OUT}} = 0 \text{ mA to } 1200 \text{ mA}$, $T_j = 25^\circ\text{C}$	—	60	240	mV
Input dependency of bias current	$\Delta I_{\text{Bias(IN)}}$	$V_{\text{IN}} = 13 \text{ V to } 23 \text{ V}$, $I_{\text{OUT}} = 500 \text{ mA}$, $T_j = 25^\circ\text{C}$	—	1	10	mA
Load dependency of bias current	$\Delta I_{\text{Bias(LOA)}}$	$V_{\text{IN}} = 13 \text{ V}$, $I_{\text{OUT}} = 0 \text{ mA to } 1200 \text{ mA}$, $T_j = 25^\circ\text{C}$	—	10	50	mA
Bias current at no load	I_{Bias}	$V_{\text{IN}} = 13 \text{ V}$, $I_{\text{OUT}} = 0 \text{ mA}$	—	2.6	5.0	mA
Bias current before the regulation starts	I_{rush}	$V_{\text{IN}} = 10.8 \text{ V}$, $I_{\text{OUT}} = 0 \text{ mA}$	—	3	5	mA
Minimum I/O voltage difference 1	$V_{\text{DIF(min)1}}$	$V_{\text{IN}} = 10.8 \text{ V}$, $I_{\text{OUT}} = 500 \text{ mA}$, $T_j = 25^\circ\text{C}$	—	0.4	0.6	V
Minimum I/O voltage difference 2	$V_{\text{DIF(min)2}}$	$V_{\text{IN}} = 10.8 \text{ V}$, $I_{\text{OUT}} = 1200 \text{ mA}$, $T_j = 25^\circ\text{C}$	—	0.5	1.0	V
Peak output current 1 *	$I_{\text{O(Peak)1}}$	$V_{\text{IN}} = 13 \text{ V}$, $T_j = 25^\circ\text{C}$	1.2	1.8	2.4	A
Ripple rejection ratio	RR	$V_{\text{IN}} = 13 \text{ V to } 15 \text{ V}$, $I_{\text{OUT}} = 100 \text{ mA}$, $f = 120 \text{ Hz}$	42	62	—	dB

Note) *: This current exceeds $P_{\text{D(max)}}$ because it is a parameter during abnormal (overcurrent) operation. However, normally, it shall conform to the derating curve (■ Main Characteristics $P_{\text{D}} - T_a$).

• Design reference data

Note) The characteristics listed below are theoretical values based on the IC design and are not guaranteed.

Parameter	Symbol	Conditions	Min	Typ	Max	Unit
Peak output current 2 *	$I_{\text{O(Peak)2}}$	$V_{\text{IN}} = 22 \text{ V}$, $T_j = 25^\circ\text{C}$	—	1.5	—	A
Peak output current 3 *	$I_{\text{O(Peak)3}}$	$V_{\text{IN}} = 27 \text{ V}$, $T_j = 25^\circ\text{C}$	—	1.0	—	A
Output short-circuit current	$I_{\text{O(Short)}}$	$V_{\text{IN}} = 30 \text{ V}$, $T_j = 25^\circ\text{C}$ The load is shorted.	—	10	—	mA
Thermal protection operating temperature	$T_{\text{j(TH)}}$	$V_{\text{IN}} = 13 \text{ V}$	—	150	—	$^\circ\text{C}$
Output voltage temperature coefficient	a	$V_{\text{IN}} = 13 \text{ V}$, $T_j = 25^\circ\text{C to } 125^\circ\text{C}$	—	-40	—	ppm/ $^\circ\text{C}$

Note) *: This current exceeds $P_{\text{D(max)}}$ because it is a parameter during abnormal (overcurrent) operation. However, normally, it shall conform to the derating curve (■ Main Characteristics $P_{\text{D}} - T_a$).

■ Electrical Characteristics at $T_a = 25^\circ\text{C}$ (continued)

• AN7715SP (15 V type)

Parameter	Symbol	Conditions	Min	Typ	Max	Unit
Output voltage	V_{OUT}	$V_{\text{IN}} = 16.5 \text{ V}$, $I_{\text{OUT}} = 500 \text{ mA}$, $T_j = 25^\circ\text{C}$	14.55	15.00	15.45	V
Line regulation	REG_{IN}	$V_{\text{IN}} = 16.5 \text{ V}$ to 26.5 V , $I_{\text{OUT}} = 500 \text{ mA}$, $T_j = 25^\circ\text{C}$	—	15	150	mV
Load regulation	REG_{LOA}	$V_{\text{IN}} = 16.5 \text{ V}$, $I_{\text{OUT}} = 0 \text{ mA}$ to 1200 mA , $T_j = 25^\circ\text{C}$	—	75	300	mV
Input dependency of bias current	$\Delta I_{\text{Bias(IN)}}$	$V_{\text{IN}} = 16.5 \text{ V}$ to 26.5 V , $I_{\text{OUT}} = 500 \text{ mA}$, $T_j = 25^\circ\text{C}$	—	1	10	mA
Load dependency of bias current	$\Delta I_{\text{Bias(LOA)}}$	$V_{\text{IN}} = 16.5 \text{ V}$, $I_{\text{OUT}} = 0 \text{ mA}$ to 1200 mA , $T_j = 25^\circ\text{C}$	—	10	50	mA
Bias current at no load	I_{Bias}	$V_{\text{IN}} = 16.5 \text{ V}$, $I_{\text{OUT}} = 0 \text{ mA}$	—	2.6	5	mA
Bias current before the regulation starts	I_{rush}	$V_{\text{IN}} = 13.5 \text{ V}$, $I_{\text{OUT}} = 0 \text{ mA}$	—	3	5	mA
Minimum I/O voltage difference 1	$V_{\text{DIF(min)1}}$	$V_{\text{IN}} = 13.5 \text{ V}$, $I_{\text{OUT}} = 500 \text{ mA}$, $T_j = 25^\circ\text{C}$	—	0.4	0.6	V
Minimum I/O voltage difference 2	$V_{\text{DIF(min)2}}$	$V_{\text{IN}} = 13.5 \text{ V}$, $I_{\text{OUT}} = 1200 \text{ mA}$, $T_j = 25^\circ\text{C}$	—	0.5	1.0	V
Peak output current 1 *	$I_{\text{O(Peak)1}}$	$V_{\text{IN}} = 16.5 \text{ V}$, $T_j = 25^\circ\text{C}$	1.2	1.8	2.4	A
Ripple rejection ratio	RR	$V_{\text{IN}} = 16.5 \text{ V}$ to 18.5 V , $I_{\text{OUT}} = 100 \text{ mA}$, $f = 120 \text{ Hz}$	40	60	—	dB

Note) *: This current exceeds $P_{\text{D(max)}}$ because it is a parameter during abnormal (overcurrent) operation. However, normally, it shall conform to the derating curve (■ Main Characteristics $P_{\text{D}} - T_a$).

• Design reference data

Note) The characteristics listed below are theoretical values based on the IC design and are not guaranteed.

Parameter	Symbol	Conditions	Min	Typ	Max	Unit
Peak output current 2 *	$I_{\text{O(Peak)2}}$	$V_{\text{IN}} = 25 \text{ V}$, $T_j = 25^\circ\text{C}$	—	1.5	—	A
Output short-circuit current	$I_{\text{O(Short)}}$	$V_{\text{IN}} = 30 \text{ V}$, $T_j = 25^\circ\text{C}$ The load is shorted.	—	10	—	mA
Thermal protection operating temperature	$T_{\text{j(TH)}}$	$V_{\text{IN}} = 16.5 \text{ V}$	—	150	—	$^\circ\text{C}$
Output voltage temperature coefficient	a	$V_{\text{IN}} = 16.5 \text{ V}$, $T_j = 25^\circ\text{C}$ to 125°C	—	-40	—	ppm/ $^\circ\text{C}$

Note) *: This current exceeds $P_{\text{D(max)}}$ because it is a parameter during abnormal (overcurrent) operation. However, normally, it shall conform to the derating curve (■ Main Characteristics $P_{\text{D}} - T_a$).

■ Usage Notes

1. Input short-circuit protection circuit

When the DC input pin (pin 1) and the ground pin (pin 2) of our conventional three-pin regulators (AN78xxNSP series, etc.) were short-circuited at normal use conditions in some cases, the voltage of the output pin (pin 3) becomes higher than that of the DC input pin and electrons charged in the output capacitor C_{OUT} flow into the input side, resulting in break of the element.

In those cases, it was necessary for you to connect a general silicon diode as shown in the figure on the right. In the AN77xxSP series, however, it is not necessary to connect the protection diode because these series have a built-in protection circuit to safeguard the element from discharge current.

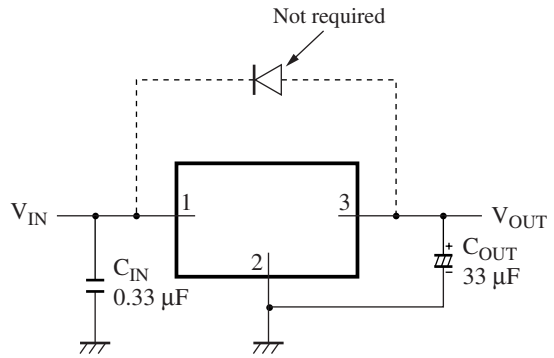

2. Capacitor for external compensation

To maintain the stability, insert a 33 mF capacitor as close to pin 3 and pin 2 as possible. In case of using at low temperature, decrease in capacity of the aluminum electrolytic capacitor and increase of ESR of this capacitor may lead to oscillation.

In the AN77xxSP series, for the output capacitor C_{OUT} , it is recommended to use an aluminum electrolytic capacitor or tantalum capacitor whose equivalent series resistance (ESR) has the temperature characteristic within the recommended area shown on the right.

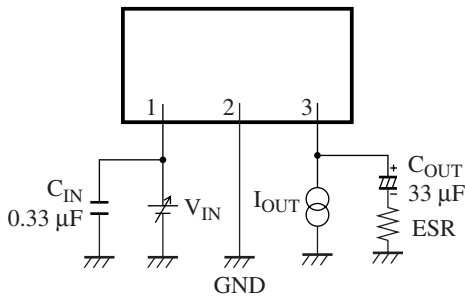

Output capacitor ESR
(Equivalent series resistance) $T_a = 25^\circ\text{C}$

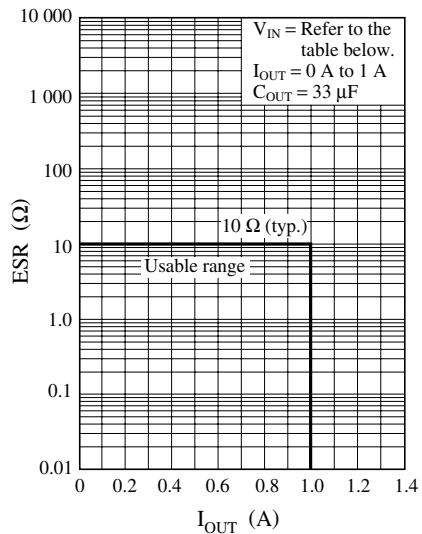

Part No.	V_{IN}
AN77033SP	4.3 V to 14 V
AN77035SP	4.5 V to 14 V
AN7705SP	6 V to 16 V
AN7706SP	7 V to 17 V
AN7707SP	8 V to 18 V
AN7708SP	9 V to 19 V
AN7709SP	10 V to 20 V
AN7710SP	11 V to 21 V
AN7712SP	13 V to 23 V
AN7715SP	16.5 V to 26.5 V

3. Others

Cautions for the input voltage that exceeds the operating supply voltage:

- 1) The overvoltage protection is activated with the ASO protection circuit when $V_{IN} = 30\text{ V}$ is applied, and the output shuts down occasionally. (3 V type to 10 V type)
- 2) Please note that at $I_{OUT} < 2\text{ mA}$, the output voltage rises and may exceed the maximum of the operation range. (12 V type to 24 V type)

■ Main Characteristics

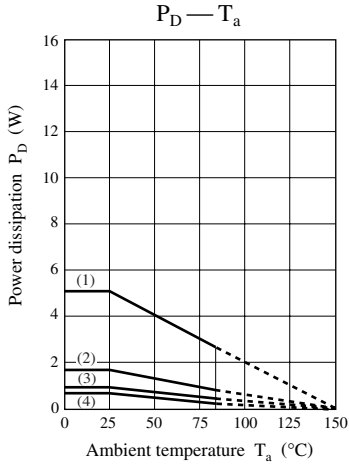

- (1) When AL board is mounted
(Basic size : $50 \times 50 \times t2.0 \text{ mm}^3$)
 $R_{th(j-a)} = 25.0^\circ\text{C/W}$
- (2) When glass epoxy is mounted 2
(Basic size : $50 \times 50 \times t1.5 \text{ mm}^3$)
 $R_{th(j-a)} = 89.3^\circ\text{C/W}$
- (3) When glass epoxy is mounted 1
(Basic size : $50 \times 50 \times t1.7 \text{ mm}^3$)
 $R_{th(j-a)} = 147.0^\circ\text{C/W}$
- (4) Without heat sink
 $R_{th(j-a)} = 178.0^\circ\text{C/W}$

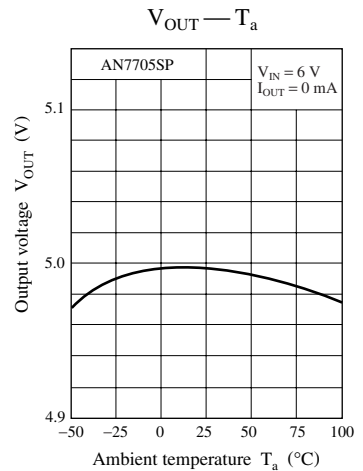
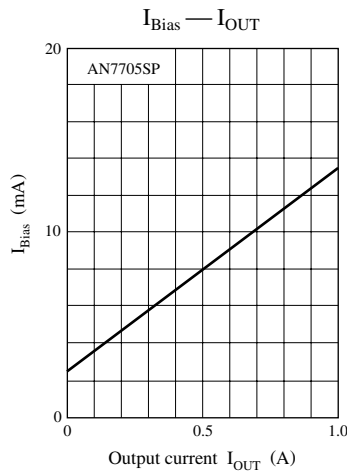
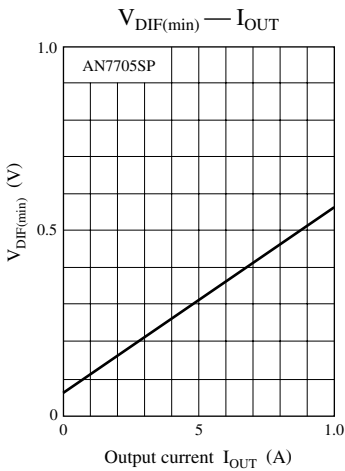
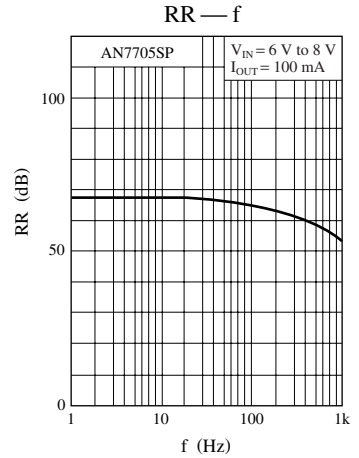
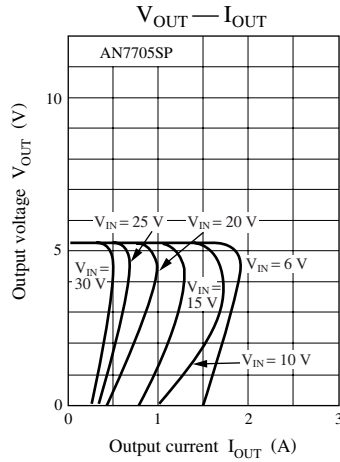
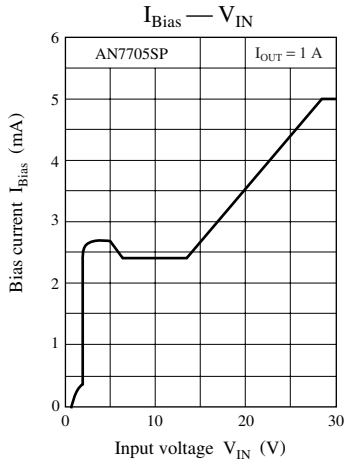
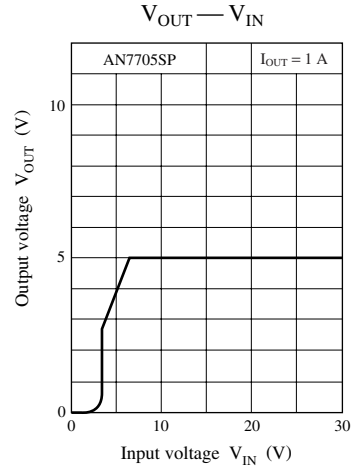

Request for your special attention and precautions in using the technical information and semiconductors described in this material

- (1) An export permit needs to be obtained from the competent authorities of the Japanese Government if any of the products or technologies described in this material and controlled under the "Foreign Exchange and Foreign Trade Law" is to be exported or taken out of Japan.
- (2) The technical information described in this material is limited to showing representative characteristics and applied circuit examples of the products. It does not constitute the warranting of industrial property, the granting of relative rights, or the granting of any license.
- (3) The products described in this material are intended to be used for standard applications or general electronic equipment (such as office equipment, communications equipment, measuring instruments and household appliances).
Consult our sales staff in advance for information on the following applications:
 - Special applications (such as for airplanes, aerospace, automobiles, traffic control equipment, combustion equipment, life support systems and safety devices) in which exceptional quality and reliability are required, or if the failure or malfunction of the products may directly jeopardize life or harm the human body.
 - Any applications other than the standard applications intended.
- (4) The products and product specifications described in this material are subject to change without notice for reasons of modification and/or improvement. At the final stage of your design, purchasing, or use of the products, therefore, ask for the most up-to-date Product Standards in advance to make sure that the latest specifications satisfy your requirements.
- (5) When designing your equipment, comply with the guaranteed values, in particular those of maximum rating, the range of operating power supply voltage and heat radiation characteristics. Otherwise, we will not be liable for any defect which may arise later in your equipment.
Even when the products are used within the guaranteed values, redundant design is recommended, so that such equipment may not violate relevant laws or regulations because of the function of our products.
- (6) When using products for which dry packing is required, observe the conditions (including shelf life and after-unpacking standby time) agreed upon when specification sheets are individually exchanged.
- (7) No part of this material may be reprinted or reproduced by any means without written permission from our company.

Please read the following notes before using the datasheets

- A. These materials are intended as a reference to assist customers with the selection of Panasonic semiconductor products best suited to their applications.
Due to modification or other reasons, any information contained in this material, such as available product types, technical data, and so on, is subject to change without notice.
Customers are advised to contact our semiconductor sales office and obtain the latest information before starting precise technical research and/or purchasing activities.
- B. Panasonic is endeavoring to continually improve the quality and reliability of these materials but there is always the possibility that further rectifications will be required in the future. Therefore, Panasonic will not assume any liability for any damages arising from any errors etc. that may appear in this material.
- C. These materials are solely intended for a customer's individual use.
Therefore, without the prior written approval of Panasonic, any other use such as reproducing, selling, or distributing this material to a third party, via the Internet or in any other way, is prohibited.