

NTZD3155C

Small Signal MOSFET

Complementary 20 V, 540 mA / -430 mA,
with ESD protection, SOT-563 package.

Features

- Leading Trench Technology for Low $R_{DS(on)}$ Performance
- High Efficiency System Performance
- Low Threshold Voltage
- ESD Protected Gate
- Small Footprint 1.6 x 1.6 mm
- These Devices are Pb-Free, Halogen Free/BFR Free and are RoHS Compliant

Applications

- DC-DC Conversion Circuits
- Load/Power Switching with Level Shift
- Single or Dual Cell Li-Ion Battery Operated Systems
- High Speed Circuits
- Cell Phones, MP3s, Digital Cameras, and PDAs

MAXIMUM RATINGS ($T_J = 25^\circ\text{C}$ unless otherwise specified)

Parameter		Symbol	Value	Unit	
Drain-to-Source Voltage		V_{DSS}	20	V	
Gate-to-Source Voltage		V_{GS}	± 6	V	
N-Channel Continuous Drain Current (Note 1)	Steady State	$T_A = 25^\circ\text{C}$	540	I_D mA	
		$T_A = 85^\circ\text{C}$	390		
	$t \leq 5$ s	$T_A = 25^\circ\text{C}$	570		
P-Channel Continuous Drain Current (Note 1)	Steady State	$T_A = 25^\circ\text{C}$	-430		
		$T_A = 85^\circ\text{C}$	-310		
	$t \leq 5$ s	$T_A = 25^\circ\text{C}$	-455		
Power Dissipation (Note 1)	Steady State	$T_A = 25^\circ\text{C}$	P_D	250	mW
			$t \leq 5$ s	280	
Pulsed Drain Current	N-Channel	$t_p = 10 \mu\text{s}$	I_{DM}	1500	mA
	P-Channel			-750	
Operating Junction and Storage Temperature		T_J, T_{STG}	-55 to 150	$^\circ\text{C}$	
Source Current (Body Diode)		I_S	350	mA	
Lead Temperature for Soldering Purposes (1/8" from case for 10 s)		T_L	260	$^\circ\text{C}$	

Stresses exceeding those listed in the Maximum Ratings table may damage the device. If any of these limits are exceeded, device functionality should not be assumed, damage may occur and reliability may be affected.

1. Surface-mounted on FR4 board using 1 in sq. pad size (Cu area = 1.127 in sq [1 oz] including traces).



ON Semiconductor®

www.onsemi.com

$V_{(BR)DSS}$	$R_{DS(on)}$ Typ	I_D Max (Note 1)
N-Channel 20 V	0.4 Ω @ 4.5 V	540 mA
	0.5 Ω @ 2.5 V	
	0.7 Ω @ 1.8 V	
P-Channel -20 V	0.5 Ω @ -4.5 V	-430 mA
	0.6 Ω @ -2.5 V	
	1.0 Ω @ -1.8 V	

PINOUT: SOT-563

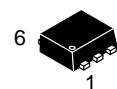
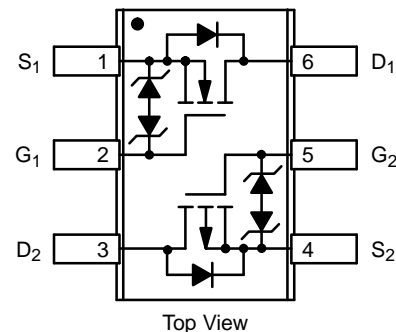

SOT-563-6
CASE 463A

MARKING DIAGRAM



TW = Specific Device Code
M = Date Code
▪ = Pb-Free Package

(Note: Microdot may be in either location)

ORDERING INFORMATION

Device	Package	Shipping†
NTZD3155CT1G	SOT-563 (Pb-Free)	4000 / Tape & Reel
NTZD3155CT2G		
NTZD3155CT5G		8000 / Tape & Reel

†For information on tape and reel specifications, including part orientation and tape sizes, please refer to our Tape and Reel Packaging Specifications Brochure, BRD8011/D.

NTZD3155C

Thermal Resistance Ratings

Parameter	Symbol	Max	Unit
Junction-to-Ambient – Steady State (Note 2)	$R_{\theta JA}$	500	$^{\circ}\text{C/W}$
Junction-to-Ambient – $t = 5$ s (Note 2)		447	

2. Surface mounted on FR4 board using 1 in sq pad size (Cu area = 1.127 in sq [1 oz] including traces).

ELECTRICAL CHARACTERISTICS ($T_J = 25^{\circ}\text{C}$ unless otherwise specified)

Parameter	Symbol	N/P	Test Condition	Min	Typ	Max	Unit
OFF CHARACTERISTICS							
Drain-to-Source Breakdown Voltage	$V_{(BR)DSS}$	N	$V_{GS} = 0\text{ V}$	$I_D = 250\ \mu\text{A}$	20		V
		P		$I_D = -250\ \mu\text{A}$	-20		
Drain-to-Source Breakdown Voltage Temperature Coefficient	$V_{(BR)DSS}/T_J$				18		$\text{mV}/^{\circ}\text{C}$
Zero Gate Voltage Drain Current	I_{DSS}	N	$V_{GS} = 0\text{ V}, V_{DS} = 16\text{ V}$	$T_J = 25^{\circ}\text{C}$		1.0	μA
		P	$V_{GS} = 0\text{ V}, V_{DS} = -16\text{ V}$			-1.0	
		N	$V_{GS} = 0\text{ V}, V_{DS} = 16\text{ V}$	$T_J = 125^{\circ}\text{C}$		2.0	μA
		P	$V_{GS} = 0\text{ V}, V_{DS} = -16\text{ V}$			-5.0	
Gate-to-Source Leakage Current	I_{GSS}	P	$V_{DS} = 0\text{ V}, V_{GS} = \pm 4.5\text{ V}$			± 2.0	μA
		N				± 5.0	

ON CHARACTERISTICS (Note 3)

Gate Threshold Voltage	$V_{GS(TH)}$	N	$V_{GS} = V_{DS}$	$I_D = 250\ \mu\text{A}$	0.45		1.0	V
		P		$I_D = -250\ \mu\text{A}$	-0.45		-1.0	
Gate Threshold Temperature Coefficient	$V_{GS(TH)}/T_J$					-1.9		$-\text{mV}/^{\circ}\text{C}$
Drain-to-Source On Resistance	$R_{DS(on)}$	N	$V_{GS} = 4.5\text{ V}, I_D = 540\text{ mA}$			0.4	0.55	Ω
		P	$V_{GS} = -4.5\text{ V}, I_D = -430\text{ mA}$			0.5	0.9	
		N	$V_{GS} = 2.5\text{ V}, I_D = 500\text{ mA}$			0.5	0.7	
		P	$V_{GS} = -2.5\text{ V}, I_D = -300\text{ mA}$			0.6	1.2	
		N	$V_{GS} = 1.8\text{ V}, I_D = 350\text{ mA}$			0.7	0.9	
		P	$V_{GS} = -1.8\text{ V}, I_D = -150\text{ mA}$			1.0	2.0	
Forward Transconductance	g_{FS}	N	$V_{DS} = 10\text{ V}, I_D = 540\text{ mA}$			1.0		S
		P	$V_{DS} = -10\text{ V}, I_D = -430\text{ mA}$			1.0		

CHARGES, CAPACITANCES AND GATE RESISTANCE

Input Capacitance	C_{ISS}	N	$f = 1\text{ MHz}, V_{GS} = 0\text{ V}$ $V_{DS} = 16\text{ V}$		80	150	pF
Output Capacitance	C_{OSS}				13	25	
Reverse Transfer Capacitance	C_{RSS}				10	20	
Input Capacitance	C_{ISS}	P	$f = 1\text{ MHz}, V_{GS} = 0\text{ V}$ $V_{DS} = -16\text{ V}$		105	175	
Output Capacitance	C_{OSS}				15	30	
Reverse Transfer Capacitance	C_{RSS}				10	20	

3. Pulse Test: pulse width $\leq 300\ \mu\text{s}$, duty cycle $\leq 2\%$

Product parametric performance is indicated in the Electrical Characteristics for the listed test conditions, unless otherwise noted. Product performance may not be indicated by the Electrical Characteristics if operated under different conditions.

NTZD3155C

ELECTRICAL CHARACTERISTICS (T_J = 25°C unless otherwise specified)

Parameter	Symbol	N/P	Test Condition	Min	Typ	Max	Unit
-----------	--------	-----	----------------	-----	-----	-----	------

CHARGES, CAPACITANCES AND GATE RESISTANCE

Total Gate Charge	Q _{G(TOT)}	N	V _{GS} = 4.5 V, V _{DS} = -10 V; I _D = 540 mA		1.5	2.5	nC
Threshold Gate Charge	Q _{G(TH)}				0.1		
Gate-to-Source Charge	Q _{GS}				0.2		
Gate-to-Drain Charge	Q _{GD}				0.35		
Total Gate Charge	Q _{G(TOT)}	P	V _{GS} = -4.5 V, V _{DS} = 10 V; I _D = -380 mA		1.7	2.5	
Threshold Gate Charge	Q _{G(TH)}				0.1		
Gate-to-Source Charge	Q _{GS}				0.3		
Gate-to-Drain Charge	Q _{GD}				0.4		

SWITCHING CHARACTERISTICS (V_{GS} = V) (Note 4)

Turn-On Delay Time	t _{d(ON)}	N	V _{GS} = 4.5 V, V _{DD} = -10 V, I _D = 540 mA, R _G = 10 Ω		6.0		ns
Rise Time	t _r				4.0		
Turn-Off Delay Time	t _{d(OFF)}				16		
Fall Time	t _f				8.0		
Turn-On Delay Time	t _{d(ON)}	P	V _{GS} = -4.5 V, V _{DD} = 10 V, I _D = -215 mA, R _G = 10 Ω		10		
Rise Time	t _r				12		
Turn-Off Delay Time	t _{d(OFF)}				35		
Fall Time	t _f				19		

Drain-Source Diode Characteristics

Forward Diode Voltage	V _{SD}	N	V _{GS} = 0 V, T _J = 25°C	I _S = 350 mA		0.7	1.2	V
		P		I _S = -350 mA		-0.8	-1.2	
Reverse Recovery Time	t _{RR}	N	V _{GS} = 0 V, dI _S /dt = 100 A/μs	I _S = 350 mA		6.5		ns
		P		I _S = -350 mA		13		

4. Switching characteristics are independent of operating junction temperatures

NTZD3155C

N-CHANNEL TYPICAL PERFORMANCE CURVES ($T_J = 25^\circ\text{C}$ unless otherwise noted)

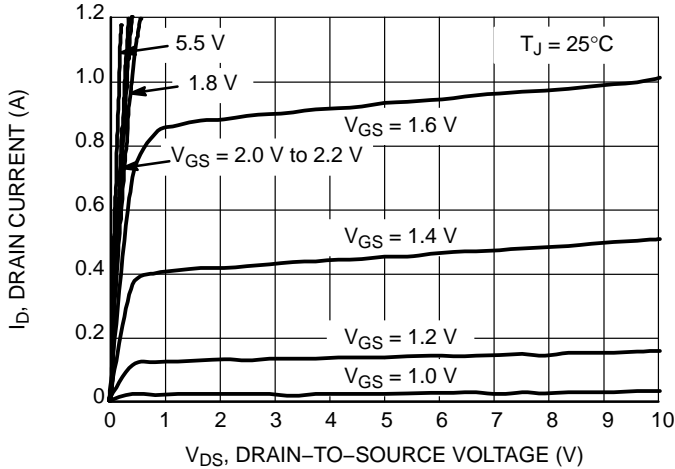

Figure 1. On-Region Characteristics

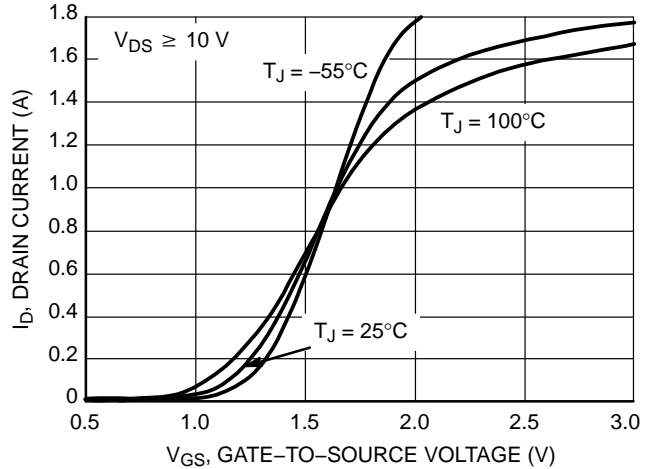

Figure 2. Transfer Characteristics

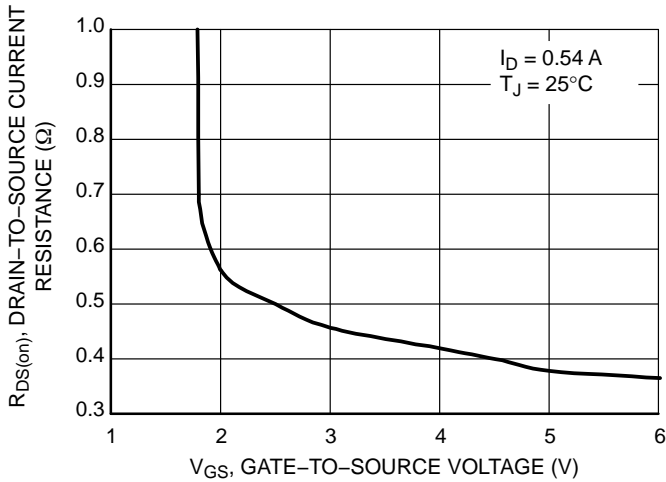

Figure 3. On-Resistance versus Gate-to-Source Voltage

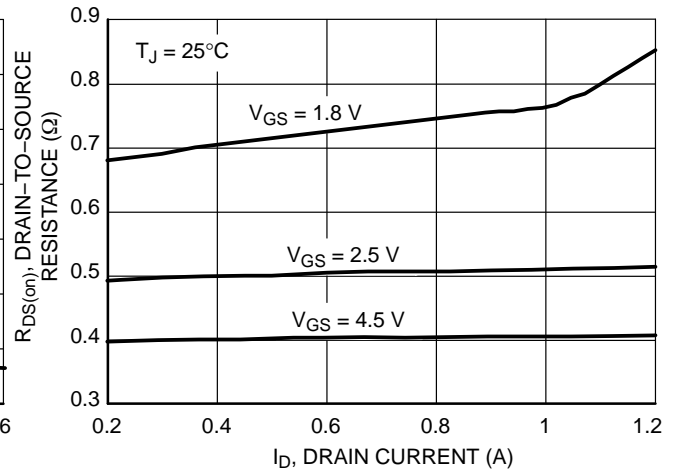

Figure 4. On-Resistance versus Drain Current and Gate Voltage

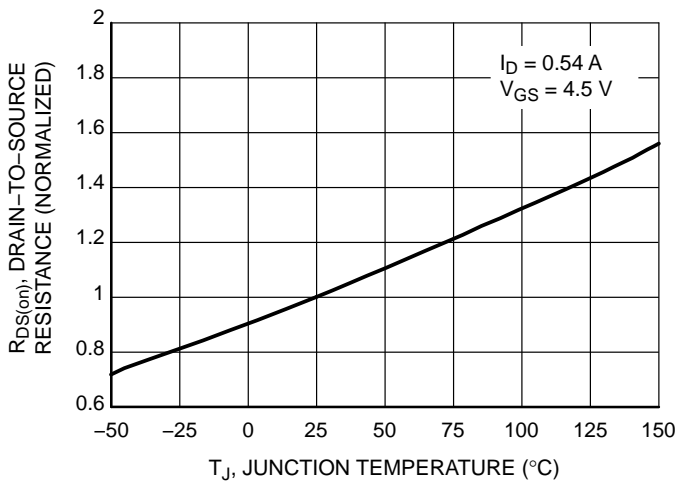

Figure 5. On-Resistance Variation with Temperature

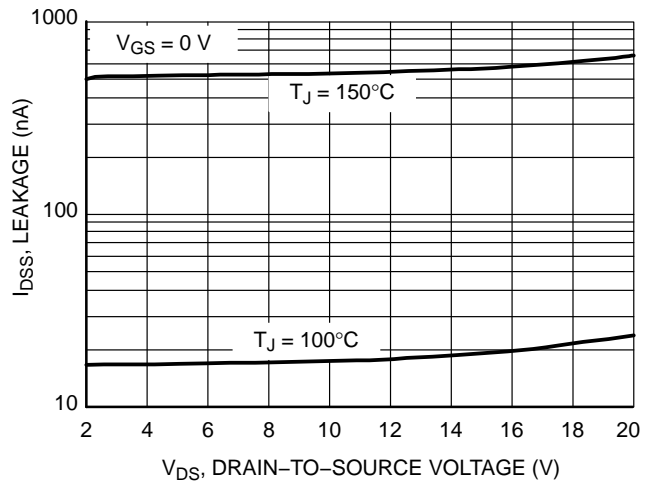

Figure 6. Drain-to-Source Leakage Current versus Voltage

NTZD3155C

N-CHANNEL TYPICAL PERFORMANCE CURVES ($T_J = 25^\circ\text{C}$ unless otherwise noted)

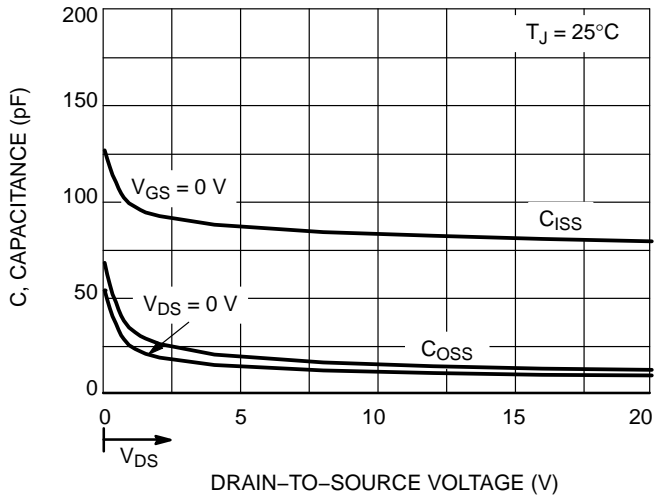

Figure 7. Capacitance Variation

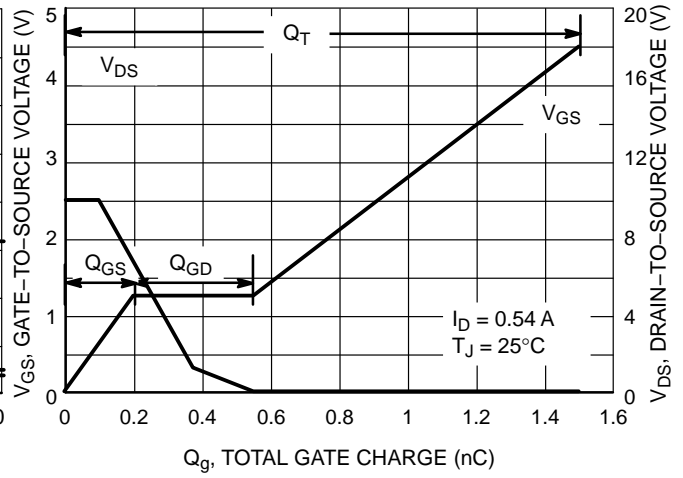

Figure 8. Gate-to-Source and Drain-to-Source Voltage versus Total Charge

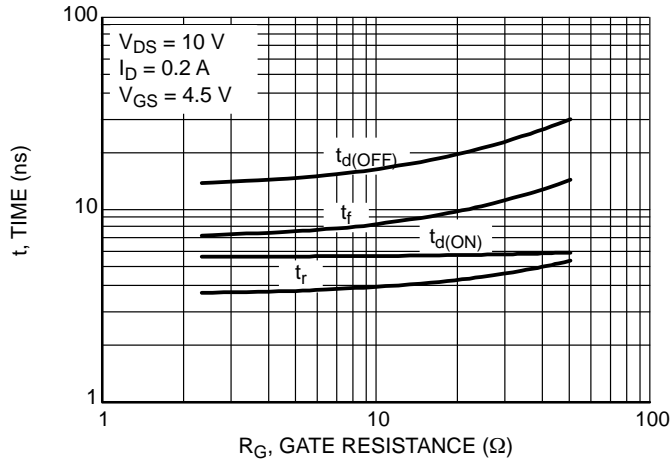

Figure 9. Resistive Switching Time Variation versus Gate Resistance

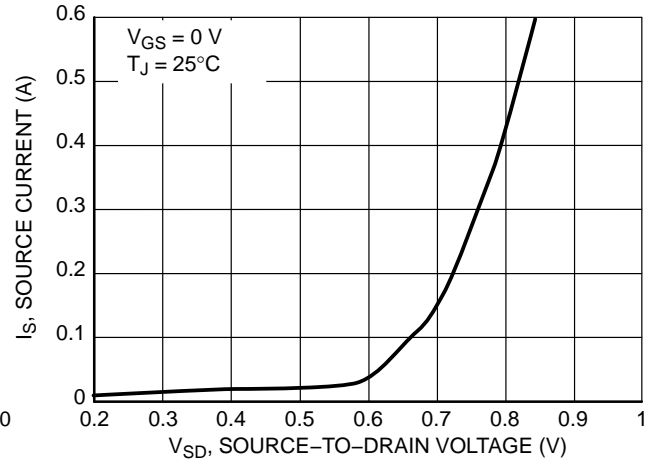

Figure 10. Diode Forward Voltage versus Current

NTZD3155C

P-CHANNEL TYPICAL PERFORMANCE CURVES ($T_J = 25^\circ\text{C}$ unless otherwise noted)

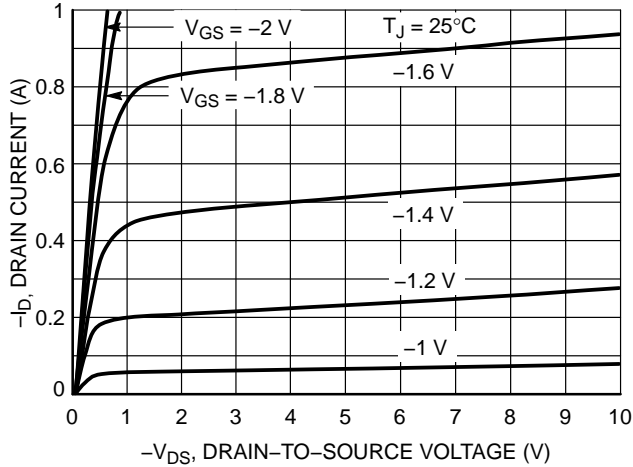

Figure 1. On-Region Characteristics

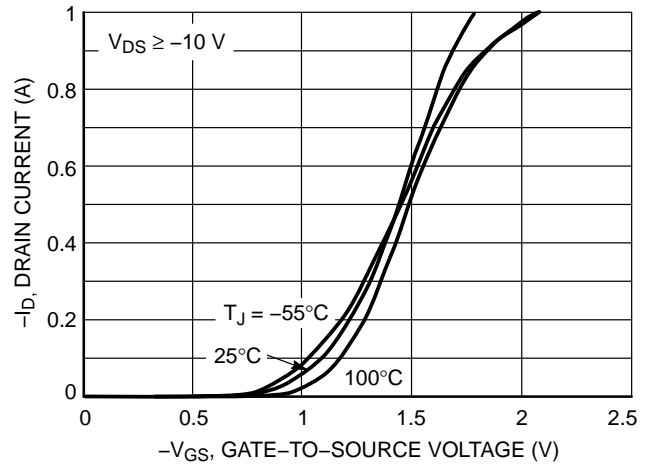

Figure 2. Transfer Characteristics

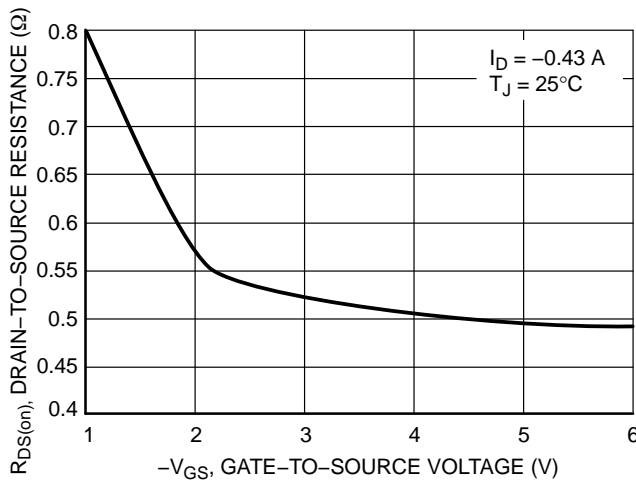

Figure 3. On-Resistance vs. Gate-to-Source Voltage

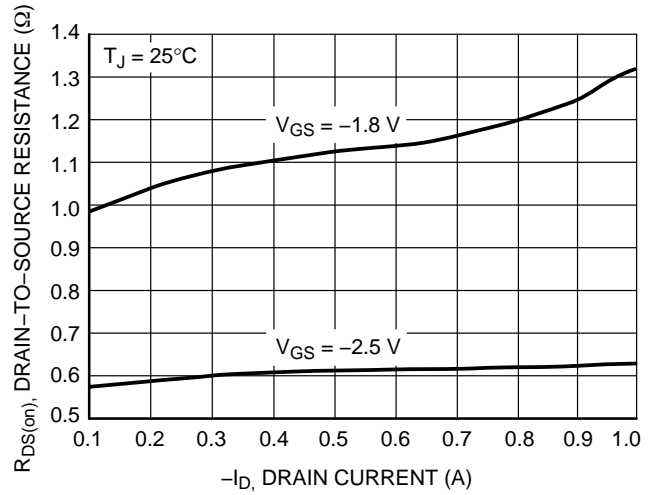

Figure 4. On-Resistance vs. Drain Current and Gate Voltage

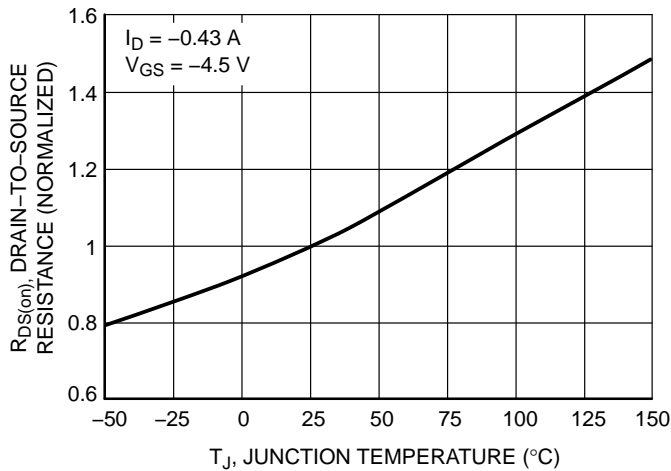

Figure 5. On-Resistance Variation with Temperature

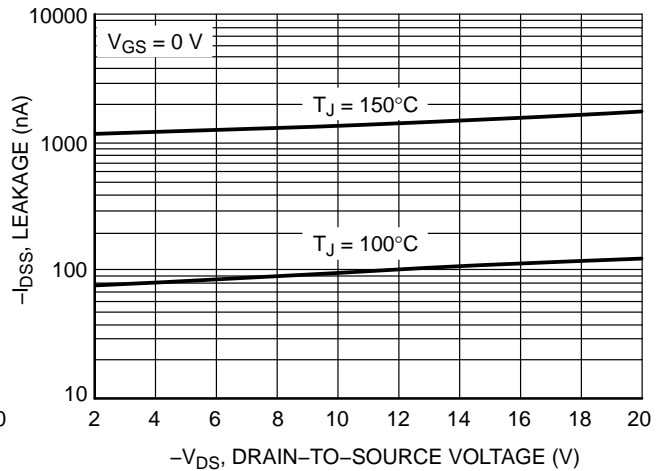

Figure 6. Drain-to-Source Leakage Current vs. Voltage

NTZD3155C

P-CHANNEL TYPICAL PERFORMANCE CURVES ($T_J = 25^\circ\text{C}$ unless otherwise noted)

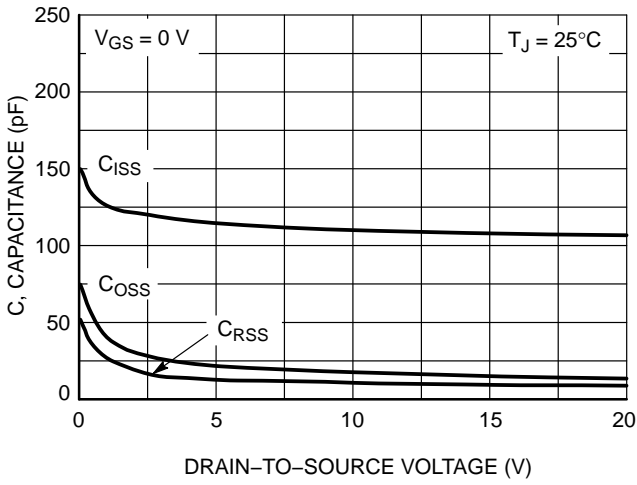

Figure 7. Capacitance Variation

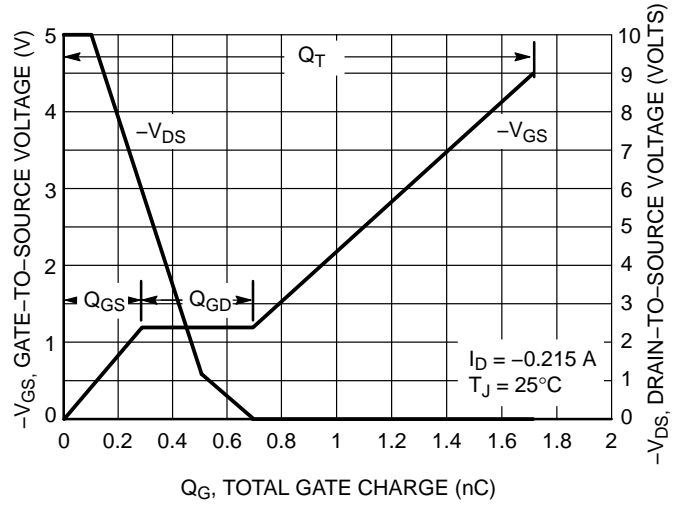

Figure 8. Gate-to-Source and Drain-to-Source Voltage vs. Total Charge

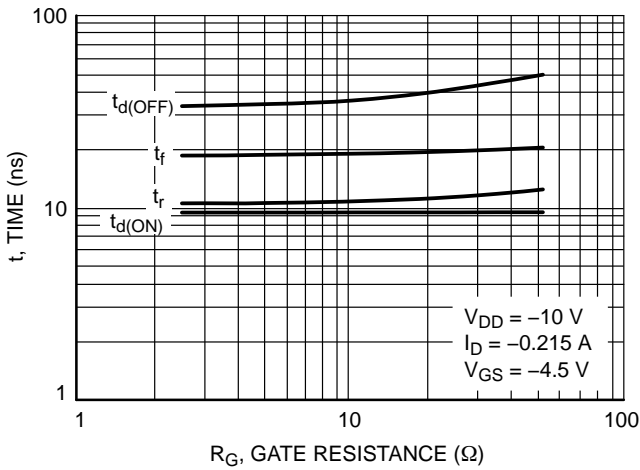

Figure 9. Resistive Switching Time Variation vs. Gate Resistance

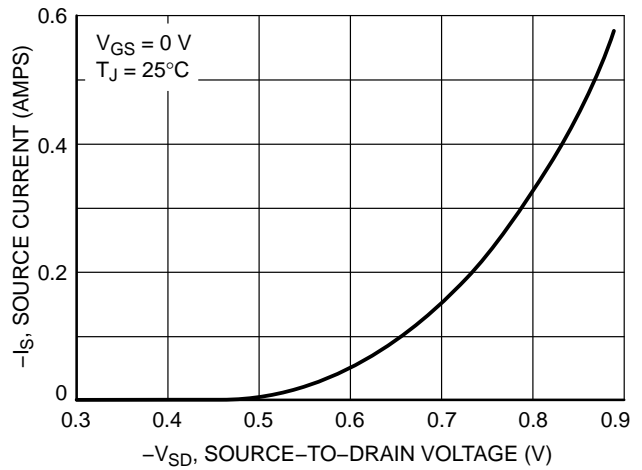
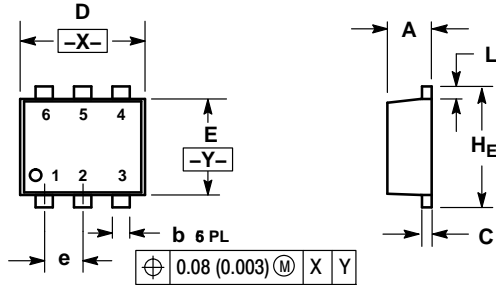

Figure 10. Diode Forward Voltage vs. Current

NTZD3155C

PACKAGE DIMENSIONS

SOT-563, 6 LEAD CASE 463A ISSUE F



NOTES:

1. DIMENSIONING AND TOLERANCING PER ANSI Y14.5M, 1982.
2. CONTROLLING DIMENSION: MILLIMETERS
3. MAXIMUM LEAD THICKNESS INCLUDES LEAD FINISH THICKNESS. MINIMUM LEAD THICKNESS IS THE MINIMUM THICKNESS OF BASE MATERIAL.

DIM	MILLIMETERS			INCHES		
	MIN	NOM	MAX	MIN	NOM	MAX
A	0.50	0.55	0.60	0.020	0.021	0.023
b	0.17	0.22	0.27	0.007	0.009	0.011
C	0.08	0.12	0.18	0.003	0.005	0.007
D	1.50	1.60	1.70	0.059	0.062	0.066
E	1.10	1.20	1.30	0.043	0.047	0.051
e	0.5 BSC			0.02 BSC		
L	0.10	0.20	0.30	0.004	0.008	0.012
HE	1.50	1.60	1.70	0.059	0.062	0.066

SOLDERING FOOTPRINT*

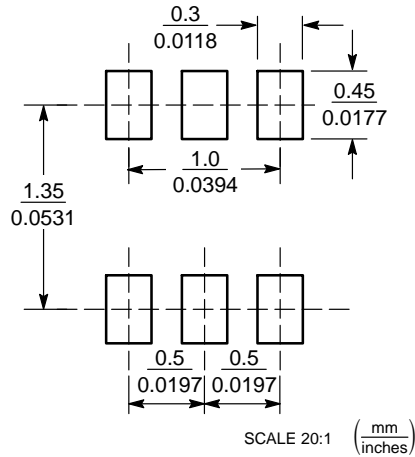

*For additional information on our Pb-Free strategy and soldering details, please download the ON Semiconductor Soldering and Mounting Techniques Reference Manual, SOLDERRM/D.

ON Semiconductor and the are registered trademarks of Semiconductor Components Industries, LLC (SCILLC) or its subsidiaries in the United States and/or other countries. SCILLC owns the rights to a number of patents, trademarks, copyrights, trade secrets, and other intellectual property. A listing of SCILLC's product/patent coverage may be accessed at www.onsemi.com/site/pdf/Patent-Marking.pdf. SCILLC reserves the right to make changes without further notice to any products herein. SCILLC makes no warranty, representation or guarantee regarding the suitability of its products for any particular purpose, nor does SCILLC assume any liability arising out of the application or use of any product or circuit, and specifically disclaims any and all liability, including without limitation special, consequential or incidental damages. "Typical" parameters which may be provided in SCILLC data sheets and/or specifications can and do vary in different applications and actual performance may vary over time. All operating parameters, including "Typicals" must be validated for each customer application by customer's technical experts. SCILLC does not convey any license under its patent rights nor the rights of others. SCILLC products are not designed, intended, or authorized for use as components in systems intended for surgical implant into the body, or other applications intended to support or sustain life, or for any other application in which the failure of the SCILLC product could create a situation where personal injury or death may occur. Should Buyer purchase or use SCILLC products for any such unintended or unauthorized application, Buyer shall indemnify and hold SCILLC and its officers, employees, subsidiaries, affiliates, and distributors harmless against all claims, costs, damages, and expenses, and reasonable attorney fees arising out of, directly or indirectly, any claim of personal injury or death associated with such unintended or unauthorized use, even if such claim alleges that SCILLC was negligent regarding the design or manufacture of the part. SCILLC is an Equal Opportunity/Affirmative Action Employer. This literature is subject to all applicable copyright laws and is not for resale in any manner.

PUBLICATION ORDERING INFORMATION

LITERATURE FULFILLMENT:

Literature Distribution Center for ON Semiconductor
P.O. Box 5163, Denver, Colorado 80217 USA
Phone: 303-675-2175 or 800-344-3860 Toll Free USA/Canada
Fax: 303-675-2176 or 800-344-3867 Toll Free USA/Canada
Email: orderlit@onsemi.com

N. American Technical Support: 800-282-9855 Toll Free
USA/Canada
Europe, Middle East and Africa Technical Support:
Phone: 421 33 790 2910
Japan Customer Focus Center
Phone: 81-3-5817-1050

ON Semiconductor Website: www.onsemi.com

Order Literature: <http://www.onsemi.com/orderlit>

For additional information, please contact your local Sales Representative