

USE WITH AMT23118DA DIE ASSEMBLY.

# AMT23133L-ENV

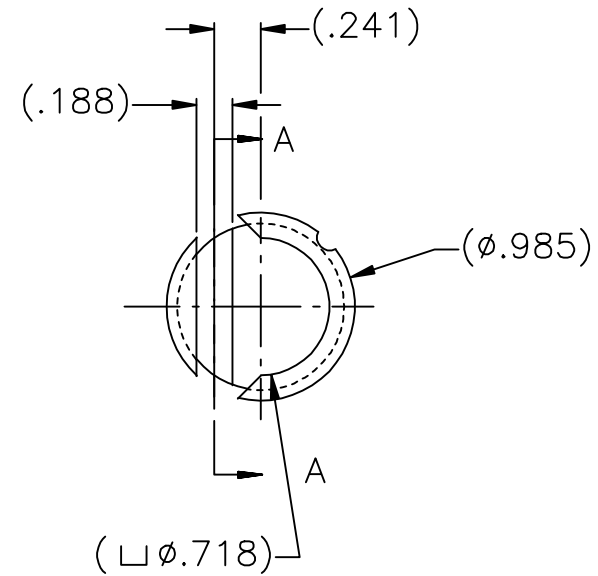
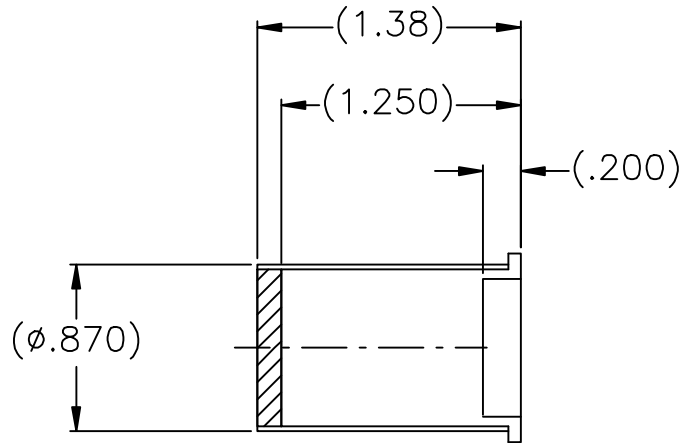

**UNCONTROLLED DOCUMENT**  
**WILL NOT BE UPDATED**

2. MAT'L: REF. 2024 ALUM.

NOTES: 1. THIS IS AN AUTOCAD DRAWING, DO NOT CHANGE MANUALLY.

				<p>THESE DRAWINGS, SPECIFICATIONS OR OTHER DATA ARE AND REMAIN, THE PROPERTY OF ASTRO TOOL CORP. AND MUST BE RETURNED UPON REQUEST. THEY CONTAIN INFORMATION OWNED AND/OR DEVELOPED BY ASTRO AT ITS OWN PRIVATE EXPENSE AND MAY NOT BE USED, DUPLICATED OR DISCLOSED TO OTHERS, IN WHOLE OR IN PART FOR DESIGN, MANUFACTURE OR PROCUREMENT WITHOUT THE WRITTEN PERMISSION OF ASTRO TOOL CORP. EACH AND EVERY TIME.</p>	<p>SCALE: N.T.S.</p>	<p>UNLESS OTHERWISE SPECIFIED: DECIMALS: .XXX ± .005 .XX ± .010 .X ± .030</p>	<p>ASTRO TOOL CORP. 21615 S.W. TUALATIN VALLEY HWY., BEAVERTON OR 97006</p>	CAGE 58164	
A	NEW RELEASE.	DYO	12-17-13	MMK	<p>DWN BY: DYO</p>			<p>DATE: 12-17-13</p>	<p>DESCRIPTION: ENVELOPE DRAWING: AMT23133L LOCATOR, 0 GAGE</p>
REV.	DESCRIPTION	BY	DATE	APR.	APPROVED:	ANGLES: ± 1°	PART NO.	A	AMT23133L-ENV