

NOTES:

1. ROHS COMPLIANT
2. HEADER: THERMOSET PLASTIC MATERIAL WITH FLAMMABILITY RATING UL 94V-0 OR BETTER.
3. STORAGE TEMPERATURE: -50°C TO +125°C
4. COMPLIANCE TO J-STD:
 - A. J-STD-002: SOLDERABILITY AT 245°C REFLOW PROFILE
 - B. J-STD-020: LEVEL 1, NO MOISTURE SENSITIVE
 - C. J-STD-075: R7, 245°C MAXIMUM THROUGH REFLOW SOLDER
5. TO ORDER TAPE & REEL PACKAGING ADD A "T" SUFFIX TO THE PART NUMBER(i.e HX5008NL BECOMES HX5008NLT).

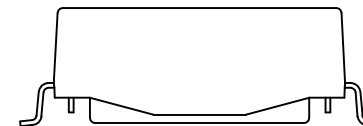
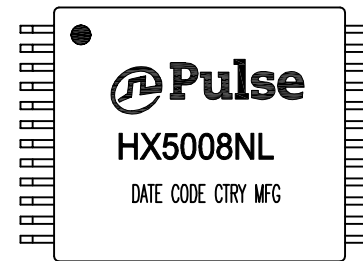

FINAL OUTLINE

© Copyright, 2015. Pulse Electronics Corp. All rights reserved. Pulse confidential & proprietary. (07/30/15)

PRODUCT DESCRIPTION	TLA DRAWING	PS DRAWING	SHEET	PART NO.	DATASHEET REV.
MDL,SIN,1GD,1:1,SM,OH	HX5008NL-14	PS-0118.001-D	1 OF 3	HX5008NL	A

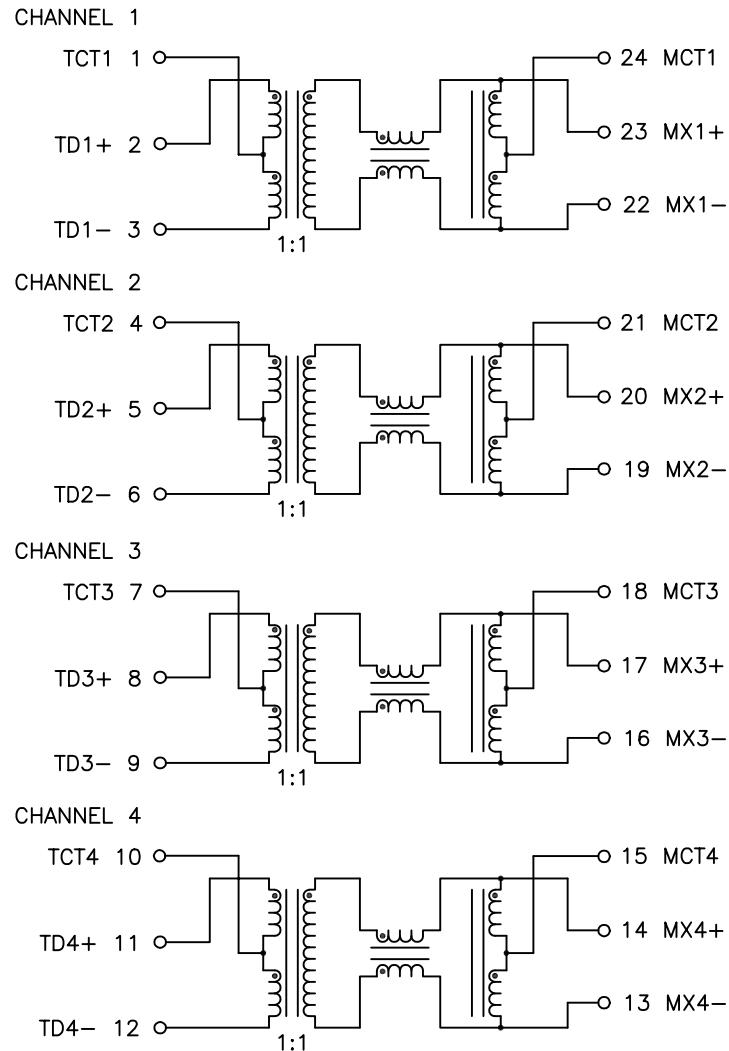

SCHEMATIC

ELECTRICAL CHARACTERISTICS AT +25°C UNLESS OTHER SPECIFIED
MEETS IEEE 802.3 SPECIFICATION

PARAMETER	SPECIFICATIONS		
OPERATING TEMP	-40°C - +85 °C		
TURNS RATIO	1 : 1 ±2%		
POLARITY	PER SCHEMATIC		
OCL, TRANSMIT CHANNEL	325 uh MIN. WITH 8mA DC BIAS, -40 TO 85 °C		
INSERTION LOSS	100 KHz	1-100 MHz	125 MHz
	-1.2 dB MAX	-1.0 dB MAX	-3.0 dB MAX
RETURN LOSS (Z OUT = 100 OHM ±15%)	1-40 MHz	40-100 MHz	
	-16 dB MIN	-10+20*LOG ₁₀ (f/80) dB MIN	
CROSSTALK (TX-RX)	1 MHz	30-100 MHz	
	-50 dB MIN	-55+24*LOG ₁₀ (f/10) dB MIN	
DIFFERENTIAL TO COMMON MODE REJECTION	2 MHz	30-100 MHz	
	-50 dB MIN	-43+22*LOG ₁₀ (f/30) dB MIN	
INPUT - OUTPUT ISOLATION	1500 VRMS MIN		

NOTE: f IS FREQUENCY IN MHZ.

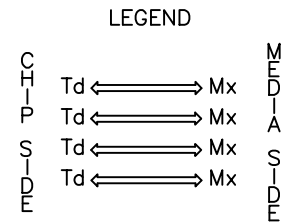

ALL CHANNELS ARE
IN PHASE BETWEEN
INPUT AND OUTPUT

© Copyright, 2015. Pulse Electronics Corp. All rights reserved. Pulse confidential & proprietary. (07/30/15)

PRODUCT DESCRIPTION	TLA DRAWING	PS DRAWING	SHEET	PART NO.	DATASHEET REV.
MDL,SIN,1GD,1:1,SM,OH	HX5008NL-14	PS-0118.001-D	2 OF 3	HX5008NL	A

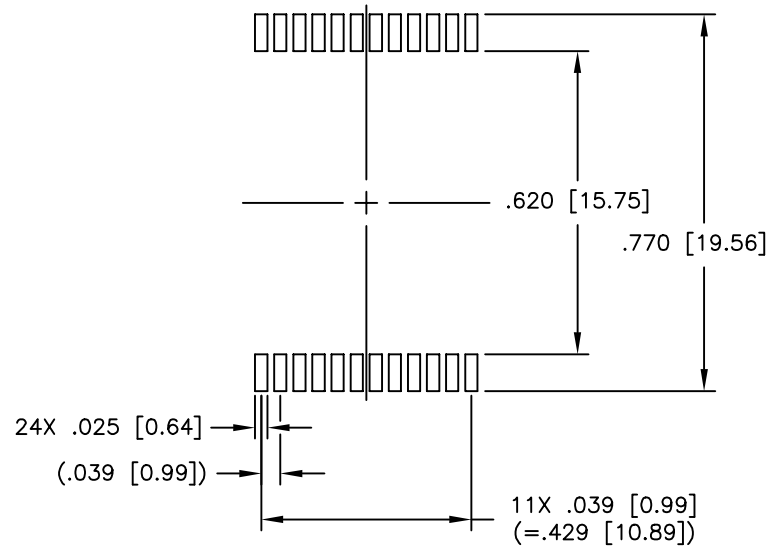
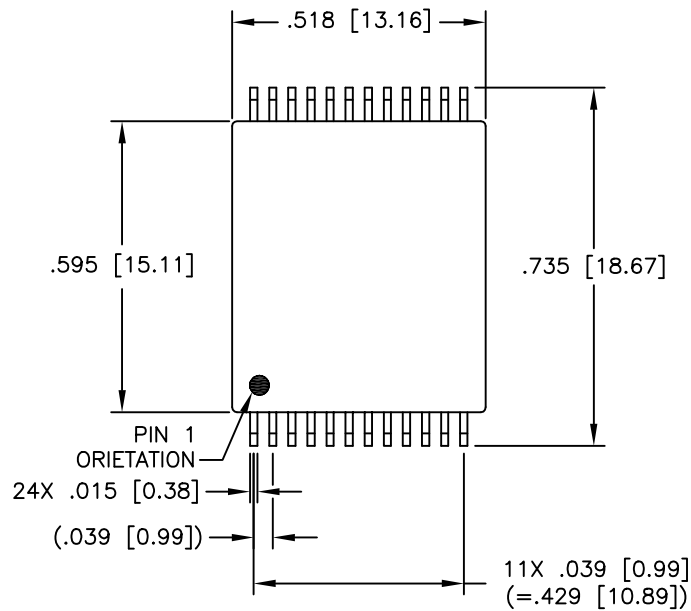

SUGGESTED LAND PATTERN

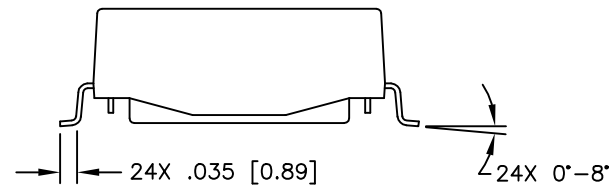
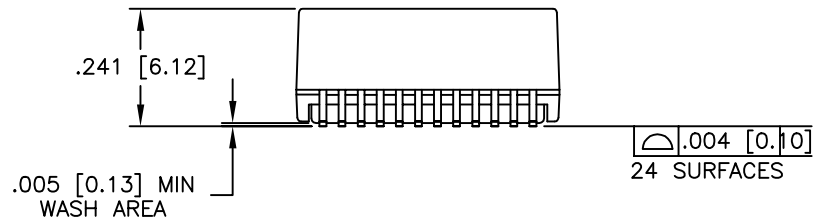

DIMENSIONS ARE IN INCHES [MILLIMETERS] WITH THE FOLLOWING
TOLERANCES: [MILLIMETERS] ARE FOR REFERENCE ONLY.
.XX= ±.02 [±0.5]
.XXX= ±.010 [±0.25]

© Copyright, 2015. Pulse Electronics Corp. All rights reserved. Pulse confidential & proprietary. (07/30/15)

PRODUCT DESCRIPTION	TLA DRAWING	PS DRAWING	SHEET	PART NO.	DATASHEET REV.
MDL,SIN,1GD,1:1,SM,OH	HX5008NL-14	PS-0118.001-D	3 OF 3	HX5008NL	A