

General Specifications

Electrical Capacity (Resistive Load)

Logic Level: 0.4VA maximum @ 28V AC/DC maximum
(Applicable Range 0.1mA ~ 0.1A @ 20mV ~ 28V)
Note: Find additional explanation of operating range in Supplement section.

Other Ratings

Contact Resistance: 50 milliohms maximum
Insulation Resistance: 500 megohms minimum @ 500V DC
Dielectric Strength: 500V AC minimum for 1 minute minimum
Mechanical Life: 100,000 operations minimum
Electrical Life: 50,000 operations minimum
Nominal Operating Force: 1.18N
Contact Timing: Nonshorting (break-before-make)
Angle of Throw: 26°

Materials & Finishes

Actuator: Polyamide
Bushing Housing: Polyamide
Case Housing: Glass fiber reinforced polyamide
Support Bracket: Phosphor bronze with tin plating
Movable Contact: Phosphor bronze with gold plating
Stationary Contacts: Brass with tin plating
Terminals: Brass with gold plating

Environmental Data

Operating Temperature Range: -25°C through +55°C (-13°F through +131°F)
Humidity: 90 ~ 95% humidity for 240 hours @ 40°C (104°F)
Vibration: 10 ~ 55Hz with peak-to-peak amplitude of 1.5mm traversing the frequency range & returning in 5 minutes; 3 right angled directions for 2 hours
Shock: 50G (490m/s²) acceleration (tested in 3 right angled directions, with 5 shocks in each direction)

PCB Processing

Soldering: Wave Soldering recommended. See Profile A in Supplement section.
Manual Soldering: See Profile A in Supplement section.
Cleaning: Automated alcohol based cleaning recommended, 5 minutes maximum. Do not use high-purity alcohol (50% alcohol or more) or organic solvent. High alcohol solution can damage clear plastic. See Cleaning specifications in Supplement section.

Standards & Certifications

The B Series illuminated toggles have not been tested for UL recognition or CSA certification. These switches are designed for use in a low-voltage, low-current, logic-level circuit. When used as intended in a logic-level circuit, the results do not produce hazardous energy.

Distinctive Characteristics

LED provides maximum illumination to bushing and actuator, indicating actuator status in highly visible green, red, or amber for single color or red/green for bicolor. (Patent pending.)

Totally sealed body construction prevents contact contamination and allows time- and money-saving automated soldering and cleaning. Molded-in, epoxy sealed terminals lock out flux and other contaminants.

Award-winning STC contact mechanism with benefits unavailable in conventional mechanisms: smoother, positive detent actuation, increased contact stability, and unparalleled logic-level reliability. (Additional STC details in Terms & Acronyms; see Supplement section.)

.100" x .100" (2.54mm x 2.54mm) terminal spacing conforms to standard PC board grid spacing.

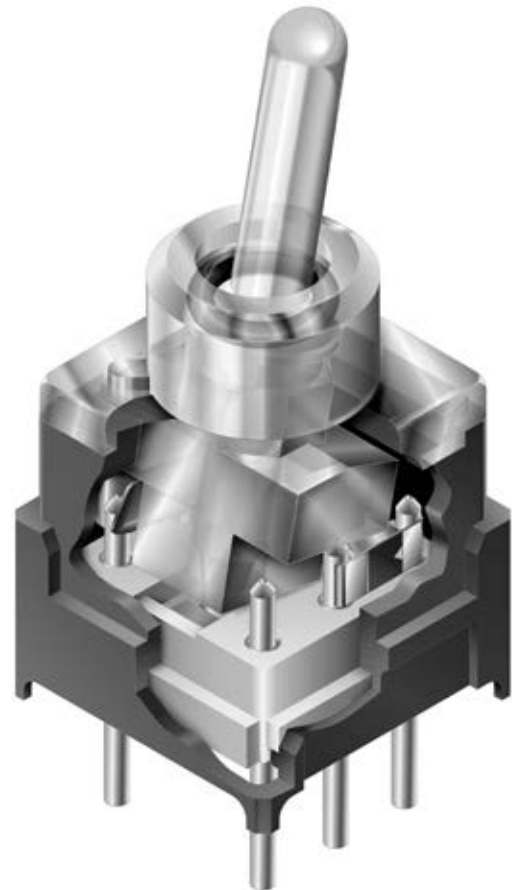

Actual Size

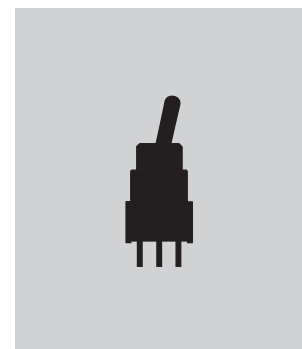

- A Toggles
- Rockers
- Pushbuttons
- Illuminated PB
- Programmable
- Keylocks
- Rotaries
- Slides
- Tactiles
- Tilt
- Touch
- Indicators
- Accessories
- Supplement

Toggles
A

TYPICAL SWITCH ORDERING EXAMPLE

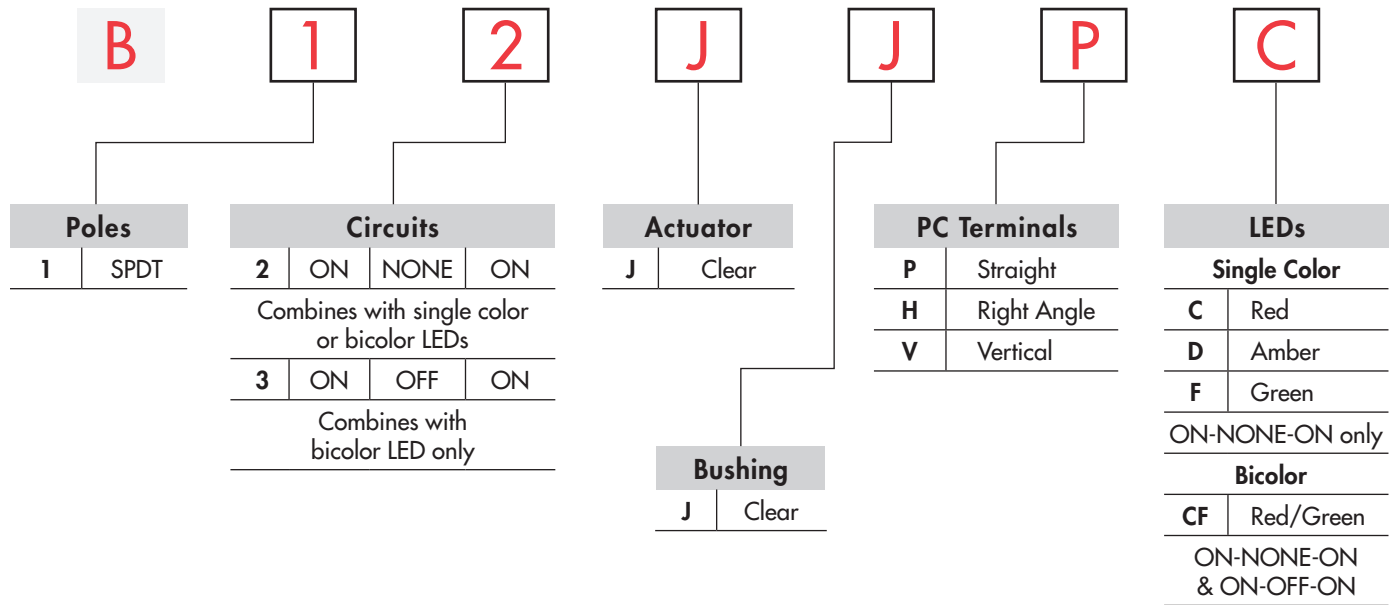

DESCRIPTION FOR TYPICAL ORDERING EXAMPLE

B12JJPC

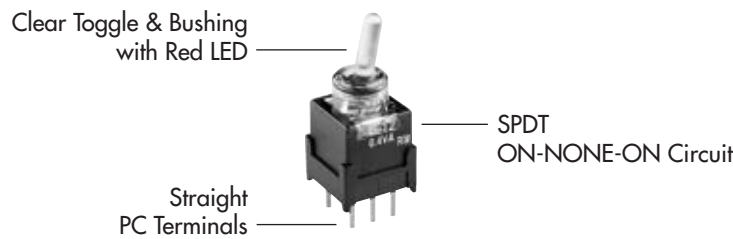

POLE & CIRCUITS

| Pole Throw | Model | Toggle Position | | | Connected Terminals | | | Throw & Schematics |
|------------|--------------------------|-----------------|--------|------|---------------------|--------|------|---|
| | | Up | Center | Down | Up | Center | Down | |
| SPDT | B12 B13 | ON | NONE | ON | 2-3 | NONE | 2-1 | <p>Note: Terminal numbers are not actually on the switch. LED circuit is isolated and requires an external power source.</p> <p>Single Color</p> <p>Bicolor</p> |
| | | ON | OFF | ON | 2-3 | OPEN | 2-1 | |

ACTUATOR & BUSHING

J Clear Toggle

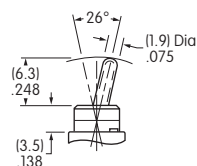

J Clear Bushing

Rockers

Pushbuttons

Illuminated PB

Programmable

Keylocks

Rotaries

Slides

Tactiles

Tilt

Touch

Indicators

Accessories

Supplement

LED COLORS & SPECIFICATIONS

LEDs are an integral part of the switch and not available separately. The electrical specifications shown are determined at a basic temperature of 25°C. If the source voltage exceeds the rated voltage, a ballast resistor is required. The resistor value can be calculated by using the formula in the Supplement section.

| | Colors | Single Color | | | Bicolor |
|-----------------------------------|--------------|-----------------|-------------------|-------------------|------------------------|
| | | C Red | D Amber | F Green | CF Red/Green |
| Maximum Forward Current | I_{FM} | 30mA | 30mA | 25mA | 30mA/25mA |
| Typical Forward Current | I_F | 20mA | 20mA | 20mA | 20mA/20mA |
| Forward Voltage | V_F | 1.95V | 2.0V | 3.3V | 1.95V/3.3V |
| Maximum Reverse Voltage | V_{RM} | 5V | 5V | 5V | 5V/5V |
| Current Reduction Rate Above 25°C | ΔI_F | 0.40mA/°C | | 0.33mA/°C | 0.40mA/°C/0.33mA/°C |
| Ambient Temperature Range | | -25°C ~ +55°C | | | |

PC TERMINALS

P Straight

H Right Angle with Bracket

V Vertical with Bracket

TYPICAL SWITCH DIMENSIONS

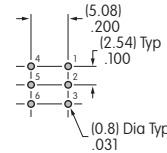
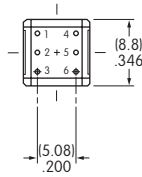
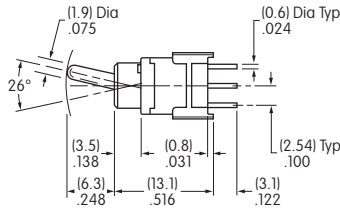
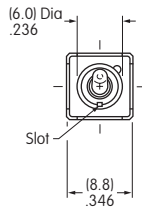

Straight PC



B12JPC

Terminal 4 is a support pin on single color models.

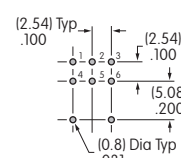
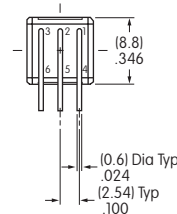
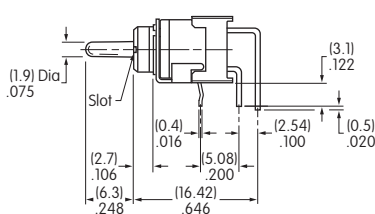
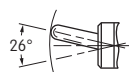
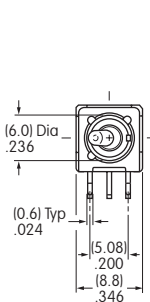

Right Angle PC



B13JJHCF

Terminal 4 is a support pin on single color models.

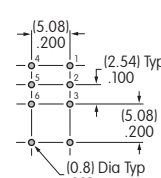
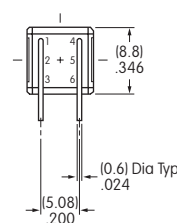
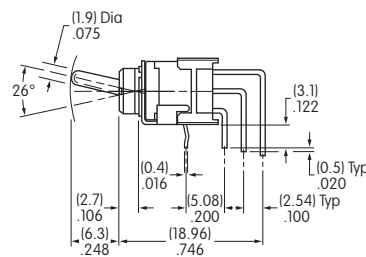
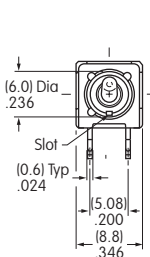

Vertical PC



B13JJVCF

Terminal 4 is a support pin on single color models.