

PRODUCT DATASHEET

ANGELINA series

last update 3/11/2016

DETAILS

Product Number	FCN13695_ANGELINA-M
Family	ANGELINA
Type	RefPack
Color	metal
Diameter	82 mm
Height	36,04 mm
Style	round
Optic Material	
Holder Material	
Fastening	screw
Status	production ready
ROHS Compliant	Yes
Date Updated	3/11/2016

OPTICAL PROPERTIES

LED	Viewing Angle	Light Beam	Efficiency	cd/lm	Connector
VERO13	31 deg	Medium	92 %	1.700	LEDiL: LEDiL
VERO18	38 deg	Medium	92 %	1.400	LEDiL: LEDiL
V15 Gen6	37 deg	Medium	92 %	1.400	Bender Wirth: 456 Typ L2
V10 Gen7	sim: 31	Medium	sim: 93 %	sim: 1.820	Bender Wirth: 434 Typ L1
CLL03x/CLU03x	37 deg	Medium	91 %	1.300	Bender Wirth: 433 Typ L1
CLU700/701	26 deg	Medium	92 %	1.600	Bender Wirth: 434 Typ L1
CLL02x/CLU02x (LES10)	31 deg	Medium	92 %	1.400	Bender Wirth: 434 Typ L1
CLU720/721	33 deg	Medium	91 %	1.400	-
CXA/B 1816 & CXA/B 1820 & CXA 1850	36 deg	Medium	91 %	1.300	Bender Wirth: 437 Typ L1
CXA/B 15xx	28 deg	Medium	92 %	1.500	Bender Wirth: 441 Typ L1
LUXEON CoB 1202/1203	32 deg	Medium	92 %	1.400	Bender Wirth: 438 Typ L1
CXM-14	sim: 37	Medium	sim: 91 %	sim: 1.300	Bender Wirth: 433 Typ L1
CXM-9	sim: 31	Medium	sim: 92 %	sim: 1.400	Bender Wirth: 434 Typ L1
COB J-Type	38 deg	Medium	92 %	1.200	Bender Wirth: 463 Typ L2
COB L-Type (LES 11)	32 deg	Medium	92 %	1.400	Bender Wirth: 438 Typ L1
Soleroq P9	31 deg	Medium	92 %	1.500	Bender Wirth: 461 Typ L1
Soleroq P13	35 deg	Medium	94 %	1.300	Bender Wirth: 437 Typ L1
Soleroq S13	34 deg	Medium	92 %	1.300	Bender Wirth: 437 Typ L1
LC026B/LC040B	41 deg	Medium	92 %	1.100	Bender Wirth: 450 Typ L2
ZC12/18	sim: 37	Medium	sim: 92 %	sim: 2.300	Bender Wirth: 433 Typ L1
ZC4/6	sim: 31	Medium	sim: 92 %	sim: 1.400	Bender Wirth: 434 Typ L1
SLE G5 LES11	30 deg	Medium	92 %	1.500	Bender Wirth: 434 Typ L1

Relative intensity of FCN13695_ANGELINA-M_(V15)

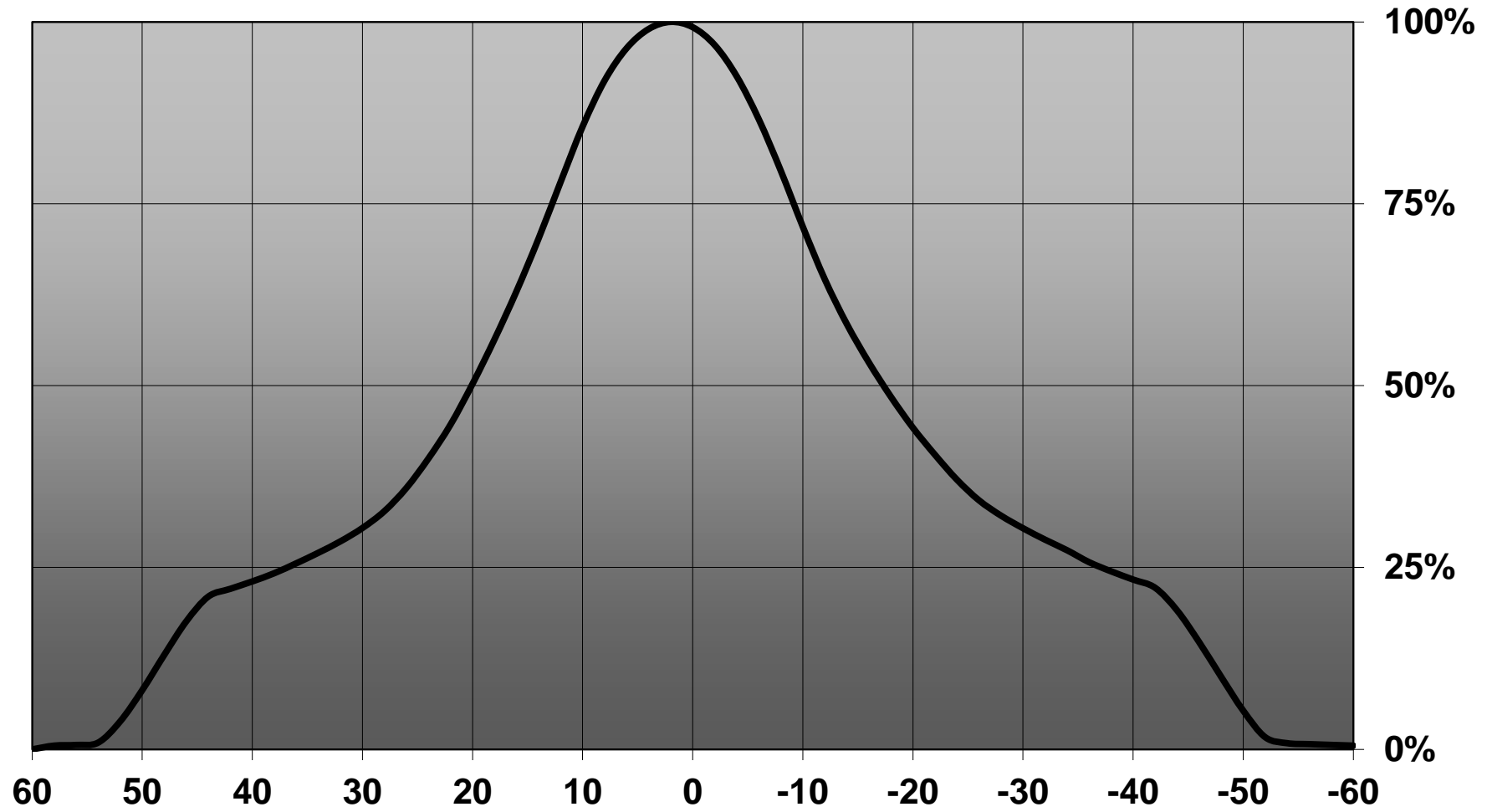

H G F E D C B A

4

3

2

1

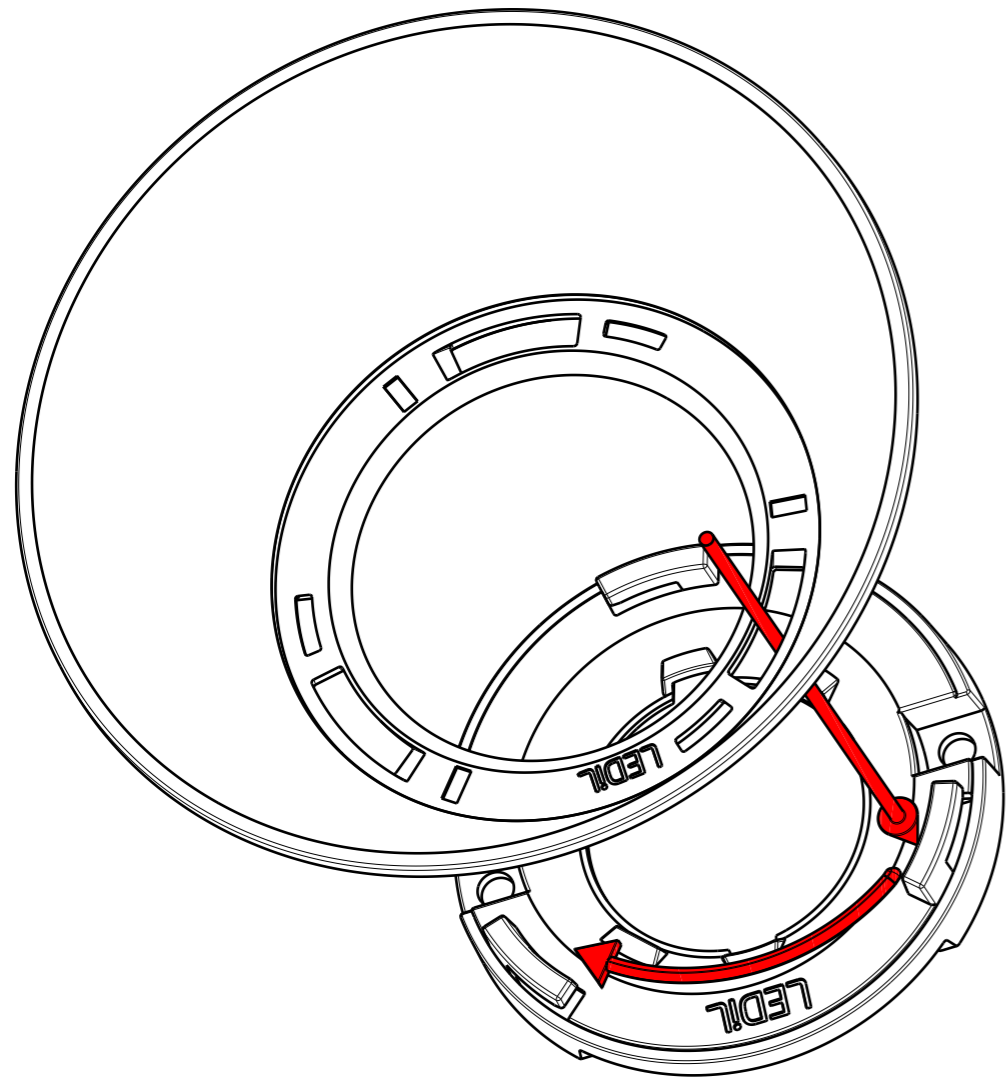

31 + Basepart

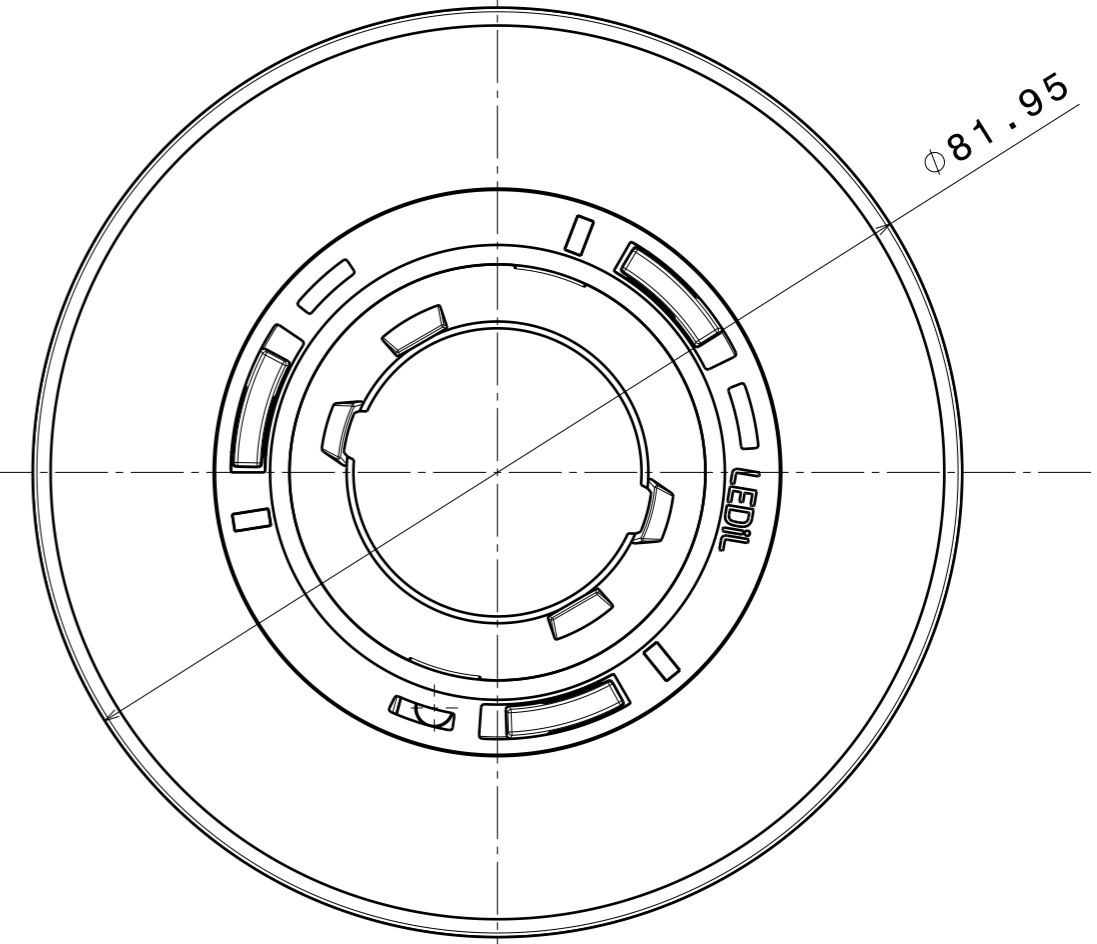
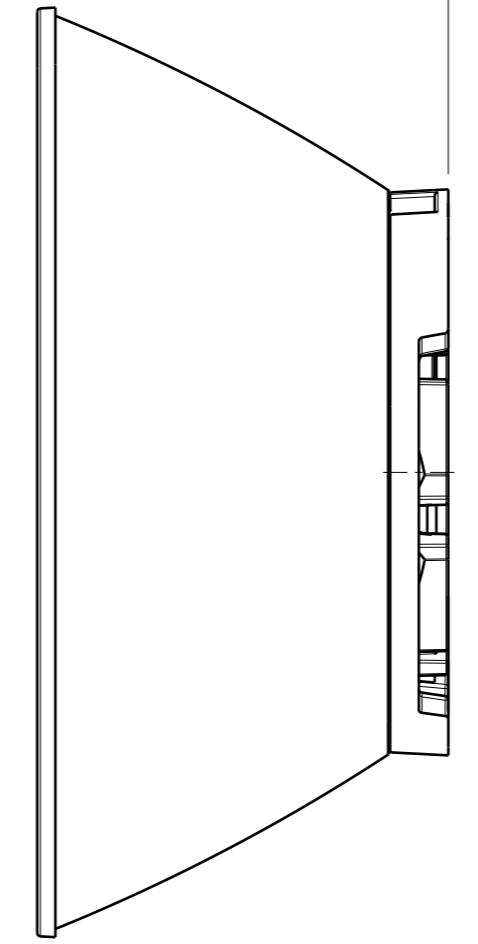

Tolerances if not otherwise shown
 According to DIN ISO 2768-1
 Linear measures:
 Up to 30mm class M, otherwise class C.
 According to DIN ISO 2768-2
 Form and position: class L

LEDiL Ledil Oy
 Salorankatu 10
 FIN 24240 SALO
 Finland

THIRD ANGLE PROJECTION:

DRAWING TITLE
Datasheet_ANGELINA + CLAMP

This drawing is the property of LEDiL Oy. It may not be reproduced, copied or communicated without a written agreement with LEDiL Oy.

SIZE	PART NUMBER		
A3	-		

SCALE	3:2	WEIGHT (g)		SHEET	1/1
-------	-----	------------	--	-------	-----

H G F E D C B A

Luminaire: LEDiL Oy FCN13695_ANGELINA-M_(VERO13) Eff.92.5%
Lamps: 1 x VERO13_(BXRC-30E2000C) 922.394lm@250mA CCT=3000K P=8 I=250mA

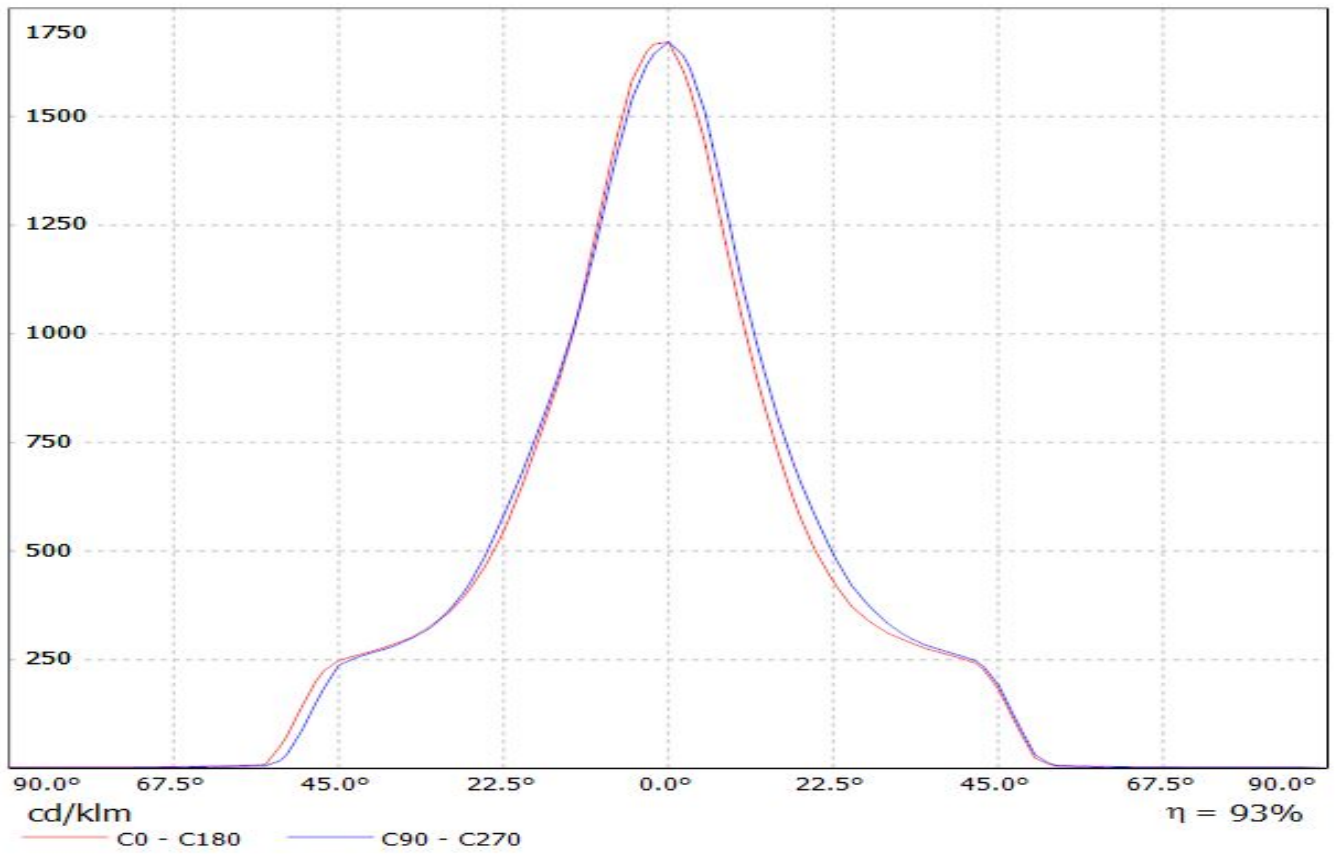

Luminaire: LEDiL Oy FCN13695_ANGELINA-M_(VERO18) Eff.91.7%
Lamps: 1 x VERO18_(BXRC-30E4000F) 906.273lm@250mA CCT=3000K P=7 I=250mA

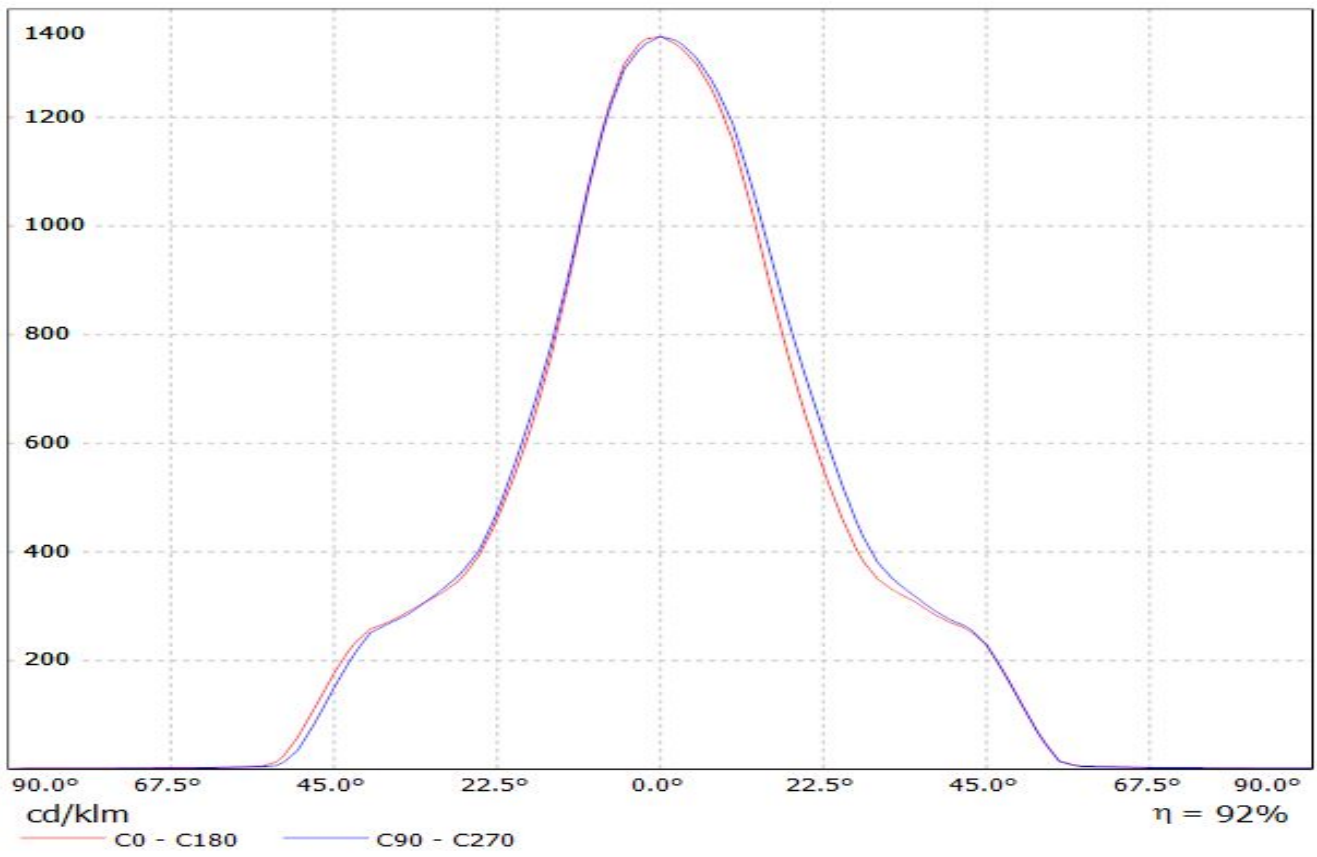

Luminaire: Ledil Oy FCN13695_ANGELINA-M+_B+W_434_TypL1_BRIDGELUX_V10_Gen7_SIMULATED
Lamps: 1 x BRIDGELUX V10 Gen7

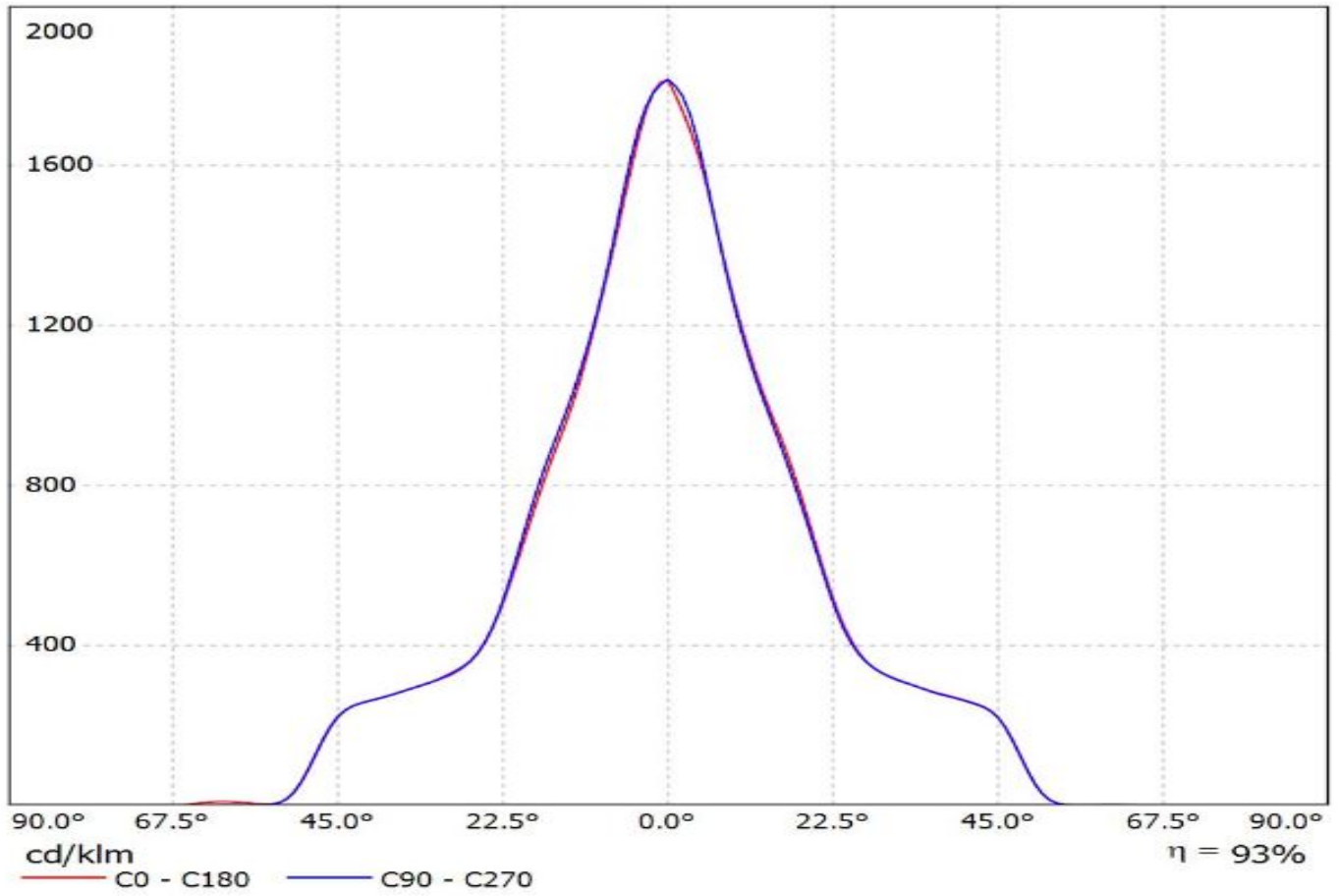

Luminaire: Ledil FCN13695_ANGELINA-M_(CLU034)_ (433_Typ_L1)_ (C13658) Citizen_CLU034_(CLU034-1205B8-303M1A2)_ 1180.79lm@250mA_P=8.50075W_I=0.25A
Lamps: 1 x Citizen_CLU034_(433_Typ_L1)_ (C13658)_ 1173.16lm@250mA_P=8.475W_I=0.25A

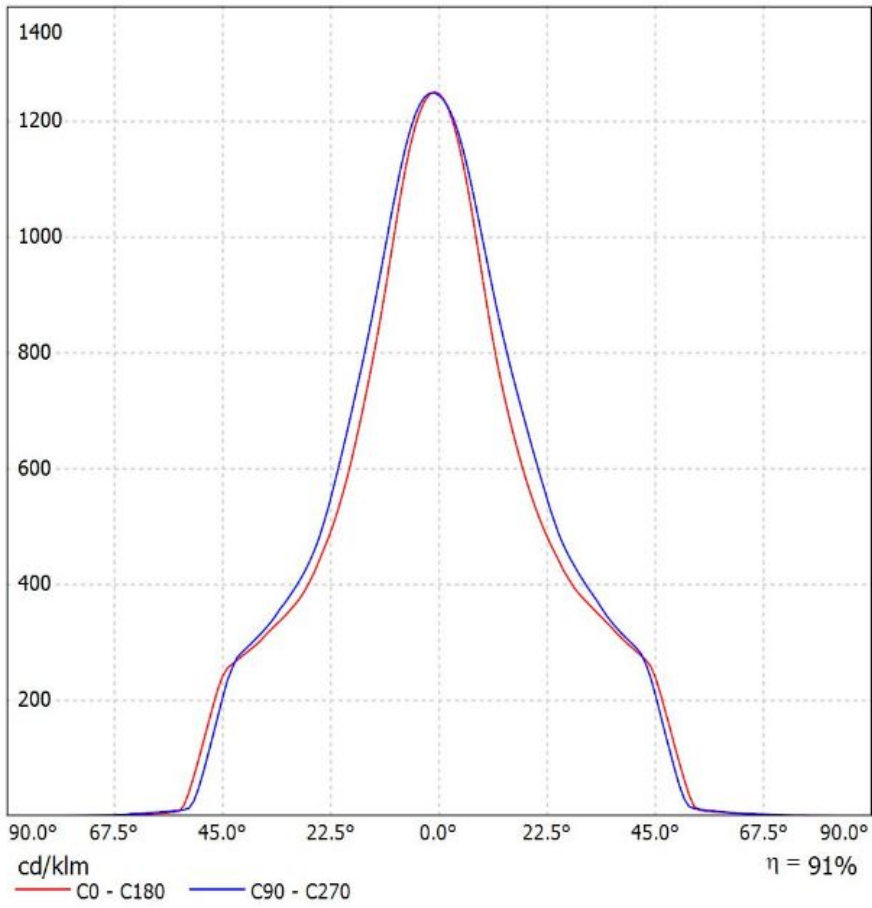

Luminaire: Ledil FCN13695_ANGELINA-M_(CLU700)_ (434_Typ_L1) Citizen_CLU700_(CLU700-1002B8-273M2G1)_390.128lm@100mA_P=3W_I=0.10A
Lamps: 1 x Citizen_CLU700_(CLU700-1002B8-273M2G1)_388.036lm@100mA_P=3W_I=0.10A

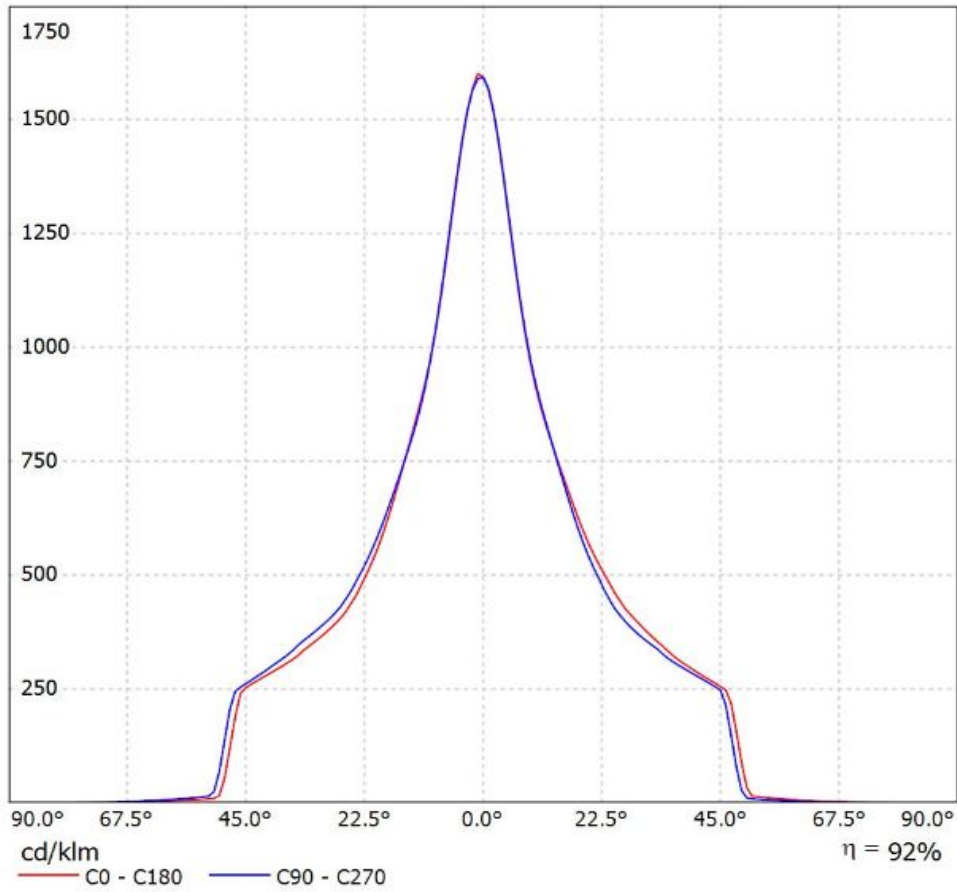

Luminaire: Ledil FCN13695_ANGELINA-M_(CLU024)_(433_Typ_L1) Citizen_CLU024_(433_Typ_L1)_
(C13658_CLAMP-VERO13-18)_1071.07lm@250mA_P=8.43W_I=0.25A
Lamps: 1 x Citizen_CLU024_(433_Typ_L1)_(C13658_CLAMP-VERO13-18)
_1071.07lm@250mA_P=8.43W_I=0.25A

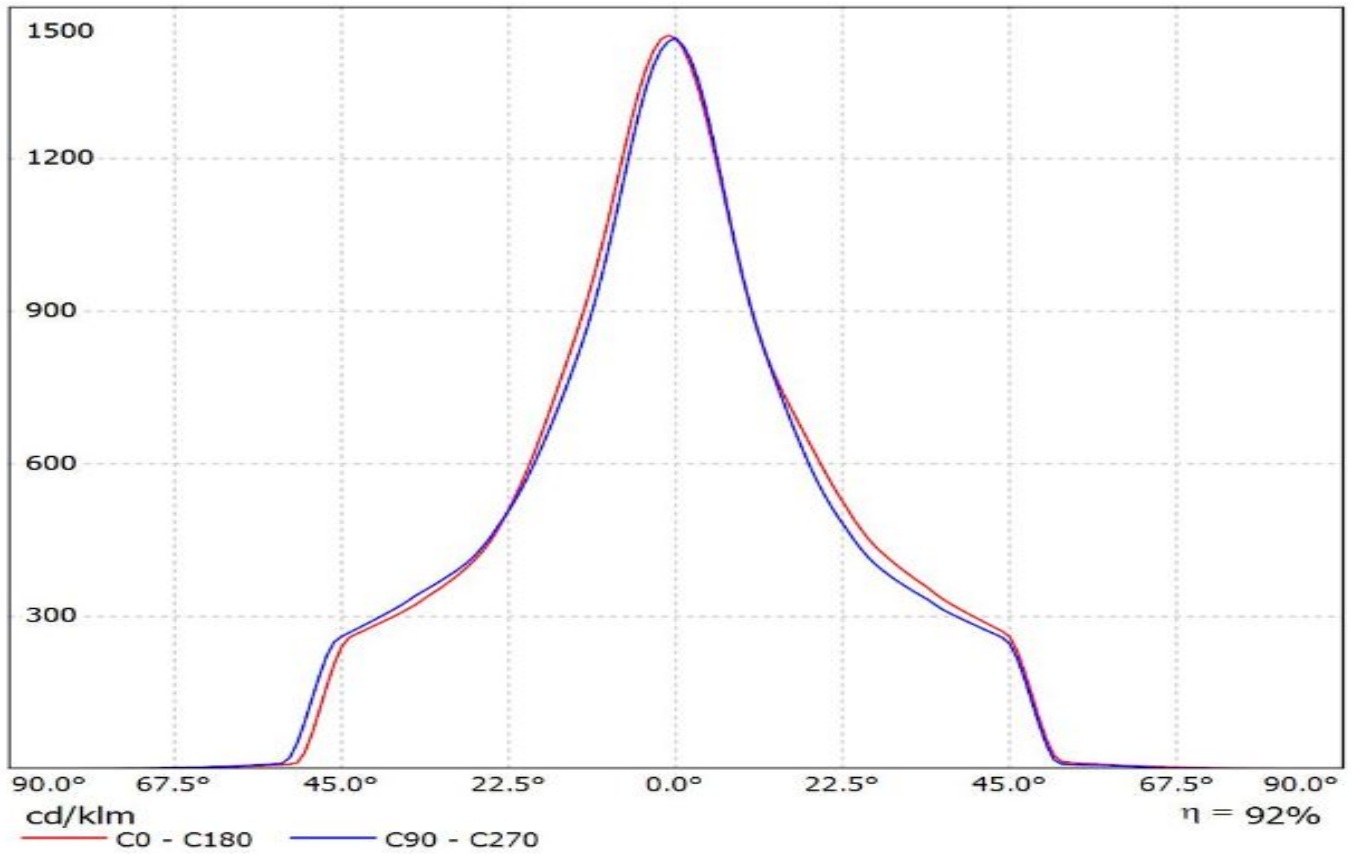

Luminaire: Ledil FCN13695_ANGELINA-M_(CLU720)_(433_Typ_L1)

Lamps: 1 x Citizen_CLU720_(CLU720-1206B8-273M2G1)_1225.89lm@250mA_P=8.3W_I=0.25A

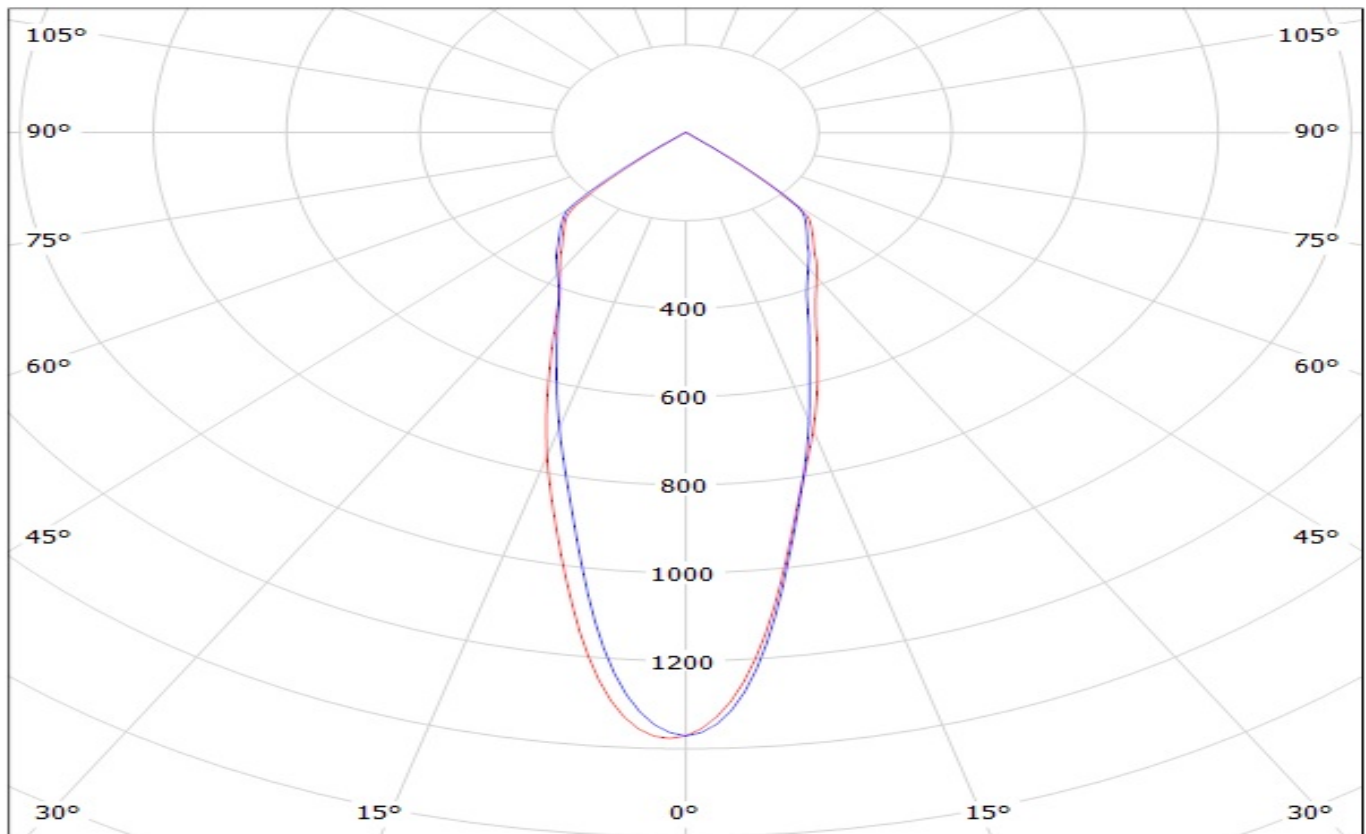

cd/klm

— C0 - C180

— C90 - C270

$\eta = 91\%$

Luminaire: Ledil FCN13695_ANGELINA-M_(CXA1850)

Lamps: 1 x CREE_CXA1850_(CXA1850-30F-T4-N0Y-00001)_831.914lm@250mA_CCT=3000K_P=8.27W_I=0.25A

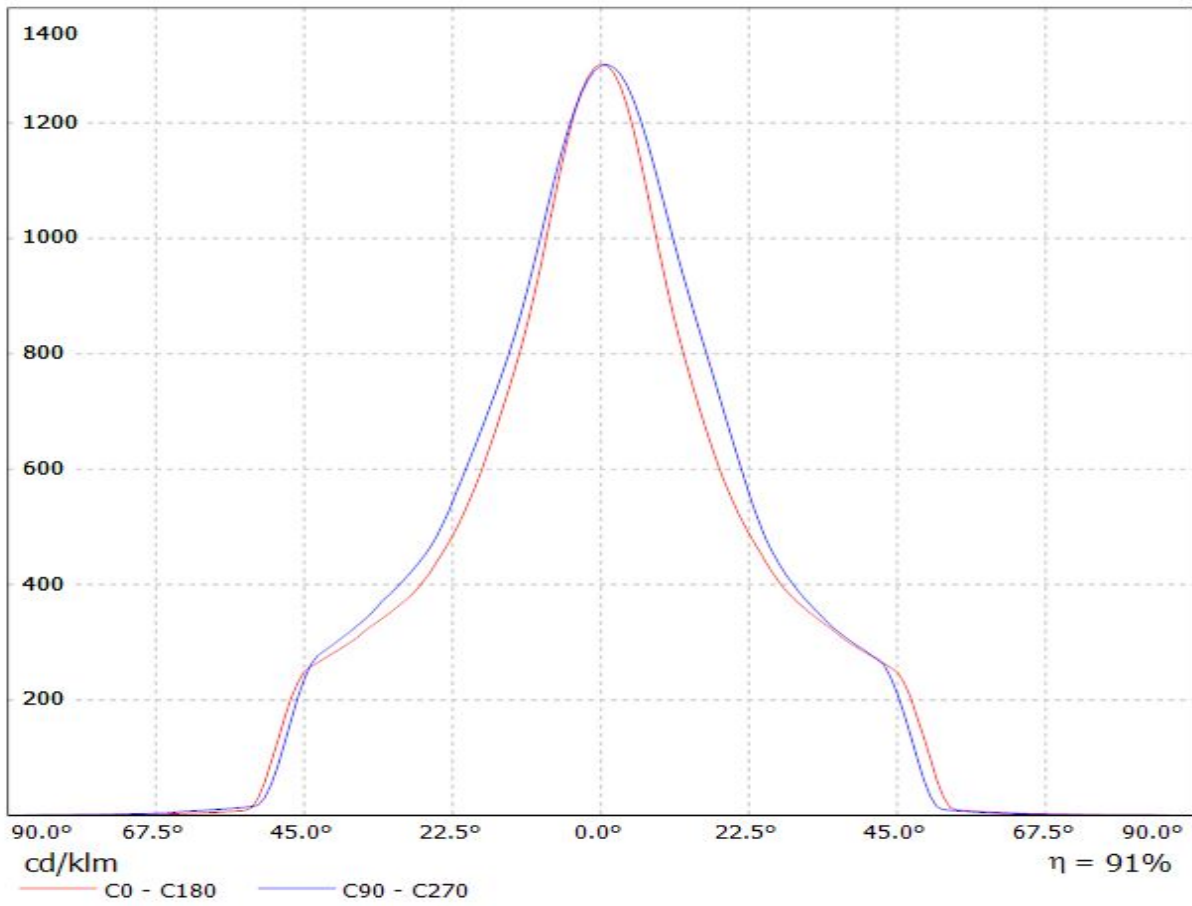

Luminaire: LEDiL Oy FCN13695_ANGELINA-M_(CXA1520)_ (441_Typ_L1)

Lamps: 1 x Cree_CXA1520_(CXA1520-30F-N4-N0H-00001)_993.209lm@250mA_P=8.74575W_I=0.2499A

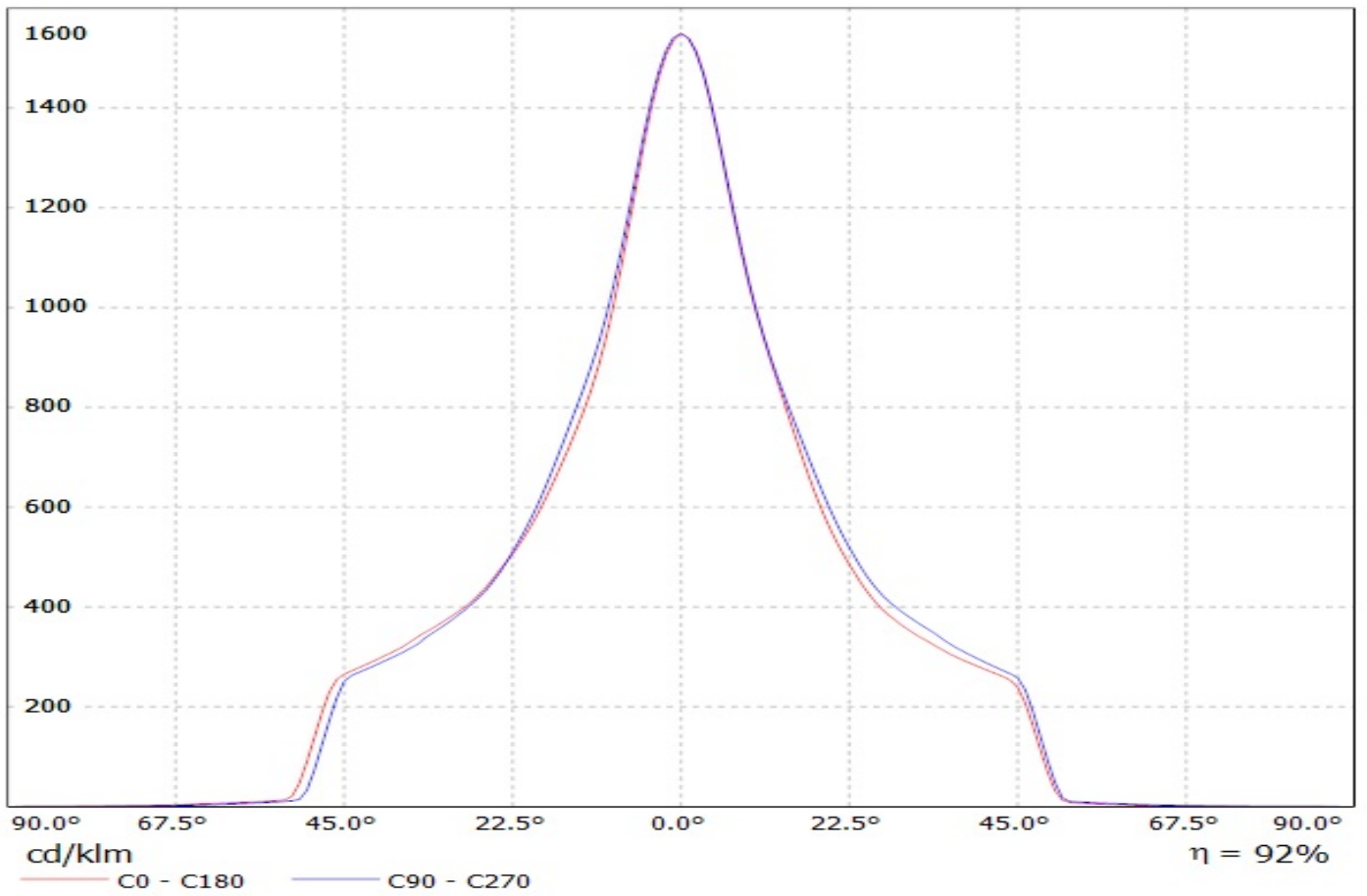

Luminaire: LEDiL Oy FCN13695_ANGELINA-M_(LUXEON_CoB_1203)_ (438_Typ_L1)_ (C13658_CLAMP-VERO13-18)
Lamps: 1 x LUXEON_CoB_1203_(438_Typ_L1)_ (C13658_CLAMP-VERO13-18)_984.561lm@250mA_P=8.6828W_I=0.25A

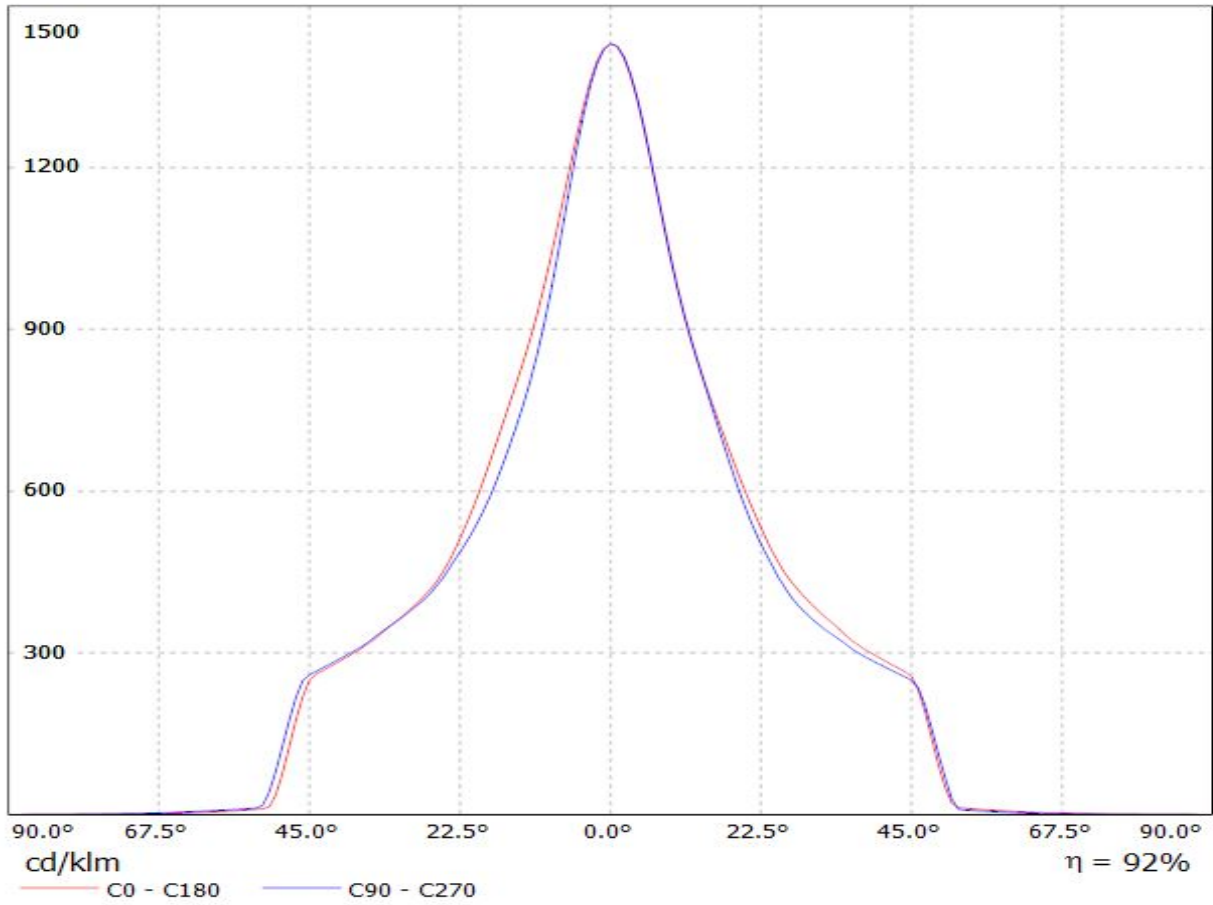

Luminaire: LEDiL Oy FCN13695_ANGELINA-M_(NFDxJ130B)

Lamps: 1 x Nichia_NFDxJ130B_(463 Typ L2)_C13658_CLAMP-VERO13-18_1458.51lm@250mA_P=8.87739W_I=0.2498A

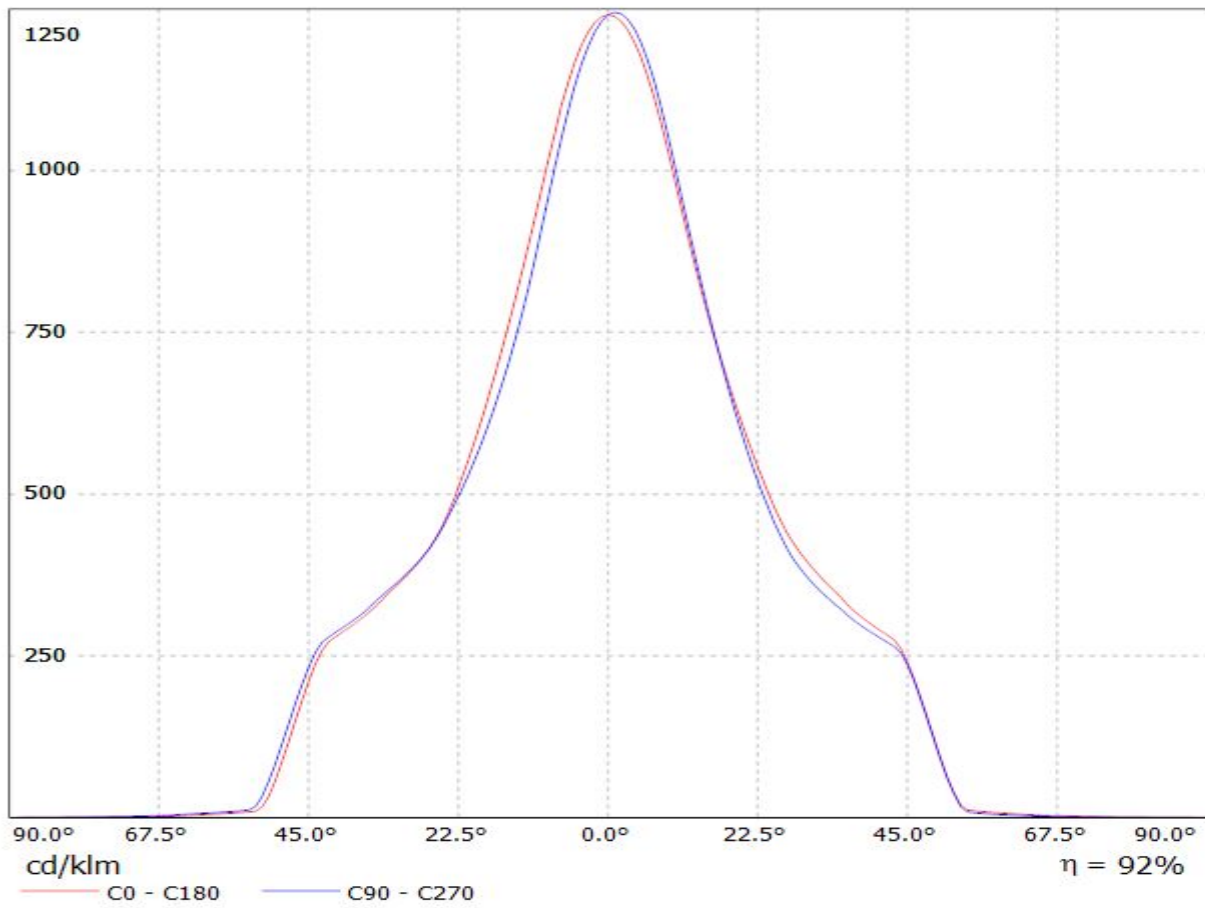

Luminaire: LEDiL Oy FCN13695_ANGELINA-M_(NFCxL060B)_(438_Typ_L1)

Lamps: 1 x Nichia_NFCxL060B_(SM403G2450R8000)_(C13658)_(438_Typ_L1)_1298.52@250mA_P=8.45498W_I=0.2498A

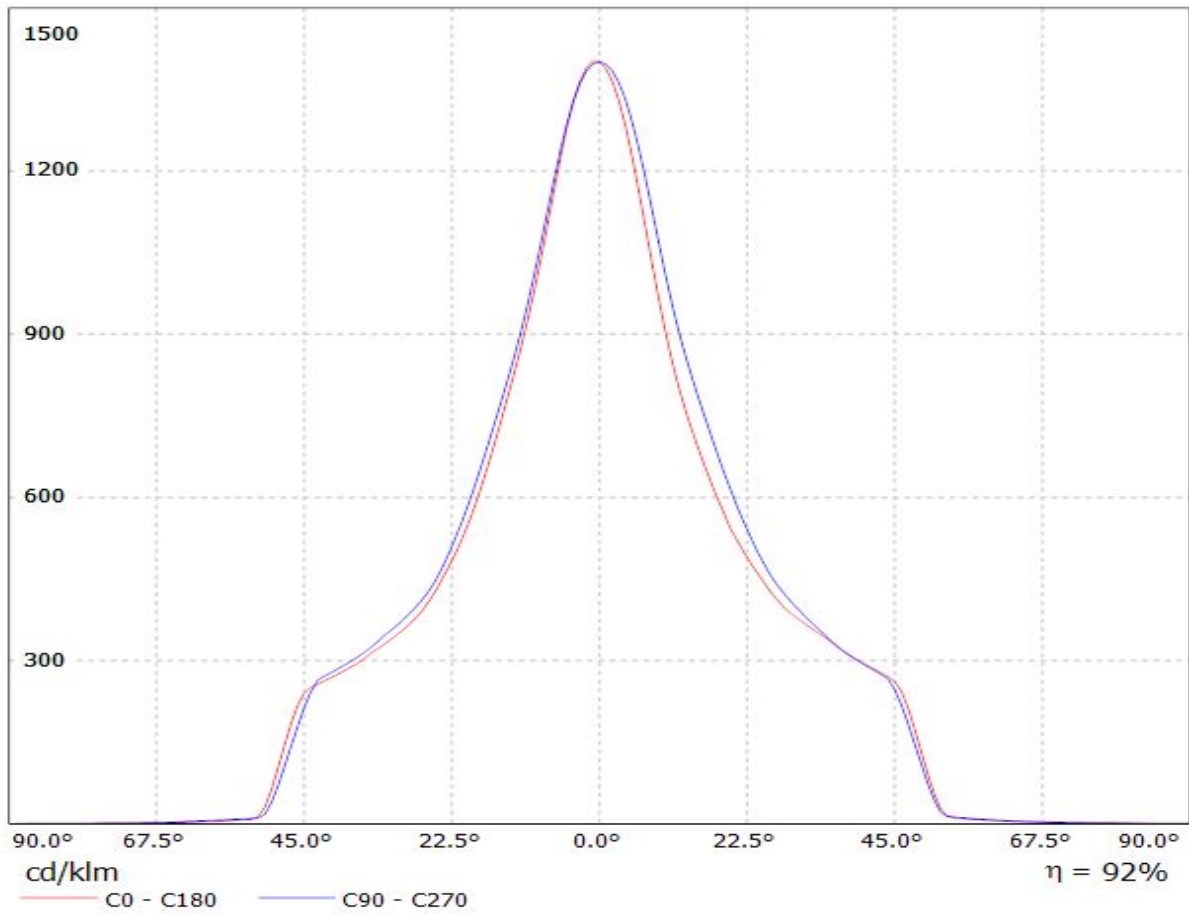

Luminaire: Ledil FCN13695_ANGELINA-M (Soleriq_P9) + Bender+Wirth_461
Lamps: 1 x Osram_Soleriq_P9 (GW_MAFJB1.EM)_895.446lm@250mA_CCT=4299K_P=6.9W_I=0.25A

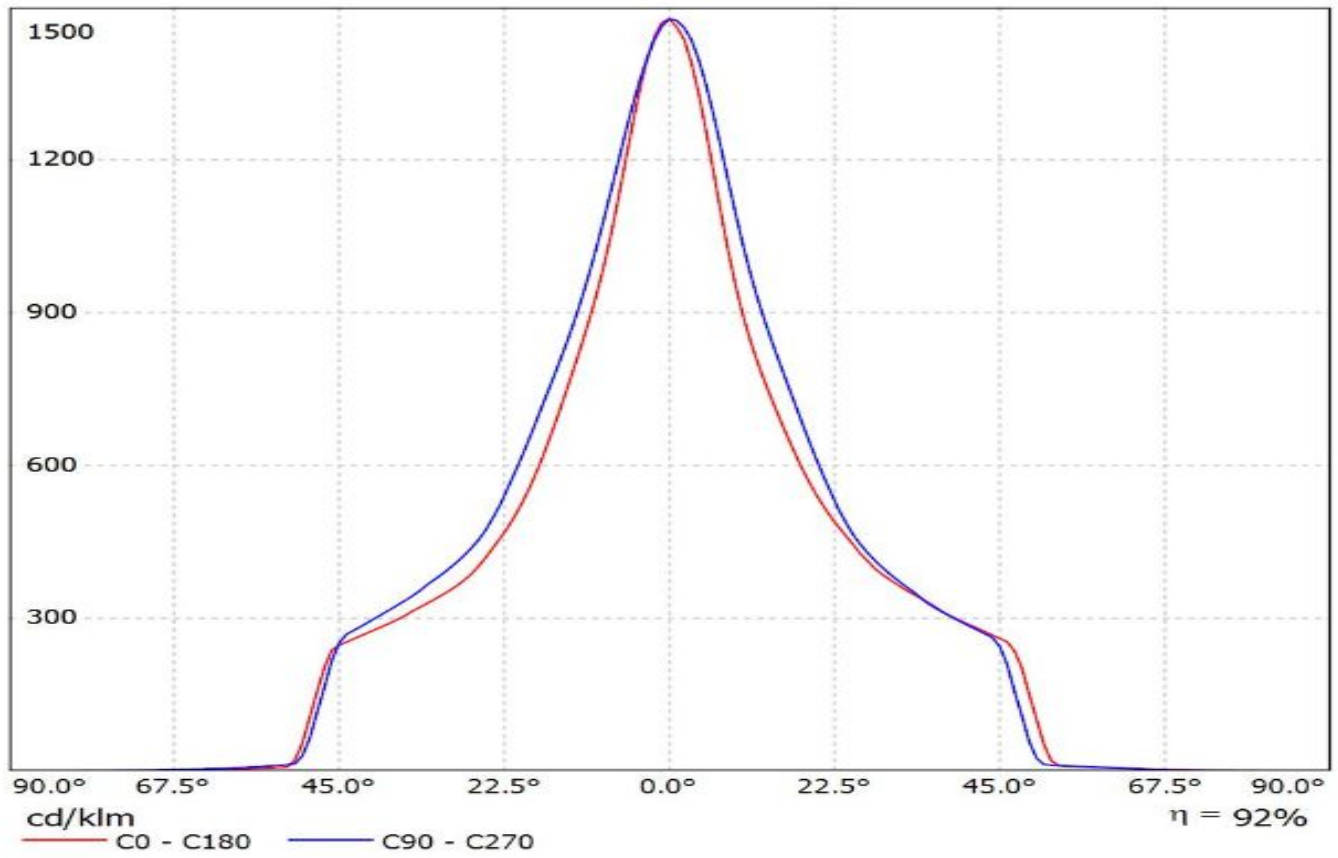

Luminaire: Ledil FCN13695_ANGELINA-M_(Soleriq_P13)

Lamps: 1 x Osman_Soleriq_P13_1009.11lm@250mA_P=6.9385W_I=0.25A

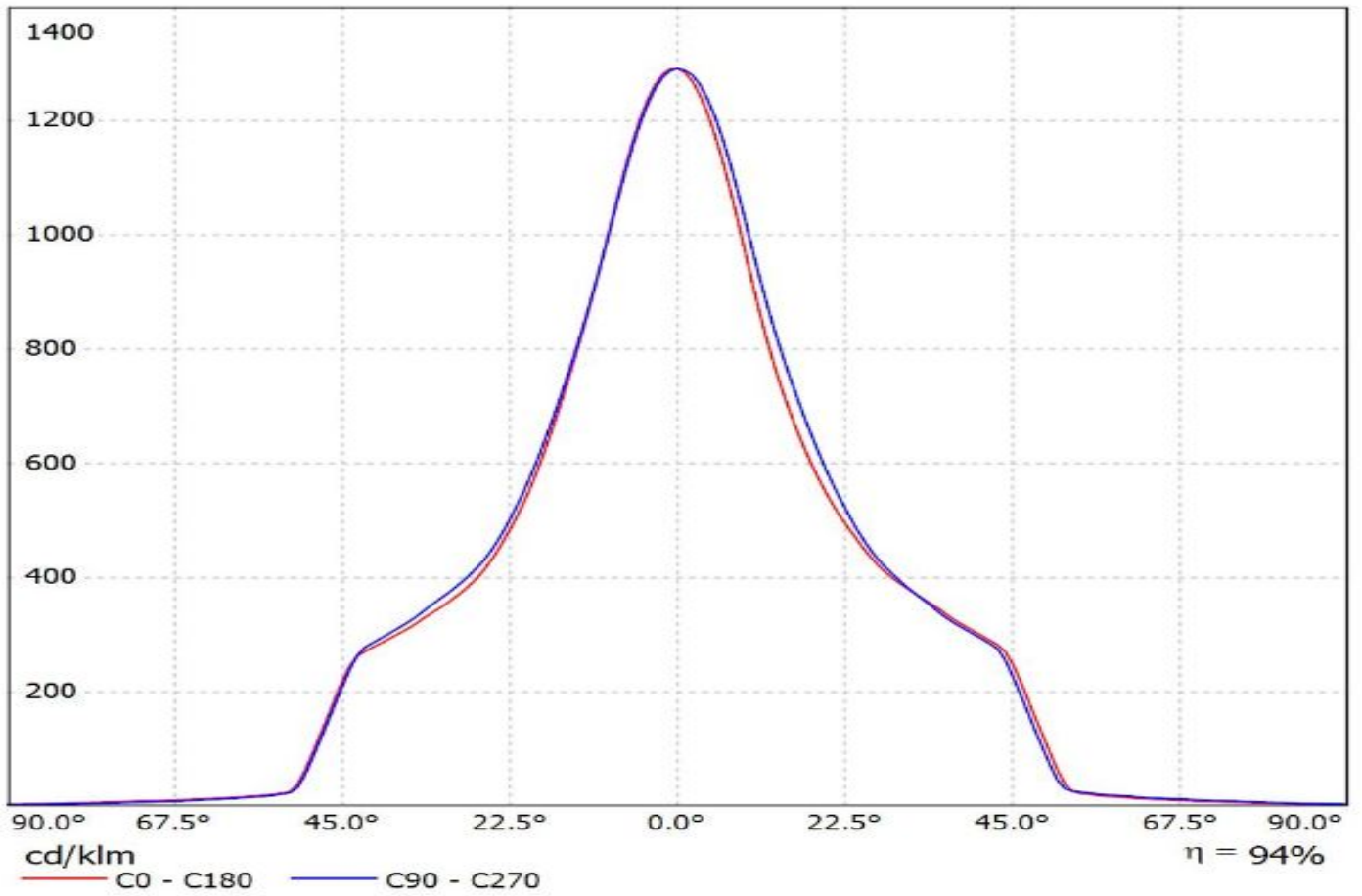

Ledil FCN13695_ANGELINA-M_(Soleriq_S13) / LDC (Linear)

Luminaire: Ledil FCN13695_ANGELINA-M_(Soleriq_S13)

Lamps: 1 x Osram_Soleriq_S13_(GW_KAGHB1.EM)_896.727lm@250mA_P=7.44679W_I=250mA

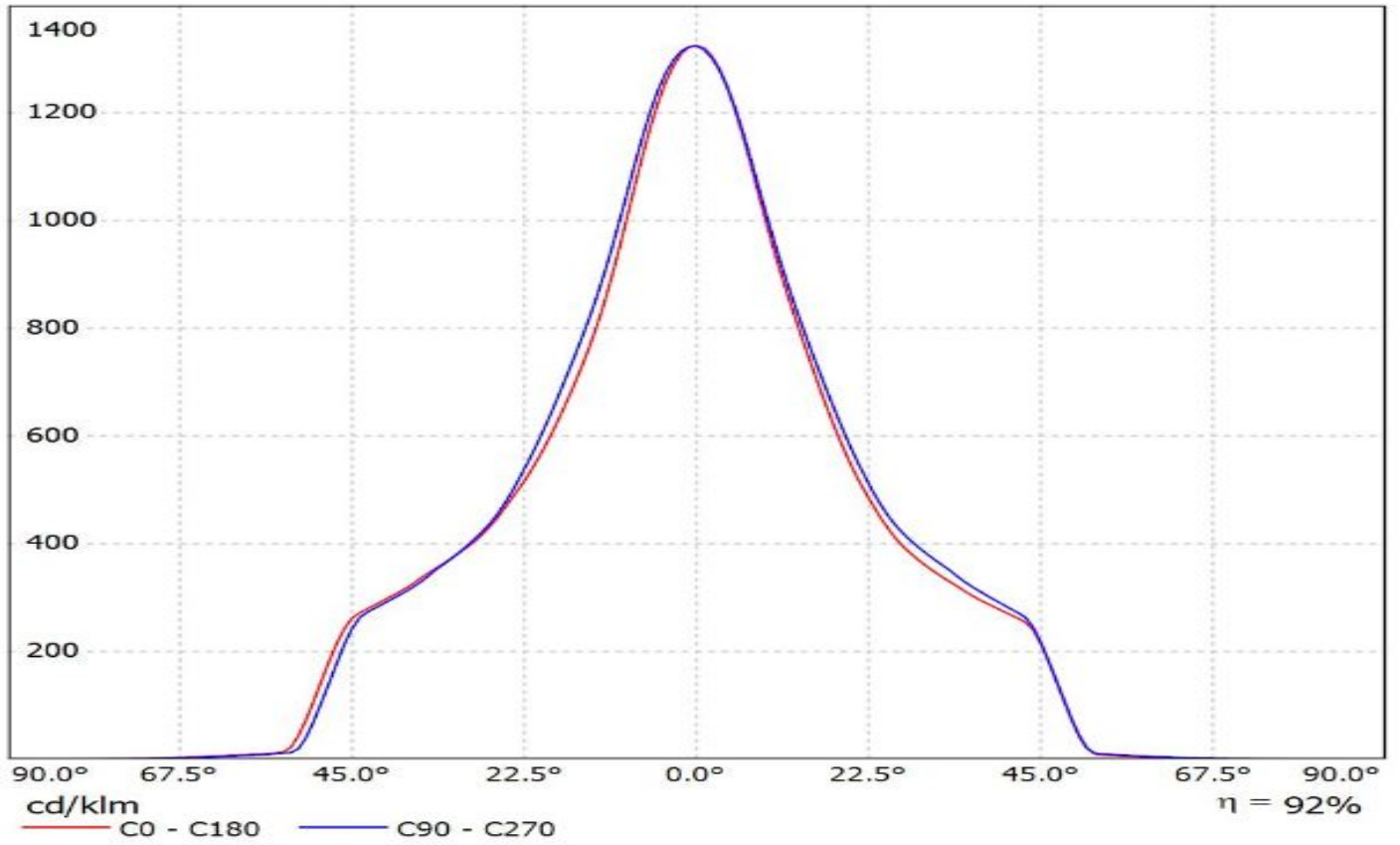

Luminaire: Ledil FCN13695_ANGELINA-M_(LC040B)_(450_Typ_L2)_(C13658_CLAMP-VERO13-18)
Lamps: 1 x Samsung_LC040B_CCT=3000K_(SPHWW1HDNE25010101)_(450_Typ_L2)_(C13658_CLAMP-VERO13-18)_1103.62lm@250mA_P=8.2W_I=0.25A

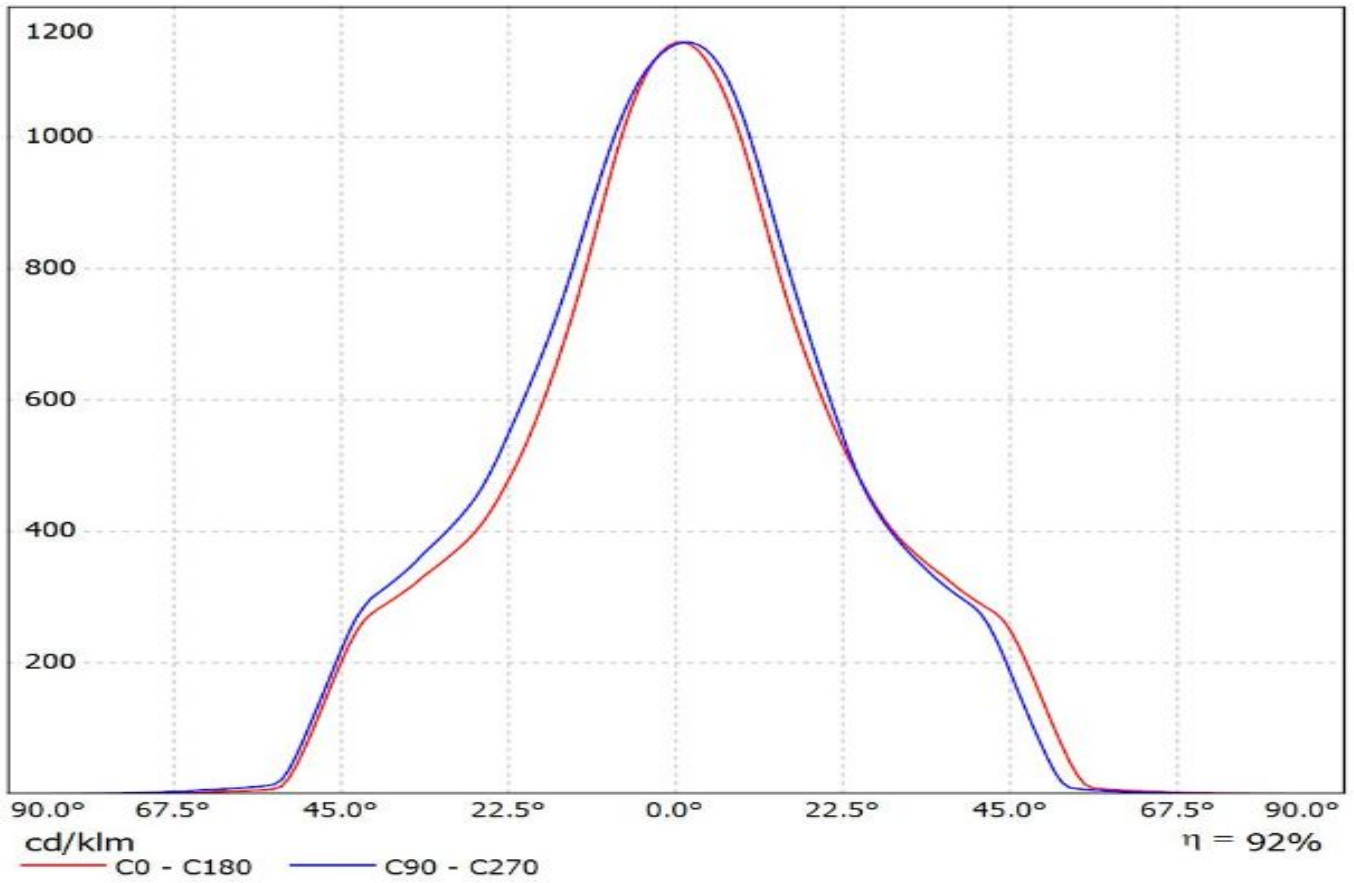

Luminaire: LEDiL Oy FCN13695_ANGELINA-M_(SLE-G5_LES-11)

Lamps: 1 x Tridonic_SLE-G5_LES-11_1137.55lm@250mA_P=8.4177W_I=0.250A

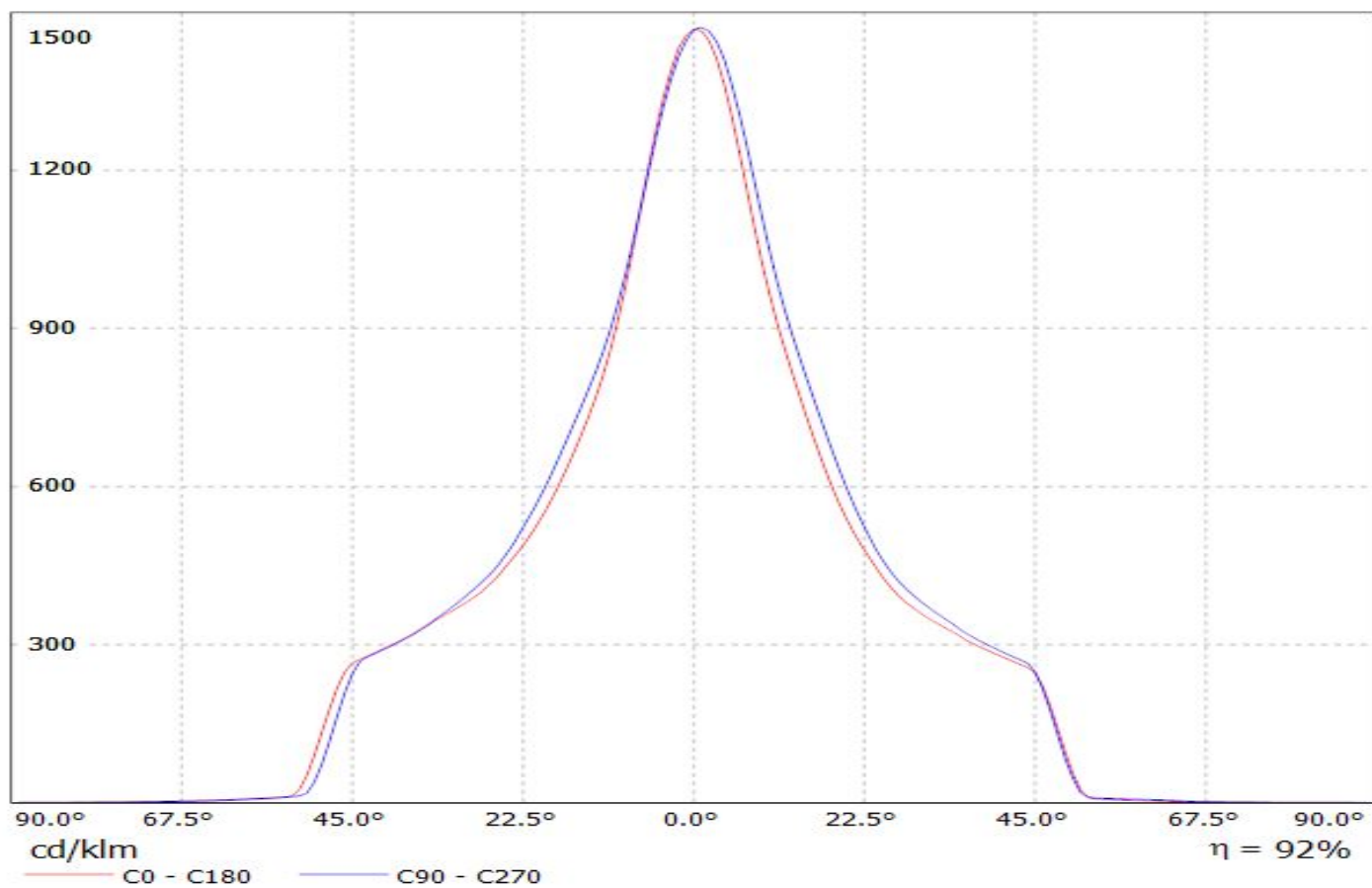

Luminaire: LEDiL Oy FCN13695_ANGELINA-M_(VERO13) Eff.92.5%
Lamps: 1 x VERO13_(BXRC-30E2000C) 922.394lm@250mA CCT=3000K P=8 I=250mA

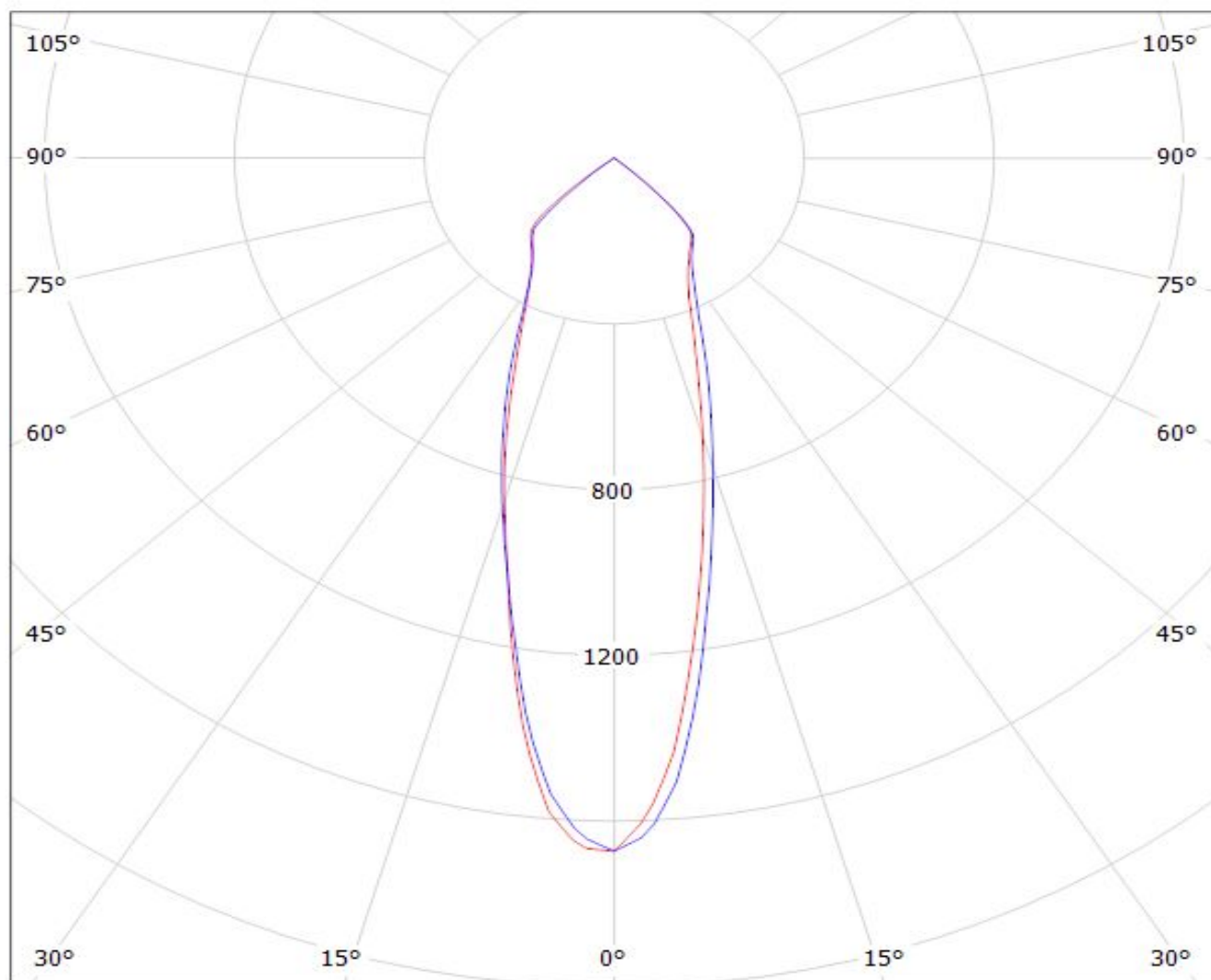

cd/klm

— C0 - C180

— C90 - C270

$\eta = 93\%$

Luminaire: LEDiL Oy FCN13695_ANGELINA-M_(VERO18) Eff.91.7%

Lamps: 1 x VERO18_(BXRC-30E4000F) 906.273lm@250mA CCT=3000K P=7 I=250mA

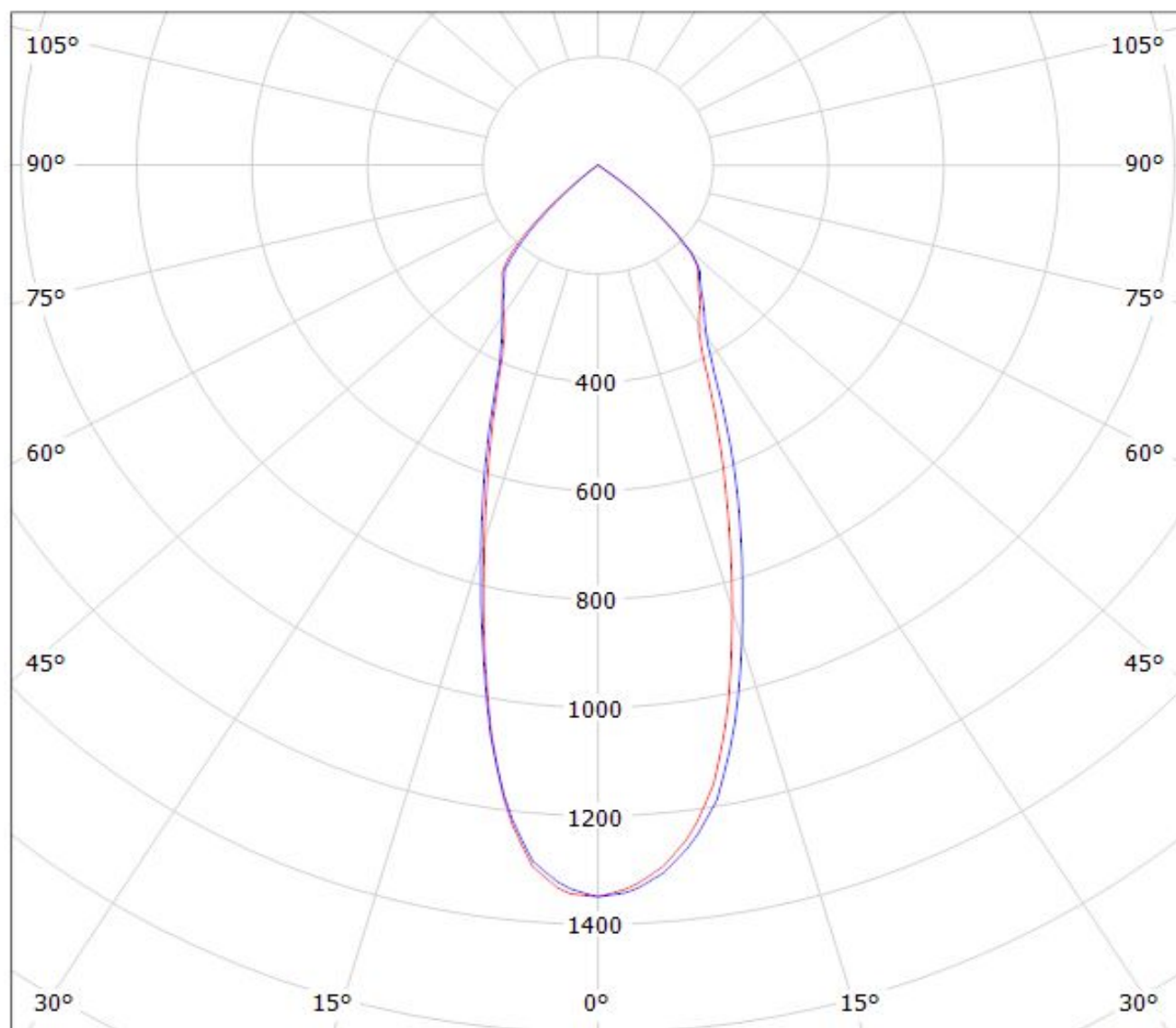

cd/klm

— C0 - C180

— C90 - C270

$\eta = 92\%$

Luminaire: Ledil Oy FCN13695_ANGELINA-M+_B+W_434_TypL1_BRIDGELUX_V10_Gen7_SIMULATED
Lamps: 1 x BRIDGELUX V10 Gen7

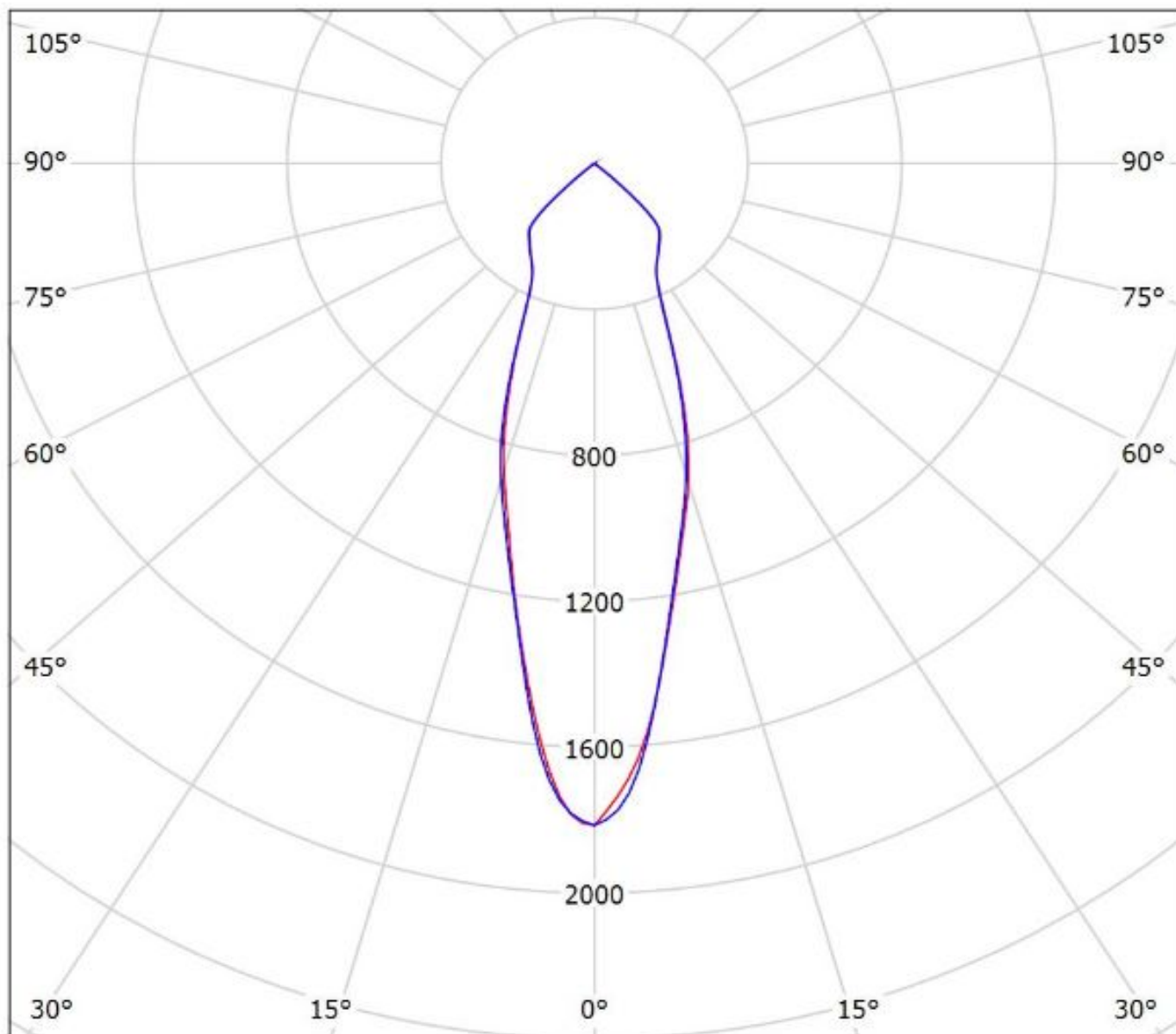

cd/klm

— C0 - C180 — C90 - C270

$\eta = 93\%$

Luminaire: Ledil FCN13695_ANGELINA-M_(CLU034)_ (433_Typ_L1)_ (C13658) Citizen_CLU034_(CLU034-1205B8-303M1A2)_1180.79lm@250mA_P=8.50075W_I=0.25A
Lamps: 1 x Citizen_CLU034_(433_Typ_L1)_ (C13658)_1173.16lm@250mA_P=8.475W_I=0.25A

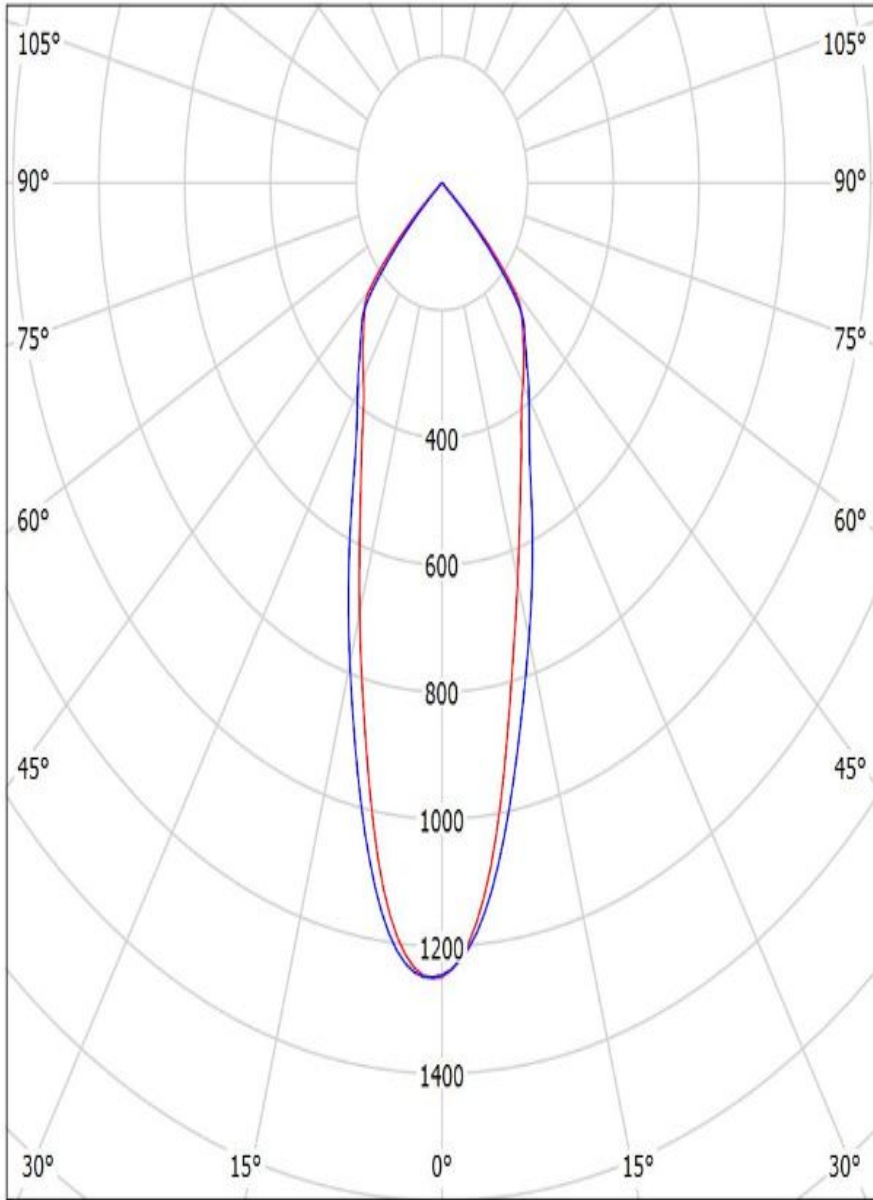

cd/klm

— C0 - C180 — C90 - C270

$\eta = 91\%$

Luminaire: Ledil FCN13695_ANGELINA-M_(CLU700)_434_Typ_L1 Citizen_CLU700_(CLU700-1002B8-273M2G1)_390.128lm@100mA_P=3W_I=0.10A
Lamps: 1 x Citizen_CLU700_(CLU700-1002B8-273M2G1)_388.036lm@100mA_P=3W_I=0.10A

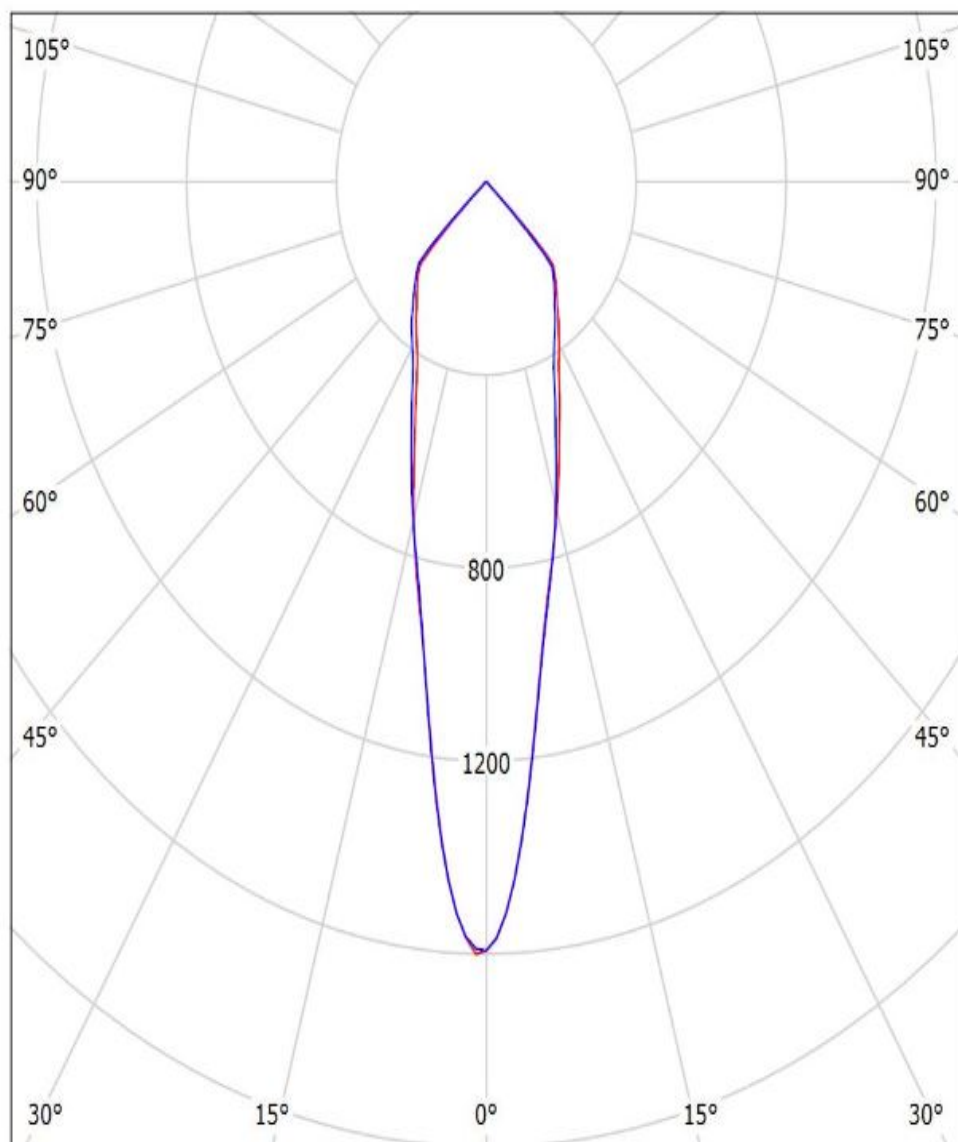

cd/klm

— C0 - C180 — C90 - C270

$\eta = 92\%$

Luminaire: Ledil FCN13695_ANGELINA-M_(CLU024)_ (433_Typ_L1) Citizen_CLU024_(433_Typ_L1)_
(C13658_CLAMP-VERO13-18)_1071.07lm@250mA_P=8.43W_I=0.25A
Lamps: 1 x Citizen_CLU024_(433_Typ_L1)_ (C13658_CLAMP-VERO13-18)
_1071.07lm@250mA_P=8.43W_I=0.25A

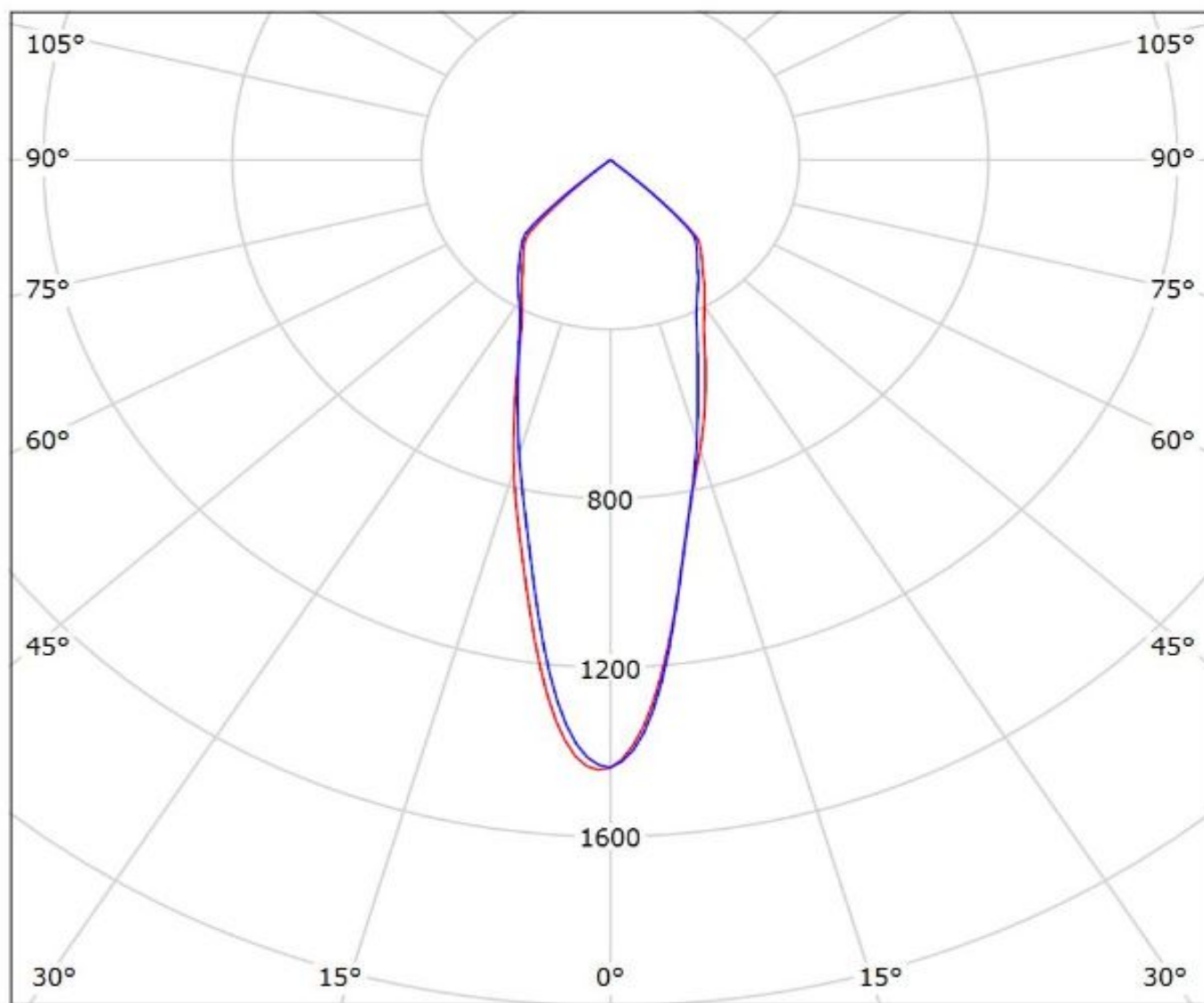

cd/klm
— C0 - C180 — C90 - C270

$\eta = 92\%$

Luminaire: Ledil FCN13695_ANGELINA-M_(CLU720)_ (433_Typ_L1)

Lamps: 1 x Citizen_CLU720_(CLU720-1206B8-273M2G1)_1225.89lm@250mA_P=8.3W_I=0.25A

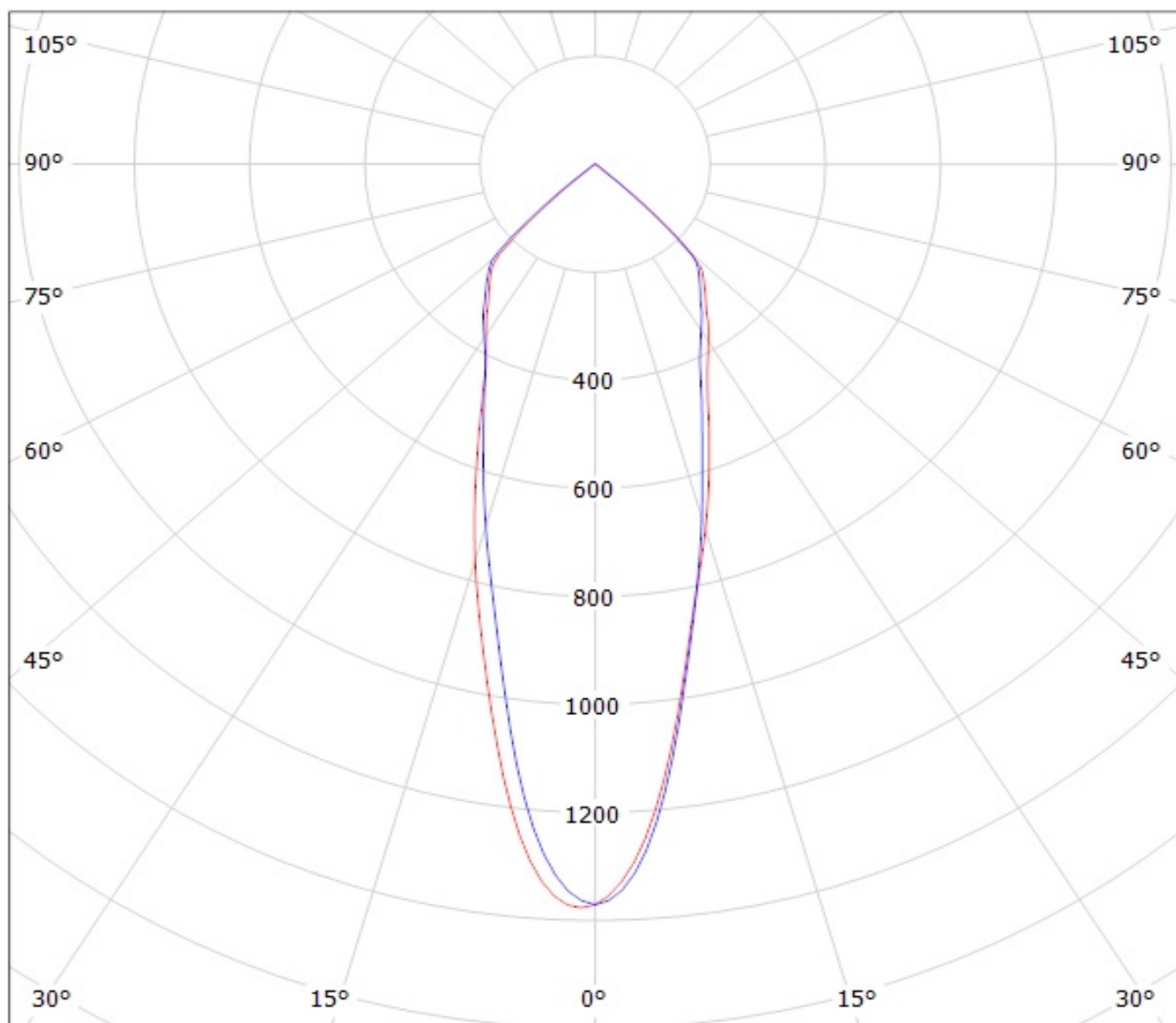

cd/klm

— C0 - C180 — C90 - C270

$\eta = 91\%$

Luminaire: Ledil FCN13695_ANGELINA-M_(CXA1850)

Lamps: 1 x CREE_CXA1850_(CXA1850-30F-T4-N0Y-00001)_831.914lm@250mA_CCT=3000K_P=8.27W_I=0.25A

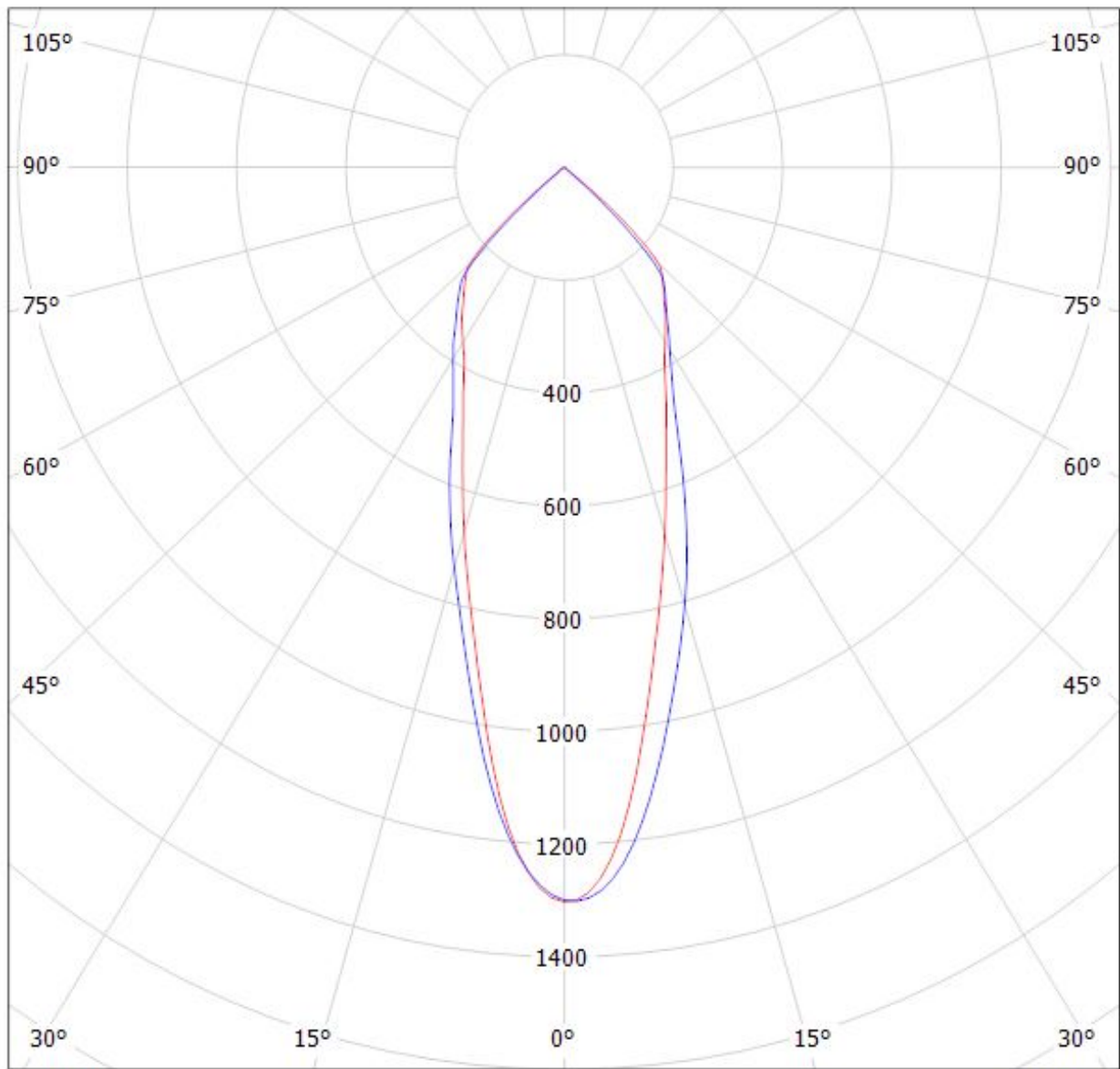

cd/klm

$\eta = 91\%$

— C0 - C180 — C90 - C270

Luminaire: LEDiL Oy FCN13695_ANGELINA-M_(CXA1520)_ (441_Typ_L1)

Lamps: 1 x Cree_CXA1520_(CXA1520-30F-N4-N0H-00001)_993.209lm@250mA_P=8.74575W_I=0.2499A

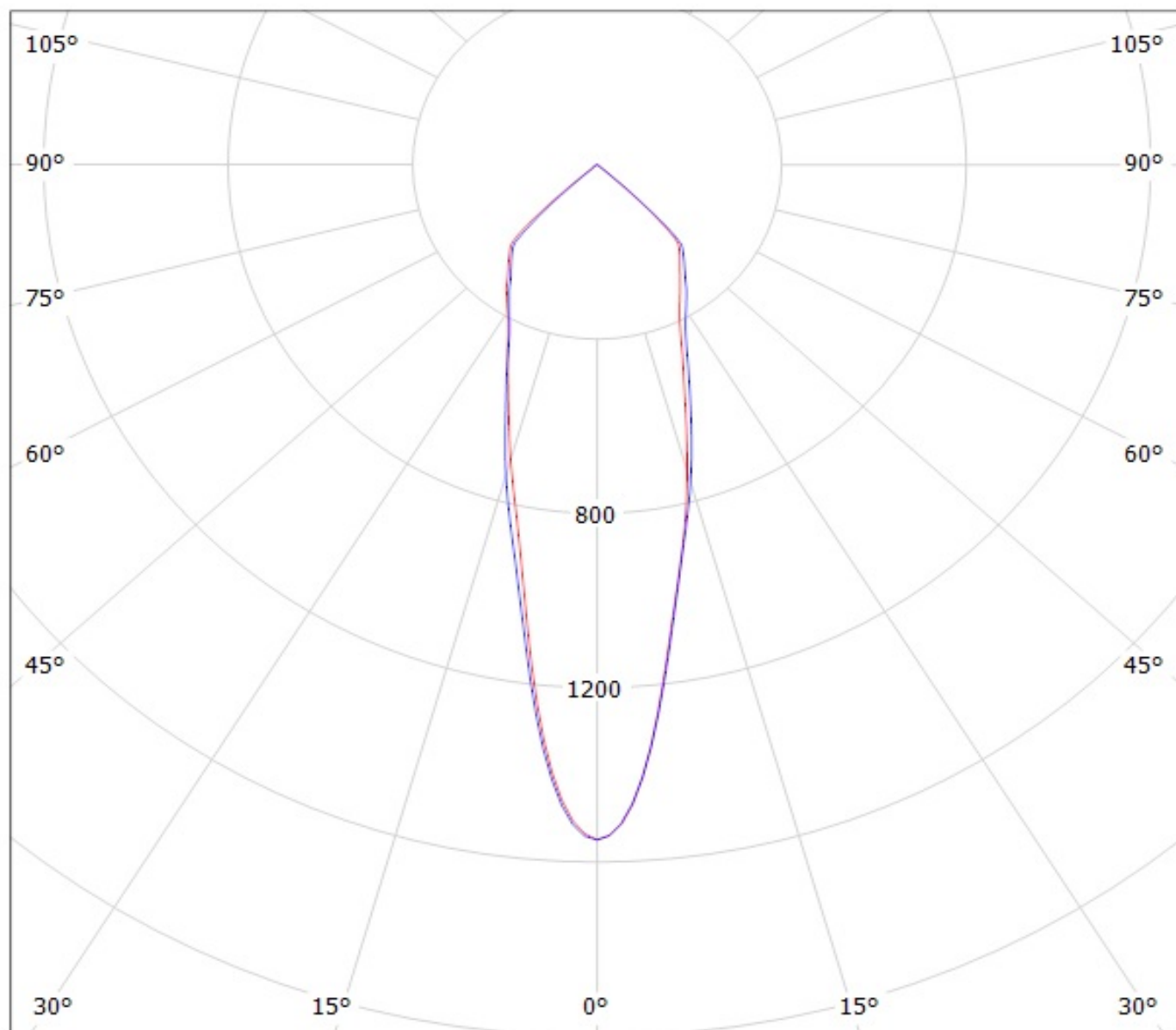

cd/klm

— C0 - C180

— C90 - C270

$\eta = 92\%$

Luminaire: LEDiL Oy FCN13695_ANGELINA-M_(LUXEON_CoB_1203)_ (438_Typ_L1)_ (C13658_CLAMP-VERO13-18)
Lamps: 1 x LUXEON_CoB_1203_(438_Typ_L1)_ (C13658_CLAMP-VERO13-18)_984.561lm@250mA_P=8.6828W_I=0.25A

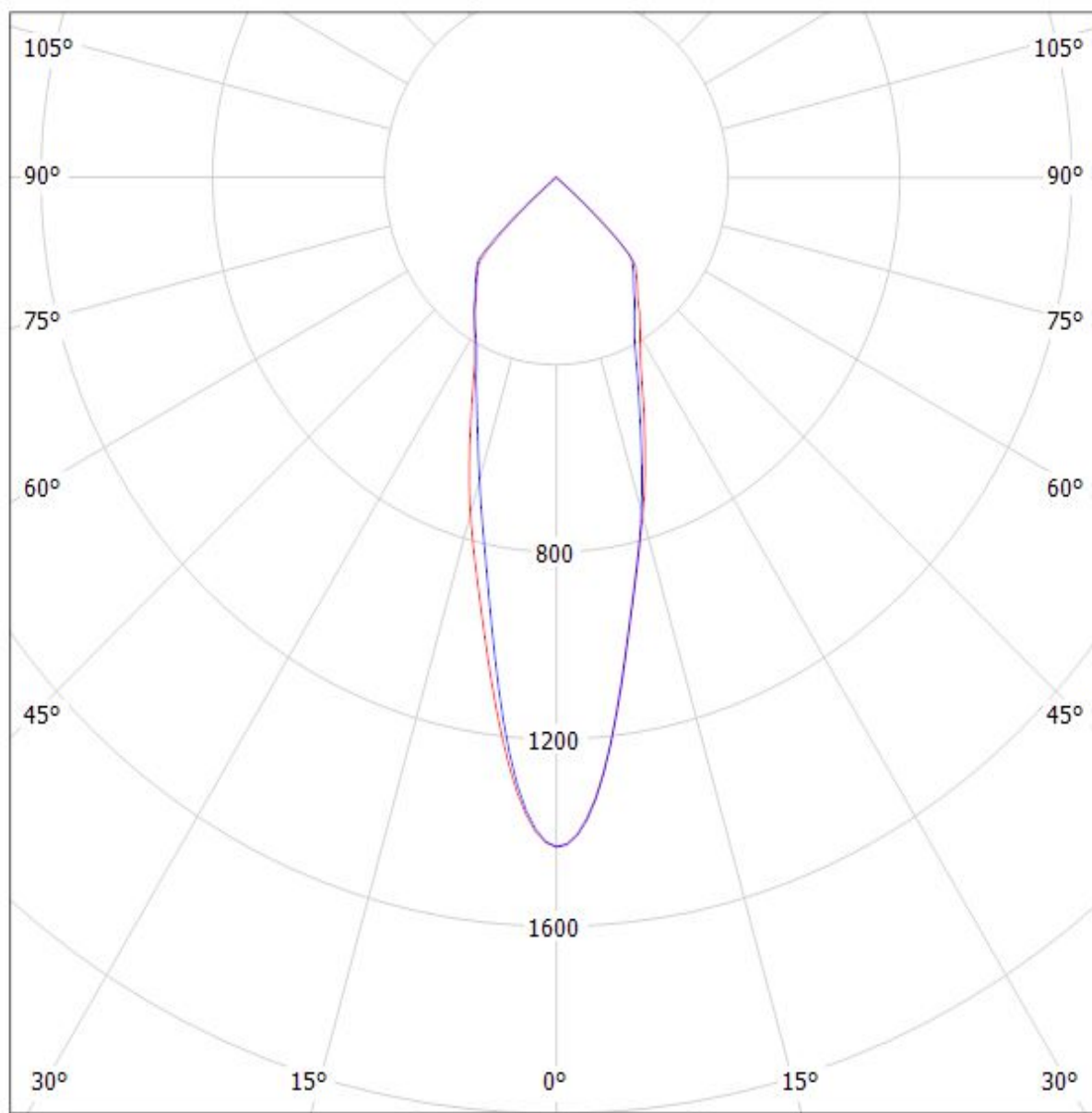

cd/klm

$\eta = 92\%$

— C0 - C180 — C90 - C270

Luminaire: LEDiL Oy FCN13695_ANGELINA-M_(NFDxJ130B)

Lamps: 1 x Nichia_NFDxJ130B_(463 Typ L2)_C13658_CLAMP-VERO13-18_1458.51lm@250mA_P=8.87739W_I=0.2498A

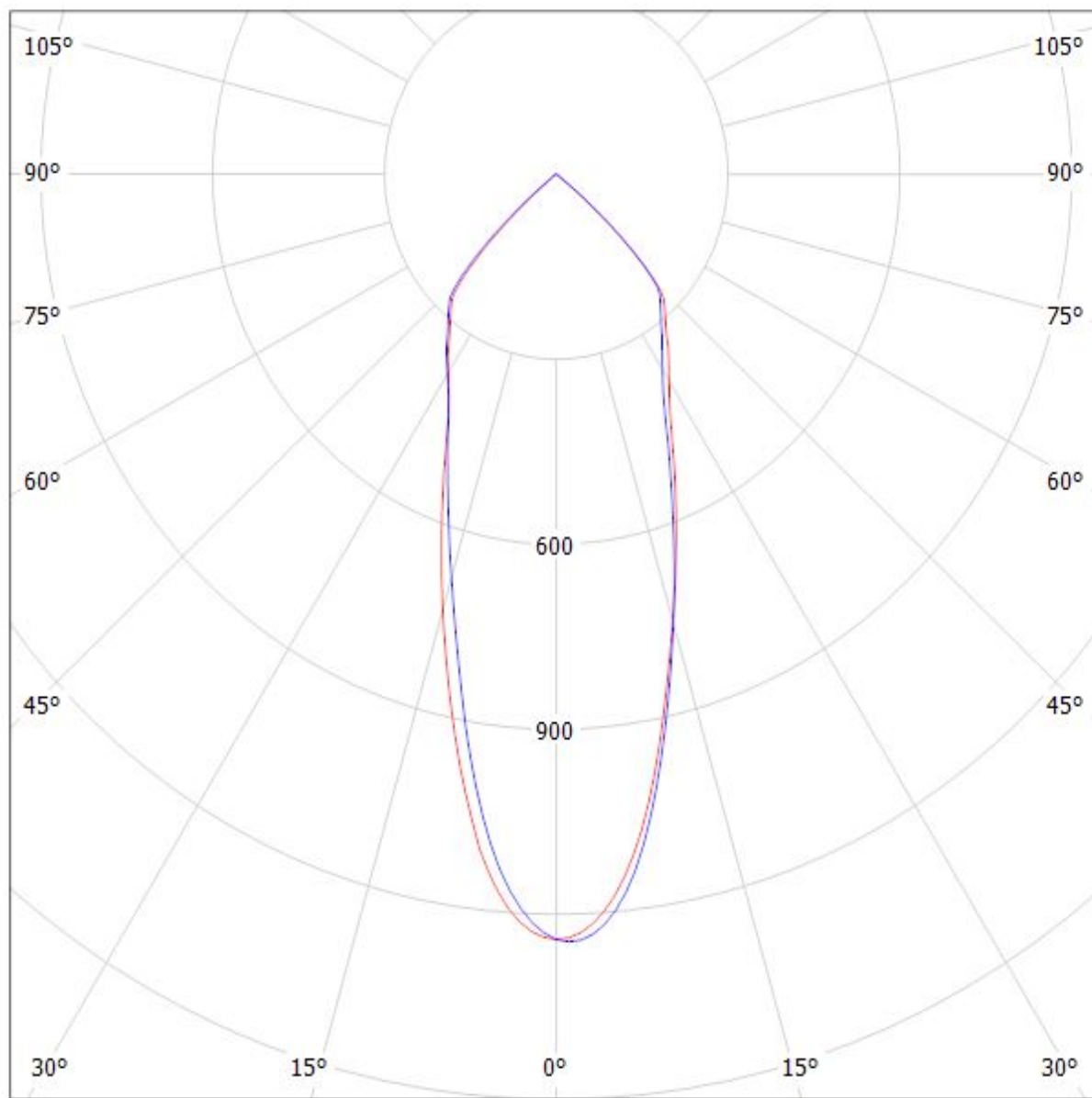

cd/klm

— C0 - C180 — C90 - C270

$\eta = 92\%$

Luminaire: LEDiL Oy FCN13695_ANGELINA-M_(NFCxL060B)_(438_Typ_L1)
Lamps: 1 x Nichia_NFCxL060B_(SM403G2450R8000)_(C13658)_(438_Typ_L1)_1298.52@250mA_P=8.45498W_η=0.2498A

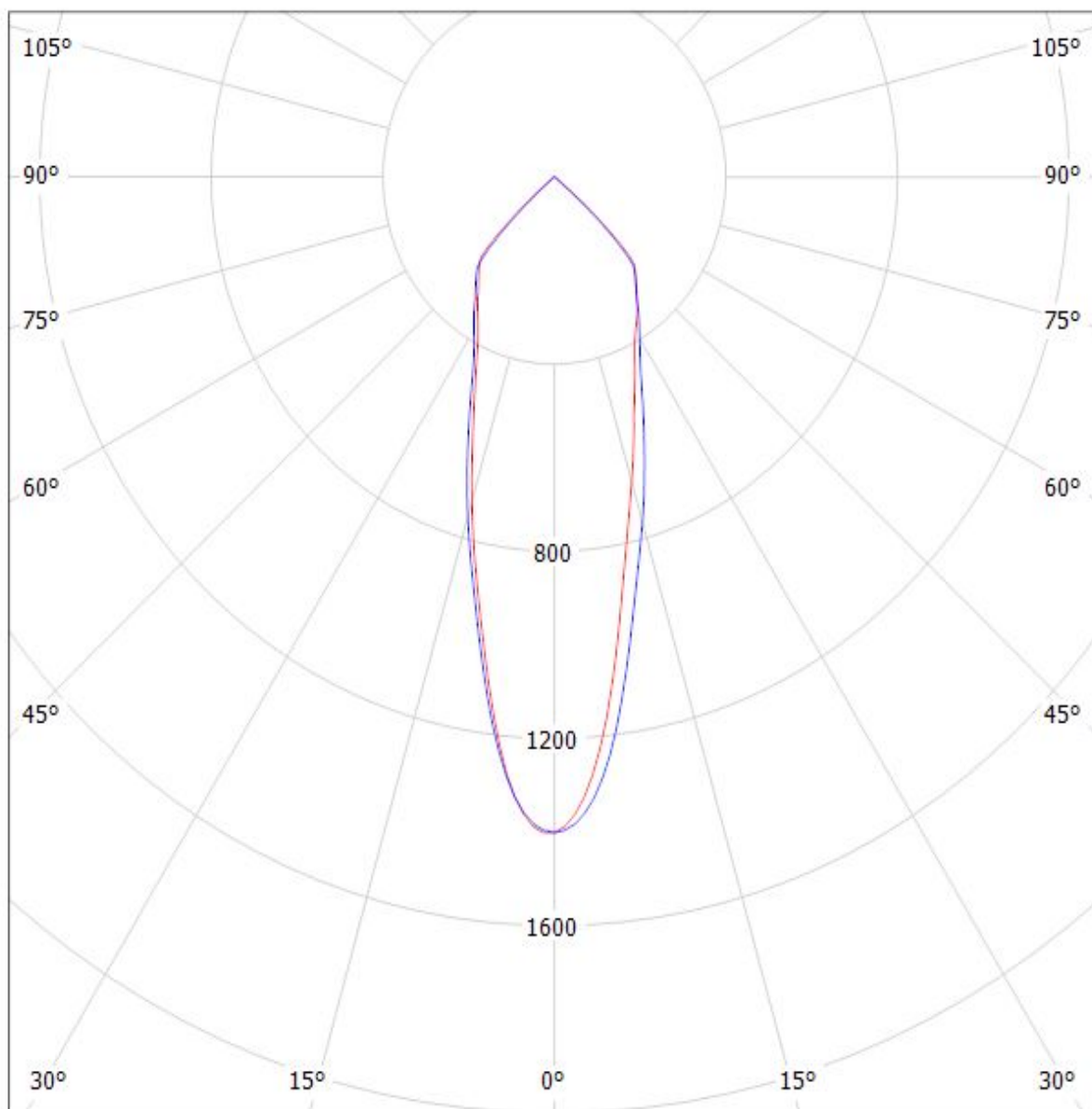

cd/klm

— C0 - C180 — C90 - C270

η = 92%

Luminaire: Ledil FCN13695_ANGELINA-M_(Soleriq_P9)_+_Bender+Wirth_461

Lamps: 1 x Osram_Soleriq_P9_(GW_MAFJB1.EM)_895.446lm@250mA_CCT=4299K_P=6.9W_I=0.25A

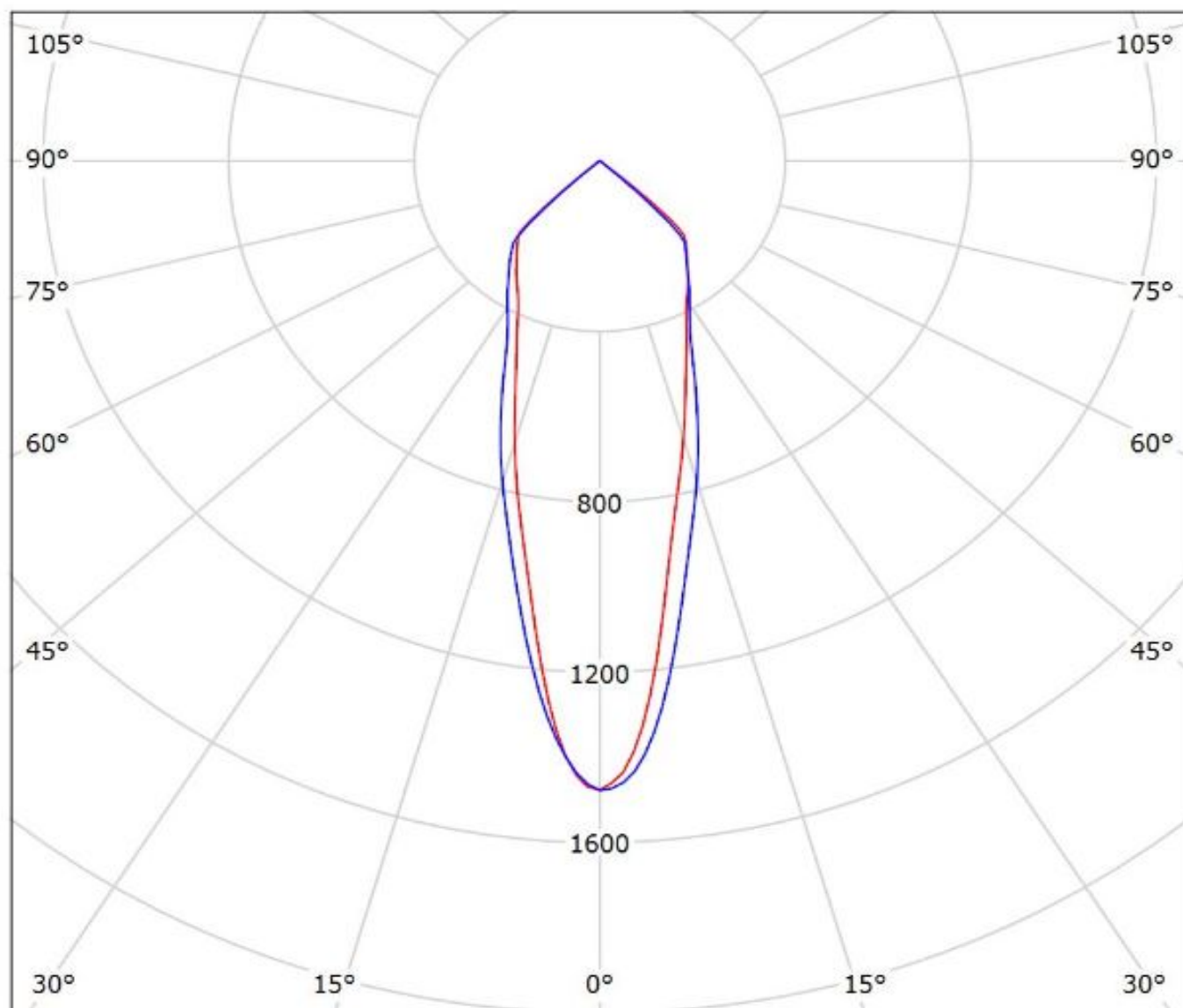

cd/klm

— C0 - C180 — C90 - C270

$\eta = 92\%$

Luminaire: Ledil FCN13695_ANGELINA-M_(Soleriq_P13)

Lamps: 1 x Osman_Soleriq_P13_1009.11lm@250mA_P=6.9385W_I=0.25A

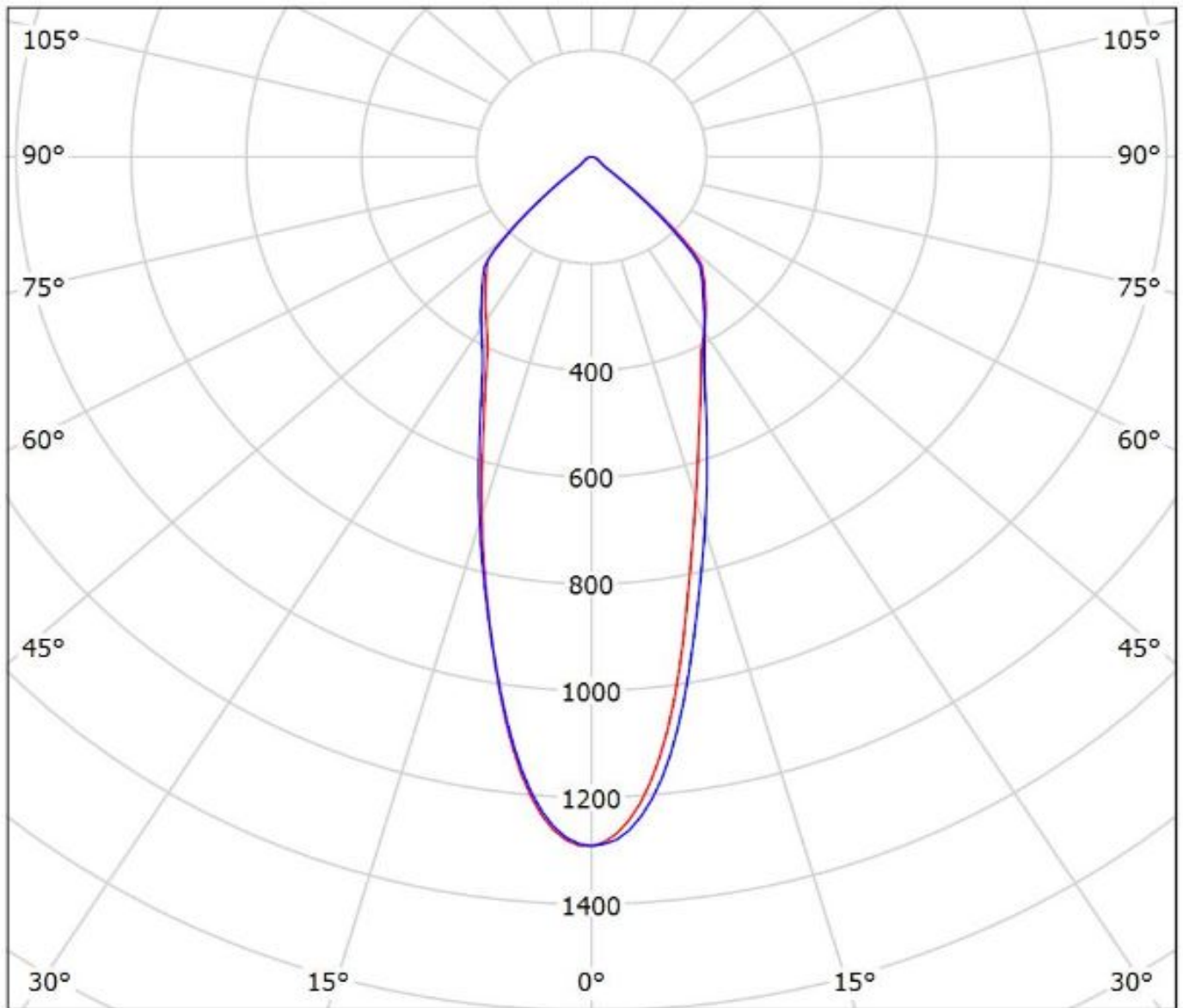

cd/klm

— C0 - C180 — C90 - C270

$\eta = 94\%$

Ledil FCN13695_ANGELINA-M_(Soleriq_S13) / LDC (Polar)

Luminaire: Ledil FCN13695_ANGELINA-M_(Soleriq_S13)

Lamps: 1 x Osram_Soleriq_S13_(GW_KAGHB1.EM)_896.727lm@250mA_P=7.44679W_I=250mA

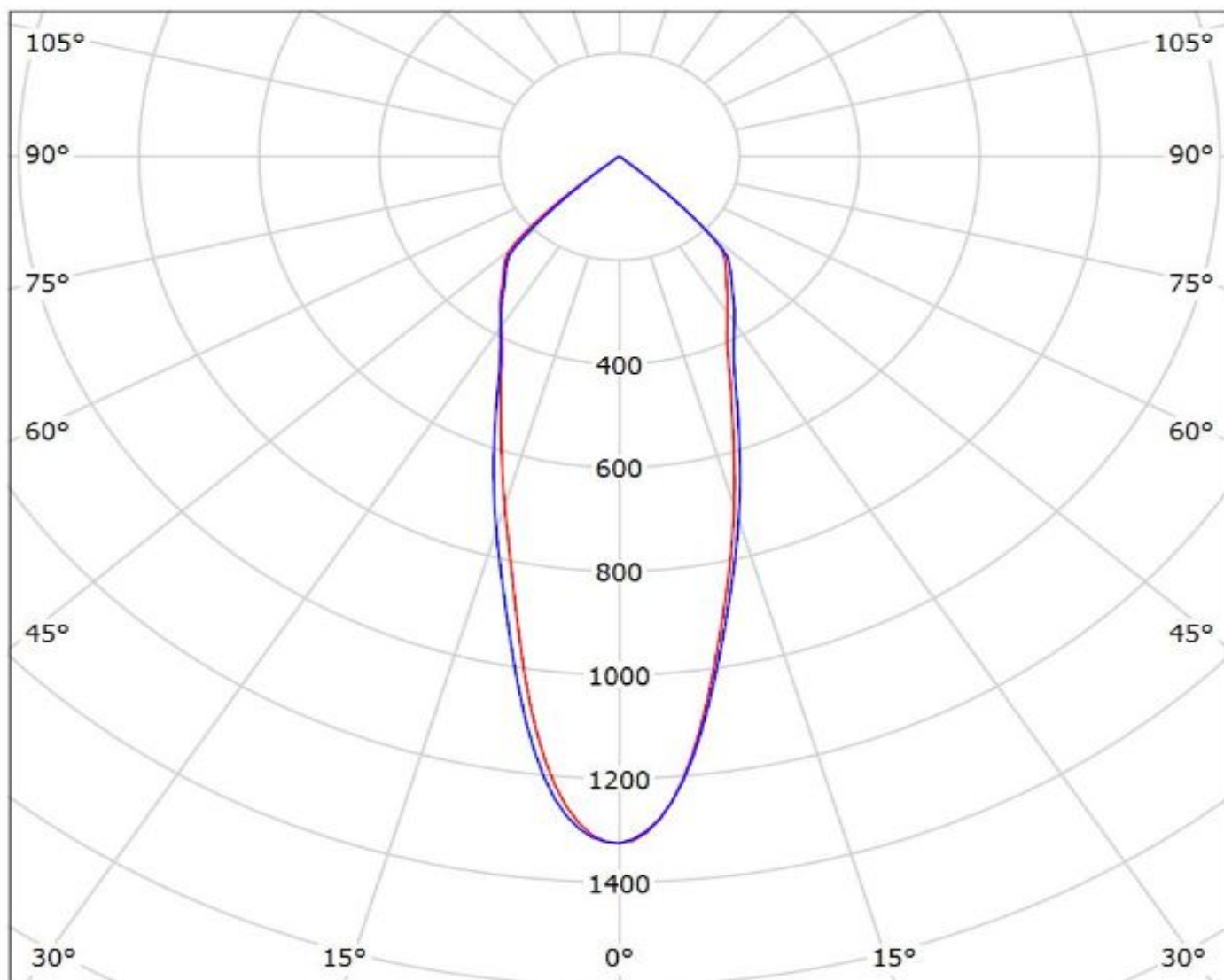

Luminaire: Ledil FCN13695_ANGELINA-M_(LC040B)_(450_Typ_L2)_(C13658_CLAMP-VERO13-18)
Lamps: 1 x Samsung_LC040B_CCT=3000K_(SPHWW1HDNE25010101)_(450_Typ_L2)_(C13658_CLAMP-VERO13-18)_1103.62lm@250mA_P=8.2W_I=0.25A

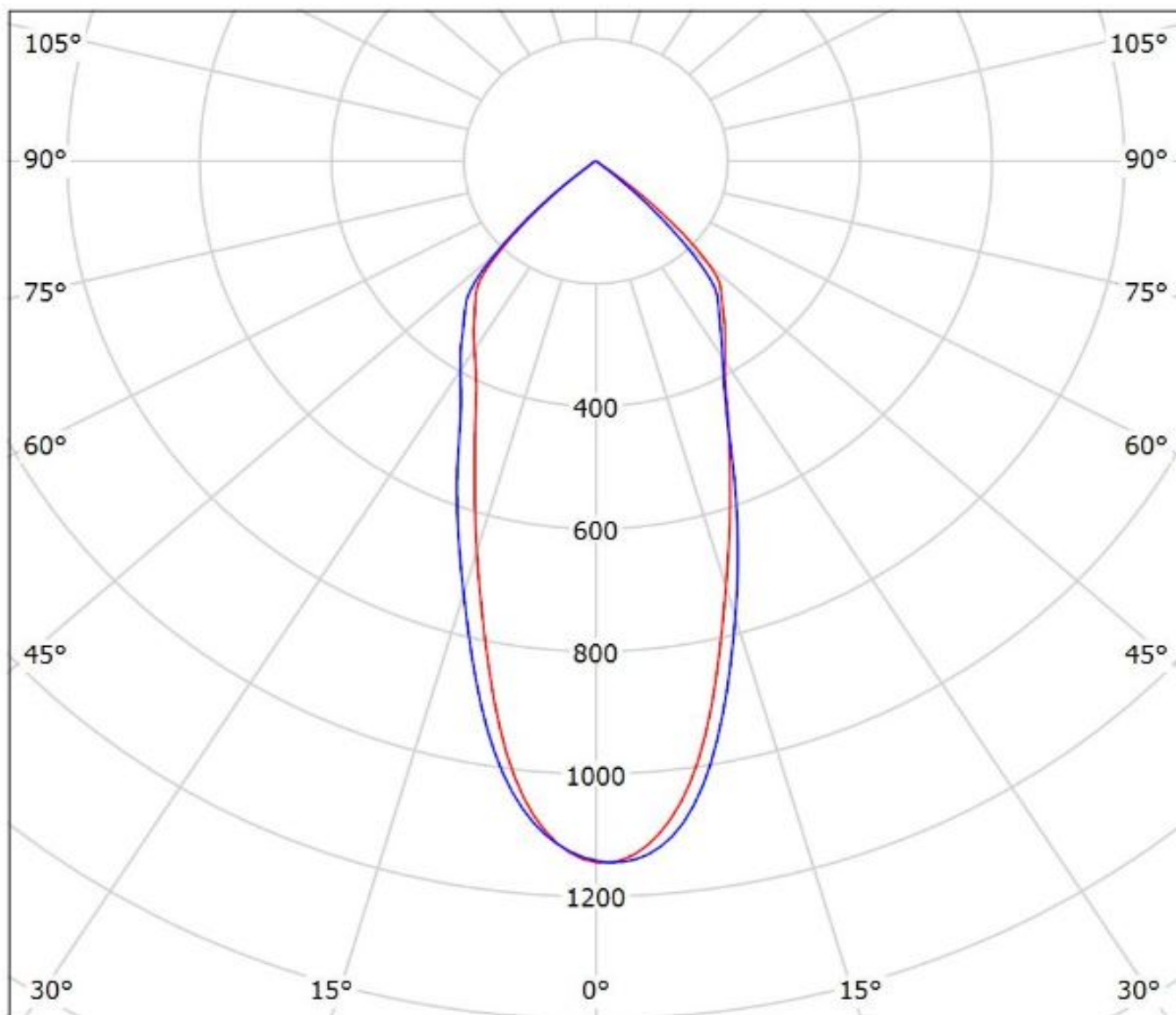

cd/klm
— C0 - C180 — C90 - C270

$\eta = 92\%$

Luminaire: LEDiL Oy FCN13695_ANGELINA-M_(SLE-G5_LES-11)

Lamps: 1 x Tridonic_SLE-G5_LES-11_1137.55lm@250mA_P=8.4177W_I=0.250A

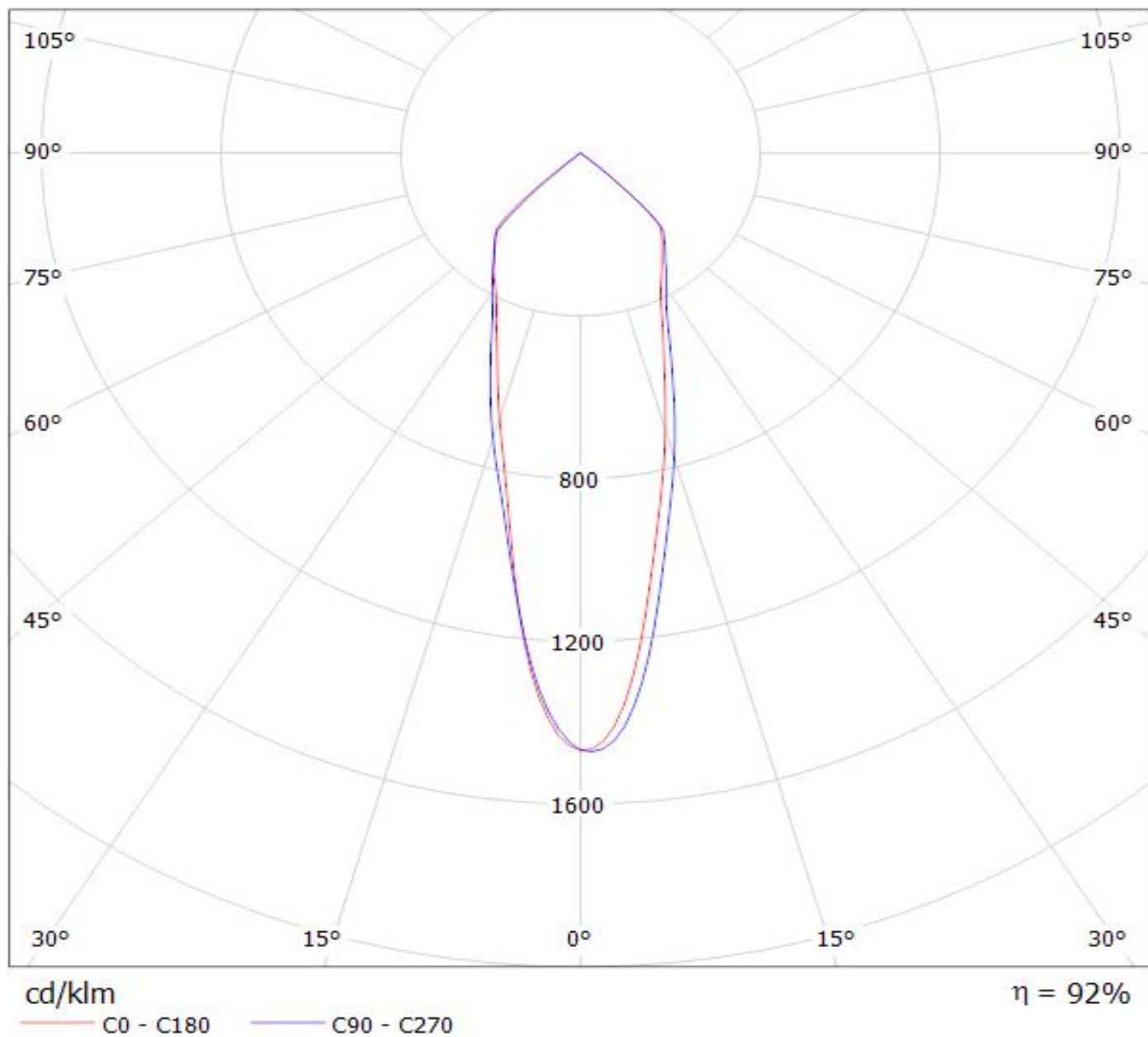

NOTE: The typical divergence will be changed by different color, chip size and chip position tolerance. The typical total divergence is the full angle measured where the luminous intensity is half of the peak value.

GENERAL INFORMATION

- Product series especially designed & optimized for series of LEDs.
- Special care taken to make light distribution as uniform as possible.

Note! Due to use of high power COB's with this product, special attention to proper thermal design is highly recommended. LEDiL has no liability for direct, indirect or consecutive damages arising from the LEDiL products being used outside of the recommended temperature range.