

Low Dropout High Performance Adjustable Positive Voltage Regulator

HIGH-RELIABILITY PRODUCTS

Features

- Wide input range, $V_{IN} = 1.25V$ to $16V$
 $V_{CNTL} = 3V$ to $16V$
- 3A guaranteed output current
- 260mV (typ.) @ 3A dropout voltage in dual supply mode
- 1% initial accuracy
- Adjustable output voltage down to 0.8V
- Programmable current limiting with thermal shutdown
- Fast transient response
- Excellent line and load regulation
- Military temperature range: $-55^{\circ}C$ to $+125^{\circ}C$
- The SC1592 voltage regulator is available in SOIC-8L EDP package
- Pb-free, halogen free, RoHS / WEEE compliant

Description

The SC1592 is a 3A low dropout high performance linear voltage regulator that provides a low voltage, high current output with a minimum of external components, utilizing dual supply configuration.

The SC1592 offers a wide input voltage range from 1.25V to 16V and is ideal for applications that need to convert down to 0.8V.

Additionally, the SC1592 is fully protected with an externally programmable current limit, and thermal shutdown. Also, there is an EN input which enables or shuts down the device.

Applications

- Low voltage logic supplies
- Microcontroller supplies
- Post regulation

Typical Application Circuit

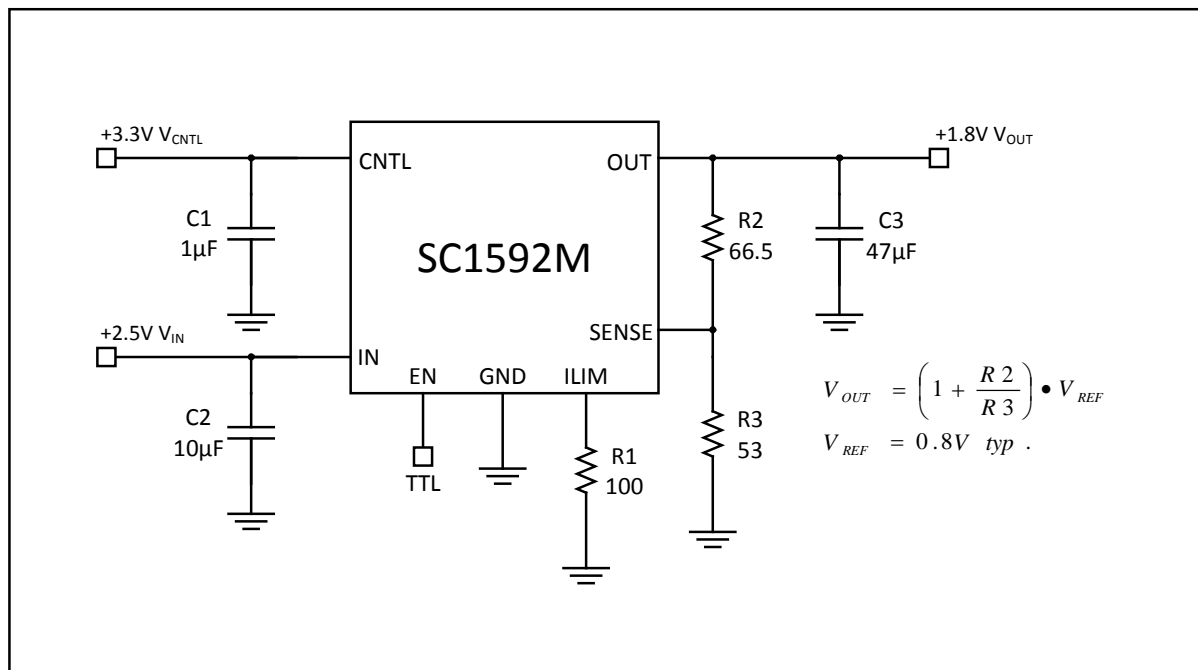

Absolute Maximum Ratings

Exceeding the specifications below may result in permanent damage to the device, or device malfunction. Operation outside of the parameters specified in the Electrical Characteristics section is not implied.

Parameter	Symbol	Maximum	Units
Power Input Voltage	V_{IN}	18	V
Control Input Voltage	V_{CNTL}	18	V
Output Current	I_{OUT}	5	A
Power Dissipation	P_D	Internally limited	W
Thermal Resistance Junction to Ambient	Θ_{JA}	36.5	°C/W
Thermal Resistance Junction to Case	Θ_{JC}	5.5	°C/W
Junction Temperature Range	T_J	-55 to +125	°C
Storage Temperature Range	T_{STG}	-65 to +150	°C
Lead Temperature (Soldering) 10 sec.	T_{LEAD}	300	°C
ESD Rating (Human Body Model)	ESD	2	kV

Electrical Characteristics

Unless otherwise specified: $V_{IN} = 2.5V$, $V_{EN} = V_{CNTL} = 3.3V$, $V_{OUT} = 1.8V$, $I_{OUT} = 10mA$, $R_{LIM} = 100\Omega$, $T_J = T_A = 25^\circ C$

Values in **bold** indicate $-55^\circ C < T_J < +125^\circ C$

Parameter	Symbol	Test Conditions	Min	Typ	Max	Units
Control Voltage	V_{CNTL}	$V_{OUT} = V_{REF}$	3		16	V
Reference Voltage	V_{REF}	$V_{OUT} = V_{REF}$	792	800	808	mV
Control Pin Current	I_{CNTL_EN}	$V_{CNTL} = V_{IN} = V_{EN} = 16$ $V_{OUT} = V_{REF}; I_{OUT} = 0A$		3	8	mA
		$V_{CNTL} = V_{IN} = V_{EN} = 16$ $V_{OUT} = V_{REF}; I_{OUT} = 3A$		24		
Control Pin Current in Shutdown	I_{CNTL_DIS}	$V_{CNTL} = V_{IN} = 16,$ $V_{EN} = 0V$		1	5	μA

Parameter	Symbol	Test Conditions	Min	Typ	Max	Units
V _{IN} Line Regulation	REG _(LINE)	2.5V ≤ V _{IN} ≤ 16V		0.01	0.1	%/V
V _{CNTL} Line Regulation	REG _(CNTL)	3.3V ≤ V _{CNTL} ≤ 16V V _{OUT} = V _{REF}		0.1	0.4	%/V
Load Regulation ⁽¹⁾	REG _(LOAD)	10mA ≤ I _{OUT} ≤ 2A, T _J = 25°C		0.8	1.5	%
		10mA ≤ I _{OUT} ≤ 3A, -55°C ≤ T _J ≤ +125°C		1.4	3	
Dropout Voltage	V _{DD}	I _{OUT} = 2A; V _{OUT} = 0.98V _{nom}		160	320	mV
		I _{OUT} = 3A; V _{OUT} = 0.98V _{nom}		260	520	
Thermal Shutdown	T _{SHUT}			150		°C
Thermal Shutdown Hyst.				10		°C
SENSE Input Current				1		μA
Low Level EN					0.8	V
High Level EN			2			V
EN Input Current		V _{EN} = V _{CNTL} = 5V		55	100	μA
EN Impedance				65		kΩ
Current Limit Accuracy ⁽²⁾	I _{LIM}		-20		+20	%

Notes:

(1) For load regulation use a 1ms current pulse width, d.c. ≤ 10% when measuring V_{out}

(2) Current limit is programmable, see page 4

Pin Configuration

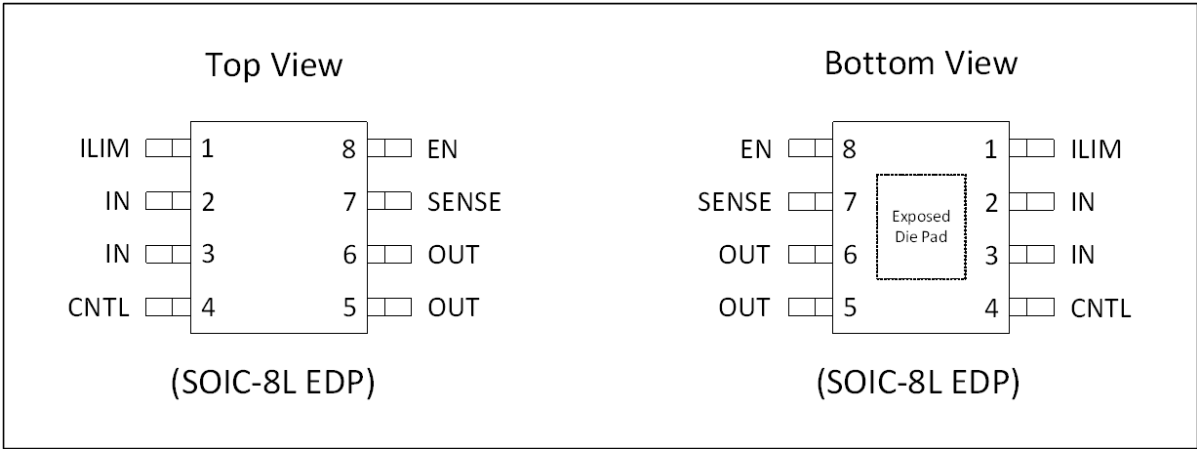

Ordering Information

Part Number	Package	Temp. Range (T _J)
SC1592MSTRT	SOIC-8L EDP	-55°C to +125°C

- (1) Available in tape and reel only. A reel contains 2,500 devices. Contact factory for smaller quantities.
- (2) Pb-free, halogen free, RoHS / WEEE compliant.

Device Marking

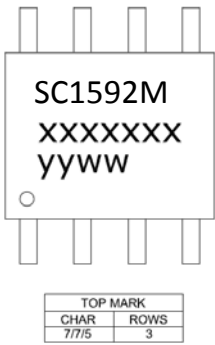

Marking for the SOIC EP 8 package:

- (1) SC1592M: part number;
- (2) xxxxxx: Semtech lot number;
- (3) yyww: date code

Pin Description

Pin #	Pin Name	Pin Function
1	ILIM	Externally programmable current limit should be set at < 5A.
2, 3	IN	This is the collector input to the power device. The output load current is supplied through this pin.
4	CNTL	This pin is the bias supply for the control circuitry. The current flow into this pin will be approximately 1% of the output current. For the device to regulate, the voltage on this pin must be at least 1.5V greater than the output voltage, but no less than V_{CNTL_MIN} .
5,6	OUT	This is the power output of the device.
7	SENSE	This is a feedback input.
8	EN	Enable input. When high, should be less than or equal to V_{CNTL} .
PAD	GND	Ground.

Block Diagram

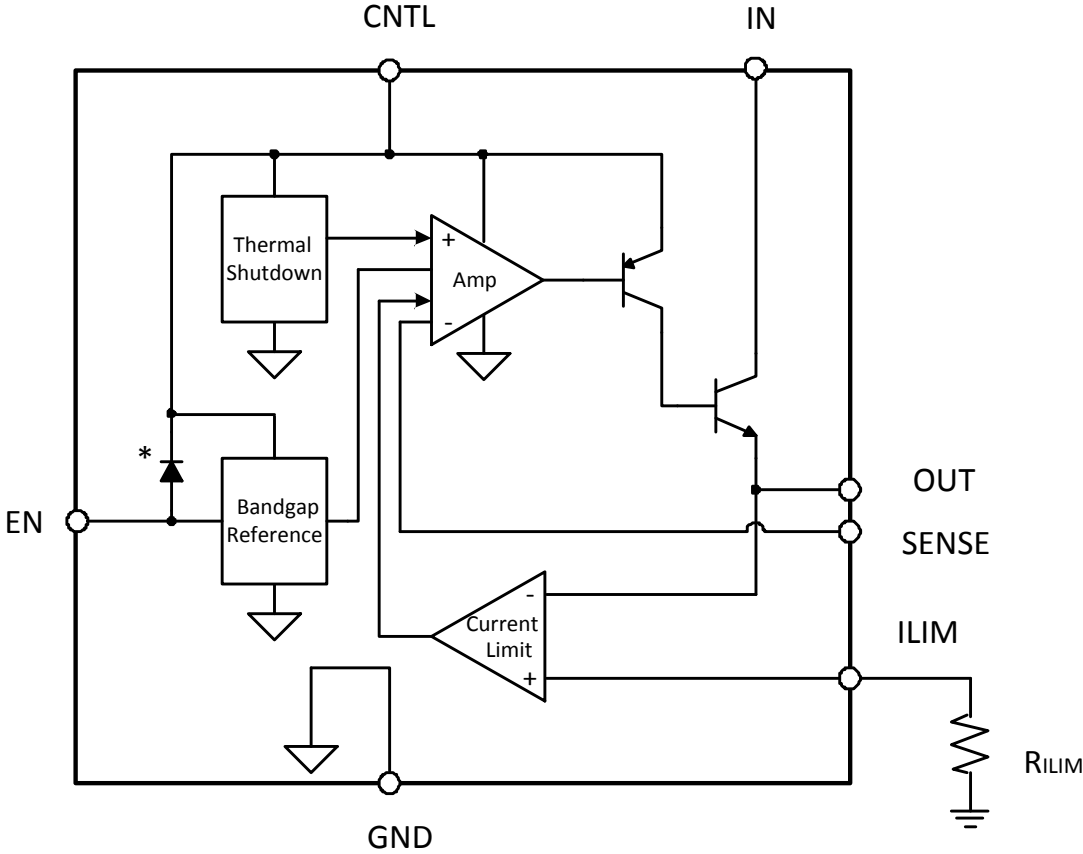

Figure 1

$$R_{LIM} \approx 240 \times \left[\frac{V_{OUT}}{I_{LIM}} \right]$$

I_{LIM} = Selected current limit value
 V_{OUT} = Regulated output voltage
 R_{LIM} = Externally programmable current limit resistor

Accuracy of the current limit setting is better than 20% over full operating temperature range.

* Internal ESD structure. In cases where EN is permanently tied to V_{IN}, it's recommended that a 10-20k resistor should be inserted in the link between EN and V_{IN}.

Description

The SC1592 is a 3A low dropout high performance linear voltage regulator. The SC1592 can be used for voltage applications as low as 0.8V and is ideal for down conversion utilizing dual supply configuration. This allows for extremely low dropout voltages with excellent load and line regulation. The SC1592 can be utilized in high voltage applications, with V_{IN} and V_{CNTL} up to 16V, providing there is adequate thermal management.

SC1592 is designed to meet stringent requirements of current generation microcontrollers and other sensitive electronic devices. This is possible by employing an additional bias source, V_{CNTL} . The voltage of this supply needs to be at least 1.5V greater than the output voltage in order to achieve low dropout, typically less than 300mV.

Unlike most of the other high current linear regulators, the SC1592 provides a programmable current limit which can be set with a single resistor. The value of the programming resistor is:

$$R_{LIM} \approx 240 \times \left[\frac{V_{OUT}}{I_{LIM}} \right]$$

where I_{LIM} = selected current limit value

V_{OUT} = regulated output voltage

R_{LIM} = programmable current limit resistor

The SC1592 has a fast transient response that allows it to handle large load changes associated with high current applications. Proper selection of the output capacitor and its ESR value determines stable operation and optimizes performance.

The typical application shown in Figure 2 was tested with a wide range of different capacitors. The circuit was found to be unconditionally stable with capacitor values from 47 μ F to 330 μ F and ESR ranging from 0.5m Ω to greater than 75m Ω .

It's recommended to maintain 5-10mA through the output divider network in order to have a tight load and line regulation. Initial accuracy of the internal voltage reference $V_{REF} = 0.8V \pm 1\%$ over full temperature range. This commands the use of 0.5% or better accuracy resistors to build a precision power supply.

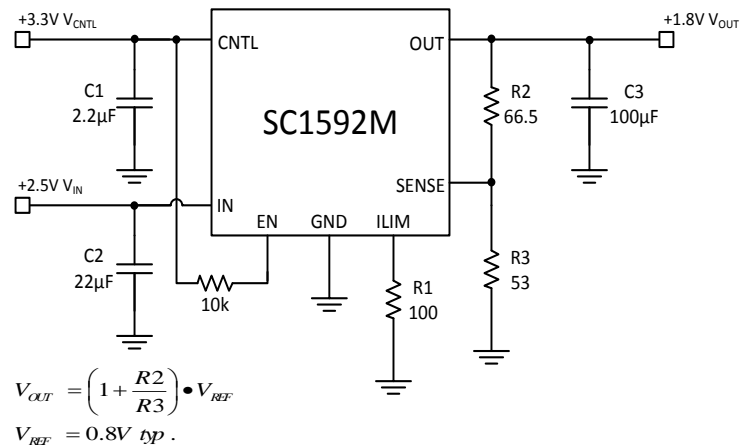

Figure 2

The circuit in Figure 2 shows a typical application of 2.5V to 1.8V conversion with a 3.3V control supply and the load range of up to 3A steady state. Considering the approximate 2W power being dissipated by the pass element of the SC1592, we are still able to choose an SO-8 EDP package with $T_{JA} = 36.5^{\circ}C/W$ mounted on a 1sq. in. copper pad allocated for adequate heat transfer. The ambient temperature in this case should not exceed 50 $^{\circ}C$.

Input capacitor: A minimum of 10 μ F ceramic capacitor is recommended to be placed directly next to the V_{in} pin. This allows for the device being some distance from any bulk capacitance on the rail. Additionally, bulk capacitance may be added close to the input supply pin of the SC1592 to ensure that V_{in} does not sag, improving load transient response.

Output capacitor: A minimum bulk capacitance of 33 μ F, along with a 0.1 μ F ceramic decoupling capacitor is recommended. Increasing the bulk capacitance will improve the overall transient response. The use of multiple lower value ceramic capacitors in parallel to achieve the desired bulk capacitance will not cause stability issues. Although designed for use with ceramic output capacitors, the SC1592 is extremely tolerant of output capacitor ESR values and thus will also work comfortably with electrolytic output capacitors.



Typical Characteristics

Load Transient Response

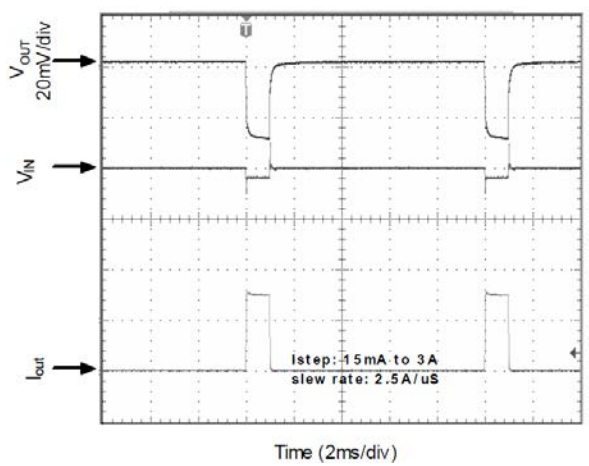

Load Transient Response

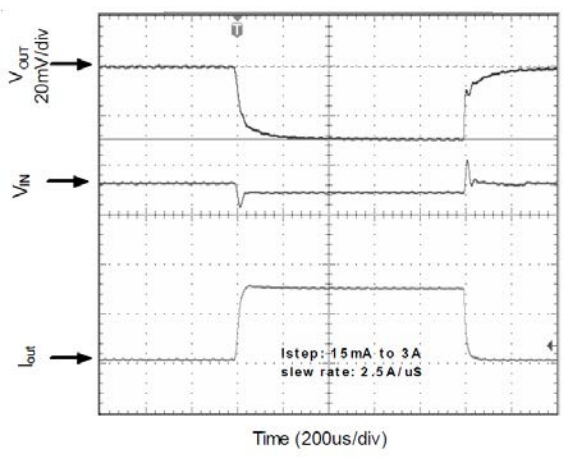

Load Regulation

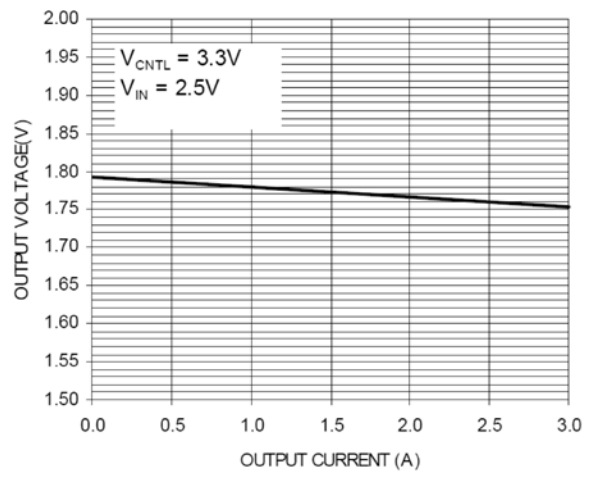

Dropout Voltage (Control Supply)

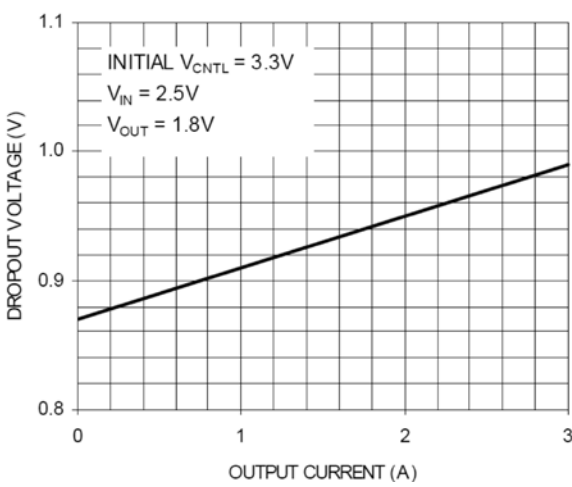

Dropout Voltage (Input Supply)

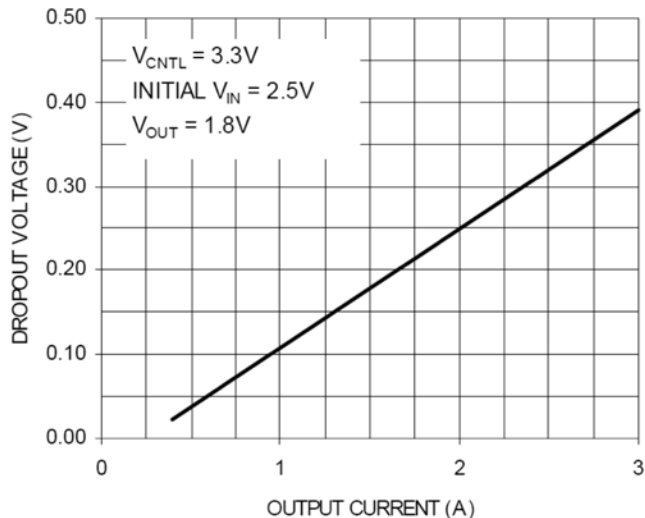



Typical Characteristics (Cont.)

Output Voltage vs Temperature

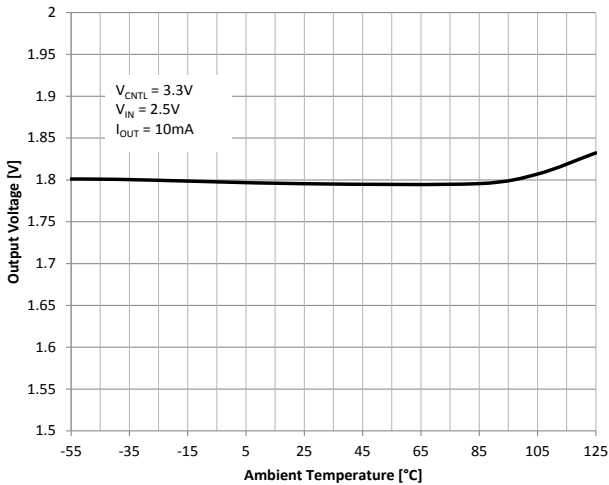

Enable Threshold vs Temperature

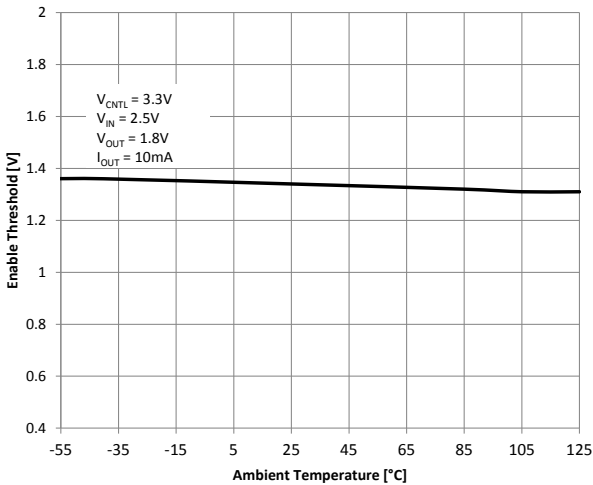

Control Current vs Temperature (In Regulation)

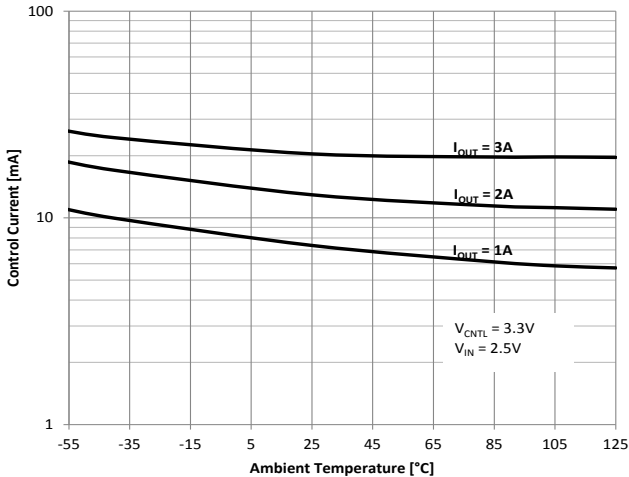

Control Current vs Temperature (In Shutdown)

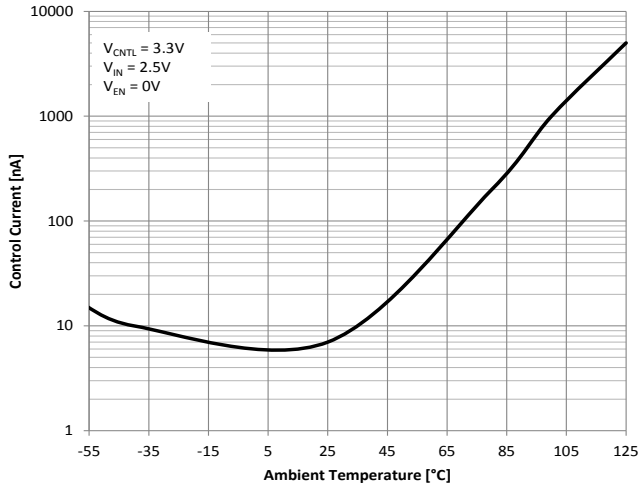

Dropout Voltage vs Temperature ($V_{CTL} - V_{OUT}$)

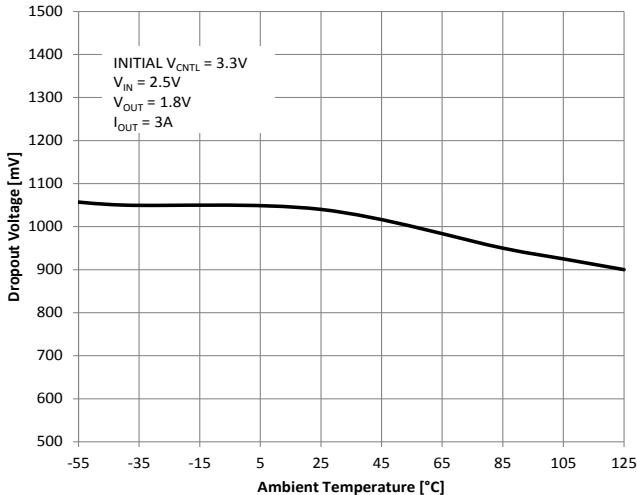

Dropout Voltage vs Temperature ($V_{IN} - V_{OUT}$)

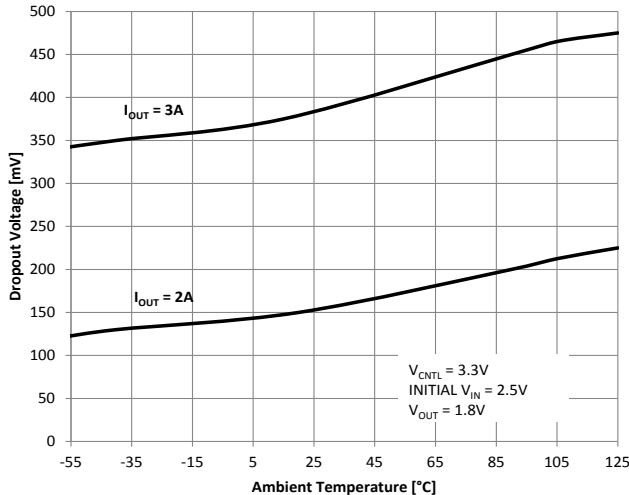



Typical Characteristics (Cont.)

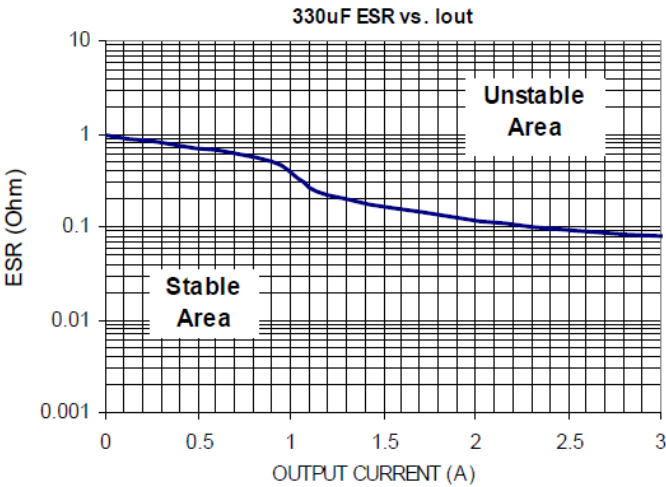
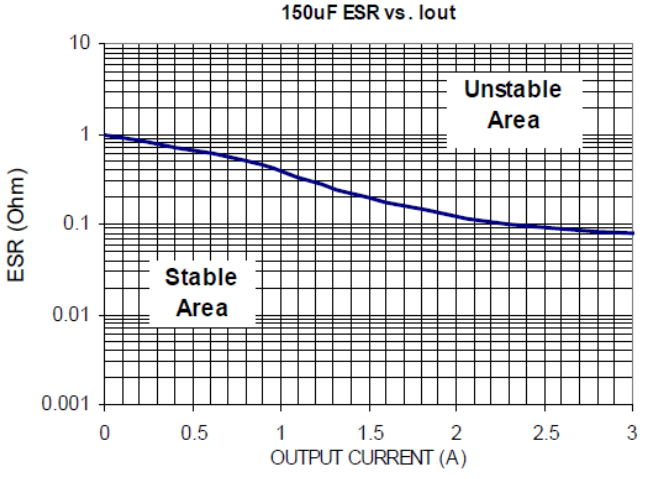
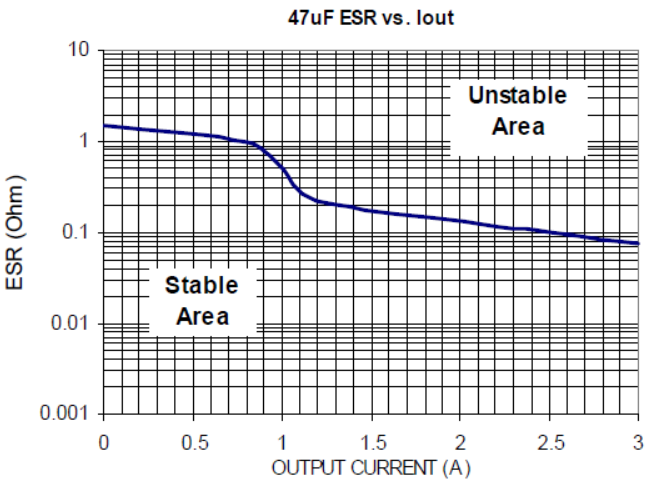



Outline Drawing – SOIC-8L EDP

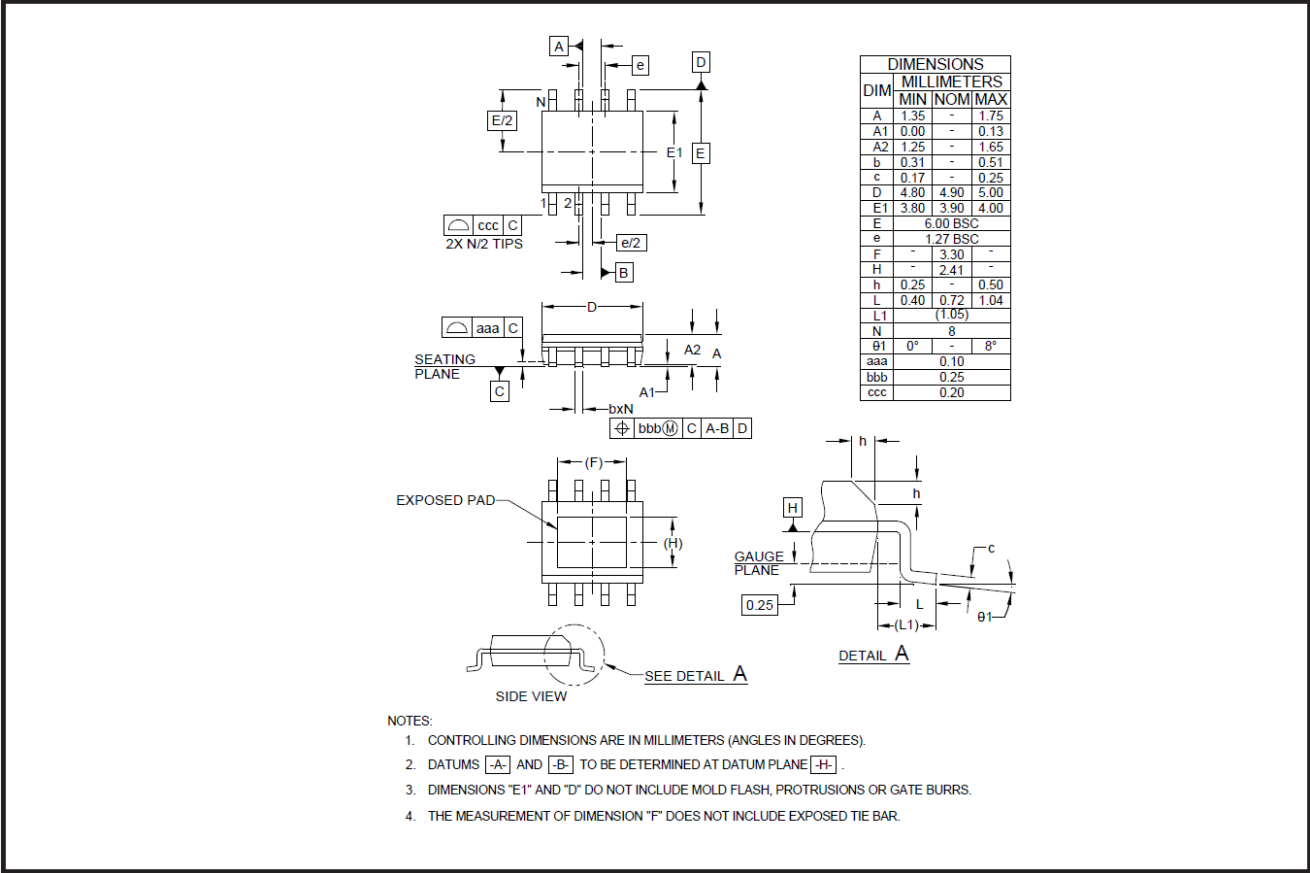

Landing Pattern – SOIC-8L EDP

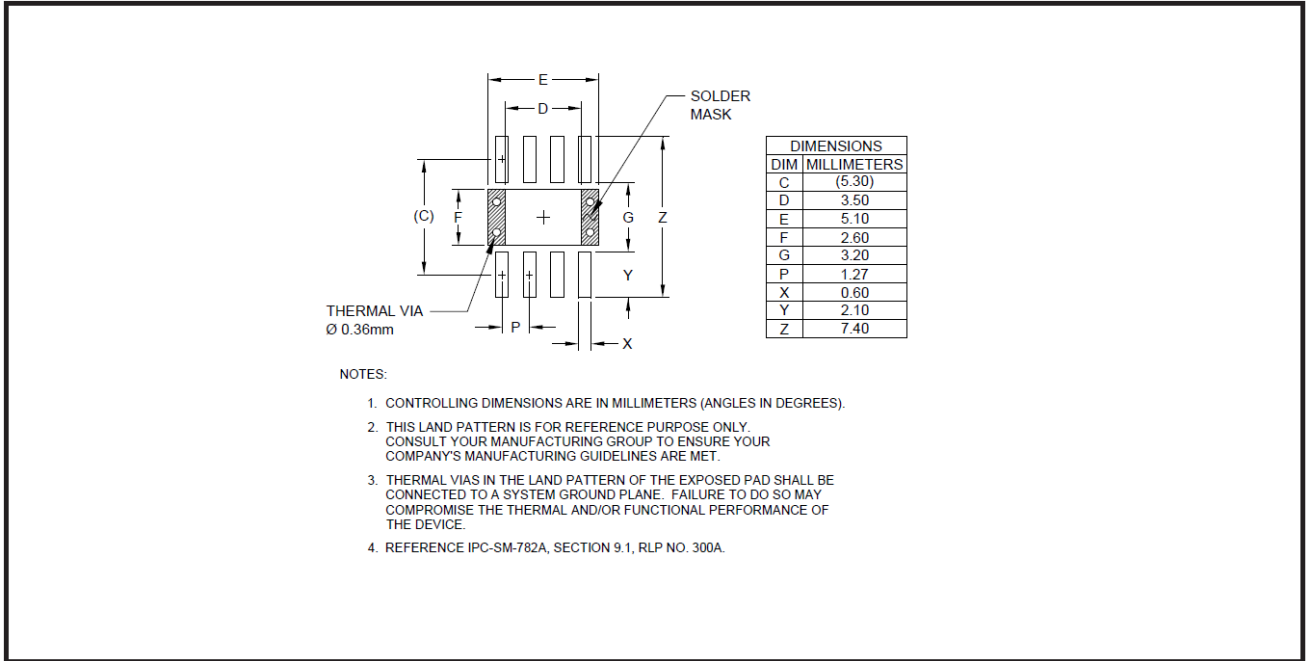



© Semtech 2017

All rights reserved. Reproduction in whole or in part is prohibited without the prior written consent of the copyright owner. The information presented in this document does not form part of any quotation or contract, is believed to be accurate and reliable and may be changed without notice. No liability will be accepted by the publisher for any consequence of its use. Publication thereof does not convey nor imply any license under patent or other industrial or intellectual property rights. Semtech assumes no responsibility or liability whatsoever for any failure or unexpected operation resulting from misuse, neglect improper installation, repair or improper handling or unusual physical or electrical stress including, but not limited to, exposure to parameters beyond the specified maximum ratings or operation outside the specified range.

SEMTECH PRODUCTS ARE NOT DESIGNED, INTENDED, AUTHORIZED OR WARRANTED TO BE SUITABLE FOR USE IN LIFESUPPORT APPLICATIONS, DEVICES OR SYSTEMS OR OTHER CRITICAL APPLICATIONS. INCLUSION OF SEMTECH PRODUCTS IN SUCH APPLICATIONS IS UNDERSTOOD TO BE UNDERTAKEN SOLELY AT THE CUSTOMER'S OWN RISK. Should a customer purchase or use Semtech products for any such unauthorized application, the customer shall indemnify and hold Semtech and its officers, employees, subsidiaries, affiliates, and distributors harmless against all claims, costs damages and attorney fees which could arise.

Notice: All referenced brands, product names, service names and trademarks are the property of their respective owners.