

BARBARA-XW-PF

White version with ~75° wide beam

TECHNICAL SPECIFICATIONS:

Dimensions	Ø 70 mm
Height	41.7 mm
Fastening	socket
Colour	white
Box size	480 x 280 x 300 mm
Box weight	8.4 kg
Quantity in Box	288 pcs
ROHS compliant	yes ⓘ

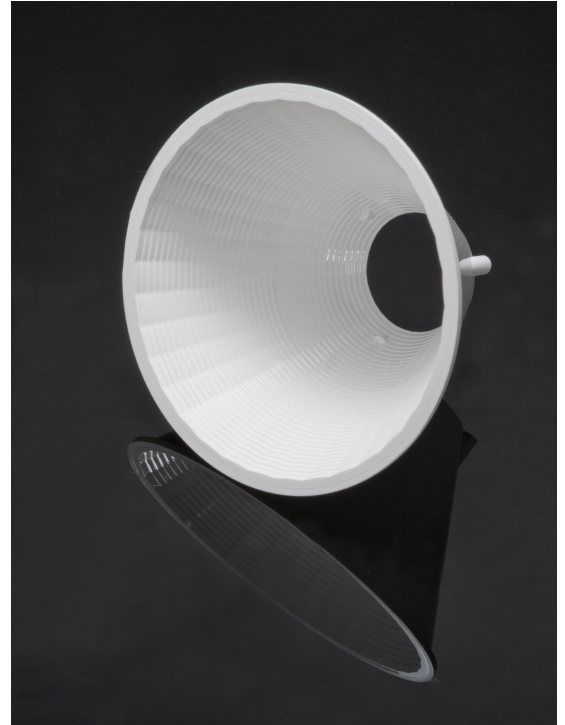

MATERIAL SPECIFICATIONS:

Component	Type	Material	Colour	Coating
BARBARA-XW-PF	Reflector	HRPC	white	

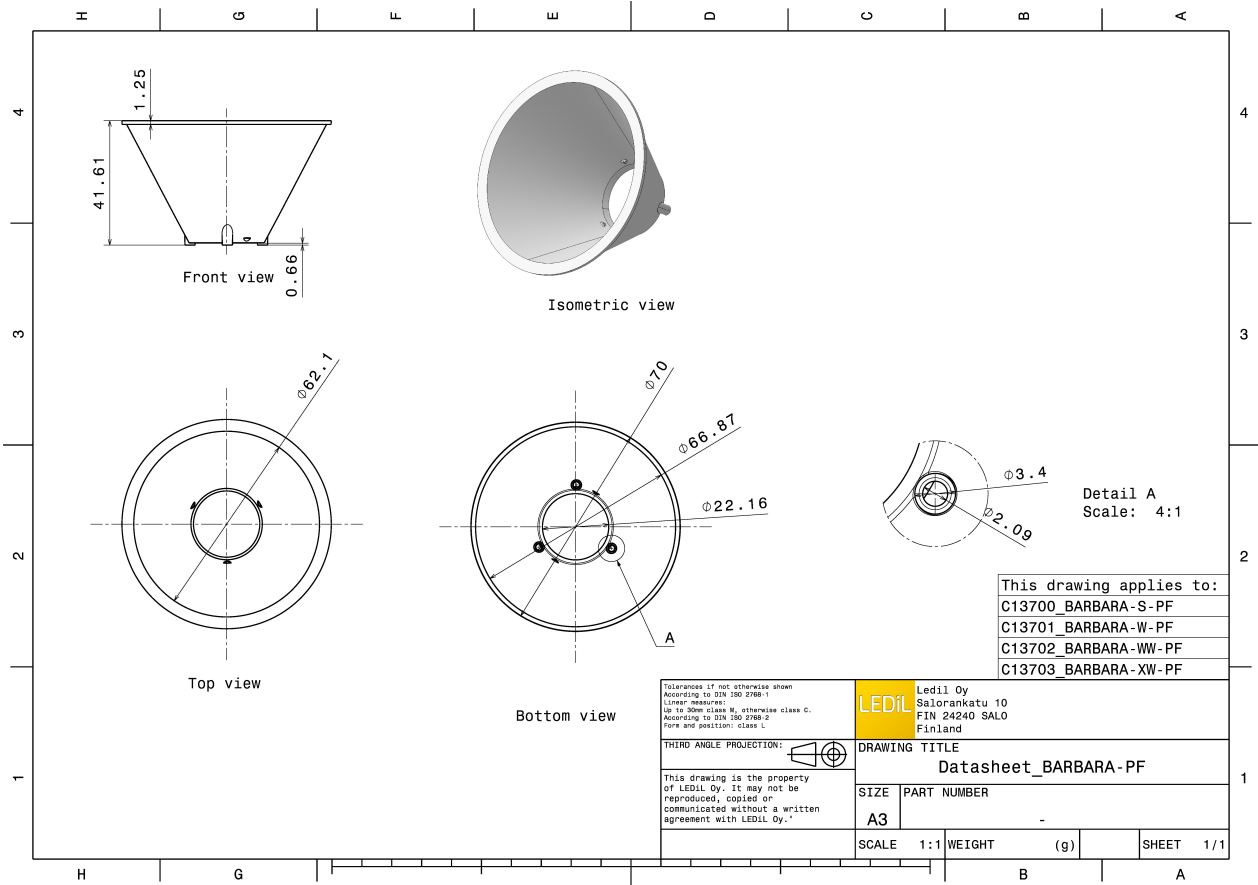

PHOTOMETRIC DATA (MEASURED):

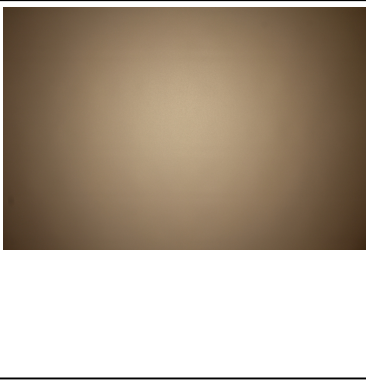
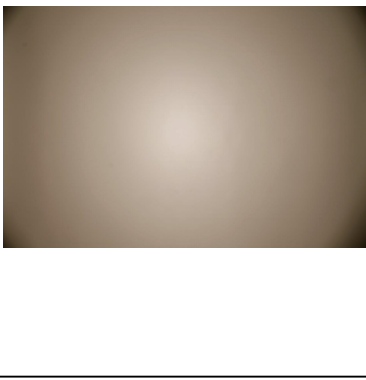
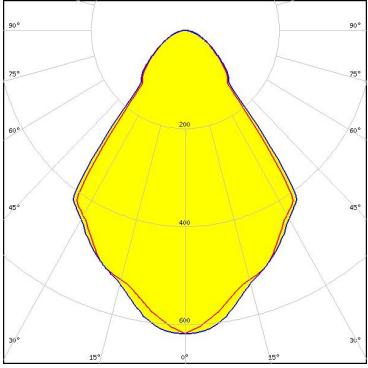
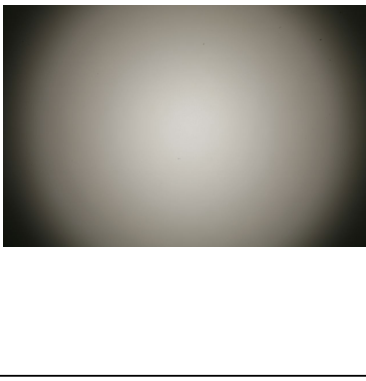
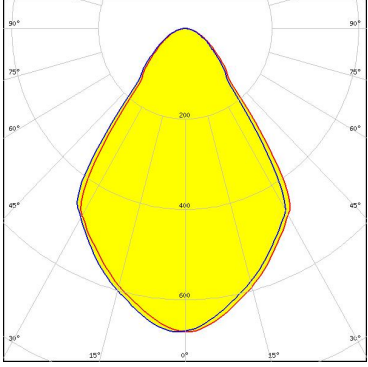
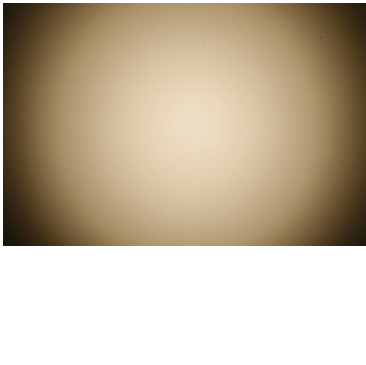
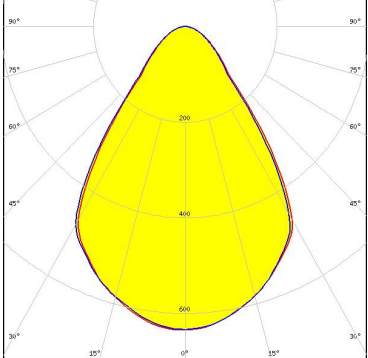
<p>bridgelux.</p> <p>LED V15 Gen6</p> <p>FWHM 71.0°</p> <p>Efficiency 89 %</p> <p>Peak intensity 0.720 cd/lm</p> <p>Required components: C13709_PF-SOCKET-VERO13-18 Bender Wirth: 456 Typ L2</p>		
<p>bridgelux.</p> <p>LED V8 Gen6</p> <p>FWHM 74.0°</p> <p>Efficiency 90 %</p> <p>Peak intensity 0.630 cd/lm</p> <p>Required components: C13761_PF-SOCKET-CXA15</p>		
<p>bridgelux.</p> <p>LED VERO13</p> <p>FWHM 72.0°</p> <p>Efficiency 93 %</p> <p>Peak intensity 0.670 cd/lm</p> <p>Required components: C13709_PF-SOCKET-VERO13-18</p>		
<p>bridgelux.</p> <p>LED VERO18</p> <p>FWHM 72.0°</p> <p>Efficiency 93 %</p> <p>Peak intensity 0.630 cd/lm</p> <p>Required components: C13709_PF-SOCKET-VERO13-18</p>		

PHOTOMETRIC DATA (MEASURED):

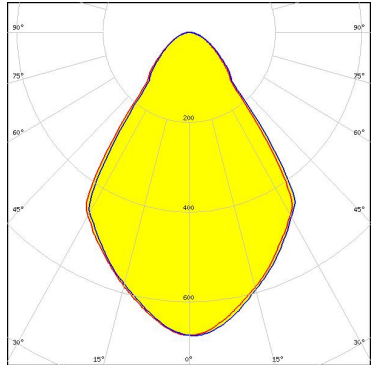
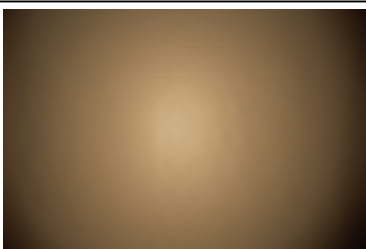
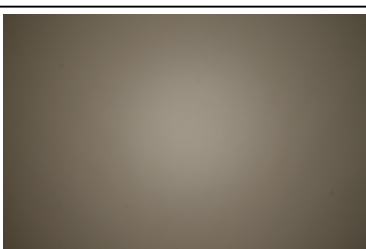
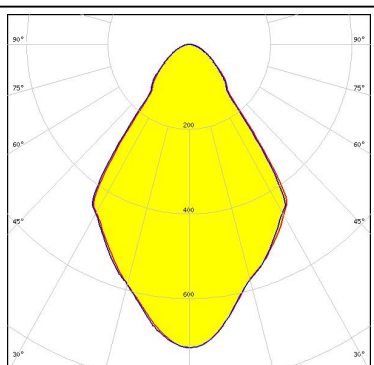
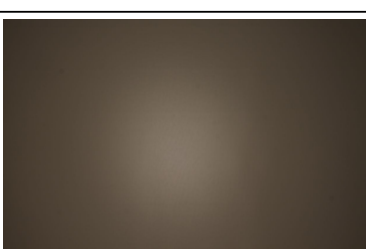
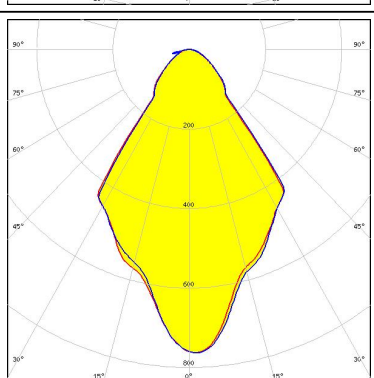
<p>bridgelux.</p> <p>LED Xenio Point 13mm</p> <p>FWHM 71.0°</p> <p>Efficiency 92 %</p> <p>Peak intensity 0.680 cd/lm</p> <p>Required components: C13709_PF-SOCKET-VERO13-18</p>		
<p>bridgelux.</p> <p>LED Xenio Point 18mm</p> <p>FWHM 72.0°</p> <p>Efficiency 91 %</p> <p>Peak intensity 0.640 cd/lm</p> <p>Required components: C13709_PF-SOCKET-VERO13-18</p>		
<p>CITIZEN</p> <p>LED CLL02x/CLU02x (LES10)</p> <p>FWHM 70.0°</p> <p>Efficiency 90 %</p> <p>Peak intensity 0.720 cd/lm</p> <p>Required components: C13709_PF-SOCKET-VERO13-18 Bender Wirth: 434 Typ L1</p>		
<p>CITIZEN</p> <p>LED CLU700/701</p> <p>FWHM 70.0°</p> <p>Efficiency 90 %</p> <p>Peak intensity 0.770 cd/lm</p> <p>Required components: C13709_PF-SOCKET-VERO13-18 Bender Wirth: 434 Typ L1</p>		

PHOTOMETRIC DATA (MEASURED):



LED CXA/B 15xx
FWHM 70.0°
Efficiency 90 %
Peak intensity 0.720 cd/lm
Required components:
C13709_PF-SOCKET-VERO13-18
Bender Wirth: 441 Typ L1

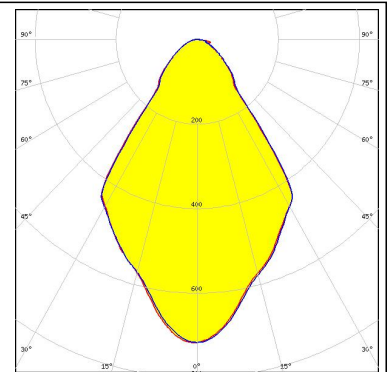
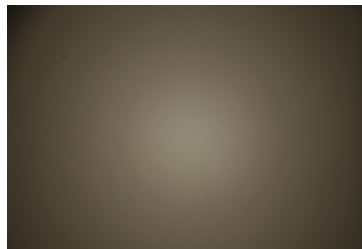

LED CXA/B 15xx
FWHM 73.0°
Efficiency 85 %
Peak intensity 0.600 cd/lm
Required components:
C13083_PF-SOCKET
C14658_BARBARA-RZ-LENS

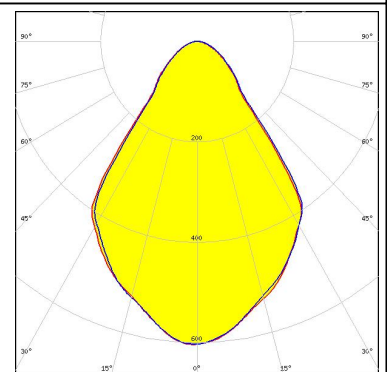
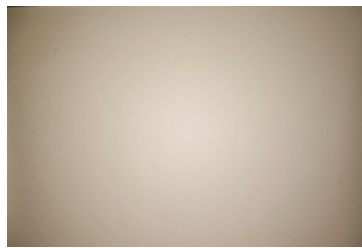

LED CXA/B 15xx
FWHM 70.0°
Efficiency 92 %
Peak intensity 0.760 cd/lm
Required components:
C14115_PF-SOCKET-CXA15-18

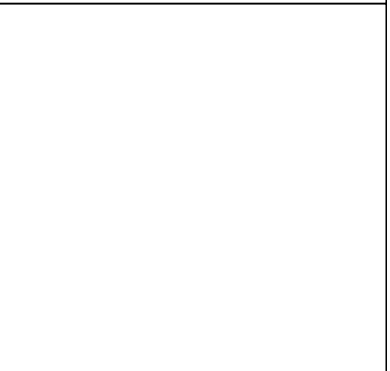

LED CXA/B 1816 & CXA/B 1820 & CXA 1850
FWHM 70.0°
Efficiency 93 %
Peak intensity 0.730 cd/lm
Required components:
C14115_PF-SOCKET-CXA15-18

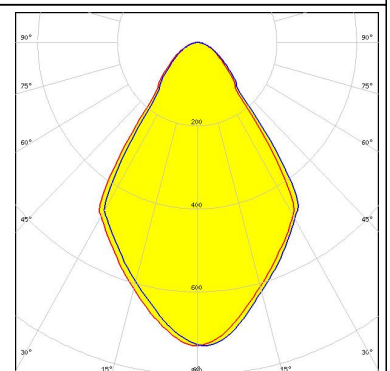
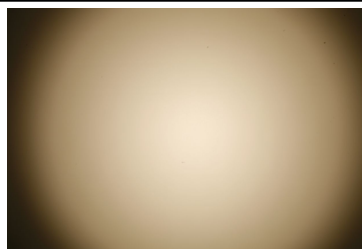

PHOTOMETRIC DATA (MEASURED):



LED CXA/B 1816 & CXA/B 1820 & CXA 1850
 FWHM 67.0°
 Efficiency 82 %
 Peak intensity 0.700 cd/lm
 Required components:
 C13709_PF-SOCKET-VERO13-18
 Bender Wirth: 437 Typ L1

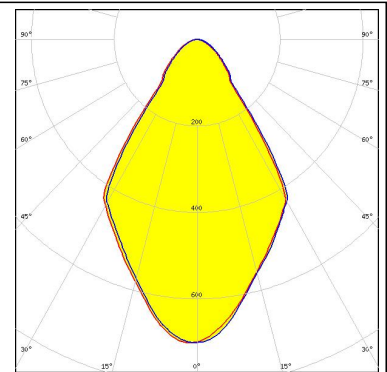
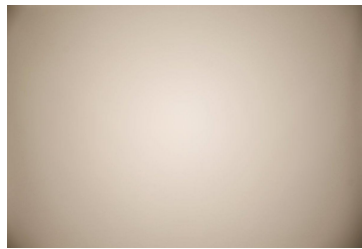

LED LUXEON CoB 1202/1203
 FWHM 71.0°
 Efficiency 92 %
 Peak intensity 0.720 cd/lm
 Required components:
 C14037_PF-NSX-SOCKET

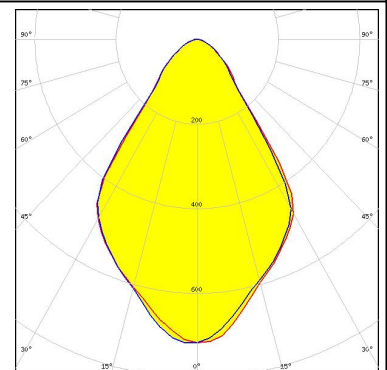
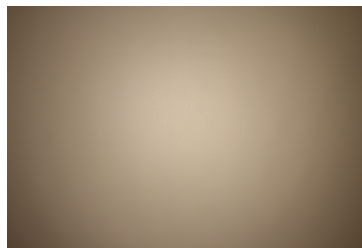

LED LUXEON CoB 1202/1203
 FWHM 71.0°
 Efficiency 90 %
 Peak intensity 0.710 cd/lm
 Required components:
 C13709_PF-SOCKET-VERO13-18
 Bender Wirth: 438 Typ L1

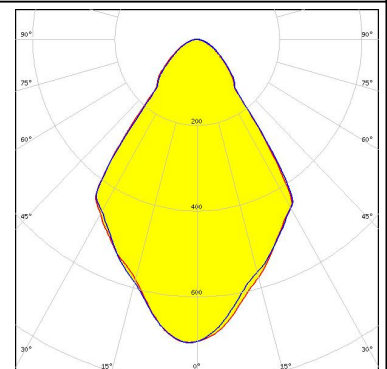
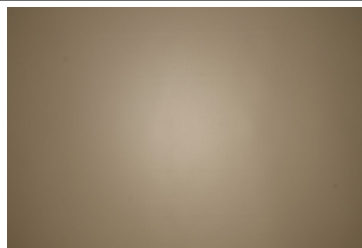

LED LUXEON CoB 1202s
 FWHM 75.0°
 Efficiency 92 %
 Peak intensity 0.700 cd/lm
 Required components:
 C13761_PF-SOCKET-CXA15

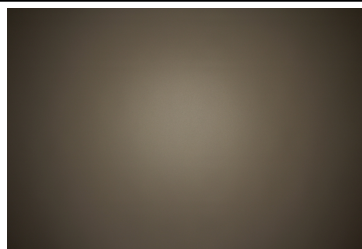

PHOTOMETRIC DATA (MEASURED):



LED COB J-Type
 FWHM 72.0°
 Efficiency 93 %
 Peak intensity 0.660 cd/lm
 Required components:
 C14037_PF-NSX-SOCKET

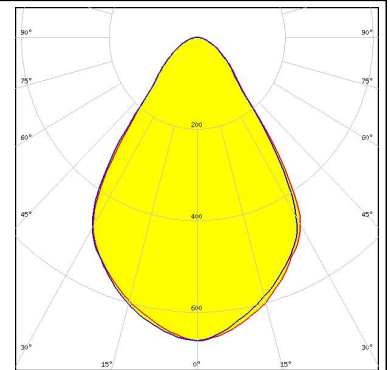
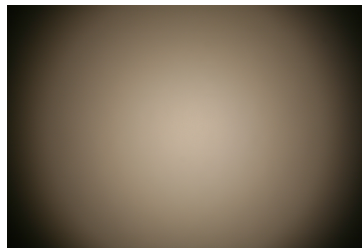

LED COB J-Type
 FWHM 70.0°
 Efficiency 89 %
 Peak intensity 0.670 cd/lm
 Required components:
 C13709_PF-SOCKET-VERO13-18
 Bender Wirth: 463 Typ L2

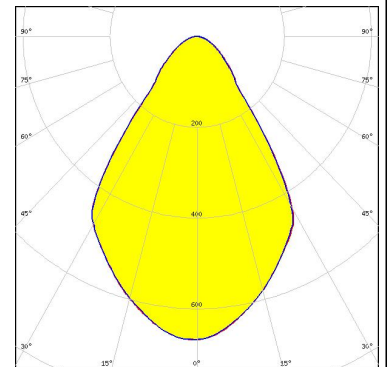

LED COB L-Type (LES 11)
 FWHM 70.0°
 Efficiency 90 %
 Peak intensity 0.680 cd/lm
 Required components:
 C13709_PF-SOCKET-VERO13-18
 Bender Wirth: 438 Typ L1

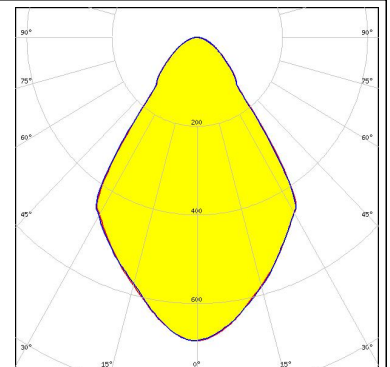

LED COB L-Type (LES 11)
 FWHM 72.0°
 Efficiency 93 %
 Peak intensity 0.680 cd/lm
 Required components:
 C14037_PF-NSX-SOCKET

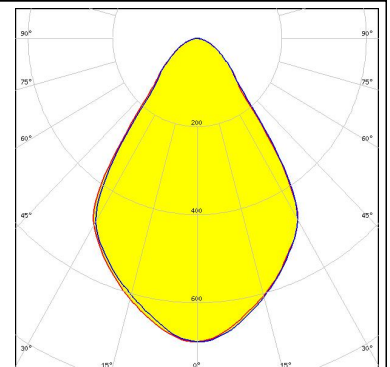
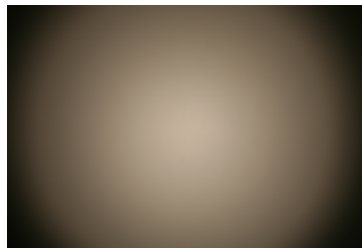

PHOTOMETRIC DATA (MEASURED):



LED COB L-Type (LES 9)
FWHM 72.0°
Efficiency 93 %
Peak intensity 0.720 cd/lm
Required components:
C14037_PF-NSX-SOCKET

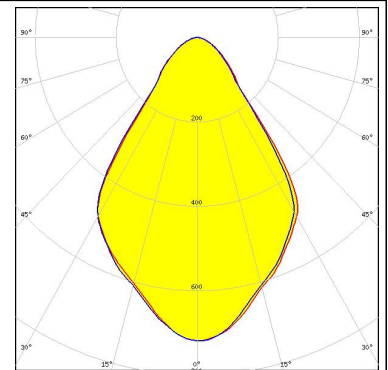
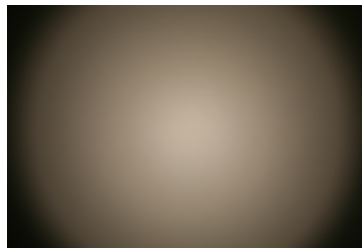

LED COB L-Type (LES 9)
FWHM 70.0°
Efficiency 90 %
Peak intensity 0.710 cd/lm
Required components:
C13709_PF-SOCKET-VERO13-18
Bender Wirth: 438 Typ L1

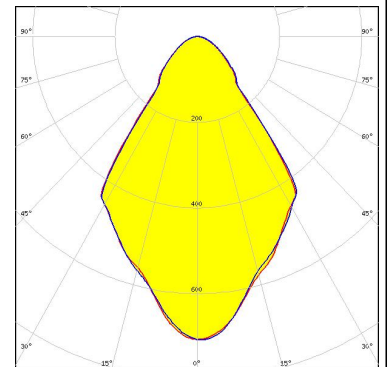
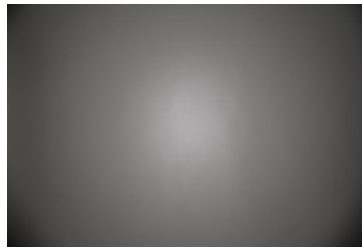

LED NSCxL036A
FWHM 71.0°
Efficiency 91 %
Peak intensity 0.690 cd/lm
Required components:
C14037_PF-NSX-SOCKET

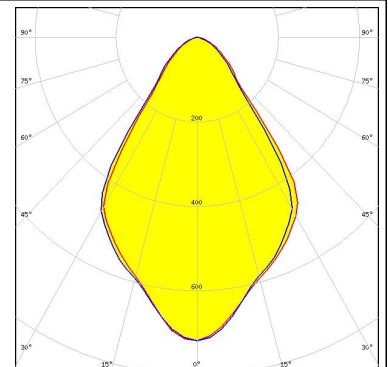
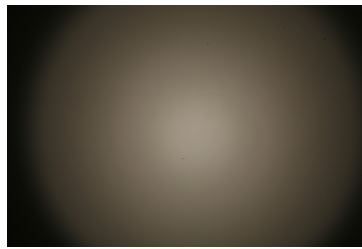

LED OSTAR Stage (S2WP)
FWHM 74.0°
Efficiency 83 %
Peak intensity 0.630 cd/lm
Required components:
C13083_PF-SOCKET
C14658_BARBARA-RZ-LENS

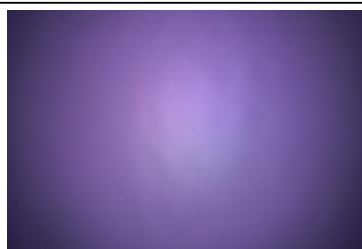

PHOTOMETRIC DATA (MEASURED):

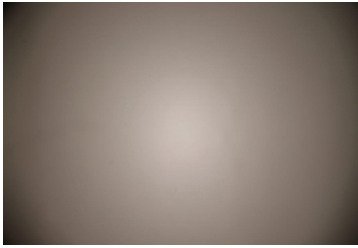
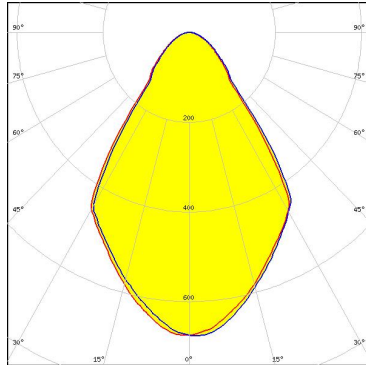
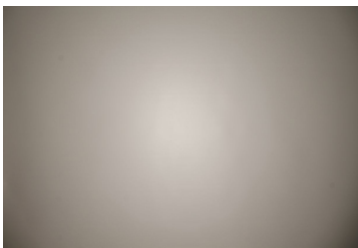
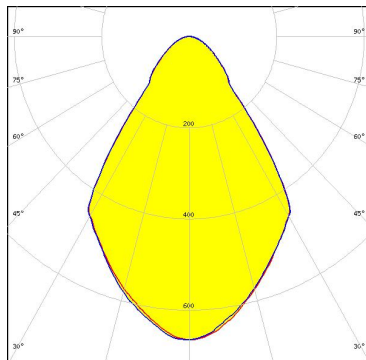
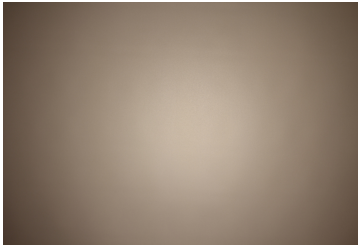
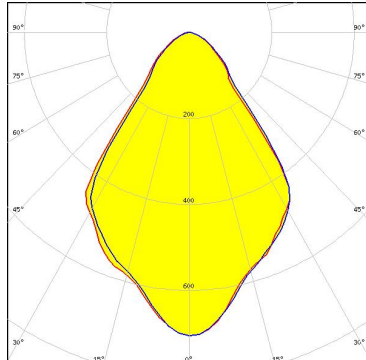
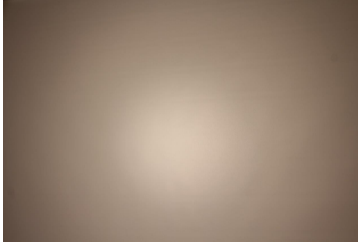
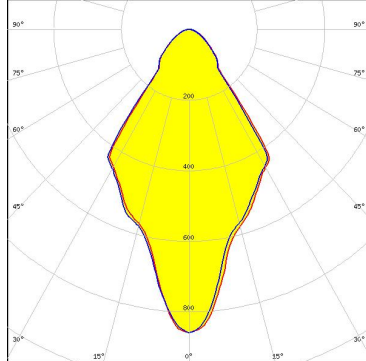
<p>OSRAM Opto Semiconductors</p> <p>LED Soleriq P13 FWHM 69.0° Efficiency 89 % Peak intensity 0.680 cd/lm Required components: C14115_PF-SOCKET-CXA15-18</p>		
<p>OSRAM Opto Semiconductors</p> <p>LED Soleriq P13 FWHM 70.0° Efficiency 89 % Peak intensity 0.670 cd/lm Required components: C13709_PF-SOCKET-VERO13-18 Bender Wirth: 437 Typ L1</p>		
<p>OSRAM Opto Semiconductors</p> <p>LED Soleriq P6 FWHM 73.0° Efficiency 92 % Peak intensity 0.700 cd/lm Required components: C13761_PF-SOCKET-CXA15</p>		
<p>OSRAM Opto Semiconductors</p> <p>LED Soleriq P6 FWHM 67.0° Efficiency 86 % Peak intensity 0.860 cd/lm Required components: C13709_PF-SOCKET-VERO13-18 Bender Wirth: 446 Typ L1</p>		

PHOTOMETRIC DATA (MEASURED):

OSRAM
Opto Semiconductors

LED Soleriq P9
FWHM 73.0°
Efficiency 92 %
Peak intensity 0.680 cd/lm
Required components:
C13761_PF-SOCKET-CXA15

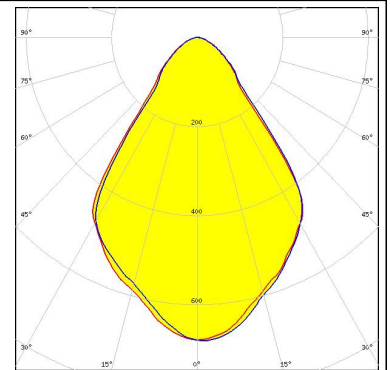

OSRAM
Opto Semiconductors

LED Soleriq P9
FWHM 71.0°
Efficiency 90 %
Peak intensity 0.710 cd/lm
Required components:
C13709_PF-SOCKET-VERO13-18
Bender Wirth: 461 Typ L1

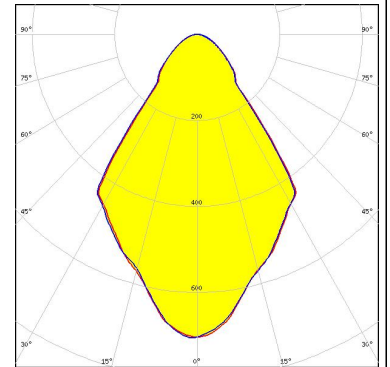
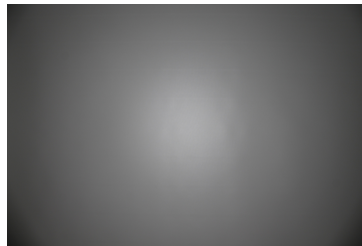

OSRAM
Opto Semiconductors

LED Soleriq S13
FWHM 70.0°
Efficiency 90 %
Peak intensity 0.690 cd/lm
Required components:
C13709_PF-SOCKET-VERO13-18
Bender Wirth: 437 Typ L1

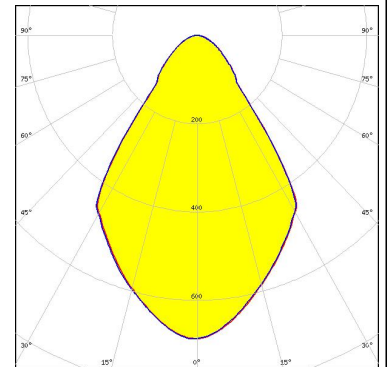
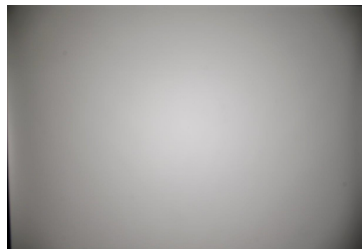

SAMSUNG

LED LC026B / 033B / 040B
FWHM 70.0°
Efficiency 90 %
Peak intensity 0.560 cd/lm
Required components:
C13709_PF-SOCKET-VERO13-18
Bender Wirth: 450 Typ L2

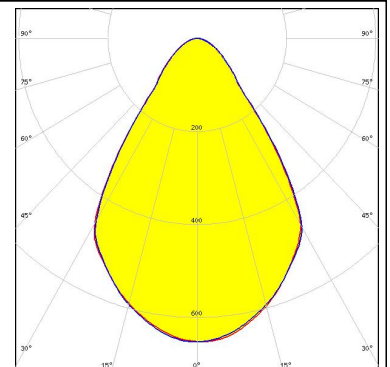
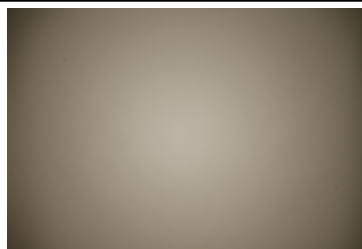

PHOTOMETRIC DATA (MEASURED):

TRIDONIC

LED SLE G5 LES11
FWHM 70.0°
Efficiency 90 %
Peak intensity 0.700 cd/lm
Required components:
C13709_PF-SOCKET-VERO13-18
Bender Wirth: 434 Typ L1

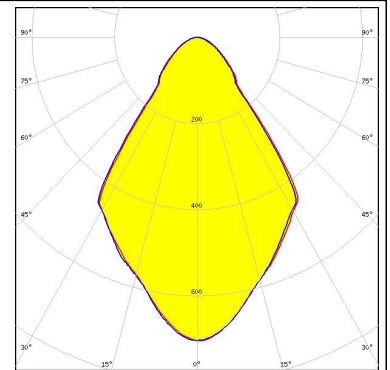
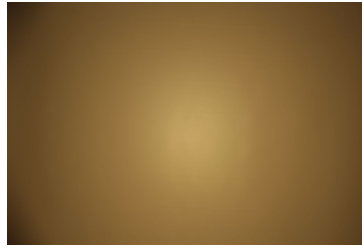

XICATO

LED XTM - 19mm LES
FWHM 70.0°
Efficiency 83 %
Peak intensity 0.600 cd/lm
Required components:
C14636_XTM-PF-ADAPTER

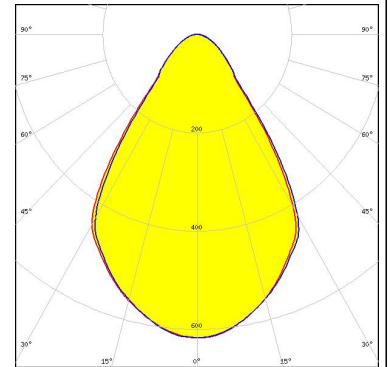
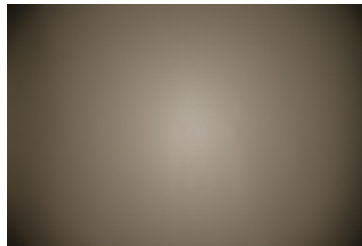

XICATO

LED XTM - 9mm LES
FWHM 70.0°
Efficiency 86 %
Peak intensity 0.700 cd/lm
Required components:
C14636_XTM-PF-ADAPTER

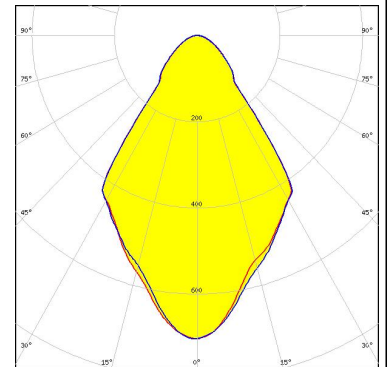
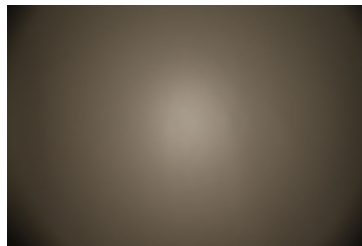

PHOTOMETRIC DATA (SIMULATED):



LED V10 Gen7
FWHM 66.0°
Efficiency 88 %
Peak intensity 0.900 cd/lm

Required components:

C13709_PF-SOCKET-VERO13-18
Bender Wirth: 434 Typ L1

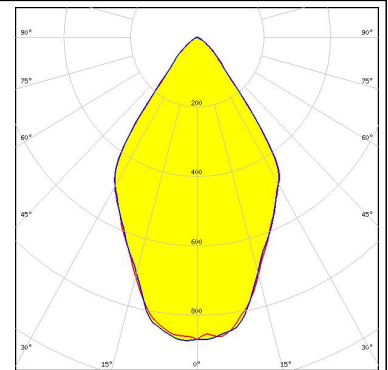

LED LUXEON CoB Compact
FWHM 75.0°
Efficiency 92 %
Peak intensity 0.700 cd/lm

Required components:

C13761_PF-SOCKET-CXA15



LED CXM-14
FWHM 70.0°
Efficiency 90 %
Peak intensity 0.700 cd/lm

Required components:

C13709_PF-SOCKET-VERO13-18
Bender Wirth: 433 Typ L1



LED CXM-9
FWHM 70.0°
Efficiency 90 %
Peak intensity 0.720 cd/lm

Required components:

C13709_PF-SOCKET-VERO13-18
Bender Wirth: 434 Typ L1

PHOTOMETRIC DATA (SIMULATED):

OSRAM
Opto Semiconductors

LED Soleriq S15

FWHM 74.0°

Efficiency 95 %

Peak intensity 0.680 cd/lm

Required components:

C13709_PF-SOCKET-VERO13-18

Bender Wirth: 433 Typ L1

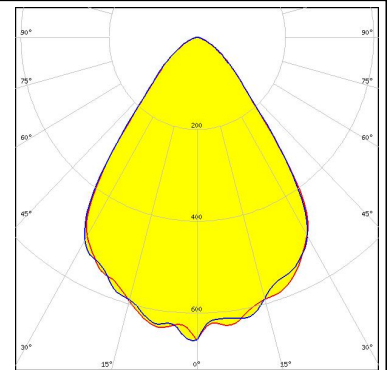

SAMSUNG

LED LC010C

FWHM 66.0°

Efficiency 89 %

Peak intensity 0.910 cd/lm

Required components:

C13709_PF-SOCKET-VERO13-18

Bender Wirth: 479 Typ L1

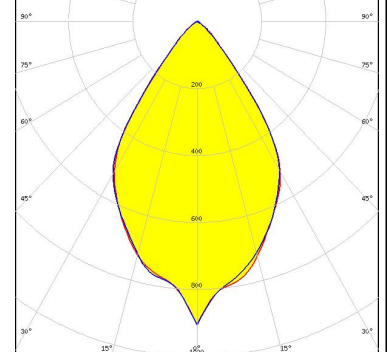

SAMSUNG

LED LC020C

FWHM 70.0°

Efficiency 88 %

Peak intensity 0.810 cd/lm

Required components:

C13709_PF-SOCKET-VERO13-18

Bender Wirth: 479 Typ L1

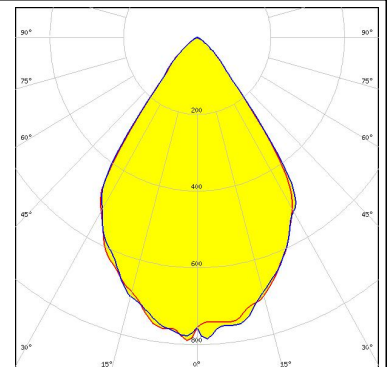

SAMSUNG

LED LC040C

FWHM 70.0°

Efficiency 84 %

Peak intensity 0.730 cd/lm

Required components:

C13709_PF-SOCKET-VERO13-18

Bender Wirth: 480 Typ L1

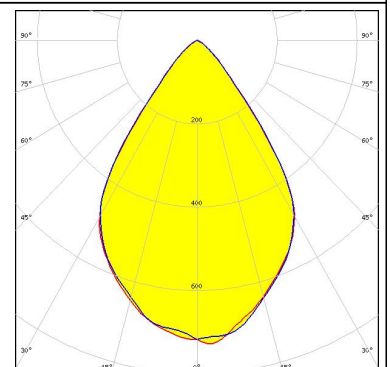

PHOTOMETRIC DATA (SIMULATED):

 SEOUL SEMICONDUCTOR	
LED	ZC12/18
FWHM	70.0°
Efficiency	90 %
Peak intensity	0.680 cd/lm
Required components:	
C13709_PF-SOCKET-VERO13-18	
Bender Wirth: 433 Typ L1	
<hr/>	
 SEOUL SEMICONDUCTOR	
LED	ZC4/6
FWHM	70.0°
Efficiency	90 %
Peak intensity	0.720 cd/lm
Required components:	
C13709_PF-SOCKET-VERO13-18	
Bender Wirth: 434 Typ L1	

GENERAL INFORMATION:

NOTE: The typical beam angle will be changed by different color, chip size and chip position tolerance. The typical total beam angle is the full angle measured where the luminous intensity is half of the peak value.

Due to use of high power COB's with this product, special attention to proper thermal design is highly recommended. LEDiL has no liability for direct, indirect or consecutive damages arising from the LEDiL products being used outside of the recommended temperature range.

MATERIALS:

As part of our continuous research and improvement processes, and to ensure the best possible quality and availability of our products, LEDiL reserves the right to change material grades without notice.

PRODUCT DATA USER AGREEMENT AND DISCLAIMER:

The measured data in the provided downloadable LEDiL Product Datasheets and Mechanical 2D-Drawings is rounded and provided as reference for planning. LEDiL Oy's optical specifications have been verified by conducting performance testing of the products in accordance with the company's quality system. The reported data are averaged results of multiple measurements with typical variation. LEDiL Oy reserves the right to without prior notification make changes and improvements to its products.

LEDiL Oy assumes neither warranty, nor guarantee nor any other liability of any kind for the contents and correctness of the provided data. The provided data has been generated with highest diligence but the provided data may in reality not represent the complete possible variation range of all intrinsic parameters. Therefore, in certain cases a deviation from the provided data could occur.

LEDiL Oy reserves the right to undertake technical changes of its products without further notification which could lead to changes in the provided data. LEDiL Oy assumes no liability of any kind for the possible deviation from any provided data or any other damage resulting from the usage of the provided data.

The user agrees to this disclaimer and user agreement with the download or usage of the provided files.

LEDiL Oy

Joensuunkatu 13
FI-24240 SALO
Finland

LEDiL Inc.

228 West Page Street
Suite D
Sycamore IL 60178
USA

Local sales and technical support

www.ledil.com/where_to_buy

Shipping locations

Salo, Finland
Hong Kong, China

Distribution Partners

www.ledil.com/where_to_buy