

# NEW PRODUCTS\*

## MICRO-SCALE TEST KIT

Micro-scale Test Kit accessories are designed to attach to industry standard multimeter test probes or prods. These accessories allow convenient and safe testing on breadboards or printed circuit boards.

### KT-MS002 includes:

- (2) 48" test leads with right angle shrouded banana plug to test prod
- (2) Alligator Clip Micro-scale test lead attachments (one red, one black)
- (2) Micro-plunger Clip Micro-scale test lead attachments (one red, one black)
- (2) Breadboard Pin Micro-scale test lead attachments (one red, one black)
- (2) Needle Pin Micro-scale test lead attachments (one red, one black)
- (2) Pin Socket Micro-scale test lead attachments (one red, one black)
- (2) Magnetic Probe Micro-scale test lead attachments (one red, one black)
- (1) Battery Current Probe Micro-scale test lead attachment
- (2) Nano-plunger Clip Micro-scale test lead attachments (one red, one black)
- (1) Carrying pouch

### KT-MS001 INCLUDES:

- All of the above accessories without the 48" test leads



### ALLIGATOR CLIP ATTACHMENT

- Used to grip larger terminals, rails and wires
- Mueller BU-30 Clip
- Insulator included to reduce the risk of shorting to other components
- Rated for 5 amps of current



### MAGNETIC PROBE ATTACHMENT

- Used to attach to any metal surface
- Can be used to hold one lead to a cabinet ground, freeing both hands to probe other components.
- Effortless connection to a dry-cell battery



### BREADBOARD PIN ATTACHMENT

- Used for hands free probing of breadboards
- Fits standard .025 inch square holes
- 50 micron gold plated pin ensures long life and accurate measurements
- Insulated handle for effortless insertion



### NANO-PLUNGER CLIP ATTACHMENT

- Used to grip fine-pitch leads on circuit boards
- Ideal for SMD pins with pitches as low as 1mm
- Gold plated for low resistance connections



### BATTERY CURRENT PROBE ATTACHMENT

- Used to measure the current in a dry cell battery compartment
- Easily inserts between the battery and the spring contact



### NEEDLE PIN ATTACHMENT

- Used to pierce the conformal coating on circuit boards
- Has low profile holder to reach tight locations



### PIN SOCKET ATTACHMENT

- Used to connect to .080" male pins
- A great way to test D-Sub connectors
- High quality gold plated contact



### MICRO-PLUNGER CLIP ATTACHMENT

- Used to grip the leads on through-hole components
- Small enough to test individual IC leads
- Durable nylon construction

### CARRYING POUCH

- Used to store and carry all of the Micro-scale Accessories
- Fits comfortably in a shirt or pants pocket



Mueller clips are the industry standard. Our designs reflect 95 years of innovation and improvement. Mueller clips assure teeth that bite, springs that hold, plating that lasts and insulators that protect.

#### Color Key

0=Black	4=Yellow	6=Blue
2=Red	5=Green	9=White

### Miniature Alligator

#### Model # BU-30/BU-30C

Solder or crimp connection  
Jaw opens 0.188" (4.8 mm) max

**Material:** nickel-plated steel (BU-30) or solid copper (BU-30C)

**Length:** 1.1" (27.78mm)

**Federal Spec:** CID AA59466-001 (BU-30C)

**Rating:** 5 Amps

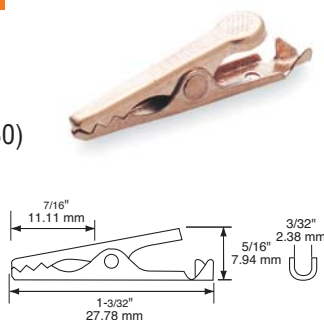

### Miniature Alligator with Barrel

#### Model # BU-30BL

Solder or crimp connection  
Jaw opens 0.188" (4.8 mm) max

**Material:** nickel-plated steel

**Length:** 1.25" (31.75mm)

**Rating:** 5 Amps

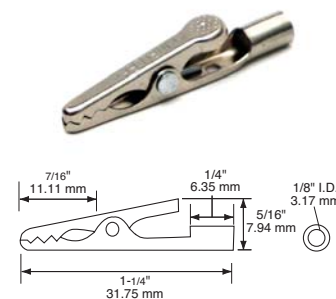

### Insulator for Miniature Alligator

#### Model # BU-32-\*

Protective flexible vinyl insulator for 30, 30C

**Material:** PVC

**Length:** 1.63" (41.28mm)

**\*Std. Colors:** -0 Black, -2 Red, -4 Yellow, -5 Green, -6 Blue, -9 White

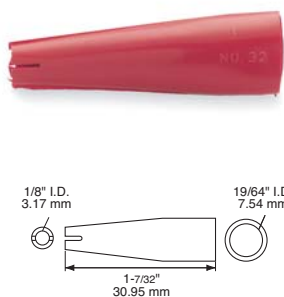

### Miniature Alligator with Threaded Barrel

#### Model # BU-30TBO

6-32 threaded steel barrel connection  
Jaw opens 0.188" (4.8 mm) max

**Material:** nickel-plated steel

**Length:** 1.5" (38.75mm)

**Rating:** 5 Amps



## Insulator for Mini Alligator Barrel/Threaded Barrel

### Model # BU-31-\*

Protective flexible vinyl insulator for 30BL, 30TBO

**Material:** PVC

**Length:** 1.63" (41.28mm)

**\*Std. Colors:** -0 Black, -2 Red, -4 Yellow, -5 Green, -6 Blue, -9 White

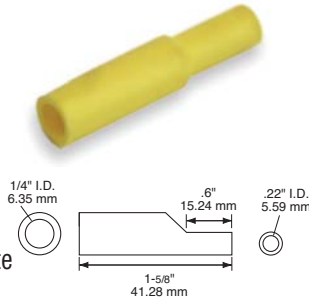

## Micro-Alligator

### Model # BU-34/BU-34C

Solder or crimp connection

Jaw opens 0.22" (5.6 mm) max

**Material:** nickel-plated steel (BU-34) or solid copper (BU-34C)

**Length:** 1.09" (27.78mm)

**Rating:** 5 Amps

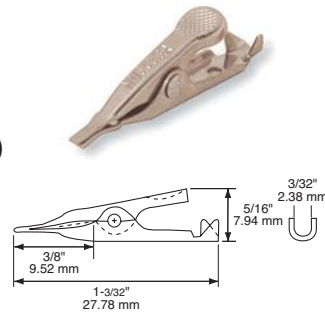

## Insulator for Micro Alligator

### Model # BU-36-\*

Protective flexible vinyl insulator for 34, 34C

**Material:** PVC

**Length:** 1.22" (30.95mm)

**\*Std. Colors:** -0 Black, -2 Red, -4 Yellow, -5 Green, -6 Blue, -9 White



## Alligator Clip with Barrel

### Model # BU-60/BU-60C/BU-60X

Compatible with all shrouded, unshrouded, or retractable 0.16" (4mm) banana plugs

Solder or crimp connection

Jaw opens 0.31" (7.9 mm) max

**Material:** nickel-plated steel (BU-60), solid copper (BU-60C), solid stainless steel (BU-60X)

**Length:** 1.97" (50mm)

**Rating:** 10 Amps

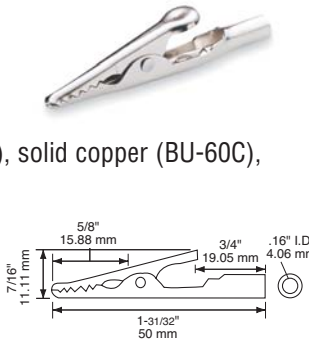

## Alligator Clip with Screw

### Model # BU-60S/BU-60CS

Compatible with all shrouded, unshrouded, or retractable 0.16" (4mm) banana plugs

6-40 screw connection

Jaw opens 0.31" (7.9 mm) max

**Material:** nickel-plated steel (BU-60S) or solid copper (BU-60CS)

**Length:** 1.97" (50mm)

**Federal Spec:** CID AA59466-002 (BU-60CS)

**Rating:** 10 Amps

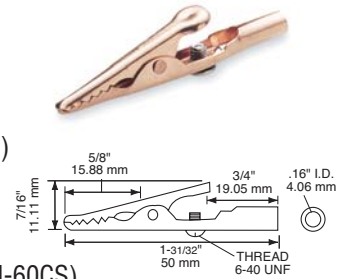

## Phone Tip Alligator Clip

### Model # BU-60PR2

Accepts standard phone tip or test prod tip

Jaw opens 0.31" (7.9 mm) max

**Material:** nickel-plated steel

**Length:** 1.97" (50mm)

**Rating:** 10 Amps

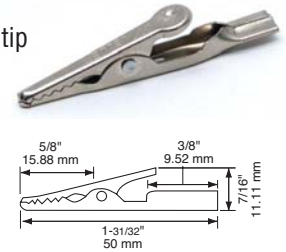

## Threaded Barrel Alligator Clip

### Model # BU-60TBO

8-32 threaded barrel connection

Jaw opens 0.31" (7.9 mm) max

**Material:** nickel-plated steel

**Length:** 2.13" (53.97mm)

**Rating:** 10 Amps



## Alligator Clip

### Model # BU-60U

Solder or crimp connection

Jaw opens 0.31" (7.9 mm) max

**Material:** nickel-plated steel

**Length:** 1.97" (50mm)

**Rating:** 10 Amps

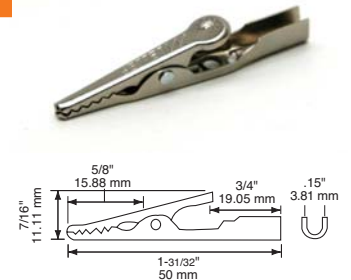

## Alligator Clip with Cage Spring Barrel

### Model # BU-61

Cage spring connection accepts standard prod needle (0.080 dia.)

Jaw opens 0.31" (7.9 mm) max

**Material:** nickel-plated steel clip, nickel-plated brass insert, gold plated beryllium copper cage spring

**Length:** 2.03" (51.59mm)

**Rating:** 10 Amps

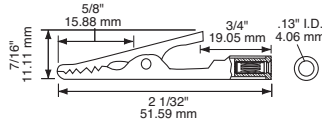

## Insulator for Alligator Clips

### Model # BU-62-\*

Protective flexible vinyl insulator for 60, 60C, 60CS, 60PR2, 60S, 60TBO, 60U, 60X and 61

**Material:** PVC

**Length:** 2.03" (51.59mm)

**\*Std. Colors:** -0 Black, -2 Red, -4 Yellow, -5 Green, -6 Blue, -9 White

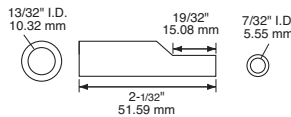

## Alligator Clip with Acetate Handle

### Model # BU-60H-\*

Compatible with all shrouded, unshrouded, or retractable 0.16" (4mm) banana plugs

Jaw opens 0.31" (7.9 mm) max

**Material:** nickel-plated steel clip; tenite acetate insulated handle

**Length:** 2.23" (56.75mm)

**\*Std. Colors:** -0 Black, -2 Red, -4 Yellow, -5 Green, -6 Blue, -9 White

**Rating:** 10 Amps

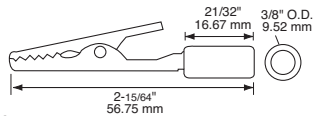

## Alligator Clip with Acetate Handle and Screw

### Model # BU-60HS-\*/BU-60CHS-\*

Compatible with all shrouded, unshrouded, or retractable 0.16" (4mm) banana plugs

Jaw opens 0.31" (7.9 mm) max

**Material:** nickel-plated steel (BU-60HS-\*) or solid copper (BU-60CHS-\*) clip; tenite acetate insulated handle

**Length:** 2.34" (59.53mm)

**\*Std. Colors:** -0 Black, -2 Red, -4 Yellow, -5 Green, -6 Blue, -9 White

**Federal Spec:** AA59466-003 (red), AA59466-016 (black), (BU-60CHS-\*)

**Rating:** 10 Amps

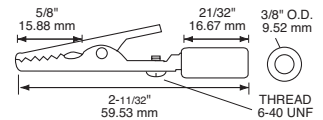

## Phone Tip Alligator Clip with Acetate Handle

### Model # BU-60HPR-\*

Accepts standard phone tip or test prod tip

**Material:** nickel-plated steel clip; tenite acetate insulated handle

**Length:** 2.23" (56.75mm)

**\*Std. Colors:** -0 Black, -2 Red, -4 Yellow, -5 Green, -6 Blue, -9 White

**Rating:** 10 Amps

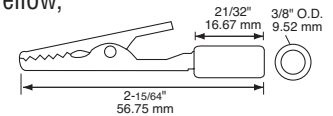

## Insulated Alligator Clip

### Model # BU-63-\*/BU-63C-\*

BU-63-\* same as BU-60S and includes a skin-tight, two-piece, flexible insulator

BU-63C-\* same as BU-60CS and includes a skin-tight, two piece, flexible insulator

Compatible with all shrouded, unshrouded, or retractable 0.16" (4mm) banana plugs

**Material:** nickel-plated steel (BU-63-\*) or solid copper (BU-63C-\*); PVC insulator

**Length:** 2.25" (57.15mm)

**\*Std. Colors:** -0 Black, -2 Red, -4 Yellow, -5 Green, -6 Blue, -9 White

**Rating:** 10 Amps

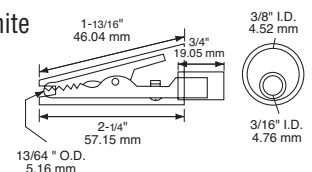

## Alligator Clip

### Model # BU-70/BU-70C

Solder or crimp connection  
Jaw opens 0.313" (7.9 mm) max

**Material:** nickel-plated steel (BU-70) or solid copper (BU-70C)

**Length:** 1.69" (42.86mm)

**Rating:** 5 Amps (BU-70) or 10 Amps (BU-70C)

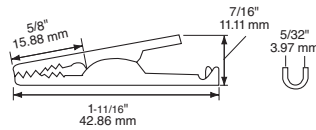

## Alligator Clip with Screw

### Model # BU-70S/BU-70CS

6-40 screw or crimp connection  
Jaw opens 0.313" (7.9 mm) max

**Material:** nickel-plated steel (BU-70S) or solid copper (BU-70CS)

**Length:** 1.69" (42.86mm)

**Federal Spec:** AA59466-0017 (BU-70CS-\*)

**Rating:** 5 Amps (BU-70S) or 10 Amps (BU-70CS)

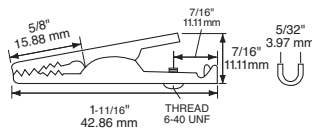

## Insulator for Alligator Clip

### Model # BU-72-\*

Protective flexible vinyl insulator for 70, 70C, 70CS, 70S

**Material:** PVC

**Length:** 1.81" (46.04mm)

**\*Std. Colors:** -0 Black, -2 Red, -4 Yellow, -5 Green, -6 Blue, -9 White

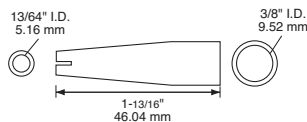

## Crocodile Clip

### Model # BU-85/BU-85C

Crimp or screw connection  
Jaw opens 0.313" (7.9 mm) max  
Nesting teeth provide solid contact along entire length of jaw

**Material:** zinc-plated steel (BU-85) or solid copper (BU-85C)

**Length:** 2.125" (53.97mm)

**Federal Spec:** AA59466-005 (BU-85C)

**Rating:** 5 Amps (BU-85) or 10 Amps (BU-85C)

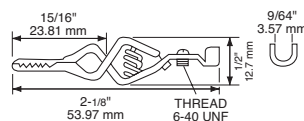

## Insulator for Crocodile Clip

### Model # BU-87-\*

Protective flexible vinyl insulator for 85, 85C

**Material:** PVC

**Length:** 1.7" (43.26mm)

**\*Std. Colors:** -0 Black, -2 Red, -4 Yellow, -5 Green, -6 Blue, -9 White

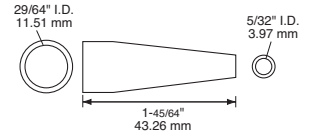

## Small Safety Alligator Clip

### Model # BU-651-\*

Compatible with all shrouded, unshrouded, or retractable 0.16" (4mm) banana plugs

Jaw opens 0.27" (7 mm) max

**Material:** nickel-plated steel clip, glass-filled nylon housing

**Length:** 2.24" (57mm)

**\*Std. Colors:** -0 Black, -2 Red

**Rating:** 1000 V category II, 600V category III, 20 Amps, IEC 1010 Compliant



## Small Safety Alligator Clip with Extended Banana Jack

### Model # BU-652-\*

Compatible with all shrouded, unshrouded, or retractable 0.16" (4mm) banana plugs

Jaw opens 0.27" (7 mm) max

**Material:** nickel-plated steel clip, glass-filled nylon housing

**Length:** 3.24" (82mm)

**\*Std. Colors:** -0 Black, -2 Red

**Rating:** 1000 V category II, 600V category III, 20 Amps, IEC 1010 Compliant



## Large Safety Alligator Clip

### Model # BU-65-\*

Compatible with all shrouded, unshrouded, or retractable 0.16" (4mm) banana plugs

Jaw opens 0.75" (19 mm) max

**Material:** nickel-plated steel clip, glass-filled nylon housing

**Length:** 3.23" (82.04mm)

**\*Std. Colors:** -0 Black, -2 Red, -4 Yellow, -6 Blue

**Rating:** 1000 V, 30 Amps, IEC 1010 Compliant



## Large Flanged Safety Alligator Clip

### Model # BU-654-\*

Compatible with all shrouded, unshrouded, or retractable 0.16" (4mm) banana plugs

Jaw opens 1.00" (26 mm) max

**Material:** nickel-plated steel clip, glass-filled nylon housing

**Length:** 3.19" (81mm)

\***Std. Colors:** -0 Black, -2 Red

**Rating:** 1000 V category II, 600V category III, 20 Amps, IEC 1010 Compliant



## Pee-Wee Clip

### Model # BU-45/BU-45C

Screw or crimp connection

Jaw opens 0.31" (7.9 mm) max

**Material:** zinc-plated steel (BU-45) or solid copper (BU-45C)

**Length:** 1.53" (38.89mm)

**Federal Spec:** CID AA59466-006 (BU-45C)

**Rating:** 5 Amps (BU-45) or 10 Amps (BU-45C)

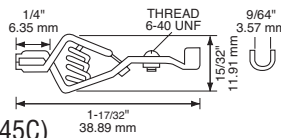

## Insulator for Pee-Wee Clip

### Model # BU-47-\*

Protective flexible vinyl insulator for 45, 45C

**Material:** PVC

**Length:** 2.02" (51.2 mm)

\***Std. Colors:** -0 Black, -2 Red, -4 Yellow, -5 Green, -6 Blue, -9 White

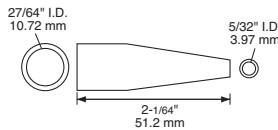

## Economy Clip

### Model # BU-55

Screw or crimp connection

Jaw opens 0.44" (11.1 mm) max

**Material:** zinc-plated steel

**Length:** 2" (50.8mm)

**Rating:** 10 Amps

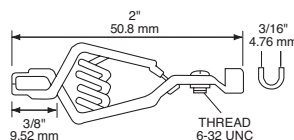

## Insulator

### Model # BU-74-\*

Protective flexible vinyl insulator for 55

Accepts 0.27" (7 mm) ignition wire

**Material:** PVC

**Length:** 2.875" (73mm)

\***Std. Colors:** -0 Black, -2 Red, -4 Yellow, -5 Green, -6 Blue, -9 White

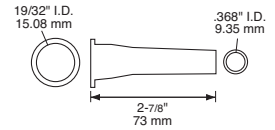

## Automotive Analyzer Clip

### Model # BU-48B/BU-48C

Screw or crimp connection

Jaw opens 0.5" (12.7 mm) max

Teeth mesh on three sides of the jaw

**Material:** zinc-plated steel (BU-48B) or solid copper (BU-48C)

**Length:** 2" (50.8mm)

**Federal Spec:** CID AA59466-007 (BU-48C)

**Rating:** 10 Amps (BU-48B) or 20 Amps (BU-48C)

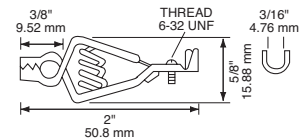

## Automotive Analyzer Clip

### Model # BU-48B2E

Screw or double crimp connection

Jaw opens 0.5" (12.7 mm) max

**Material:** zinc-plated steel

**Length:** 2" (50.8mm)

**Rating:** 10 Amps

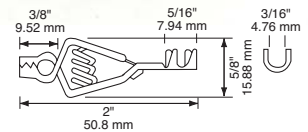

## Meter Testing Clip With Needle

### Model # BU-50C

Solid copper clip with beryllium copper piercing needle in the top jaw

Jaw opens 0.5" (12.7 mm) max

**Material:** Solid copper

**Length:** 2.28" (57.12mm)

**Federal Spec:** CID AA59466-013

**Rating:** 20 Amps

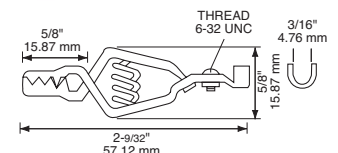

## Meter Testing Clip

### Model # BU-51C

Same as BU-50C except without insulation piercing needle

Jaw opens 0.5" (12.7 mm) max

**Material:** Solid copper

**Length:** 2.28" (57.12mm)

**Rating:** 20 Amps

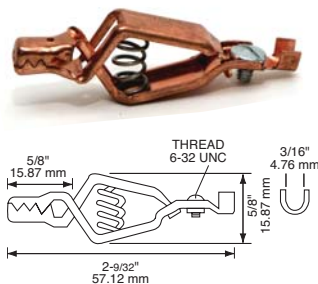

## Insulator for Automotive Analyzer Clip

### Model # BU-49-\*

Protective flexible vinyl insulator for 48B, 48B2E, 48C, 50C, 51C, 55, 95

**Material:** PVC

**Length:** 2.56" (65.09mm)

\*Std. Colors: -0 Black, -2 Red, -4 Yellow, -5 Green, -6 Blue, -9 White

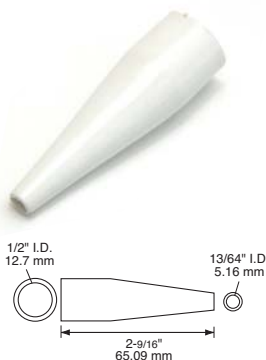

## General Purpose Clip

### Model # BU-27/BU-27C

Crimp or screw connection; jaw opens 0.625" (16 mm) max

**Material:** zinc-plated steel (BU-27) or solid copper (BU-27C); *Spring:* steel

**Length:** 2.44" (61.9mm)

**Federal Spec:** CID AA59466-008 (BU-27C)

**Rating:** 20 Amps (BU-27) or 40 Amps (BU-27C)

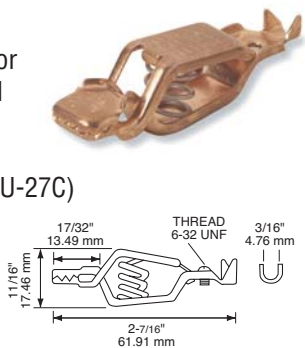

## Geophone Clip

### Model # BU-27CG/BU-27CGW

Crimp or screw connection; jaw opens 0.625" (16 mm) max; curved jaws clip on to seismograph rings

**Material:** solid copper; *Spring:* steel

**Length:** 2.4" (61.1mm)

**Rating:** 40 Amps

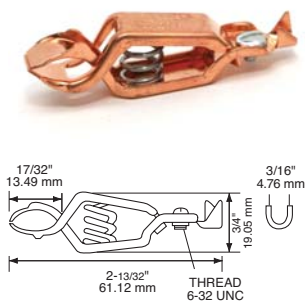

## General Purpose/Geophone Clips

### Model # BU-29-\*

Protective flexible vinyl insulator for 27, 27C, 27CG, 27CGW

**Material:** PVC

**Length:** 3.5" (88.9mm)

\*Std. Colors: -0 Black, -2 Red, -4 Yellow, -5 Green, -6 Blue, -9 White



## Insulator for General Purpose/Geophone Clips

### Model # BU-90-\*

Protective flexible vinyl insulator for 27, 27C, 27CG and 27CGW

Accepts larger wires or cables than BU-29-\*

**Material:** PVC

**Length:** 3.375" (92mm)

\*Std. Colors: -0 Black, -2 Red, -4 Yellow, -5 Green, -6 Blue, -9 White

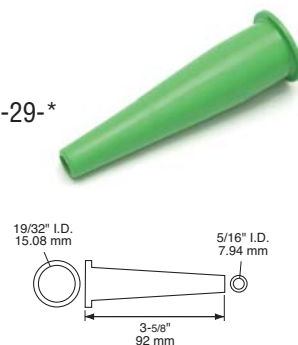

## Heavy Duty Clip

### Model # BU-24APN/BU-24APS

Crimp or screw connection; jaw opens 0.75" (19 mm) max; clip unmarked (BU-24APN) and marked positive (BU-24APS)

**Material:** zinc-plated steel; *Spring:* steel

**Length:** 2.84" (72.23mm)

**Rating:** 25 Amps

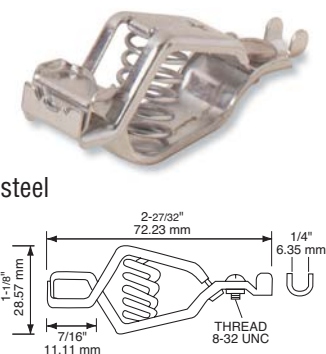

## Automotive Clip

### Model # BU-25/BU-25C

Crimp or screw connection; jaw opens 0.75" (19 mm) max; teeth mesh on three sides of the jaw

**Material:** zinc-plated steel (BU-25) or solid copper (BU-25C); *Spring:* steel

**Length:** 3" (72.6mm)

**Federal Spec:** CID AA59466-009 (BU-25C)

**Rating:** 40 Amps (BU-25) or 75 Amps (BU-25C)

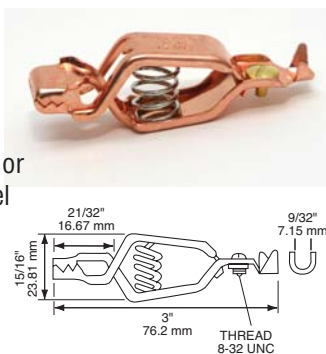

## Insulator for Automotive Clip

### Model # BU-26-\*

Protective flexible vinyl insulator for 24A, 25, 25C

**Material:** PVC

**Length:** 3.88" (98.4 mm)

**\*Std. Colors:** -0 Black, -2 Red, -4 Yellow, -5 Green, -6 Blue, -9 White

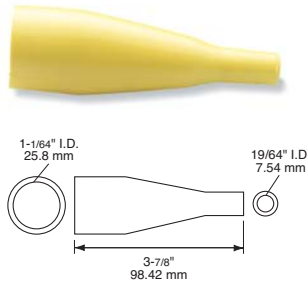

## Heavy Duty Clip for Battery and Test Work

### Model # BU-21APN/BU-21APS/BU-21CPN/BU-21CPS

Crimp or screw connection; copper version (21C) equipped with removable copper lug; jaw opens 1.06" (27 mm) max; clip unmarked (BU-21APN/CPN) and marked positive (BU-21APS/CPS)

**Material:** zinc-plated steel (21A) or solid copper (21C); *Spring:* steel

**Length:** 4.11" (104.4mm)

**Federal Spec:** CID AA59466-010 (BU-21CPN)

**Rating:** 50 Amps (21A) or 100 Amps (21C)

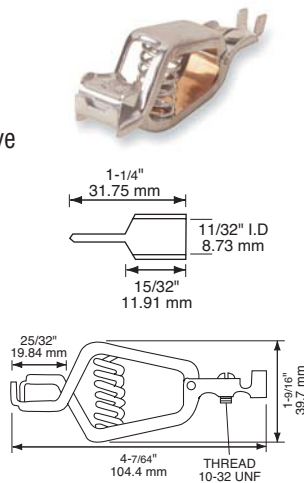

## Insulator for Heavy Duty Battery Test Clip

### Model # BU-23-\*

Protective flexible vinyl insulator for 21A, 21C

**Material:** PVC

**Length:** 5" (127mm)

**\*Std. Colors:** -0 Black, -2 Red, -4 Yellow, -5 Green, -6 Blue, -9 White



## Heavy Duty Clip for Grounding Applications

### Model # BU-11APN/BU-11APS/BU-11CPN/BU-11CPS

Copper version has a lug connection

Jaw opens 1.625" (41.3 mm) max

Clip unmarked (BU-11APN/CPN) and marked positive (BU-11APS/CPS)

**Material:** zinc-plated steel (11A) or solid copper (11C); *Spring:* steel

**Length:** 6" (152.4 mm)

**Federal Spec:** CID AA59466-011 (BU-11CPN)

**Rating:** 100 Amps (11A) or 200 Amps (11C)

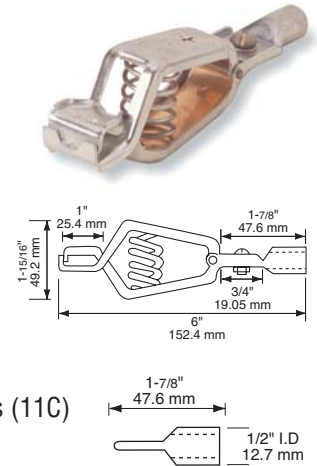

## Insulator for Heavy Duty Clip

### Model # BU-13-\*

Protective flexible vinyl insulator for 11A, 11C

**Material:** PVC

**Length:** 6.8" (173mm)

**\*Std. Colors:** -0 Black, -2 Red, -4 Yellow, -5 Green, -6 Blue, -9 White



## Welding Clip

### Model # BU-33C

Lug connection

Jaw opens 1.81" (46 mm) max

**Material:** solid copper

**Length:** 7.75" (196.8mm)

**Federal Spec:** CID AA59466-012

**Rating:** 300 Amps

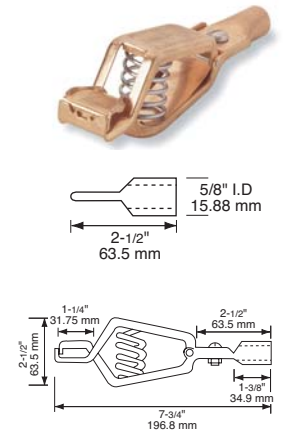

## Insulator for Welding Clip

### Model # BU-35-\*

Protective flexible vinyl insulator for 33C

**Material:** PVC

**Length:** 8.75" (222mm)

**\*Std. Colors:** -0 Black, -2 Red,





## Grounding Clamp

**Model # BU-58**

Attaches to pipe up to 1 3/8" outer diameter

**Material:** zinc-plated steel

**Length:** 2.31" (58.75mm)

**Rating:** 50 Amps



## Micro Plier-Type Clip

**Model # BU-40A-\*/BU-40C-\***

Solder or crimp connection

Jaw opens 0.75" (19 mm) max

**Material:** nickel-plated steel (BU-40A) or solid copper (BU-40C), PVC insulator (BU-42PR-\*)

**Length:** 2.3" (58mm)

**\*Std. Colors:** Insulator (BU-42PR-\*) -0 Black, -2 Red, -4 Yellow, -5 Green, -6 Blue, -9 White

**Rating:** 15 Amps (BU-40A), 20 Amps (BU-40C)



## Insulator for Micro Plier-Type Clip

**Model # BU-42PR-\***

Protective flexible vinyl insulator for BU-40

**Material:** PVC

**Length:** 1" (25.4mm)

**\*Std. Colors:** -0 Black, -2 Red, -4 Yellow, -5 Green, -6 Blue, -9 White



## Miniature Plier-Type Clip

**Model # BU-46A-\*/BU-46C-\***

Solder or crimp connection

Jaw opens 1.125" (28.6 mm) max

**Material:** copper-plated steel (BU-46A) or solid copper (BU-46C), PVC insulator (BU-46PR-\*)

**Length:** 2.88" (98.42mm)

**\*Std. Colors:** Insulator (BU-46PR-\*) in -0 Black, -2 Red

**Rating:** 50 Amps (46A) or 75 Amps (46C)

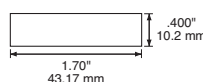
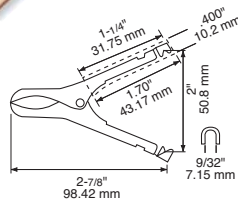

## Insulator for Miniature Plier-Type Clip

**Model # BU-46PR-\***

Protective flexible vinyl insulator for BU-46

**Material:** PVC

**Length:** 1.7" (43.18mm)

**\*Std. Colors:** -0 Black, -2 Red,



## Plier-Type Clip

**Model # BU-41A-\*/BU-41APN/BU-41C-\*/BU-41CPN**

Jaw opens 1.625" (41.3 mm) max

Locks on to both side and top mounted battery terminals

**Material:** copper-plated steel (BU-41A) or solid copper (BU-41C), PVC insulator (BU-43PR-\*)

**Length:** 6" (152mm)

**\*Std. Colors:** Insulator (BU-43PR-\*) in -0 Black, -2 Red, -4 Yellow, -5 Green, -6 Blue, -9 White

**Federal Spec:** CID AA59466-014 BU-41-CPS-VZZZ-2 (red) and CID AA59466-015, BU-41CPN-VZZZ-0 (black)

**Rating:** 200 Amps (41A) or 400 Amps (41C)

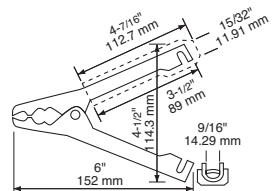
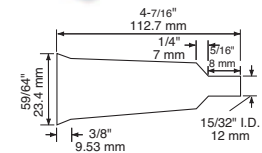

## Insulator for Plier-Type Clip

**Model # BU-43PR-\***

Protective flexible vinyl insulator for BU-41

**Material:** PVC

**Length:** 4.4" (112.73mm)

**\*Std. Colors:** -0 Black, -2 Red, -4 Yellow, -5 Green, -6 Blue, -9 White



## Insulated Battery Clip

**Model # BU-102B-\*/BU-102BK-\***

Fully insulated clip with serrated jaws; BU-102BK-\* has Kelvinized isolated jaws and no copper shunt

**Material:** *Housing:* glass filled nylon; *Jaw:* copper; *Spring:* music wire, zinc plated

**Length:** 6.5" (165mm)

**\*Std. Colors:** -0 Black, -2 Red

**Rating:** 300 Amps



### Insulated Welding Clip

**Model # BU-102W-\***

Fully insulated clip with serrated contact pad and braided copper shunt

**Material:** *Housing:* glass filled nylon;  
*Jaw:* copper; *Spring:* music wire, zinc plated

**Length:** 6.5" (165mm)

**\*Std. Colors:** -0 Black, -2 Red

**Rating:** 400 Amps



### Epoxy Coated Battery Clip

**Model # BU-X15400-\***

Jaw opens 1.50" (38.1 mm) max

Locks on to both side and top mounted battery terminals

**Material:** steel, epoxy coated clips with copper plated jaws

**Length:** 6.75" (171.45mm)

**\*Std. Colors:** -0 Black, -2 Red

**Rating:** 200 Amps



### Kelvin Clip

**Model # BU-75K**

Jaw opens 0.313" (7.9 mm) max

Isolated jaws

**Material:** Silver/Gold tip contacts, nylon housing

**Length:** 1.625" (41.28mm)

**Rating:** 10 Amps

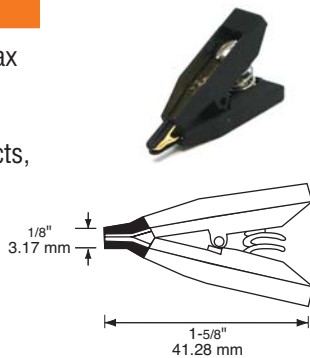

### Kelvin Clip

**Model # BU-78K**

Jaw opens 0.5" (12 mm) max

Isolated jaws

**Material:** Gold contacts

**Length:** 2.28" (57.91mm)

**Rating:** 10 Amps

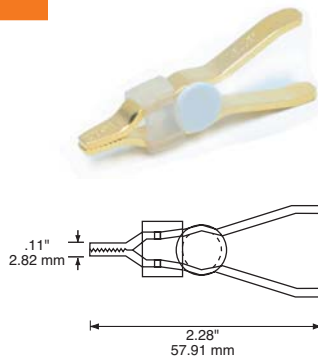

### Small Angled Nose Telecom Clip with Bed of Nails

**Model # JP-25182-\*\*\***

Mueller – J.S. Popper brand

Jaw opens 1.0" (25.4mm)

Uses bed of nails to pierce insulation

**Material:** nickel-silver jaws; includes brass screw, brass nut, brass washer, and bronze star washer

**Length:** 2.34" (59.4mm)

**Connection Options:** -N Without Hardware, -L With Loose Hardware, -J Banana Jack, -TJ Threaded Banana Jack

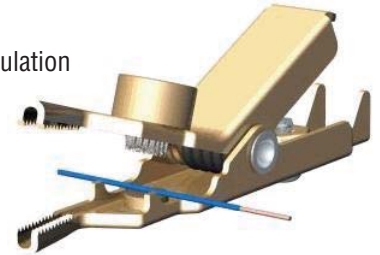

### Large Angled Nose Telecom Clip with Single Spike

**Model # JP-8099-\*\*\***

Mueller – J.S. Popper brand

Jaw opens 1.0" (25.4mm)

Uses single spike to pierce insulation

**Material:** nickel-silver jaws; includes brass screw, brass nut, brass washer, and bronze star washer

**Length:** 2.61" (66.4mm)

**Connection Options:** -N Without Hardware, -L With Loose Hardware, -J Banana Jack, -TJ Threaded Banana Jack



### Large Angled Nose Telecom Clip with Hex Screw Attached Single Spike

**Model # JP-8078-\*\*\***

Mueller – J.S. Popper brand

Jaw opens 1.0" (25.4mm)

Uses single spike to pierce insulation

**Material:** nickel-silver jaws; includes brass screw, brass nut, brass washer, and bronze star washer

**Length:** 2.61" (66.4mm)

**Connection Options:** -N Without Hardware, -L With Loose Hardware, -J Banana Jack, -TJ Threaded Banana Jack

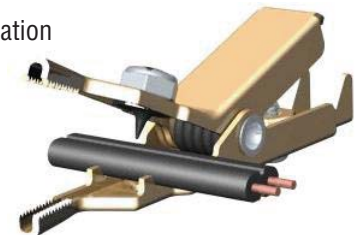

## Large Angled Nose Telecom Clip with Bed of Nails and Single Spike

**Model # JP-8783-\*\*\***

Mueller – J.S. Popper brand

Jaw opens 1.0" (25.4mm)

Uses single spike and bed of nails to pierce insulation

**Material:** nickel-silver jaws; includes brass screw, brass nut, brass washer, and bronze star washer

**Length:** 2.61" (66.4mm)

**Connection Options:** -N Without Hardware, -L With Loose Hardware, -J Banana Jack, -TJ Threaded Banana Jack



## Large Straight Nose Telecom Clip with Single Spike

**Model # JP-33699-\*\*\***

Mueller – J.S. Popper brand

Jaw opens 1.0" (25.4mm)

Uses single spike to pierce insulation

**Material:** nickel-silver jaws; includes brass screw, brass nut, brass washer, and bronze star washer

**Length:** 2.61" (66.4mm)

**Connection Options:** -N Without Hardware, -L With Loose Hardware, -J Banana Jack, -TJ Threaded Banana Jack

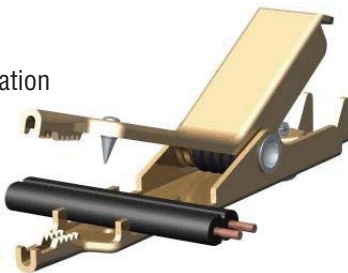

## Large Straight Nose Telecom Clip with Bed of Nails and Single Spike

**Model # JP-33674-\*\*\***

Mueller – J.S. Popper brand

Jaw opens 1.0" (25.4mm)

Uses single spike and bed of nails to pierce insulation

**Material:** nickel-silver jaws; includes brass screw, brass nut, brass washer, and bronze star washer

**Length:** 2.61" (66.4mm)

**Connection Options:** -N Without Hardware, -L With Loose Hardware, -J Banana Jack, -TJ Threaded Banana Jack

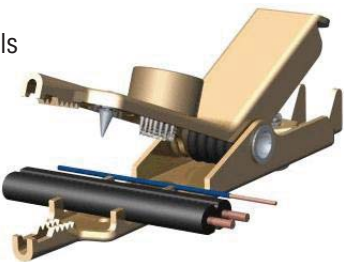

## Contact Clip with Bed of Nails

**Model #JP-5869-B**

Mueller – J.S. Popper brand

Jaw opens 0.52" (13.2mm)

Uses bed of nails to pierce insulation

**Material:** steel

**Length:** 2.4" (61.0mm)



## Contact Clip with Circle of Nails

**Model # JP-5869-C**

Mueller – J.S. Popper brand

Jaw opens 0.52" (13.2mm)

Uses circle of points to pierce insulation

**Material:** steel

**Length:** 2.4" (61.0mm)



## Insulator for Telecom Clips

**Model # JP-8681-\***

Mueller – J.S. Popper brand

Protective flexible vinyl insulator for 25182, 8099, 8078, 8783, 33699, 33674

**Material:** PVC

**Length:** 2.4" (61.0mm)

**\*Std. Colors:** -0 Black, -2 Red, -4 Yellow, -5 Green, -6 Blue, -9 White



## Cut Insulator for Telecom Clips

**Model # JP-8681-C\***

Mueller – J.S. Popper brand

Protective flexible vinyl insulator for telecom clips with banana jack or threaded banana jack connections

**Material:** PVC

**Length:** 1.8" (45.7mm)

**\*Std. Colors:** -0 Black, -2 Red, -4 Yellow, -5 Green, -6 Blue, -9 White

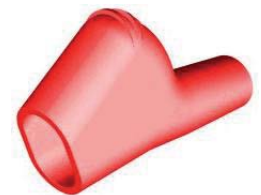



Mueller's jacks, binding posts and banana plugs ensure a reliable connection. All plug bodies are nickel-plated brass. Shielded jacks provide additional user safety where it is required.

Color Key		
0=Black	4=Yellow	6=Blue
2=Red	5=Green	9=White

### Banana Plug With 8-32 Thread

**Model # BU-00226-\***

Nine leaf cage spring 4mm banana plug

**Material:** *Banana Plug:* nickel-plated brass body; *Spring:* nickel-plated phosphor bronze; *Insulator:* ABS

**Length:** 1.66" (42.13mm)

**\*Std. Colors:** -0 Black, -2 Red

**Rating:** 1000 Volts, 15 Amps (hands free)

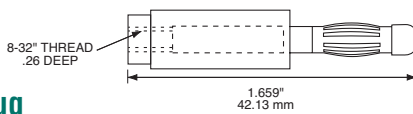

### Threaded Banana Plug

**Model # BU-00241**

**Material:** *Banana Plug:* nickel-plated brass body; *Spring:* nickel-plated phosphor bronze

**Length:** 1.21" (31mm)

**Rating:** 15 Amp



### Solderless Banana Plug

**Model # BU-00243-\***

**Material:** *Banana Plug:* nickel-plated brass body; *Spring:* nickel-plated phosphor bronze; *Insulator:* ABS

**Length:** 1.1" (28mm)

**\*Std. Colors:** -0 Black, -2 Red

**Rating:** 15 Amp



### Solderless Banana Plug-Hex Design

**Model # BU-00244-\***

**Material:** *Banana Plug:* nickel-plated brass body; *Spring:* nickel-plated phosphor bronze; *Insulator:* ABS

**Length:** 1.15" (29mm)

**\*Std. Colors:** -0 Black, -2 Red

**Rating:** 15 Amps

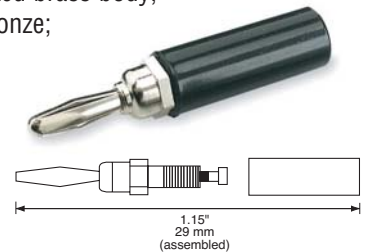

### Set Screw Banana Plug

**Model # BU-00245-\***

**Material:** *Banana Plug:* nickel-plated brass body; *Spring:* nickel-plated phosphor bronze; *Insulator:* ABS

**Length:** 1.08" (27mm)

**\*Std. Colors:** -0 Black, -2 Red

**Rating:** 15 Amps

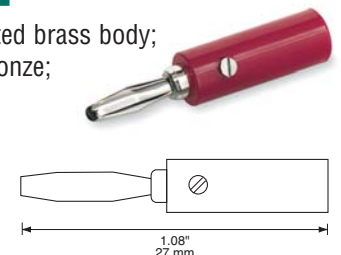

# Banana Plugs and Jacks

## Tapered Handle Banana Plug

Model # BU-00246-\*

**Material:** *Banana Plug:* nickel-plated brass body; *Spring:* nickel-plated phosphor bronze; *Insulator:* ABS

**Length:** 1.02" (26mm)

**\*Std. Colors:** -0 Black, -2 Red

**Rating:** 15 Amps

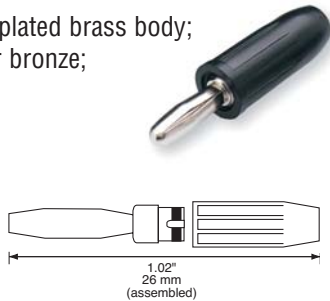

## Stackable Banana Plug

Model # BU-00249-\*

**Material:** *Banana Plug:* nickel-plated brass body; *Spring:* nickel-plated phosphor bronze; *Insulator:* ABS

**Length:** 1.68" (43mm)

**\*Std. Colors:** -0 Black, -2 Red

**Rating:** 15 Amps



## Unshrouded Stackable Banana Plug

Model # BU-16-\*

**Material:** *Banana Plug:* nickel-plated brass body; *Spring:* nickel-plated beryllium copper; *Insulator:* Nylon

**Length:** 1.88" (47.7mm)

**\*Std. Colors:** -0 Black, -2 Red

**Rating:** 1000 Volts, 15 Amps  
(Hands free)



## Insulated Stackable Banana Plug

Model # BU-31101-\*

**Material:** *Banana Plug:* nickel-plated brass body; *Spring:* nickel-plated beryllium copper; *Insulator:* nylon

**Length:** 2.45" (62.23mm)

**\*Std. Colors:** -0 Black, -2 Red

**Rating:** 20 Amps



## Cable Mountable 4mm Shrouded Banana Plug

Model # BU-32603-\*

**Material:** *Banana Plug:* nickel-plated brass; *Insulator:* nylon

**Length:** 1.91" (48.5mm)

**\*Std. Colors:** -0 Black, -2 Red

**Rating:** 1000V, category III, 1500V,  
category II, 20 Amps,  
IEC 1010 Compliant



## Insulated Banana Jack To Standard Banana Plug

Model # BU-32101-\*

**Material:** *Banana Plug:* nickel-plated brass body; *Spring:* nickel-plated beryllium copper; *Insulator:* nylon

**Length:** 2.61" (66.3mm)

**\*Std. Colors:** -0 Black, -2 Red,  
-4 Yellow, -6 Blue

**Rating:** 1000 V, 15 Amps (hands  
free), IEC 1010 Compliant



## Insulated Banana Coupler

Model # BU-32601-\*

**Material:** *Banana Plug:* nickel-plated  
brass; *Insulator:* nylon

**Length:** 2.50" (63.5mm)

**\*Std. Colors:** -0 Black, -2 Red,  
-4 Yellow, -6 Blue

**Rating:** 1000V, 15 Amps, IEC 1010 Compliant



## Dual Banana Plug

Model # BU-00247-\*

**Material:** *Banana Plug:* nickel-plated brass body; *Spring:* nickel-plated phosphor bronze; *Insulator:* PVC

**Length:** 1.62" (41mm)

**\*Std. Colors:** -0 Black, -2 Red,  
-4 Yellow, -5 Green, -6 Blue

**Rating:** 15 Amps

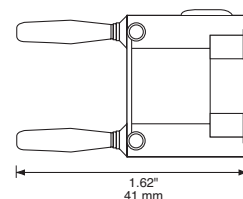

### Insulated Banana Jack

**Model # BU-00233-\***

**Material:** *Banana Jack:* nickel-plated brass body; *Insulator:* nylon

**Length:** 0.66" (17mm)

**\*Std. Colors:** -0 Black, -2 Red

**Rating:** 15 Amp

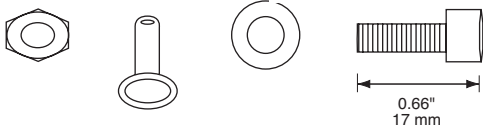

### Insulated Phone Tip Jack

**Model # BU-00234-\***

**Material:** *Banana Jack:* nickel-plated brass body; *Spring:* nickel-plated phosphor bronze; *Insulator:* ABS

**Length:** 1" (25mm)

**\*Std. Colors:** -0 Black, -2 Red

**Rating:** 15 Amp

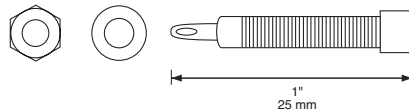

### Pressfit Insulated Banana Jack with Solder Pin Connection

**Model # BU-31602-\***

**Material:** *Banana Plug:* nickel-plated brass; *Insulator:* Dupont 101L

**Length:** 1.25" (31.75mm)

**\*Std. Colors:** -0 Black, -2 Red, -4 Yellow, -6 Blue

**Rating:** 1000 V, 15 Amps, IEC 1010 Compliant



### Pressfit Insulated Banana Jack with Spade Connection

**Model # BU-31603-\***

**Material:** *Banana Plug:* nickel-plated brass; *Insulator:* Dupont 101L

**Length:** 1.37" (34.8mm)

**\*Std. Colors:** -0 Black, -2 Red, -4 Yellow, -6 Blue

**Rating:** 1000 V, 15 Amps, IEC 1010 Compliant



### Slim-Line Five Way Binding Post-Threaded

**Model # BU-00281-\***

**Material:** *Post:* nickel-plated brass; *Insulator:* nylon

**Length:** 2" (51mm)

**\*Std. Colors:** -0 Black, -2 Red

**Rating:** 15 Amps

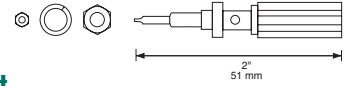

### Five-Way Binding Post

**Model # BU-00282-\***

**Material:** *Post:* nickel-plated brass; *Insulator:* nylon

**Length:** 2.10" (53mm)

**\*Std. Colors:** -0 Black, -2 Red

**Rating:** 15 Amps



### Dual Five-Way Binding Post

**Model # BU-00283**

**Material:** *Post:* nickel-plated brass; *Insulator:* nylon

**Length:** 1.80" (46mm)

**Rating:** 15 Amps

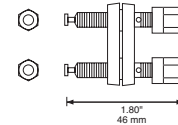
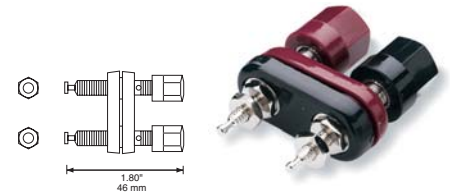

### Screw-in Safety Socket with Stud and Metal Nut

**Model # BU-31607-\***

**Material:** *Hardware:* nickel-plated brass; *Insulator:* ABS-nylon composite

**Length:** 1.53" (39mm)

**\*Std. Colors:** -0 Black, -2 Red

**Rating:** 600V, category III, 1000V, category II, 35 Amps, IEC 1010 Compliant



### Screw-in Safety Socket with Spade and Metal Nut

**Model # BU-31609-\***

**Material:** *Hardware:* nickel-plated brass; *Insulator:* ABS-nylon composite

**Length:** 1.26" (32mm)

**\*Std. Colors:** -0 Black, -2 Red

**Rating:** 600V, category III, 1000V, category II, 35 Amps, IEC 1010 Compliant



# Grabbers, Probes and Spade Terminals

Mueller grabber clips and test probes are available in a wide variety of sizes to ensure that even the most hard to reach test point is easily accessible. We provide a fast and easy connection to terminals and component test leads.



## Color Key

0=Black	4=Yellow	6=Blue
2=Red	5=Green	9=White

### Plunger Clip

Model # BU-00201-\*/BU-00202-\*/BU-00203-\*

**Material:** Cap & Body: glass filled nylon; Spring: stainless steel; Contact: beryllium copper; insulated to a single contact point

**Length:** 1.75" (44mm) (BU-00201-\*); 2.50" (63mm) (BU-00202-\*); 3.50" (88mm) (BU-00203-\*)

\*Std Colors: -0 black, -2 red

**Rating:** 1000 Volts, 10 Amps



### Mini-Micro Plunger Clip

Model # BU-00208-\*

**Material:** Cap & Body: tough, durable nylon; Spring: stainless steel compression coil; Contact: gold-plated beryllium copper

**Length:** 1.75" (44mm)

\*Std Colors: -0 Black, -2 Red

**Rating:** 600 Volts, 3 Amps



### Safety Plunger Clip Adapter

Model # BU-00207-\*

**Material:** Cap & Body: nylon; Spring: stainless steel; Contact: beryllium copper

**Length:** 2.23" (56.64mm)

\*Std Colors: -0 Black, -2 Red

**Rating:** 1000 Volts, 15 Amps



### Right Angle Insulated Plunger Hook Clip

Model # BU-20431-\*

Compatible with all shrouded, unshrouded, or retractable 0.16" (4mm) banana plugs

**Material:** Housing: nylon. Contact: nickel-plated beryllium copper

**Length:** 4.60" (116.84mm); the hook extends 0.41" (10mm) when fully depressed

\*Std Colors: -0 Black, -2 Red, -4 Yellow, -6 Blue

**Rating:** 1000V, 15 Amps, IEC 1010 Compliant



### Right Angle Insulated Plunger Clamp Clip

**Model # BU-20432-\*/BU-20433-\***

Compatible with all shrouded, unshrouded, or retractable 0.16" (4mm) banana plugs

**Material:** *Housing:* nylon;  
*Contact:* nickel-plated beryllium copper

**Length:** 5.50" (139.7mm) (BU-20432-\*);  
7.50" (190.5mm) (BU-20433-\*)

**\*Std Colors:** -0 Black, -2 Red, -4 Yellow, -6 Blue

**Rating:** 1000V, 1 Amps, IEC 1010 Compliant



### Right Angle Insulated Plunger Jaw Clip

**Model # BU-20434-\***

Compatible with all shrouded, unshrouded, or retractable 0.16" (4mm) banana plugs

**Material:** *Housing:* nylon;  
*Contact:* nickel-plated steel

**Length:** 5.26" (133.6mm); the steel jaws extend 0.48" (12mm) and open to 1" (25mm)

**\*Std Colors:** -0 Black, -2 Red, -4 Yellow, -6 Blue

**Rating:** 1000V, 15 Amps, IEC 1010 Compliant



### Insulated Plug-On Test Prod With Stainless Steel Tip

**Model # BU-26101-\***

Compatible with all shrouded, unshrouded, or retractable 0.16" (4mm) banana plugs

**Material:** *Housing:* nylon;  
*Contact:* nickel-plated brass

**Length:** 3" (76.2mm)

**\*Std Colors:** -0 Black, -2 Red, -4 Yellow, -6 Blue

**Rating:** 1000V, 20 Amps, IEC 1010 Compliant



### Insulated Plug-On Test Prod With 8-32 Thread

**Model # BU-26106-\***

Compatible with all shrouded, unshrouded, or retractable 0.16" (4mm) banana plugs

**Material:** *Housing:* nylon;  
*Contact:* nickel-plated brass

**Length:** 3.3" (83mm)

**\*Std Colors:** -0 Black, -2 Red, -4 Yellow, -6 Blue

**Rating:** 1000V, 20 Amps, IEC 1010 Compliant



### Ultra Tech Test Prod

**Model # BU-26130-\***

Compatible with all shrouded, unshrouded, or retractable 0.16" (4mm) banana plugs

**Material:** *Housing:* nylon;  
*Contact:* nickel-plated brass

**Length:** 6.27" (159.3mm)

**\*Std Colors:** -0 Black, -2 Red, -4 Yellow, -6 Blue

**Rating:** 1000V, IEC 1010 Compliant



### Safety Spade Terminal

**Model # BU-30214-\***

Compatible with all shrouded, unshrouded, or retractable 0.16" (4mm) banana plugs

**Material:** *Housing:* ABS-nylon;  
*Contact:* nickel-plated brass

**Length:** 2.55" (64.8mm)

**\*Std Colors:** -0 Black, -2 Red, -4 Yellow, -5 Green, -6 Blue

**Rating:** 1000V, category III, 1500V, category II, 30 Amps, IEC 1010 Compliant







# Test Leads and Patch Cords

Mueller manufactures a full line of test and interconnection leads for almost any application. For nearly a century, technicians and engineers have looked to Mueller as “perfection...for the best connection.”

## Wire Table

Designation	AWG	Description	O.D.	Insulation	Temp	Rating
M	18	413/44 copper	.140" (3.56mm)	Silicone	150°C/-80°C	3000V, 22A
N	18	65/36 tinned copper	.140" (3.56mm)	PVC	80°C/-50°C	5000V, 6.5A
A	20	41/36 tinned copper	.088" (2.24mm)	PVC	105°C/-25°C	300V, 6.5A
E	22	19/34 tinned copper	.062" (1.56mm)	PVC	105°C/-55°C	1000V, 600V UL1483, 300V UL1509, 3.5A
D	18	65/36 tinned copper	.140" (3.56mm)	PVC	90°C	3000V, 6.5A

## Order Key

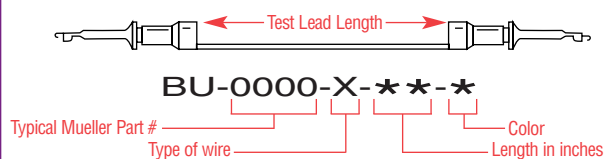

## Coaxial Cables

Rating
B RG-58C/U
C RG-58C/U connected to 20AWG with Y-block
F RG-174C/U
L Twisted Pair Cable

## Micro-Plunger Clip on Both Ends

Model # BU-1010-A-\*\*-\*

## Mini-Plunger Clip on Both Ends

Model # BU-1111-A-\*\*-\*

**Material:** Hook-up Wire: #20 (41/36) AWG tinned copper with 105°C PVC insulation; Plunger: nylon housing, stainless steel spring, beryllium copper contact

**\*\*Length:** -12" (.3m), 24" (.6m), 36" (.9m), 48" (1.2m), 60" (1.5m)

**\*Std. Colors:** -0 Black, -2 Red

**Rating:** Hands free testing at 300V Category II, 5 Amps



## Mini-Plunger to Stackable Banana Plug

Model # BU-1120-A-\*\*-\*

**Material:** Banana Plug: ABS housing, brass body and beryllium copper, nickel-plated, nine-leaf cage spring; Hook-up Wire: #20 (41/36) AWG tinned copper with 105°C PVC insulation; Plunger: nylon housing, stainless steel spring and beryllium copper contact

**\*\*Length:** -12" (.3m), 24" (.6m), 36" (.9m), 48" (1.2m), 60" (1.5m)

**\*Std. Colors:** -0 Black, -2 Red

**Rating:** Hands free testing at 300V, 5 Amps



## Mini-Plunger to BNC Male with RG58

Model # BU-1150-C-\*\*-0

**Material:** BNC Connector: MIL-C-30912, gold-plated center contact and silver-plated body; Coaxial Cable: shielded RG58C/U, MIL-C-17F, 50 ohm; Plunger: nylon housing, stainless steel spring and beryllium copper contact

**\*\*Length:** -12" (.3m), 24" (.6m), 36" (.9m), 48" (1.2m), 60" (1.5m)

**Rating:** Hands free testing at 300 VRMS



## Mini-Micro-Plunger to Stackable Banana Plug

Model # BU-1420-A-\*\*-\*

**Material:** Banana Plug: ABS housing, brass body and beryllium copper, nickel-plated, nine-leaf cage spring; Hook-up Wire: #20 (41/36) AWG tinned copper with 105°C PVC insulation; Plunger: nylon housing, stainless steel spring and gold-plated, beryllium copper contact

**\*\*Length:** -12" (.3m), 24" (.6m), 36" (.9m), 48" (1.2m), 60" (1.5m)

**\*Std. Colors:** -0 Black, -2 Red

**Rating:** Hands free testing at 300V, 5 Amp



## Stackable Single Banana Plugs on Both Ends

Model # BU-2020-A-\*\*-\*

**Material:** *Banana Plug:* ABS housing, brass body and beryllium copper, nickel-plated, nine-leaf cage spring; *Hook-up Wire:* #20 (41/36) AWG tinned copper with 105°C PVC insulation

**\*\*Length:** -12" (.3m), 24" (.6m), 36" (.9m), 48" (1.2m), 60" (1.5m)

**\*Std. Colors:** -0 Black, -2 Red

**Rating:** hands free testing at 300V, 10 Amps



## Insulated Alligator Clip to Stackable Banana Plug

Model # BU-2030-A-\*\*-\*

**Material:** *Banana Plug:* ABS housing, brass body and beryllium copper, nickel-plated, nine-leaf cage spring; *Alligator Clip:* nickel-plated steel with PVC insulator; *Hook-up Wire:* #20 (41/36) AWG tinned copper with 105°C PVC insulation

**\*\*Length:** -12" (.3m), 24" (.6m), 36" (.9m), 48" (1.2m), 60" (1.5m)

**\*Std. Colors:** -0 Black, -2 Red

**Rating:** hands free testing at 300V, 10 Amps



## Insulated Mini-Alligator Clip to Stackable Banana Plug

Model # BU-2031-A-\*\*-\*

**Material:** *Banana Plug:* ABS housing, brass body and beryllium copper, nickel-plated, nine-leaf cage spring; *Alligator Clip:* nickel-plated steel with PVC insulator; *Hook-up Wire:* #20 (41/36) AWG tinned copper with 105°C PVC insulation

**\*\*Length:** -12" (.3m), 24" (.6m), 36" (.9m), 48" (1.2m), 60" (1.5m)

**\*Std. Colors:** -0 Black, -2 Red

**Rating:** Hands free testing at 300V, 10 Amp



## Multiple Feature Test Prod to Right Angle Shrouded Banana Plug

Model # BU-2241-D-48-\*

**Material:** *Needle:* stainless steel; *Banana plugs:* nickel-plated brass; *Housing:* ABS; *Hook-up wire:* #18 AWG (65/36) tinned copper with 90°C PVC insulation

**\*Std. Colors:** -0 Black, -2 Red

**Rating:** 1000V Category II, 20 Amps



## Shrouded Right Angle Banana Plug

Model # BU-2243-D-48-\*

The stainless steel probe is Teflon® insulated except for the working end to prevent unwanted contact with other components that may be in the way

**Material:** *Needle:* stainless steel; *Banana Plugs:* nickel-plated brass; *Housing:* ABS; *Hook-up wire:* #18 AWG (65/36) tinned copper with 90°C PVC insulation

**\*Std. Colors:** -0 Black, -2 Red

**Rating:** 600V Category II, 20 Amps



## Multiple Feature Test Prod to Unshrouded Banana Plug

Model # BU-2641-D-48-\*

**Material:** *Needle:* stainless steel; *Banana Plugs:* nickel-plated brass; *Housing:* ABS; *Hook-up wire:* #18 AWG (65/36) tinned copper with 90°C PVC insulation

**\*Std. Colors:** -0 Black, -2 Red

**Rating:** 600V, 10 Amps



## Multiple Feature Test Prod to Unshrouded Right Angle Banana Plug

Model # BU-2741-D-48-\*

**Material:** *Needle:* stainless steel; *Banana plugs:* nickel-plated brass; *Housing:* ABS; *Hook-up wire:* #18 AWG (65/36) tinned copper with 90°C PVC insulation

**\*Std. Colors:** -0 Black, -2 Red

**Rating:** 600V, 10 Amps



## Unshrouded Banana Plugs on Both Ends – Ultra-Flex-Silicone

Model # BU-2929-M-\*\*-\*

**Material:** *Unshrouded Banana Plugs:* Mueller No. Bu-16-\*; *Hook-up wire:* #18 AWG (65/36) tinned copper with 90°C PVC insulation

**\*\*Length:** -10" (.25m), 20" (.5m), 39" (1m)

**\*Std. Colors:** -0 Black, -2 Red

**Rating:** Hands free testing at 3 kV, 20 Amps



## Shrouded Banana Plug to Safety Test Prod - Silicone

Model # BU-4061-M-39-\*

**Material:** *Banana Plugs:* nickel-plated brass body, nickel-plated beryllium copper spring; *Probe:* stainless steel tip with 8-32 UNC thread; *Hook-up Wire:* #18 AWG, silicone insulator

\*Std. Colors: -0 Black, -2 Red, -4 Yellow, -6 Blue

**Rating:** 1000V, 20 Amps, IEC 1010 compliant



## Shrouded Right Angle Banana Plug to Safety Test Prod - Silicone

Model # BU-4062-M-39-\*

**Material:** *Banana Plugs:* nickel-plated brass body, nickel-plated beryllium copper spring; *Probe:* stainless steel tip with 8-32 UNC thread; *Hook-up Wire:* #18 AWG, silicone insulator

\*Std. Colors: -0 Black, -2 Red, -4 Yellow, -6 Blue

**Rating:** 1000V, 20 Amps, IEC 1010 compliant



## Stackable 0.080" (2.0mm) Pin Plug on Both Ends

Model # BU-4444-A-\*\*-\*

Tip jack accepts 0.080" (2.0mm) diameter pin jack contact

**Material:** *Pin Plug:* 0.080" (2.0mm) diameter; 0.500" (12.7mm) long, nickel-plated brass pin tip, nickel-plated beryllium copper spring, ABS housing; *Hook-up Wire:* #22 (19/34) AWG tinned copper with 105°C PVC insulation

\*\*Length: -12" (.3m), 24" (.6m), 36" (.9m)

\*Std. Colors: -0 Black, -2 Red

**Rating:** Hands free testing at 300VAC, 15 Amps



## Shrouded Banana Plug on Both Ends – Silicone

Model # BU-6161-M-39-\*

**Material:** *Banana Plugs:* nickel-plated brass body, nickel-plated beryllium copper spring; *Hook-up Wire:* #18 AWG, silicone insulator

\*Std. Colors: -0 Black, -2 Red, -4 Yellow, -6 Blue

**Rating:** 1000V, 20 Amps, IEC 1010 compliant



## Right Angle Shrouded Banana Plug to Shrouded Banana Plug - Silicone

Model # BU-6162-M-39-\*

**Material:** *Banana Plugs:* nickel-plated brass body, nickel-plated beryllium copper spring; *Hook-up Wire:* #18 AWG, silicone insulator

\*Std. Colors: -0 Black, -2 Red, -4 Yellow, -6 Blue

**Rating:** 1000V, 20 Amp, IEC 1010 compliant



## Stackable Dual Banana Plug to Mini-Micro-Plunger with RG58

Model # BU-7014-B-\*\*-\*

**Material:** *Plunger:* nylon housing, stainless steel spring and beryllium copper contact; *Double Banana Plug:* ABS housing, brass body and beryllium copper, nickel-plated, nine-leaf cage spring; *Coaxial Cable:* shielded RG58C/U, MIL-C-17F, 50 ohm

\*\*Length: -12" (.36m), 24" (.6m), 36" (.9m)

\*Std. Colors: -0 Black, -2 Red

**Rating:** hands free testing at 300 VRMS



## Stackable Dual Banana Plug to Stackable Single Banana Plug with RG58

Model # BU-7020-B-\*\*-\*

**Material:** *Single Banana Plug:* ABS housing, brass body and beryllium copper, nickel-plated, nine-leaf cage spring; *Double Banana Plug:* ABS housing, brass body and beryllium copper, nickel-plated, nine-leaf cage spring; *Coaxial Cable:* shielded RG58C/U, MIL-C-17F, 50 ohm

\*\*Length: -12" (.36m), 24" (.6m), 36" (.9m)

\*Std. Colors: -0 Black, -2 Red

**Rating:** Hands free testing at 500 VRMS



## Stackable Dual Banana Plug to Mini-Alligator Clip with RG58

**Model # BU-7031-B-\*\*-\***

**Material:** *Alligator clip:* nickel-plated steel with PVC insulator; *Double Banana Plug:* ABS housing, brass body and beryllium copper, nickel-plated, nine-leaf cage spring; *Coaxial Cable:* shielded RG58C/U, MIL-C-17F, 50 ohm

**\*\*Length:** -12" (.36m), 24" (.6m), 36" (.9m)

**\*Std. Colors:** -0 Black, -2 Red

**Rating:** Hands free testing at 300 VRMS



## Stackable Dual Banana Plug to Stackable Pin Plug with RG58

**Model # BU-7044-B-\*\*-\***

**Material:** *Pin Plug:* 0.080" (2.0mm) diameter; 0.500" (12.7mm) long, nickel-plated brass pin tip, nickel-plated beryllium copper spring, ABS housing; *Double Banana Plug:* ABS housing, brass body and beryllium copper, nickel-plated, nine-leaf cage spring; *Coaxial Cable:* shielded RG58C/U, MIL-C-17F, 50 ohm

**\*\*Length:** -12" (.36m), 24" (.6m), 36" (.9m)

**\*Std. Colors:** -0 Black, -2 Red

**Rating:** Hands free testing at 500 VRMS



## Stackable Dual Banana Plug on Both Ends with RG58

**Model # BU-7070-B-\*\*-\***

**Material:** *Double Banana Plug:* ABS housing, brass body and beryllium copper, nickel-plated, nine-leaf cage spring; *Coaxial Cable:* shielded RG58C/U, MIL-C-17F, 50 ohm

**\*\*Length:** -12" (.3m), 24" (.6m), 36" (.9m), 48" (1.2m), 60" (1.5m)

**\*Std. Colors:** -0 Black, -2 Red

**Rating:** Hands free testing at 300 VRMS



## Shrouded Dual Banana Plug on Both Ends with RG58

**Model # BU-7171-B-\*\*-0**

**Material:** *Double Banana Plug:* ABS housing, brass body and beryllium copper, nickel-plated, nine-leaf cage spring; *Coaxial Cable:* shielded #22 AWG (7/30) twisted pair with drain connected to (-) side of one banana plug; side with drain connection is marked; shielded RG58C/U, MIL-C-17F, 50 ohm

**\*\*Length:** -12" (.3m), 24" (.6m), 36" (.9m), 48" (1.2m), 60" (1.5m)

**Rating:** Hands free testing at 500 VRMS



## 0.025" (.6mm) Square Pin Receptacle on Both Ends

**Model # BU-8080-E-\*\*-\***

**Material:** *Pin Receptacle:* ABS housing, 0.025" (0.6mm) copper-nickel-tin alloy 725 with 0.000030" (0.00076mm) gold contact plating conductor; *Hook-up Wire:* #22 AWG (19/34) tinned copper with 105°C PVC insulation

**\*\*Length:** -6" (.15m), 12" (.3m), 24" (.6m), 36" (.9m)

**\*Std. Colors:** -0 Black, -2 Red

**Rating:** Hands free testing at 300V, 3 Amp



## Insulated Alligator Clips on Both Ends

**Model # BU-3030-A-\*\*-\***

**Material:** *Alligator Clip:* nickel-plated steel with PVC insulator; *Hook-up Wire:* #20 (41/36) AWG tinned copper with 105°C PVC insulation

**\*\*Length:** -12" (.3m), 24" (.6m), 36" (.9m), 48" (1.2m), 60" (1.5m)

**\*Std. Colors:** -0 Black, -2 Red

**Rating:** Hands free testing at 300V, 10 Amps



## Insulated Alligator Clips on Both Ends - Coiled Cord

**Model # BU-3030-C-24-\***

**Material:** *Clip:* nickel-plated steel alligator with insulator (BU-60 and BU-62-\*); *Coiled Cord:* single conductor 18AWG wire with 4mm O.D.

**Length:** -24" (.6m) retracted, 120" (3.) extended

**\*Std. Colors:** -0 Black, -2 Red

**Rating:** Hands free testing at 300V, 15 Amps



## Insulated Alligator Clip to Stackable Dual Banana Plug with RG58

Model # BU-3070-C-\*\*-0

**Material:** *Alligator Clip:* nickel-plated steel with PVC insulator; *Double Banana Plug:* ABS housing, brass body and beryllium copper, nickel-plated, nine-leaf cage spring; *Coaxial Cable:* Shielded RG58C/U, MIL-C-17F, 50 ohm

**\*\*Length:** -12" (.3m), 24" (.6m), 36" (.9m), 48" (1.2m), 60" (1.5m)

**Rating:** Hands free testing at 300 VRMS



## Insulated Mini-Alligator Clip on Both Ends

Model # BU-3131-A-\*\*-\*

**Material:** *Alligator Clip:* nickel-plated steel with PVC insulator; *Hook-up Wire:* #20 (41/36) AWG tinned copper with 105°C PVC insulation

**\*\*Length:** -12" (.3m), 24" (.6m), 36" (.9m), 48" (1.2m), 60" (1.5m)

**\*Std. Colors:** -0 Black, -2 Red

**Rating:** Hands free testing at 300 VAC, 5 Amps



## Insulated Mini-Alligator Lead Set

Model # BU-00285

**Material:** *Clip:* nickel-plated steel with PVC insulators; *Hook-up Wire:* #22 (19/34) AWG copper with 105°C PVC insulation

**Length:** 18" (.46m)

**Colors:** Includes 2 each: Black, Red, Yellow, Green, White

**Rating:** Hands free testing at 300V, 5 Amp



## Insulated Alligator Lead Set

Model # BU-00286

**Material:** *Clip:* nickel-plated steel with PVC insulators; *Hook-up Wire:* #22 (19/34) AWG copper with 105°C PVC insulation

**Length:** 12" (.3m)

**Colors:** Includes 1 each: Black, Red, Yellow, Green, White

**Rating:** Hands free testing at 300V, 7 Amp



## Insulated Alligator Lead Set

Model # BU-00287

**Material:** *Clip:* nickel-plated steel with PVC insulators; *Hook-up Wire:* #22 (19/34) AWG copper with 105°C PVC insulation

**Length:** 12" (.3m)

**Colors:** Includes 2 each: Black, Red, Yellow, Green, White

**Rating:** Hands free testing at 300V, 7 Amp



## Shrouded Banana Plug to Piercing Clip - Silicone

Model # JP-7505-83-\*\*-\*

Piercing clips are J.S. Popper brand

**Material:** *Piercing Clip:* JP-8783; *Banana Plugs:* nickel-plated brass body, nickel-plated beryllium copper spring; *Hook-up Wire:* #18 AWG, silicone insulator

**\*\*Length:** -12" (.3m), 24" (.6m), 36" (.9m), 48" (1.2m)

**\*Std. Colors:** -0 Black, -2 Red, -4 Yellow, -6 Blue

**Rating:** 300V, 3 Amp



## Ultra-Flex Test Lead Wires

Model # WI-M-18-\*

**Material:** *Wire:* #18 AWG, silicone

**\*Std. Colors:** -0 Black, -2 Red, -4 Yellow, -5 Green, -6 Blue, -9 White

**Rating:** 3kV, 22 Amp



Mueller's coaxial cables and fully insulated BNC receptacles provide an additional margin of safety in connecting to instrumentation such as oscilloscopes, voltmeters, and network analyzers. Our BNC breakout test leads offer a wide variety of connector and clip combinations to meet your testing and connection needs.

Order Key		Coaxial Cables			
		<b>Rating</b> B RG-58C/U C RG-58C/U connected to 20AWG with Y-block F RG-174C/U L Twisted Pair Cable			
<b>BU-0000-X-**-*</b> Typical Mueller Part #      Type of wire      Color      Length in inches					
Color Key		Available Test Lead Lengths			
0=Black	4=Yellow	6=Blue	6"	24"	48"
2=Red	5=Green	9=White	12"	36"	60"

### BNC Male on Both Ends

**Model # BU-5050-B-\*\*-0**

**Material:** *BNC Male Connector:* gold-plated center contact, silver-plated body; (MIL-C-39012); *Coaxial Cable:* shielded RG58C/U, MIL-C17F, 50 ohm

**\*\*Length:** -12" (.3m), 24" (.6m), 36" (.9m), 48" (1.2m), 60" (1.5m)

**Rating:** Hands free testing at 500 VRMS on center conductor



### BNC Male with Strain Relief on Both Ends

**Model# BU-5454-B-\*\*-0**

**Material:** *BNC Male Connector:* MIL-C-39012, silver-plated brass body, gold/nickel plated brass center contact; *Coaxial Cable:* RG58C/U, MIL-C17F, 50 ohm

**\*\*Length:** -12" (.3m), 24" (.6m), 36" (.9m), 48" (1.2m), 60" (1.5m)

**Rating:** Hands free testing at 500 VRMS on center conductor



### BNC Male to Stackable Double Banana Plug

**Model# BU-5070-B-\*\*-0**

**Material:** *BNC Male Connector:* gold-plated center contact, silver-plated body; (MIL-C-39012); *Double Banana Plug:* ABS housing, brass body and beryllium copper, nickel-plated, nine-leaf cage spring; *Coaxial Cable:* shielded RG58C/U, MIL-C-17F, 50 ohm

**\*\*Length:** -12" (.3m), 24" (.6m), 36" (.9m), 48" (1.2m), 60" (1.5m)

**Rating:** Hands free testing at 500 VRMS on center conductor



### BNC Female with Strain Relief on Both Ends

**Model# BU-5555-B-\*\*-0**

**Material:** *BNC Female Connector:* MIL-C-39012, silver-plated brass body, gold/nickel plated brass center contact; *Coaxial Cable:* RG58C/U, MIL-C17F, 50 ohm

**\*\*Length:** -12" (.3m), 24" (.6m), 36" (.9m), 48" (1.2m), 60" (1.5m)

**Rating:** Hands free testing at 500 VRMS on center conductor

## Insulated BNC Male to BNC Female

Model# BU-5659-B-\*\*-0

**Material:** *BNC Male/Female Connector:* fully insulated nylon housing; nickel-plated brass body, gold/nickel plated brass center contact; polyethylene dielectric; *Coaxial Cable:* RG58, 50 ohm

**\*\*Length:** -12" (.3m), 24" (.6m), 36" (.9m), 48" (1.2m), 60" (1.5m)

**Rating:** Hands free testing at 500 VRMS on center conductor



## Insulated Alligator Clips to BNC Male With RG58

Model# BU-5030-C-\*\*-0

## Insulated Alligator Clips to BNC Male With RG174

Model# BU-5330-F-\*\*-0

**Material:** *Alligator Clip:* nickel-plated steel with PVC insulator; *BNC Male Connector:* MIL-C-39012, gold-plated center contact and silver-plated body (RG174/U BNC is a commercial connector with nickel-plated body); *Coaxial Cable:* shielded RG58C/U, MIL-C-17F, 50 ohm or shielded RG174/U, MIL-C-17D, 50 ohm

**\*\*Length:** -12" (.3m), 24" (.6m), 36" (.9m), 48" (1.2m), 60" (1.5m)

**Rating:** Hands free testing at 300 VRMS on center conductor



## BNC Male Breakout to Tinned End Wires

Model# BU-5100-A-4-0

**Material:** *BNC Male Connector:* quality tarnish-resistant, plated brass with a gold-plated brass center contact, ABS housing; *Hook-up Wire:* #20 AWG (41/36) tinned copper with 105°C PVC insulation

**Rating:** Hands free testing at 300 VRMS on center conductor



## BNC Male Breakout to Mini-Micro-Grabbers

Model# BU-5114-A-4-0

**Material:** *BNC Male Connector:* quality tarnish-resistant, plated brass with a gold-plated brass center contact, ABS housing; *Mini-Micro-Grabbers* (No.208) conductor and abrasion resistant, nylon housing; *Hook-up Wire:* #20 AWG (41/36) tinned copper with 105°C PVC insulation

**Rating:** Hands free testing at 150 VRMS, 5 Amp



## BNC Male Breakout to Stackable Single Banana Plugs

Model# BU-5120-A-4-0

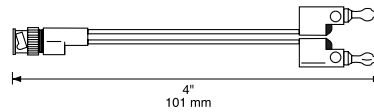

**Material:** *BNC Male Connector:* quality tarnish-resistant, plated brass with a gold-plated brass center contact, ABS housing; *Banana Plug:* premium nine-leaf, nickel-plated beryllium copper springs and copper alloy 360 bodies for minimum stacked in multiples, ABS housing; *Hook-up Wire:* #20 AWG (41/36) tinned copper with 105°C PVC insulation

**Rating:** Hands free testing at 300 VRMS, 5 Amp

## BNC Male Breakout to Insulated Mini-Alligator Clips

Model# BU-5131-A-4-0

**Material:** *BNC Male Connector:* quality tarnish-resistant, plated brass with a gold-plated brass center contact, ABS housing; *Clip:* Mueller No. 30BL with No. 31 insulators; *Hook-up Wire:* #20 AWG (41/36) tinned copper with 105°C PVC insulation

**Rating:** Hands free testing at 300 VRMS, 10 Amp



## BNC Male Breakout to Stackable 0.080" (2.0mm) Pin Plugs

Model# BU-5144-A-4-0

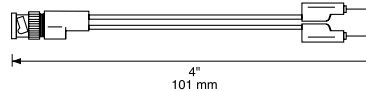

**Material:** *BNC Male Connector:* quality tarnish-resistant, plated brass with a gold-plated brass center contact, ABS housing; *Pin Tip:* nickel-plated brass 0.080" (2.0mm) dia; 0.500" (12.7mm) long; *Tip Jack:* Accepts 0.080" (2.0mm) dia. pin, nickel-plated, alloy 360 copper body; *Hook-up Wire:* #20 AWG (41/36) tinned copper with 105°C PVC insulation

**Rating:** Hands free testing at 300 VRMS, 5 Amps

## BNC Female Breakout Style to Tinned End Wires

Model# BU-5200-A-4-0

**Material:** *BNC Female Connector:* quality tarnish-resistant, plated brass with a gold-plated brass center contact, ABS housing; *Hook-up Wire:* #20 AWG (41/36) tinned copper with 105°C PVC insulation

**Rating:** Hands free testing at 300 VRMS, 5 Amp



## BNC Female Breakout to Insulated Mini-Alligator Clips

Model# BU-5231-A-4-0

**Material:** *BNC Female Connector:* quality tarnish-resistant, plated brass with a gold-plated brass center contact, ABS housing; *Clip:* Mueller No. 30BL with No. 31 insulators; *Hook-up Wire:* #20 AWG (41/36) tinned copper with 105°C PVC insulation

**Rating:** Hands free testing at 300 VRMS, 5 Amp



## BNC Female Breakout to Mini-Micro-Grabbers

Model# BU-5214-A-4-0

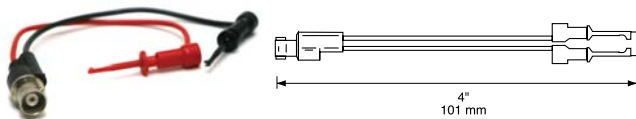

**Material:** *BNC Female Connector:* quality tarnish-resistant, plated brass with a gold-plated brass center contact, ABS housing; *Mini-Micro-Grabbers (No.208):* conductor and abrasion resistant, nylon housing; *Hook-up Wire:* #20 AWG (41/36) tinned copper with 105°C PVC insulation

**Rating:** Hands free testing at 300 VRMS, 5 Amp

## BNC Female Breakout to Stackable 0.080" (2.0mm) Pin Plugs

Model# BU-5244-A-4-0

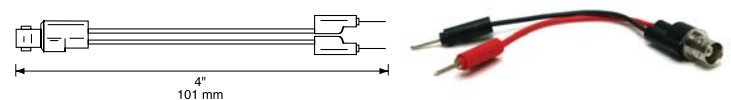

**Material:** *BNC Female Connector:* quality tarnish-resistant, plated brass with a gold-plated brass center contact, ABS housing; *Pin Tip:* nickel-plated brass 0.080" (2.0mm) dia; 0.500" (12.7mm) long; *Tip Jack:* accepts 0.080" (2.0mm) dia. pin, nickel-plated, alloy 360 copper body; *Hook-up Wire:* #20 AWG (41/36) tinned copper with 105°C PVC insulation

**Rating:** Hands free testing at 300 VRMS, 5 Amps

## BNC Female Breakout to Stackable Single Banana Plugs

Model# BU-5220-A-4-0

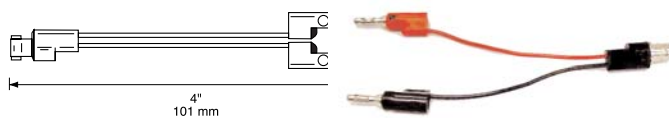

**Material:** *BNC Female Connector:* quality tarnish-resistant, plated brass with a gold-plated brass center contact, ABS housing; *Banana Plug:* premium nine-leaf, nickel-plated beryllium copper springs and copper alloy 360 bodies for minimum stacked in multiples, ABS housing; *Hook-up Wire:* #20 AWG (41/36) tinned copper with 105°C PVC insulation

**Rating:** Hands free testing at 300 VRMS, 10 Amps

## Mini-Micro-Plunger to BNC Male

Model# BU-1450-C-\*\*-0

**Material:** *BNC Male Connector:* MIL-C-39012, gold-plated center contact and silver-plated body; *Coaxial Cable:* shielded RG58C/U, MIL-C-17F, 50 ohm; *Plunger:* nylon housing, stainless steel spring and beryllium copper contact

**\*\*Length:** -12" (.3m), 24" (.6m), 36" (.9m), 48" (1.2m), 60" (1.5m)

**Rating:** Hands free testing at 300 VRMS on center conductor





Mueller DMM kits are designed for compatibility with Fluke, Agilent, Tektronix, and other DMM manufacturers. Reference page 28 for a Meter-Mate™ meter-to-accessory cross-reference table.



Order Key					
<b>BU-0000-X-00-*</b>					
Typical Mueller Part #		Type of wire		Color Length in inches	
Color Key			Available Test Lead Lengths		
0=Black	4=Yellow	6=Blue	6"	24"	48"
2=Red	5=Green	9=White	12"	36"	60"

## 400002 (34000 Series Bench DMM Meter Mate Kit)

34000 Series Bench DMM's Meter Mate Kit has compatible replacement leads for all Agilent 34000 Series digital multimeters.

QTY	P/N	DESCRIPTION
1	PM-50000	Blue tri-fold bag
1	Box 3	Retail Packaging Box
1	PM-1000	Compatibility Label
1	BU-6162-M-60-0	TL, banana-to-right angle banana, silicone, 60", 1kV, 20 Amp, black
1	BU-6162-M-60-2	TL, banana-to-right angle banana, silicone, 60", 1kV, 20 Amp, red
1	BU-26106-0	Test Probe, banana, 1kV, 20 Amp, black
1	BU-26106-2	Test Probe, banana, 1kV, 20 Amp, red
1	BU-65-0	Clip, insulated, banana, 1kV, 30 Amp, black
1	BU-65-2	Clip, insulated, banana, 1kV, 30 Amp, red
1	BU-20431-0	Insulated plunger hook, mini grip, 1kV, 3 Amp, black
1	BU-20431-2	Insulated plunger hook, mini grip, 1kV, 3 Amp, red
1	BU-00207-0	Threaded plunger, 1kV, 15 Amps, black
1	BU-00207-2	Threaded plunger, 1kV, 15 Amps, red
1	BU-26130-0	Ultra Tech Test Prod, 1kV, 15 Amp, black
1	BU-26130-2	Ultra Tech Test Prod, 1kV, 15 Amp, red
1	BU-30212-0	Insulated spade lug, black
1	BU-30212-2	Insulated spade lug, red
1	BU-32101-0	Banana Adapter, 1kV, 15 Amp, black
1	BU-32101-2	Banana Adapter, 1kV, 15 Amp, red



### 400003 (Fluke Replacement Electrical DMM Meter Mate Kit)

Electrical DMM Test Lead Kit offers a complete assortment of modular test leads and probes compatible with all Fluke DMMs.

QTY	P/N	Description
1	PM-1015	Poly Bag 6.5z11.5, Vinyl
1	Box 4	Retail Packaging Box
1	PM-1000	Compatibility Label
1	BU-6162-M-48-0	TL, banana-to-right angle banana, silicone, 48", black
1	BU-6162-M-48-2	TL, banana-to-right angle banana, silicone, 48", red
1	BU-26103-0	Test Probe, banana, 1000V, IEC Cat III, black
1	BU-26103-2	Test Probe, banana, 1000V, IEC Cat III, red
1	BU-656-2	Safety Clip, insulated, banana, red
1	BU-20434-0	Insulated plunger jaw clip, black
1	BU-20434-2	Insulated plunger jaw clip, red
1	BU-20431-0	Insulated plunger hook, mini grip, black
1	BU-20431-2	Insulated plunger hook, mini grip, red
1	BU-30212-0	Insulated spade lug, black
1	BU-30212-2	Insulated spade lug, red
1	BU-32101-0	Banana Adapter, 1kV, 15 Amp, black
1	BU-32101-2	Banana Adapter, 1kV, 15 Amp, red

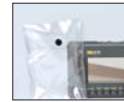

### 400000 (Fluke Replacement Industrial/Automotive DMM Meter Mate Kit)

Automotive/Industrial DMM Test Lead Kit offers modular test probes and leads compatible with all Fluke DMMs.

QTY	P/N	Description
1	PM-50000	Blue tri-fold bag
1	Box 1	Retail Packaging Box
1	PM-1000	Compatibility Label
1	BU-6162-M-39-0	TL, banana-to-right angle banana, silicone, 39", 1kV, 20 Amp, black
1	BU-6162-M-39-2	TL, banana-to-right angle banana, silicone, 39", 1kV, 20 Amp, red
1	BU-26103-0	Test Probe, banana, 1kV, IEC Cat III, black
1	BU-26103-2	Test Probe, banana, 1kV, IEC Cat III, red
1	BU-65-0	Clip, insulated, banana, 1kV, 30 Amp black
1	BU-65-2	Clip, insulated, banana, 1kV, 30 Amp red
1	BU-20433-0	Insulated plunger, mini grip, 1kV, 1 Amp, black
1	BU-20433-2	Insulated plunger, mini grip, 1kV, 1 Amp, red
1	JP-491-0	Back probe, small, 20 Amp, black
1	JP-491-2	Back probe, small, 20 Amp, red
1	JP-591-0	Back probe, large, 20 Amp, black
1	JP-591-2	Back probe, large, 20 Amp, red
1	JP-8078-J-C0	Insulation piercing clip with black boot
1	JP-8078-J-C2	Insulation piercing clip with red boot



**KT-MS002 (Deluxe Micro-scale Test Kit)**  
**KT-MS001 (Deluxe Micro-scale Test Kit, accessories only)**

Micro-scale Test Kit accessories are designed to attach to industry standard multimeter test probes or prods. These accessories allow convenient and safe testing on breadboards or printed circuit boards.

QTY	P/N	Description
2	BU-2241-D-48-*	TL, multi-feature test prod to right angle shrouded banana, 48", 1 red, 1 black
2	MS200-*	Breadboard Pin, 1 red, 1 black
2	MS201-*	Needle pin, 1 red, 1 black
2	MS202-*	Alligator Clip, 1 red, 1 black
2	MS203-*	Micro-plunger Clip, 1 red, 1 black
1	MS204	Battery Current Probe
2	MS205-*	Pin Socket, 1 red, 1 black
2	MS206-*	Magnetic Probe, 1 red, 1 black
2	MS208-*	Nano-plunger Clip, 1 red, 1 black
1	MS207	Carrying Pouch



**KT-MS004 (Basic Micro-scale Test Kit)**  
**KT-MS003 (Basic Micro-scale Test Kit, accessories only)**

KT-MS003 includes all of the above accessories without the 48" test leads.

QTY	P/N	Description
2	BU-2241-D-48-*	TL, multi-feature test prod to right angle shrouded banana, 48", 1 red, 1 black
2	MS201-*	Needle Pin, 1 red, 1 black
2	MS202-*	Alligator Clip, 1 red, 1 black
2	MS203-*	Micro-plunger Clip, 1 red, 1 black
2	MS208-*	Nano-plunger Clip, 1 red, 1 black
2	MS200-*	Breadboard Pin, 1 red, 1 black
2	MS205-*	Pin Socket, 1 red, 1 black
1	MS207	Carrying pouch

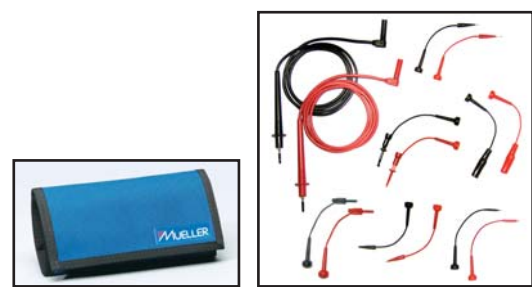

Mueller Test Lead	Manufacturer & Meter Model	Mueller Test Lead	Manufacturer & Meter Model	Mueller Test Lead	Manufacturer & Meter Model
<b>ALFA ELECTRONICS</b>		<b>BECKMAN</b>		<b>ECG</b>	
400000 400002 400003 BU-2241-D-48-* BU-4062-M-39-* BU-6162-M-39-* KT-MS002	DMM-175A, DMM-2360, LCR-195, LCR-814, 7705	400000 400002 400003 BU-4061-M-39-* BU-6161-M-39-* KT-MS002	TECH-300, TECH-310, 310B, 310UL, 310T, 320, 320B, 330, 350, 360, 3000, 3010, 3010B, 3020, 3020UL, 3030, 3050, 4410, DM40, DM45, HD100, HD11, HD110T, HD130	400000 400002 400003 BU-2241-D-48-* BU-4062-M-39-* BU-6162-M-39-* KT-MS002	AM-20, FET-43, DM-74, DM-76, DM-300, DM-310, DM-410, DM-78, DM-305
<b>A.W. SPERRY</b>		BU-2241-D-48-* BU-4062-M-39-* BU-6162-M-39-*	HD151, HD152, HD153, 222, 223, RMS225	<b>ELENCO</b>	
400000 400002 400003 BU-2641-D-48-* KT-MS002	DP-300, DP-306, DP-310, DP-316, EZ-6100, EZ-6110, EZ- 6200, EZ-6220, SP-160, SP-170, SP-250, SP-1000F	BU-2741-D-48-*	DM15, DM20, DM25, DM77, TECH-300, TECH-310, 310UL, 320B, 330, 800, 850, DL243A, 3000, 3010, 3010B, 3010UL, 3020, 3020B, 3020U; 3030 (BEFORE 8/1/83)	400000 400002 400003 BU-2741-D-48-* KT-MS002	M-1400, CM-1500A, CM-1550, M-1600, M-1650, M-5000
BU-4061-M-39-* BU-6161-M-39-*	DM-3010	BU-2241-D-48-* BU-4062-M-39-* BU-6162-M-39-*	DMSLX, DM10XL, DM15XL	BU-4061-M-39-* BU-6161-M-39-*	M-3500, M-4500
<b>AMERICAN RELIANCE INC.</b>		BU-2241-D-48-* BU-4062-M-39-* BU-6162-M-39-* KT-MS002	AM201	BU-2241-D-48-* BU-4062-M-39-* BU-6162-M-39-*	LC-1800, M-2600, M-2650, M-2661, M-2671, M-2680, M-2690, M-7000
400000 400002 400003 BU-2741-D-48-* BU-4061-M-39-* BU-6161-M-39-* KT-MS002	AR-120, AR-140, AR-130A/B, AR- 160H, AR-170NL, AR-180T, AR230S, AR-260CP, AR- 280CA, AR-690LP, AR-270NL, AR-700T	BU-2741-D-48-* KT-MS002	<b>Bel MERIT</b>	<b>EMCO</b>	
BU-2241-D-48-* BU-4062-M-39-* BU-6162-M-39-*	AR-3200	400000 400002 400003 BU-2741-D-48-* KT-MS002	AA300, DM20S, DM30S, DM3000, DM3050, DM3100, DM3200, DM4100, DM4700, DM5050C, DM5100	400000 400002 400003 BU-2241-D-48-* BU-4062-M-39-* BU-6162-M-39-* KT-MS002	ACM-3A, DCM-1A, DM-3650B, DMR- 26, FD-81T, FD-91T, FD-95AR, FD-100TC, FDA-50
<b>AMPROBE</b>		BU-2241-D-48-* BU-4062-M-39-* BU-6162-M-39-*	<b>BIDDLE</b>	BU-2741-D-48-*	F-72, MT-2
400000 400002 400003 BU-2741-D-48-* KT-MS002	AM-1A, AM-2A, AM-2B, AM2DP, BDP, AM-3B, AM-5, AM-6	400000 400002 400003 BU-2741-D-48-* KT-MS002	10, DA116B, DA117	<b>EXTECH</b>	
BU-4061-M-39-* BU-6161-M-39-*	AM-4B, AM-6A	BU-2241-D-48-* BU-4062-M-39-* BU-6162-M-39-*	<b>CAIRAD</b>	400000 400002 400003 BU-2241-D-48-* BU-4062-M-39-* BU-6162-M-39-* KT-MS002	D380196, D380198, D380285, D380501, D380487, D380602
BU-2241-D-48-* BU-4062-M-39-* BU-6162-M-39-*	ACD-10, ACD-11, AM-1E, AM-2E, AM-2EDP, AM-3E, AM- 1200, AM-1250, AM-1260, AM- 1280, AM-4A, AM-2BB, AM- 2BBDP, AM-4	BU-2241-D-48-* BU-4062-M-39-* BU-6162-M-39-*	65-267	BU-2741-D-48-*	D38091, D380165, D380166, D380168, D380652
<b>ARISTA</b>		BU-2641-D-48-* KT-MS002	<b>DATA PRECISION</b>	BU-2641-D-48-*	D380900, D380910, D380911, D380913
400000 400002 400003 BU-2641-D-48-* KT-MS002	70-459, 70-463, 70-480, 70-485, 70-490	BU-2741-D-48-*	935, 936, 938, 945, 1350, 1351, 2480(R), 2590(R), 3400(A), 3500, 3600, 7500, 8100, 8200	BU-4061-M-39-* BU-6161-M-39-*	D380925, D380950 D380925, D380950
<b>B &amp; K PRECISION</b>		BU-2241-D-48-* BU-4062-M-39-* BU-6162-M-39-*	<b>DATA TECH</b>	BU-2741-D-48-*	D380960
400000 400002 400003 BU-2641-D-48-* KT-MS002	114, 214, 227, 283, 290, 530, 810A, 820, 830, 2801, 2805, 2830, 2831, 2831A	BU-2241-D-48-* BU-4062-M-39-* BU-6162-M-39-*	20, 30A, 30LC, 30R, 31, 45	BU-2241-D-48-* BU-4062-M-39-* BU-6162-M-39-*	D381909
BU-4061-M-39-* BU-6161-M-39-*	340A, 350, 2608, 2807, 2816, 2817, 2818, 2820, 2832, 2833, 2834, 2845, LA1000	BU-2741-D-48-*			
BU-2741-D-48-*	111, 114, 116, 117, 214, 2703, 2704, 2800, 2810, 2815, 815, 875A, 878				
BU-2241-D-48-* BU-4062-M-39-* BU-6162-M-39-*	388-HD, 810A, 875A, 2911, 2912, 2940, 2945, 2960, 2860				

# Test Lead to Meter Cross Reference

## Mueller Test Lead Manufacturer & Meter Model

Mueller Test Lead	Manufacturer & Meter Model
400000 400002 400003 BU-4061-M-39-* BU-6161-M-39-* KT-MS002	<b>FLUKE</b>  D800, D802, D804, 8020A, 8020B, 8021B, 8022A, 8022B, 8024A, 8024B, 8026B, 8050A
BU-2641-D-48-*	334, D810, D811, 8000A, 8010A, 8012A, 8030A, 8040A, 8125A, 8200A, 8291A, 8300A, 8375A, 8400A, 8500A, 8502A, 8520A, 8522A, 8600A, 8800A, 8810A
BU-2241-D-48-* BU-4062-M-39-* BU-6162-M-39-*	10, 11, 12, 21-II, 23-II, 25, 27, 29-II, 37, 45, 70-II, 73-II, 75-II, 76, 77-II, 79-II, 83, 85, 87, 863, 865, 8060A, 8062A
400000 400002 400003 BU-4061-M-39-* BU-6161-M-39-* KT-MS002	<b>FOTEC</b>  M-100, M-110
400000 400002 400003 BU-2641-D-48-* KT-MS002	<b>G. C. ELECTRONICS</b>  20-200, 20-207, 20-210
400000 400002 400003 BU-2241-D-48-* BU-4062-M-39-* KT-MS002	<b>GOLDSTAR</b>  DM-6335, DM-7143, DM-7333, DM-8135, DM-8243, DM-8433, DM-9183
BU-6162-M-39-*	DM-6335, DM-7143, DM-7333, DM-8135, DM-8243, DM-8433, DM-9183
BU-2241-D-48-0* BU-4062-M-39-* BU-6162-M-39-*	65-260, 65-261, 65-264, 65-265
BU-2031-A-00-*	DM-9055S
400000 400002 400003 BU-2641-D-48-* KT-MS002	<b>HEWLETT PACKARD</b>  3468A
BU-2241-D-48-* BU-4062-M-39-* BU-6162-M-39-*	HP-970, HP-971A, HP-972A, HP-973A, HP-974A, HPE2373A, HPE2377A, HPE2378A
400000 400002 400003 BU-2641-D-48-* KT-MS002	<b>HICKOCK</b>  LX303, LX304, LX306
BU-4061-M-39-* BU-6161-M-39-*	MX331, MX333

## Mueller Test Lead Manufacturer & Meter Model

Mueller Test Lead	Manufacturer & Meter Model
400000 400002 400003 BU-2741-D-48-* KT-MS002	<b>HIOKI</b>  3011, 3212
BU-2241-D-48-* BU-4062-M-39-* BU-6162-M-39-*	M-7000, LC-1800
400000 400002 400003 BU-2241-D-48-* BU-4062-M-39-* BU-6162-M-39-* KT-MS002	<b>HITACHI</b>  VR-3510, VR-3525, VR-3550
400000 400002 400003 BU-2241-D-48-* BU-4062-M-39-* BU-6162-M-39-* KT-MS002	<b>INSTEK</b>  DM-351, BM-352, DM-391, DM-392, DM-393
400000 400002 400003 BU-2641-D-48-* KT-MS002	<b>ITT METRIX</b>  MX-522, MX-562, MX-563, MX-575
400000 400002 400003 BU-4061-M-39-* BU-6161-M-39-* KT-MS002	<b>KEITHLEY</b>  128, 130, 130A, 131, 132C, 132F, 135, 135A, 169, 176, 177, 179A, 181, 191, 192, 195
400000 400002 400003 BU-2241-D-48-* BU-4062-M-39-* BU-6162-M-39-* KT-MS002	<b>KELVIN</b>  92, 93, 94, 95, 100, 150, 200, PRO-400
400000 400002 400003 BU-2641-D-48-* KT-MS002	<b>KINGDOM (KDE)</b>  ETC-2000, ETC-2050, ETC-5000T, ETU-200, ETU-202, ETU-500, ETU-2050, ETU-3000, ETU-5000, ETU-5001, KD-25C, KD-30C, KD-55C, KD-300, KD-305, KD-600, KD-605, KD-615
BU-2241-D-48-* BU-4062-M-39-* BU-6162-M-39-*	KD-508

## Mueller Test Lead Manufacturer & Meter Model

Mueller Test Lead	Manufacturer & Meter Model
400000 400002 400003 BU-2241-D-48-* BU-4062-M-39-* BU-6162-M-39-* KT-MS002	<b>MERCER</b>  9301, 9340, 9370, 9401, 9670
400000 400002 400003 BU-2241-D-48-* BU-4062-M-39-* BU-6162-M-39-* KT-MS002	<b>METEX</b>  M80, M3610, M3610B, M3620, M3630B, M3630CR, M3650, M3650B, 3650CR, M3800, M3900TD, M4600, M4630, M4630B, M4630CR, M4650, M4650B, M4650CR
BU-2641-D-48-*	M200, M300, M400, M500, GL-20
400000 400002 400003 BU-2241-D-48-* BU-4062-M-39-* BU-6162-M-39-* BU-4061-M-39-* BU-6161-M-39-* KT-MS002	<b>MITCHELL</b>  DSA2003, 3104
BU-2741-D-48-*	DC801, FT303TR, FT602B, TCYF1075, TC4055, 1800A
BU-4061-M-39-* BU-6161-M-39-*	TCMIT166
BU-4061-M-39-* BU-6161-M-39-*	YF1030C, YF3000, 7905A
400000 400002 400003 BU-2641-D-48-* KT-MS002	<b>MODUTEC</b>  ACT-25, ACT-30, ACT-50, ACT-100, BT-22, CT-300, CT-600, CT-1200, MO-20KT, MO-2K
400000 400002 400003 BU-2641-D-48-* KT-MS002	<b>NON-LINEAR SYSTEMS</b>  TT-20
400000 400002 400003 BU-2641-D-48-* KT-MS002	<b>NORTH AMERICAN SOAR</b>  3025, 3030, 3050, 5025, 5030
BU-2641-D-48-*	8010, 8025, 8050, 8090, TC-202, ME-530, ME-540, ME-550, SX-220





# Packaged Parts

Mueller's packaged product feature attractive point-of-purchase cards with related cross-selling product references. Mueller has assembled the most popular selling product in a comprehensive package program utilizing (UPC) bar code standards. Our package cards are designed to reduce retail real estate requirements.

Packaged Part #	Bulk Part #	Packaged Part #	Bulk Part #	Packaged Part #	Bulk Part #	Packaged Part #	Bulk Part #
010000	(1) BU-21APN, (1) BU-21APS, (1) BU-23-0, (1) BU-23-2	080015	(1) BU-1414-E-36-2	080082	(1) BU-1111-A-48-2	100009	(1) BU-4162-M-48-0, (1) BU-4162-N-48-2
010001	(1) BU-24APS, (1) BU-24APN, (1) BU-26-0, (1) BU-26-2	080016	(1) BU-1420-A-36-0	080083	(1) BU-1111-A-60-2	100010	(1) BU-4162-N-48-0, (1) BU-4162-N-48-2
010002	(1) BU-75K	080017	(1) BU-1420-A-36-2	080084	(1) BU-1111-A-60-2	110000	(1) BU-2841-D-48-*, (2) BU-60TBO, (2) BU-62-*, (2) BU-00230-*, (2) BU-00225-*, (2) BU-00207-*
010003	(2) BU-27, (1) BU-29-0, (1) BU-29-2	080018	(1) BU-2020-A-36-0	080085	(1) BU-1120-A-12-0	110001	(2) BU-4641-D-48-*, (2) BU-62-*, (2) BU-60TBO, (2) BU-00230-*, (2) BU-00225-*, (2) BU-00207-*
010004	(4) BU-30, (2) BU-32-0, (2) BU-32-2	080019	(1) BU-2020-A-36-2	080086	(1) BU-1120-A-12-2	110002	(2) BU-6441-D-48-*, (2) BU-62-*, (2) BU-60TBO, (1) BU-1149-A-12-0, (2) BU-00225-*, (2) BU-00207-*
010005	(4) BU-30C, (2) BU-32-0, (2) BU-32-2	080020	(1) BU-2030-A-36-0	080087	(1) BU-1120-A-24-0	110003	(2) BU-2741-D-48-*, (2) BU-62-*, (2) BU-60TBO, (2) BU-00230-*, (2) BU-00225-*, (2) BU-00207-*
010006	(4) BU-34, (2) BU-36-0, (2) BU-36-2	080021	(1) BU-2030-A-36-2	080088	(1) BU-1120-A-24-2	110004	(2) BU-2241-D-48-*, (2) BU-62-*, (2) BU-60TBO, (2) BU-00230-*, (2) BU-00225-*, (2) BU-00207-*
010007	(4) BU-34C, (2) BU-36-0, (2) BU-36-2	080022	(1) BU-2031-A-36-0	080089	(1) BU-1120-A-48-0	110005	(2) BU-2641-D-48-*, (2) BU-62-*, (2) BU-60TBO, (2) BU-00230-*, (2) BU-00225-*, (2) BU-00207-*
010008	(4) BU-45, (2) BU-47-0, (2) BU-47-2	080023	(1) BU-2031-A-36-2	080090	(1) BU-1120-A-48-2	110006	(2) BU-2141-D-48-*, (2) BU-62-*, (2) BU-60TBO, (2) BU-00230-*, (2) BU-00225-*, (2) BU-00207-*
010009	(2) BU-48B, (1) BU-49-0, (1) BU-49-2	080024	(1) BU-2929-M-10-0	080091	(1) BU-1120-A-60-0	110007	(1) BU-2141-D-48-0, (1) BU-2143-D-48-0, (1) BU-2143-D-48-2
010010	(2) BU-50C, (1) BU-49-0, (1) BU-49-2	080025	(1) BU-2929-M-10-2	080092	(1) BU-1120-A-60-2	110008	(1) BU-2143-D-48-0, (1) BU-2143-D-48-2
010011	(2) BU-60CHS-0, (2) BU-60CHS-2	080026	(1) BU-2929-M-20-0	080093	(1) BU-1149-A-12-0	110009	(1) BU-2241-D-48-0, (1) BU-2241-D-48-2
010012	(4) BU-60CS, (2) BU-62-0, (2) BU-62-2	080027	(1) BU-2929-M-20-2	080094	(1) BU-1149-A-12-2	110010	(1) BU-2243-D-48-0, (1) BU-2243-D-48-2
010013	(2) BU-60HS-0, (2) BU-60HS-2	080028	(1) BU-2929-M-39-0	080095	(1) BU-1149-A-24-0	110011	(1) BU-2641-D-48-0, (1) BU-2641-D-48-2
010014	(4) BU-60S, (2) BU-62-0, (2) BU-62-2	080029	(1) BU-2929-M-39-2	080096	(1) BU-1149-A-24-2	110012	(1) BU-2643-D-48-0, (1) BU-2643-D-48-2
010015	(4) BU-85, (2) BU-87-0, (2) BU-87-2	080030	(1) BU-3030-A-36-0	080097	(1) BU-1149-A-48-0	110013	(1) BU-2741-D-48-0, (1) BU-2741-D-48-2
010016	(2) BU-63-0, (2) BU-63-2	080031	(1) BU-3030-A-36-2	080098	(1) BU-1149-A-48-2	110014	(1) BU-2743-D-48-0, (1) BU-2743-D-48-2
010017	(10) BU-30	080032	(1) BU-3070-C-36-0	080099	(1) BU-1149-A-60-0	110015	(1) BU-2841-D-48-0, (1) BU-2841-D-48-2
010018	(10) BU-30C	080033	(1) BU-3131-A-36-0	080100	(1) BU-1149-A-60-2	110016	(1) BU-4641-D-48-0, (1) BU-4641-D-48-2
010019	(10) BU-34	080034	(1) BU-3131-A-36-2	080101	(1) BU-1414-E-12-0	110017	(1) BU-6441-D-48-0, (1) BU-6441-D-48-2
010020	(10) BU-34C	080035	(1) BU-5030-C-36-0	080102	(1) BU-1414-E-12-2	110018	(2) BU-60TBO, (1) BU-4062-M-39-0, (1) BU-4062-M-39-2, (1) BU-62-0, (1) BU-62-2
010021	(6) BU-45	080036	(1) BU-5031-C-36-0	080103	(1) BU-1414-E-48-0	110019	(1) BU-26101-0, (1) BU-26101-2, (1) BU-6162-M-39-0, (1) BU-65-0, (1) BU-65-2
010022	(6) BU-48B	080037	(1) BU-5050-B-36-0	080104	(1) BU-1414-E-48-2	110020	(1) BU-26130-0, (1) BU-26130-2, (1) BU-6162-M-39-0, (1) BU-6162-M-39-2
010023	(6) BU-55	080038	(1) BU-5070-B-36-0	080105	(1) BU-1420-A-12-0	150000	(4) BU-00232
010024	(6) BU-60CS	080039	(1) BU-5656-B-36-0	080106	(1) BU-1420-A-12-2	150001	(2) BU-00233-0, (2) BU-00233-2
010025	(6) BU-60S	080040	(1) BU-7070-B-36-0	080107	(1) BU-1450-C-12-0	150002	(4) BU-00241
010026	(6) BU-70S	080041	(1) BU-8080-E-12-0	080108	(1) BU-2020-A-48-0	150003	(4) BU-00242
010027	(6) BU-85	080042	(1) BU-8080-E-12-2	080109	(1) BU-2020-A-48-2	150004	(2) BU-00243-0, (2) BU-00243-2
010028	(1) BU-21APN, (1) BU-21APS	080043	(1) BU-1449-E-36-0, (1) BU-1449-E-36-2	080110	(1) BU-2020-A-60-0	150005	(2) BU-00244-0, (2) BU-00244-2
010029	(1) BU-24APN, (1) BU-24APS	080044	(1) BU-1080-E-12-0	080111	(1) BU-2020-A-60-2	150006	(2) BU-00245-0, (2) BU-00245-2
010030	(4) BU-27	080045	(1) BU-1080-E-12-2	080112	(1) BU-3030-A-12-0	150007	(2) BU-00246-0, (2) BU-00246-2
010031	(1) BU-41A-0, (1) BU-41A-2	080046	(1) BU-1421-A-36-0	080113	(1) BU-3030-A-12-2	150008	(1) BU-00247-0
010032	(1) BU-46A-0, (1) BU-46A-2	080047	(1) BU-1421-A-36-2	080114	(1) BU-3030-A-48-0	150009	(1) BU-00260
010033	(1) BU-65-0, (1) BU-65-2	080048	(1) BU-1170-F-36-0	080115	(1) BU-3030-A-48-2	150010	(1) BU-00262-0
010034	(4) BU-30TBO	080049	(1) BU-1153-F-36-0	080116	(1) BU-7070-B-12-0	150011	(1) BU-00283
010035	(4) BU-60TBO	080050	(1) BU-1156-C-36-0	080117	(1) BU-7070-B-12-2		
010036	(4) BU-30TBO, (2) BU-31-0, (2) BU-31-2	080051	(1) BU-1450-C-36-0	080118	(1) BU-7070-B-24-2		
010037	(4) BU-60TBO, (2) BU-62-0, (2) BU-62-2	080052	(1) BU-1456-C-36-0	080119	(1) BU-00285		
010038	(2) BU-27, (2) BU-48B, (1) BU-29-0, (1) BU-29-2, (1) BU-49-0, (1) BU-49-2	080053	(1) BU-1480-E-12-0	080120	(1) BU-00286		
010039	(2) BU-27C, (2) BU-48C, (1) BU-29-0, (1) BU-29-2, (1) BU-49-0, (1) BU-49-2	080054	(1) BU-1480-E-12-2	080121	(1) BU-00287		
010040	(2) BU-30, (2) BU-70, (1) BU-32-0, (1) BU-32-2, (1) BU-72-0, (1) BU-72-2	080055	(1) BU-1481-E-12-0	090000	(1) M08SW		
010041	(2) BU-30C, (2) BU-70C, (1) BU-32-0, (1) BU-32-2, (1) BU-72-0, (1) BU-72-2	080056	(1) BU-1481-E-12-2	090001	(1) M10X1		
010042	(2) BU-60S, (2) BU-48B, (2) BU-27, (2) BU-24APN	080057	(1) BU-5330-F-36-0	090002	(1) M10X10		
010043	(2) BU-61, (1) BU-62-0, (1) BU-62-2	080058	(1) BU-3056-C-36-0	090003	(1) M10SW		
080000	(1) BU-1010-A-36-0	080059	(1) BU-5331-F-36-0	090004	(1) M10X100		
080001	(1) BU-1010-A-36-2	080060	(1) BU-3156-C-36-0	090005	(1) M12X100		
080002	(1) BU-1031-A-36-0	080061	(1) BU-3180-E-12-0	090006	(1) M14X10		
080003	(1) BU-1031-A-36-2	080062	(1) BU-3180-E-12-2	090007	(1) M12X1		
080004	(1) BU-1111-A-36-0	080063	(1) BU-4444-A-36-0	090008	(1) M12X10		
080005	(1) BU-1111-A-36-2	080064	(1) BU-4444-A-36-2	090009	(1) M12SW		
080006	(1) BU-1120-A-36-0	080065	(1) BU-3070-F-36-0	100000	(1) BU-6161-M-39-0, (1) BU-6161-M-39-2		
080007	(1) BU-1120-A-36-2	080066	(1) BU-5100-A-4-0	100001	(1) BU-6161-N-39-0, (1) BU-6161-N-39-2		
080008	(1) BU-1121-A-36-0	080067	(1) BU-5114-A-4-0	100002	(1) BU-6162-M-39-0, (1) BU-6162-M-39-2		
080009	(1) BU-1121-A-36-2	080068	(1) BU-5120-A-4-0	100003	(1) BU-6162-N-39-0, (1) BU-6162-N-39-2		
080010	(1) BU-1149-A-36-0	080069	(1) BU-5131-A-4-0	100004	(1) BU-6162-N-39-0, (1) BU-6162-N-39-2		
080011	(1) BU-1149-A-36-2	080070	(1) BU-5144-A-4-0	100005	(1) BU-4061-M-39-0, (1) BU-4061-M-39-2		
080012	(1) BU-1150-C-36-0	080071	(1) BU-5200-A-4-0	100006	(1) BU-4061-N-39-0, (1) BU-4061-N-39-2		
080013	(1) BU-1170-C-36-0	080072	(1) BU-5214-A-4-0	100007	(1) BU-4062-N-39-0, (1) BU-4062-N-39-2		
080014	(1) BU-1414-E-36-0	080073	(1) BU-5220-A-4-0	100008	(1) BU-4062-M-39-0, (1) BU-4062-M-39-2		
		080074	(1) BU-5231-A-4-0	100009	(1) BU-6262-M-39-0, (1) BU-6262-M-39-2		
		080075	(1) BU-5244-A-4-0				
		080076	(1) BU-5659-B-36-0				
		080077	(1) BU-1111-A-12-0				
		080078	(1) BU-1111-A-12-2				
		080079	(1) BU-1111-A-24-0				
		080080	(1) BU-1111-A-24-2				
		080081	(1) BU-1111-A-48-0				

Packaged Part #	Bulk Part #	Packaged Part #	Bulk Part #	Packaged Part #	Bulk Part #	Packaged Part #	Bulk Part #
150012	(1) BU-00261	150026	(1) BU-31605-0, (1) BU-31605-2	150040	(1) BU-20434-0		(2) BU-00230-*, (2) BU-00225-*, (2) BU-00207-*
150013	(1) BU-00281-0, (1) BU-00281-2	150027	(1) BU-31606-0, (1) BU-31606-2	150041	(1) BU-20434-2	180000	(10 FT) WI-M-18-0
150014	(1) BU-00282-0, (1) BU-00282-2	150028	(1) BU-32101-0, (1) BU-32101-2	150042	(1) BU-26101-0, (1) BU-26101-2	180001	(10 FT) WI-M-18-2
150015	(1) BU-00201-0, (1) BU-00201-2	150029	(2) BU-00248-0, (2) BU-00248-2	150043	(1) BU-26106-0, (1) BU-26106-2	180002	(10 FT) WI-M-20-0
150016	(1) BU-00202-0, (1) BU-00202-2	150030	(1) BU-00284-0, (1) BU-00284-2	150044	(1) BU-32601-0, (1) BU-32601-2	180003	(10 FT) WI-M-20-2
150017	(1) BU-00203-0, (1) BU-00203-2	150031	(1) BU-00263-0	150045	(2) BU-15-0	180004	(10 FT) WI-M-22-0
150018	(2) BU-00208-0, (2) BU-00208-2	150032	(2) BU-00234-0, (2) BU-00234-2	150046	(2) BU-15-2	180005	(10 FT) WI-M-22-2
150019	(1) BU-31101-0	150033	(1) BU-26130-0, (1) BU-26130-2	150047	(1) JP-29491-2, (1) JP-29591-2	400000	Automotive Kit
150020	(1) BU-31101-2	150034	(1) BU-20431-0	150048	(2) BU-31103-0	400002	Electrical Kit
150021	(1) BU-31102-0	150035	(1) BU-20431-2	150049	(2) BU-31103-2	400003	Electronic Kit
150022	(1) BU-31102-2	150036	(1) BU-20432-0	150050	(4) BU-16-0		
150023	(1) BU-31602-0, (1) BU-31602-2	150037	(1) BU-20432-2	150051	(4) BU-16-2		
150024	(1) BU-31603-0, (1) BU-31603-2	150038	(1) BU-20433-0	150052	(1) BU-00247-2		
150025	(1) BU-31604-0, (1) BU-31604-2	150039	(1) BU-20433-2	150053	(2) BU-60TBO, (2) BU-62-*,		

## Mueller Clip/Insulator Reference Chart

CLIP NUMBER	AMPS	WIRE ATTACHMENT	JAW OPENING	USE WITH INSULATOR	WIRE AWG	PLATING
BU-102B-*	300	Lug	6 1/2"	insulated	Up to 0	Copper
BU-102BK-*	300	Lug	6 1/2"	insulated	Up to 0	Copper
BU-102W-*	400	Lug	6 1/2"	insulated	Up to 0	Copper
BU-11APN/WPS	100	Lug	1 5/8"	13	Up to 3/0	Zinc
BU-11CPN/CPS	200	Lug	1 5/8"	13	Up to 3/0	Solid Copper
BU-21APN/APS	50	Crimp/Screw	1 1/16"	23	Up to 8	Zinc
BU-21CPN/CPS	100	Lug	1 1/16"	23	Up to 8	Solid Copper
BU-24APN/WPS	25	Crimp/Screw	3/4"	26	Up to 10	Zinc
BU-25	40	Crimp/Screw	3/4"	26	Up to 10	Zinc
BU-25C	75	Crimp/Screw	3/4"	26	Up to 10	Solid Copper
BU-27	20	Crimp/Screw	5/8"	29/90	Up to 12	Zinc
BU-27C	40	Crimp/Screw	5/8"	29/90	Up to 12	Solid Copper
BU-27CG	40	Crimp/Screw	5/8"	29/90	Up to 12	Solid Copper
BU-27CGW	40	Crimp/Screw	5/8"	29/90	Up to 12	Solid Copper
BU-30	5	Crimp/Solder	3/16"	32	20-24	Nickel
BU-30BL	5	Crimp/Solder	3/16"	31	18-24	Nickel
BU-30C	5	Crimp/Solder	3/16"	32	20-24	Solid Copper
BU-30TBO	5	Threaded	3/16"	31	NA	Nickel
BU-33C	300	Lug	1 13/16"	35	Up to 300MCM	Solid Copper
BU-34	5	Crimp/Solder	7/32"	36	20-24	Nickel
BU-34C	5	Crimp/Solder	7/32"	36	20-24	Copper
BU-40A-*	15	Crimp/Solder	3/4"	insulated	Up to 12	Nickel
BU-40C-*	20	Crimp/Solder	3/4"	insulated	Up to 12	Copper
BU-41A-*	200	Crimp/Solder	1 9/16"	insulated	Up to 1	Copper
BU-41C-*	400	Crimp/Solder	1 9/16"	insulated	Up to 1	Solid Copper
BU-45	5	Crimp/Screw	5/16"	47	16-22	Zinc
BU-45C	10	Crimp/Screw	5/16"	47	16-22	Solid Copper
BU-46A-*	50	Crimp/Solder	1 1/8"	insulated	Up to 10	Copper
BU-46C-*	75	Crimp/Solder	1 1/8"	insulated	Up to 10	Solid Copper
BU-48B	10	Crimp/Screw	1/2"	49	14-20	Zinc
BU-48B2E	10	Crimp	1/2"	49	14-20	Zinc
BU-48C	20	Crimp/Screw	1/2"	49	14-20	Solid Copper
BU-50C	20	Crimp/Screw	1/2"	49	14-18	Solid Copper
BU-51C	20	Crimp/Screw	1/2"	49	14-18	Solid Copper
BU-55	10	Crimp/Screw	7/16"	49	14-20	Zinc
BU-60	10	Crimp/Solder/Plug-on	5/16"	62	14-20	Nickel
BU-60C	10	Crimp/Solder/Plug-on	5/16"	62	14-20	Solid Copper

CLIP NUMBER	AMPS	WIRE ATTACHMENT	JAW OPENING	USE WITH INSULATOR	WIRE AWG	PLATING
BU-60CHS	10	Crimp/Screw	5/16"	Insul. Barrel	14-20	Solid Copper
BU-60CS	10	Crimp/Screw	5/16"	62	14-20	Solid Copper
BU-60H	10	Crimp/Solder	5/16"	Insul. Barrel	14-20	Nickel
BU-60HS	10	Crimp/Screw	5/16"	Insul. Barrel	14-20	Nickel
BU-60HPR	10	Pin/Prod Tip	5/16"	Insul. Barrel	NA	Nickel
BU-60PR2	10	Pin/Prod Tip	5/16"	62	NA	Nickel
BU-60S	10	Crimp/Screw	5/16"	62	14-20	Nickel
BU-60TBO	10	Threaded	5/16"	62	NA	Nickel
BU-60U	10	Crimp/Solder	5/16"	62	14-20	Nickel
BU-60X	10	Crimp/Solder/Plug-On	5/16"	62	14-20	Stainless Steel
BU-61	10	Pin/Prod Tip	5/16"	62	NA	Nickel
BU-63	10	Crimp/Screw	1/4"	Insulated	14-20	Nickel
BU-63C	10	Crimp/Screw	1/4"	Insulated	14-20	Solid Copper
BU-65-*	30	Plug-on	3/4"	Insulated	NA	Nickel
BU-651-*	10	Plug-On	17/64"	insulated	NA	Nickel
BU-652-*	20	Plug-On	17/64"	insulated	NA	Nickel
BU-654-*	20	Plug-On	1"	insulated	NA	Nickel
BU-656-*	30	Plug-On	51/64"	insulated	NA	Nickel
BU-70	5	Crimp/Solder	5/16"	72	16-20	Nickel
BU-70C	10	Crimp/Solder	5/16"	72	16-20	Copper
BU-70CS	10	Crimp/Screw	5/16"	72	16-20	Copper
BU-70S	5	Crimp/Screw	5/16"	72	16-20	Nickel
BU-75K	10	Screw	5/16"	Insulated	NA	Silver
BU-78K	10	Solder	1/2"	None	NA	Gold
BU-85	5	Crimp/Screw	5/16"	87	14-20	Zinc
BU-85C	10	Crimp/Screw	5/16"	87	14-20	Solid Copper
BU-95	10	Crimp/Screw	7/16"	74	14-20	Zinc
BU-X15400-*	400	Crimp	1 1/2"	insulated	Up to 1	Copper Jaws
JP-25182	5	Crimp/Screw	1"	8681	Up to 10	Nickel/Silver
JP-33699	5	Crimp/Screw	1"	8681	Up to 10	Nickel/Silver
JP-33674	5	Crimp/Screw	1"	8681	Up to 10	Nickel/Silver
JP-5869-B	20	Crimp/Screw	5/8"	29/90	Up to 12	Zinc
JP-5869-C	20	Crimp/Screw	5/8"	29/90	Up to 12	Zinc
JP-8078	5	Crimp/Screw	1"	8681	Up to 10	Nickel/Silver
JP-8099	5	Crimp/Screw	1"	8681	Up to 10	Nickel/Silver
JP-8783	5	Crimp/Screw	1"	8681	Up to 10	Nickel/Silver