

G5RL-U/-K

PCB Power Relay

16 A High Switching Current, General-purpose Latching Relay



- Creepage distance 8 mm between coil and contacts.
- 10 kV Impulse withstand voltage.
- Ambient Operating Temperature 85°C
- Suitable for TV-8 rating. (SPST-NO (1a))

RoHS Compliant

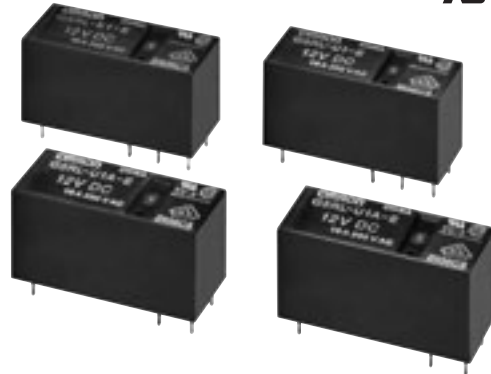

NEW

Model Number Legend

G5RL-□□□-□
1 2 3 4

1. Relay Function

U : Single-winding latching
K : Double-winding latching

3. Contact Form

None: SPDT (1c)
A : SPST-NO (1a)

2. Number of poles

1 : 1-Pole

4. Classification

E : High-capacity

Application Examples

- Housing equipments
- Building Automation
- UPS, FA equipment
- Electric power meter

G5RL-U/-K

Ordering Information

Classification	Terminal Shape	Contact form	Enclosure rating	Single-winding latching		Double-winding latching		Minimum packing unit
				Model	Rated coil voltage	Model	Rated coil voltage	
High-capacity	PCB terminals	SPST-NO (1a)	Flux protection	G5RL-U1A-E	3 VDC 5 VDC 6 VDC	G5RL-K1A-E	5 VDC 12 VDC 24 VDC	100 pcs/tray
		SPDT (1c)		G5RL-U1-E	12 VDC 24 VDC	G5RL-K1-E		

Note. When ordering, add the rated coil voltage to the model number.

Example: G5RL-U1A-E DC5

□□—Rated coil voltage

However, the notation of the coil voltage on the product case as well as on the packing will be marked as □□ VDC.

Ratings

Coil

Single-winding Latching Type

Rated Voltage	Rated current (mA)	Coil resistance (Ω)	Must set voltage	Must reset voltage	Max voltage	Power consumption (W)
			% of rated voltage			
3 VDC	200	15	70% max.	70% max.	130%	Approx. 0.6
5 VDC	120	41.7				
6 VDC	100	60				
12 VDC	50	240				
24 VDC	25	960				

Double-winding Latching Type

Rated Voltage	Rated current (mA)		Coil resistance (Ω)		Must set voltage	Must reset voltage	Max voltage	Power consumption (W)	
	Set coil	Reset coil	Set coil	Reset coil				Set coil	Reset coil
5 VDC	150		33.3		70% max.	70% max.	130%	Approx. 0.75	
12 VDC	62.5		192					Approx. 0.84	
24 VDC	35		686						

Note. The rated current and resistance are measured at a coil temperature of 23°C with a tolerance of ±10%.

●Contacts

Load	Resistive load	
Contact form	SPST-NO (1a)	SPDT (1c)
Contact type	Single	
Contact material	Ag Alloy (Cd free)	
Rated load	16 A at 250 VAC 16 A at 24 VDC	16 A at 250 VAC (N.O) 5 A at 250 VAC (N.C) 16 A at 24 VDC (N.O) 5 A at 24 VDC (N.C)
Rated carry current	16 A	16 A (N.O), 5A (N.C)
Max. switching voltage	250 VAC, 24 VDC	
Max. switching current	16 A	16 A (N.O), 5 A (N.C)

■Characteristics

Item	Classification Relay function	SPST-NO (1a), SPDT (1c)
		Single-winding Latching, Double-winding Latching
Contact resistance *1		100 mΩ max.
Set time		10 ms max.
Reset time		10 ms max.
Minimum pulse width *2		30 ms
Maximum pulse width *2		1 min
Insulation resistance *3		1,000 MΩ min.
Dielectric strength	Between coil and contacts	6,000 VAC, 50/60 Hz for 1 min
	Between contacts of the same polarity	1,000 VAC, 50/60 Hz for 1 min
Impulse withstand voltage	Between coil and contacts	10 kV (1.2 × 50 μs)
Insulation distance	Between coil and contacts	Clearance: 6.4 mm, Creepage: 8 mm
Vibration resistance	Destruction	10 to 55 to 10 Hz, 0.75 mm single amplitude (1.5 mm double amplitude)
	Malfunction	10 to 55 to 10 Hz, 0.75 mm single amplitude (1.5 mm double amplitude) at Set status 10 to 55 to 10 Hz, 0.75 mm single amplitude (1.5 mm double amplitude) at Reset status (Except SPST-NO)
Shock resistance	Destruction	1,000 m/s ²
	Malfunction	150 m/s ² at Set status 50 m/s ² at Reset status (Except SPST-NO)
Durability	Mechanical *4	5,000,000 operations min.
	Electrical *4	50,000 operations min.
Ambient operating temperature		-40° to 85°C (with no icing or condensation)
Ambient operating humidity		5% to 85%
Weight		Approx. 10 g

Note. Values in the above table are initial values.

*1. The contact resistance is measured with 1 A applied at 5 VDC using a fall-of-potential method.

*2. These are measured at a coil temperature of 23°C and rated coil voltage.
Pulse duty factor should be 10% MAX.

*3. The insulation resistance is measured between coil and contacts and between contacts of same polarity at 500 VDC.

*4. Operated with input pulse width "30 ms".

■Engineering Data

●Maximum Switching Power

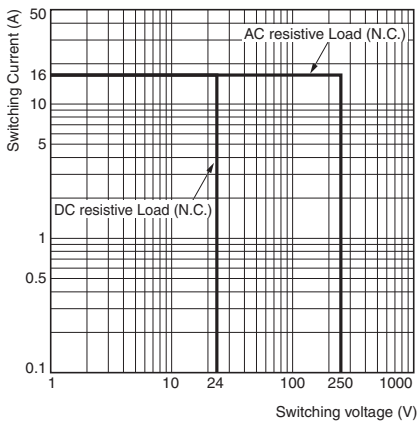

●Ambient Temperature vs. Maximum Coil Voltage

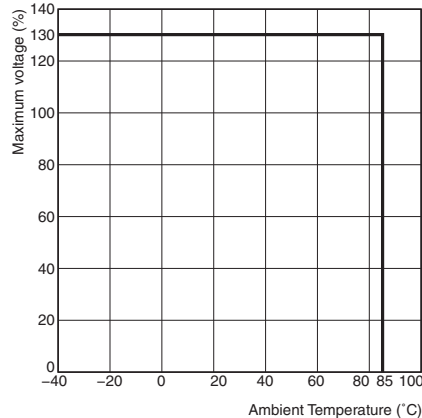

Note. Maximum voltage of Set pulse and Reset pulse at duty factor 10%.

●Malfunction Shock

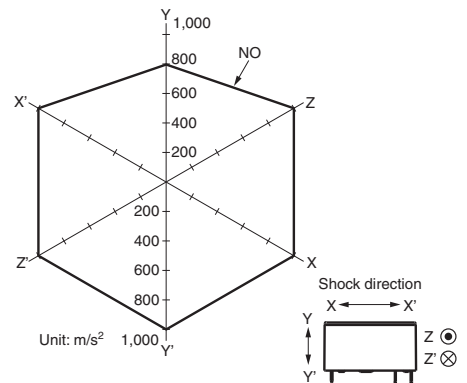

Sample: G5RL-K1A-E 12VDC

No. of relays: 5 pcs

Test Conditions: Shock is applied in ±X, ±Y, and ±Z directions three times each with Set and Reset status to check the number of contact malfunctions.

Standard value: 50 m/s² with Set status
100 m/s² with Reset status

■Dimensions

(Unit: mm)

G5RL-U1A-E

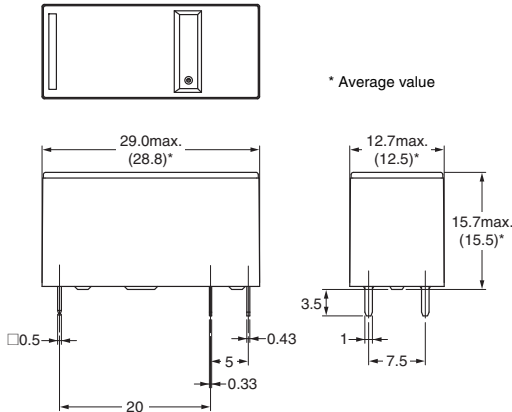
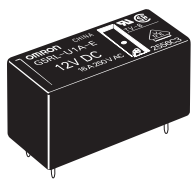

PCB Mounting Holes (BOTTOM VIEW)

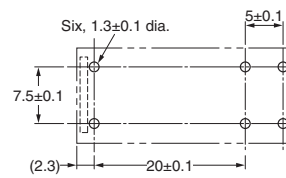

Terminal Arrangement/ Internal Connections (BOTTOM VIEW)

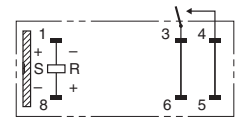

Note. Check carefully the coil polarity of the Relay.

Note. Orientation marks are indicated as follows:

G5RL-U1-E

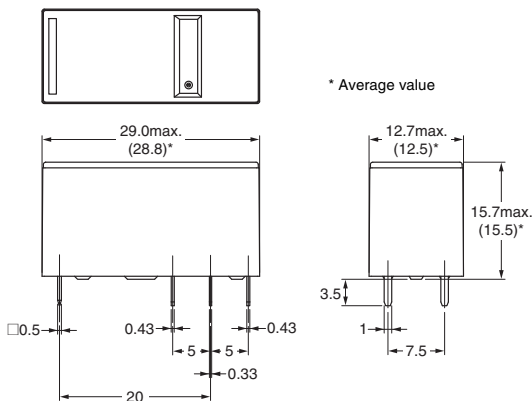
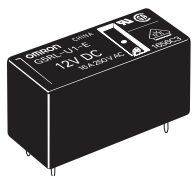

PCB Mounting Holes (BOTTOM VIEW)

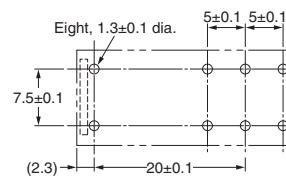

Terminal Arrangement/ Internal Connections (BOTTOM VIEW)

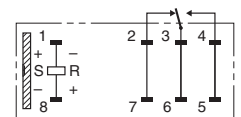

Note. Check carefully the coil polarity of the Relay.

Note. Orientation marks are indicated as follows:

G5RL-U/-K

G5RL-K1A-E

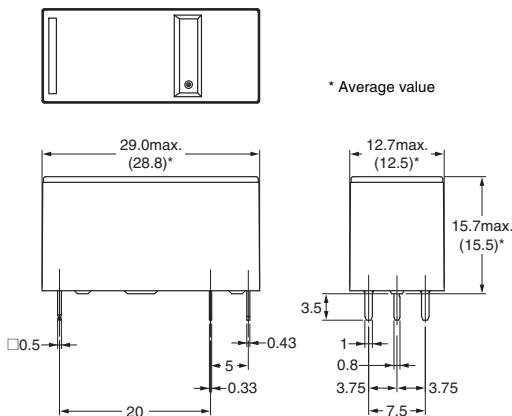
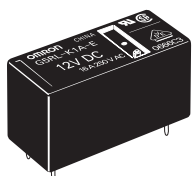

PCB Mounting Holes (BOTTOM VIEW)

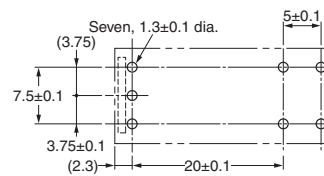

Terminal Arrangement/ Internal Connections (BOTTOM VIEW)

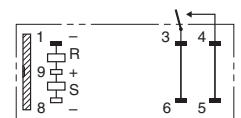

Note. Check carefully the coil polarity of the Relay.

Note. Orientation marks are indicated as follows:

G5RL-K1-E

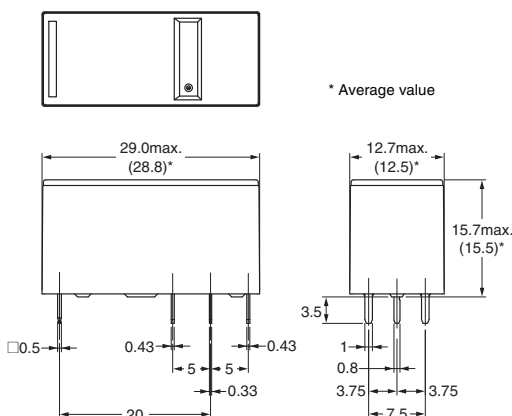
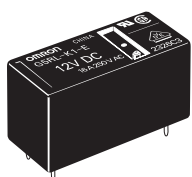

PCB Mounting Holes (BOTTOM VIEW)

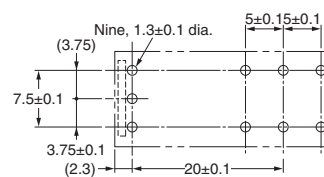

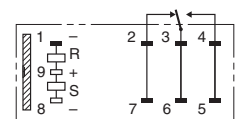

Terminal Arrangement/ Internal Connections (BOTTOM VIEW)



Note. Check carefully the coil polarity of the Relay.

Note. Orientation marks are indicated as follows:

Approved Standards

●  **UL Recognized (File No. E41643) and**  **CSA Certified (File No. LR31928)**

Model	Contact form	Coil ratings	Contact ratings	Number of test operations
G5RL-U1A-E G5RL-K1A-E	SPST-NO (1a)	5 to 24 VDC (“-U” models: 3 to 24 VDC)	16 A 277 VAC (Resistive) - NO 85°C	50,000
			TV-5 - NO 40°C	25,000
			TV-8 - NO 40°C	25,000
			8 A 250 VAC (Ballast) - NO 40°C	6,000
G5RL-U1-E G5RL-K1-E	SPDT (1c)	5 to 24 VDC (“-U” models: 3 to 24 VDC)	2,000 W 250 VAC (Tungsten) 70°C	6,000
			16 A 277 VAC (Resistive) - NO 85°C	50,000
			8 A 250 VAC (Ballast) - NO 40°C	6,000
			2,000 W 250 VAC (Tungsten) - NO 40°C	6,000
			5 A 250 VAC (General) - NC 40°C	50,000

●  **VDE Certified (EN61810-1) (License No. 40007172)**

Model	Contact form	Coil ratings	Contact ratings	Number of test operations
G5RL-U1A-E G5RL-K1A-E	SPST-NO (1a)	5, 12, 24 VDC (“-U” models: 3, 5, 6, 12, 24 VDC)	16 A 250 VAC (cosφ=1) - NO 85°C	30,000
			240 VAC 100 A (0-P) Steady 10 A (rms) - NO 85°C	50,000
G5RL-U1-E G5RL-K1-E	SPDT (1c)	3, 5, 6, 12, 24 VDC)	16 A 250 VAC (cosφ=1) - NO 85°C	30,000
			5 A 250 VAC (cosφ=1) - NC 85°C	30,000

Precautions

● Please refer to “PCB Relays Common Precautions” for correct use.

Correct Use

Basic Operation of Latching Relays

- In these Relays, the input pulse of the set coil causes the operating condition to be maintained magnetically or mechanically, whereas the input pulse to the reset coil side puts the Relay into the reset condition.

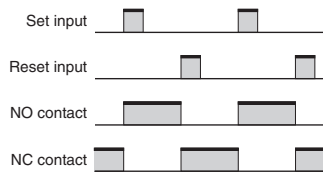

Coil Temperature Rise of long time continuous current to the coil

- When the coil is applied continuous current for a long time, the coil would be heat too much. Please decide the coil Input pulse width by “heat and cold of coil temperature”

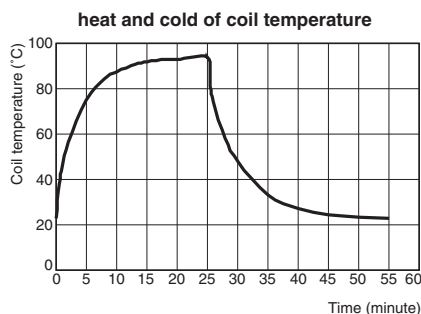

Wiring of High-capacity Models (-E)

- High-capacity models (-E) have a structure that connects two terminals from one contact. When designing the circuit, use both terminals. If you use only one terminal, the Relay may be unable to satisfy specified performance.

Precautions for Correct Use

- This product is not suitable for vehicles such as automobiles (including two-wheeled vehicles).
- If the product is used in the following applications, consult your OMRON sales representative to check the necessary items according to the specification sheets. Also make sure the product is used within the specified ratings and performance ranges with an ample margin and implement safety measures, such as designing a safety circuit, to minimize danger should the product fail.
 - Outdoor use, uses involving potential chemical contamination or electrical interference.
 - Nuclear energy control systems, combustion systems, railroad systems, aviation systems, medical equipment, safety equipment, and equipment that could present a risk to human life or body.
 - Equipment requiring a high level of reliability, such as gas, water, or electrical supply systems.

● Application examples provided in this document are for reference only. In actual applications, confirm equipment functions and safety before using the product.
 ● Consult your OMRON representative before using the product under conditions which are not described in the manual or applying the product to nuclear control systems, railroad systems, aviation systems, vehicles, combustion systems, medical equipment, amusement machines, safety equipment, and other systems or equipment that may have a serious influence on lives and property if used improperly. Make sure that the ratings and performance characteristics of the product provide a margin of safety for the system or equipment, and be sure to provide the system or equipment with double safety mechanisms.

Note: Do not use this document to operate the Unit.