

# SOLENOID PRODUCT SPECIFICATION

PART No.	VOLTAGE	DUTY CYCLE	POWER (W)	CURRENT (A)	DCR (Ω) *
DSML-0224-24	24 VDC	0.2%, 20 msec On.	13	0.54	44
DSML-0224-18	18 VDC	0.2%, 20 msec On.	13	0.73	24.6
DSML-0224-12	12 VDC	0.2%, 20 msec On.	12	1.0	12
DSML-0224-09	9 VDC	0.2%, 20 msec On.	11.2	1.22	7.4
DSML-0224-05	5 VDC	0.2%, 20 msec On.	13	2.62	1.9

\* OPERATION: POWER TO PULL AND RELEASE, BUILT-IN RETURN SPRING.

\* DCR VALUES ARE ±10% AT 25°C

\* WEIGHT ARE 5.5 GRAMS ±10%

1. MECHANICAL DIMENSIONS :

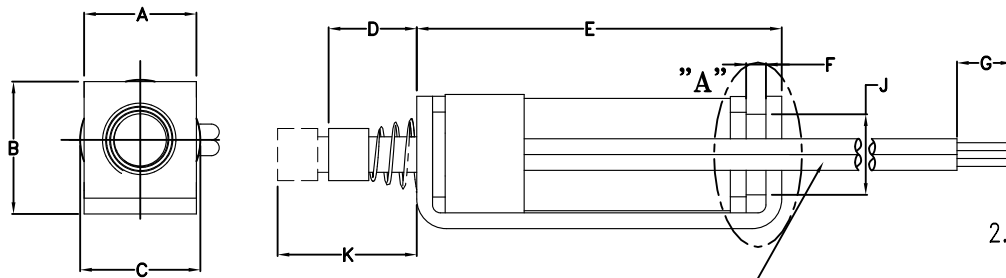

LEAD WIRE.  
(NOTE 1)

2. SCHEMATIC AND CONSTRUCTION :

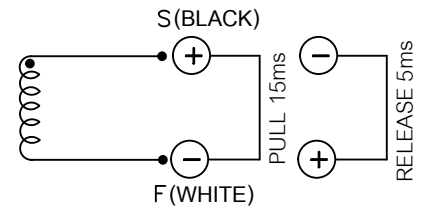

START BLACK.  
FINISH WHITE.

UNIT : mm.

- A = 7.11 ± 0.1
- B = 8.38 ± 0.1
- C = 8.35 MAX.
- D = 5.58 ± 0.2
- E = 23.11 ± 0.2
- F = 1.00±0.05
- G = 4.0 ± 1.0
- H = ø3.30 ± 0.1
- I = 2.54 ± 0.1
- J = 5.04 ± 0.05
- K = 11.5 ± 0.5

UNLESS TOLERANCES.

- X.X = ±0.4
- X.XX = ±0.15
- ANGLES = ± 0.5°

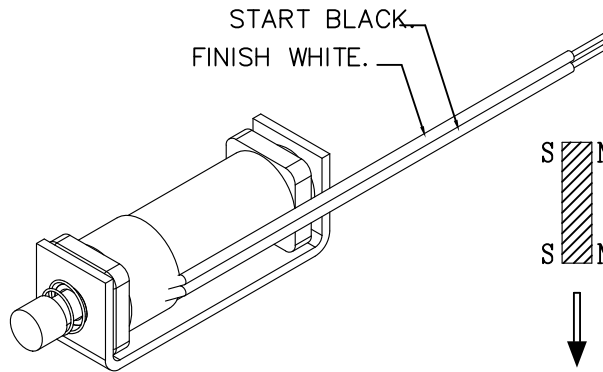
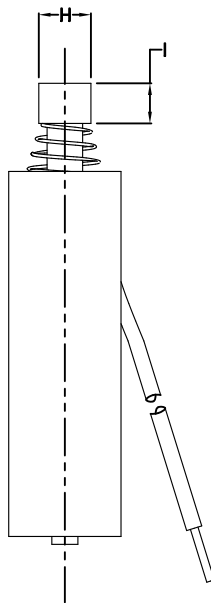

ISOMETRIC VIEW

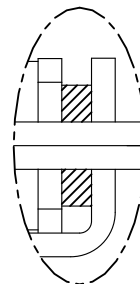
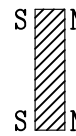

MAGNET DIRECTION  
DETAIL "A"

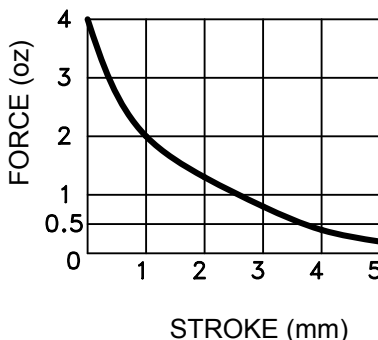

INSULATION MATERIALS: UL CONSTRUCTION, CLASS A 105°C  
 LIFE EXPECTANCY: 100K CYCLES OPERATIONS

LAYER TEST	IR. @500 Vdc.	HI-POT
(S-F) : 500Vp. MIN.	COIL TO FRAME	@50/60Hz.,2mA
TEST ONLY COIL	30 MOHM MIN.	COIL TO FRAME
		500Vac., 1s