



Built-in Bypass Relay and Smooth Motor Starts/Stops Achieved in a Compact Starter

- Advanced functions include soft start, kick start, and soft stop.
- Phase control using a thyristor limits current when the motor starts, and a bypass relay minimizes power loss while the motor is running.
- Controls 3-phase, 3-wire motor or 3-phase, 6-wire motor.
- Built-in electronic thermal overload relay.
- Built-in fault diagnosis for overtemperature, phase reversal, phase loss/open load, current imbalance, and shorted SCR.
- cULus listed; complies with IEC standards.
- Mounts with screws or to DIN track.
- Built-in operation/fault indicator.
- Built-in auxiliary contact for fault indication.
- Built-in auxiliary contact to output operating status.
- An Optional Auxiliary Contact Block can be added to output operating status.



Refer to *Safety Precautions* on page 16.

Characteristics

Item	Type	3-phase, 3-lead motor	3-phase, 6-lead motor (star-delta wiring)
		Applicable motors	
	Rated operating voltage (motor)	200 to 480 VAC (±10%) 50/60 Hz (±5%)	
	Rated operating current (motor)	3 to 37 A	3 to 64 A
	Applicable motor capacity IEC 60947-4-2, 230 VAC	0.55 to 7.5 kW	0.55 to 18.5 kW
Functions	Voltage control start (See note.)		○
	Kick start		○
	Current limit start (See note.)		○
	Soft stop		○
	Fault detection relay output (NO)		○
	Auxiliary contact output (NO)		○
	Optional Auxiliary Contact Block output		○
	Fault detection LED indicator		○
	Overload protection		○
	Phase reversal detection		○
Current imbalance detection		○	

Note: Select either voltage control start or current limit start.

Applicable Motors

Three-phase, 3-wire Motor (Line)

The G3JA-C can be used for a 3-phase, 3-wire motor as shown in the following diagram. (Star-delta wiring for the motor is required if a 3-phase, 6-wire motor is used.)

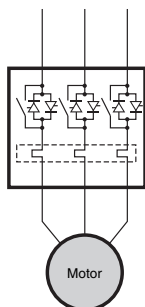

Three-phase, 6-wire Motor (Delta)

A 3-phase, 6-wire motor (that supports a star-delta operation start) can be used. The G3JA-C is compact and includes functionality for devices that start operation with star-delta (Y-Δ) wiring.

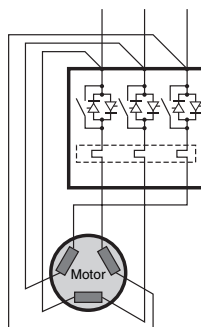

Model Number Structure

Model Number Legend

Soft Starter

G3JA-C□□□□□
1 2 3 4 5

- 1. Controller Type**
C: Soft start/stop
- 2. Rated Operating Voltage of Main Circuit**
4: 200 to 480 VAC, 3 phase, 50/60 Hz
- 3. Rated Operating Current of Main Circuit**
03: 3 A 19: 19 A 30: 30 A
09: 9 A 25: 25 A 37: 37 A
16: 16 A
- 4. Terminal Type**
B: Screw terminals (screw clamps)
- 5. Control Voltage**
AC100-240: 100 to 240 VAC 50/60 Hz
AC/DC24: 24 VAC 50/60 Hz, 24 VDC

Accessories

G32J-□□
1 2

- 1. Option**
CA: Auxiliary Contact Block
- 2. Number of Contacts**
10: 1 NO 01: 1 NC
20: 2 NO 11: 1 NO/1 NC

G32J-□
1

- 1. Option**
CF64: Fan
TA10: Round Terminal Block Adapter

Ordering Information

List of Models

Soft Starters (Complies with IEC 60947-4-2, UL508)

Three-phase, 3-wire Motors

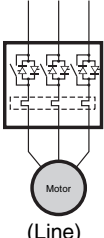
Applicable motor wiring	Rated Operating Current of Main Circuit		Applicable motor capacity (reference values)						Model
	Current rating (A)	Adjustable range (A)	kW			HP			
			200 VAC 50/60 Hz	230 VAC 50 Hz	380/400/415 VAC 50 Hz	200 VAC 60 Hz	230 VAC 60 Hz	460 VAC 60 Hz	
 (Line)	3	1 to 3	0.2 to 0.4	0.37	0.75	0.5	0.5	0.5 to 1	G3JA-C403B AC100-240 G3JA-C403B AC/DC-24
	9	3 to 9	0.55 to 1.5	1.5	3	0.75 to 1.5	0.75 to 2	1.5 to 3	G3JA-C409B AC100-240 G3JA-C409B AC/DC-24
	16	5.3 to 16	1.1 to 2.2	3	5.5	1.5 to 3	1.5 to 3	5 to 7.5	G3JA-C416B AC100-240 G3JA-C416B AC/DC-24
	19	6.3 to 19	1.5 to 3.7	4	5.5	1.5 to 3	2 to 3	5 to 10	G3JA-C419B AC100-240 G3JA-C419B AC/DC-24
	25	8.3 to 25	2.2 to 5.5	4	9.5	3 to 5	3 to 5	7.5 to 10	G3JA-C425B AC100-240 G3JA-C425B AC/DC-24
	30	10 to 30	2.2 to 5.5	5.5	11	3 to 5	5 to 7.5	7.5 to 15	G3JA-C430B AC100-240 G3JA-C430B AC/DC-24
	37	12.3 to 37	3.7 to 7.5	7.5	15	5 to 7.5	5 to 10	10 to 20	G3JA-C437B AC100-240 G3JA-C437B AC/DC-24

Note: The applicable motor capacities given in the table are reference values. The motor FLA must fall within the current range of the device. It is not possible to use motors that are outside the adjustable range of the Soft Starter.

Three-phase, 6-wire Motors (Star-delta Wiring)

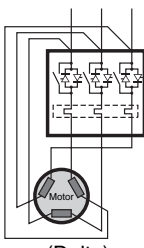
Applicable motor wiring	Rated operating current of main circuit		Applicable motor capacity (reference values)						Model
	Current rating (A)	Adjustable range (A)	kW			HP			
			200 VAC 50/60 Hz	230 VAC 50 Hz	380/400/415 VAC 50 Hz	200 VAC 60 Hz	230 VAC 60 Hz	460 VAC 60 Hz	
 (Delta)	3	1.7 to 5.1	---	0.25 to 1.1	0.55 to 2.2	1	1	0.5 to 2	G3JA-C403B AC100-240 G3JA-C403B AC/DC-24
	9	5.1 to 16	---	1.1 to 4	2.2 to 7.5	1.5 to 3	1 to 5	2 to 7.5	G3JA-C409B AC100-240 G3JA-C409B AC/DC-24
	16	9.1 to 27.6	---	2.2 to 7.5	4 to 11	3 to 7.5	3 to 10	5 to 15	G3JA-C416B AC100-240 G3JA-C416B AC/DC-24
	19	10.9 to 32.8	---	2.2 to 7.5	4 to 15	3 to 10	3 to 10	5 to 15	G3JA-C419B AC100-240 G3JA-C419B AC/DC-24
	25	14.3 to 43	---	4 to 11	5.5 to 22	3 to 10	3 to 15	7.5 to 20	G3JA-C425B AC100-240 G3JA-C425B AC/DC-24
	30	17.3 to 52	---	4 to 15	7.5 to 22	5 to 10	5 to 15	7.5 to 30	G3JA-C430B AC100-240 G3JA-C430B AC/DC-24
	37	21 to 64	---	5.5 to 18.5	7.5 to 30	7.5 to 20	7.5 to 20	10 to 30	G3JA-C437B AC100-240 G3JA-C437B AC/DC-24

Note: The applicable motor capacities given in the table are reference values. The motor FLA must fall within the current range of the device. It is not possible to use motors that are outside the adjustable range of the Soft Starter.

Upgraded Models

Production of a new version of the Soft Starter (version 2) with added functions was started in August 2008. The DIP switch settings of the new version are different from the previous version. For details, refer to *Upgrades for Version 2* on page 13.

When replacing G3JA-C (version 2) with G3JA-D, refer to "Three-phase, 6-wire Motors (Star-delta Wiring)" list above.

Accessories (Order Separately)

Product name	Model	Remarks
Auxiliary Contact Blocks	G32J-CA10	Contact configuration: 1 NO
	G32J-CA20	Contact configuration: 2 NO
	G32J-CA01	Contact configuration: 1 NC
	G32J-CA11	Contact configuration: 1 NO/1 NC
Fan	G32J-CF64	
Round Terminal Block Adapters	G32J-TA10	Set of 2 Adapters

Note: Refer to *Safety Precautions* on page 16.

Specifications

■ Ratings and Characteristics

Ratings

Item	Model	G3JA-C403	G3JA-C409	G3JA-C416	G3JA-C419	G3JA-C425	G3JA-C430	G3JA-C437
Rated operating current		3 A	9 A	16 A	19 A	25 A	30 A	37 A
Heat dissipation, continuous		11 W	12 W	14 W	15 W	17 W	19 W	24 W
Rated operating voltage of main circuit		200 to 480 VAC ($\pm 10\%$), 50/60 Hz ($\pm 5\%$), 3-phase						
Main circuit power supply terminals (L1, L2, and L3)	Wire gauge	2.5 to 25 mm ² (14 to 4 AWG), Stripping length (recommended): 11 mm						
	Tightening torque	2.3 to 3.4 N·m						
Main circuit load power terminals (T1, T2, and T3)	Wire gauge	2.5 to 16 mm ² (14 to 6 AWG), Stripping length (recommended): 11 mm						
	Tightening torque	2.3 to 3.4 N·m						
Control terminals (A1, A2, IN1, IN2, 97, 98, 13, and 14)	Wire gauge	0.2 to 2.5 mm ² (24 to 14 AWG), Stripping length (recommended): 9 mm						
	Tightening torque	0.5 to 0.9 N·m						
Overload current range		1 to 3 A	3 to 9 A	5.3 to 16 A	6.3 to 19 A	8.3 to 25 A	10 to 30 A	12.3 to 37 A
Control voltage		100 to 240 VAC or 24 VAC, 50/60 Hz, 24 VDC						

Note: The load can be switched up to four times per hour. (Conditions: Rated current applied, Ambient temperature: 50°C max., Limit current: 300%, Start time: 15 s, ON time ratio: 70% max.) By using optional fans, however, it is possible to switch the load up to ten times per hour under the same conditions.

G3JA Switching Frequency

G3JA-C (40°C, Start time: 10 s, Current limit: 350% without fan)

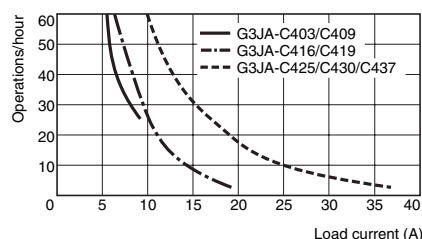

G3JA-C (40°C, Start time: 10 s, Current limit: 350% with fan used)

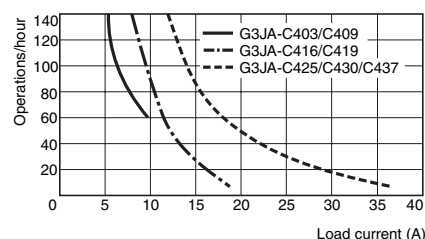

Short Circuit Coordination (Maximum Fuse or Circuit Breaker Size) Type 1

Item	Model	G3JA-C403	G3JA-C409	G3JA-C416	G3JA-C419	G3JA-C425	G3JA-C430	G3JA-C437
UL Class K5 and RK5 fuse		Rated breaking current: 5 kA						
UL-listed combination (600 V)		12 A	30 A	60 A	70 A	100 A	110 A	125 A
UL-listed thermal electromagnetic circuit breaker		Rated breaking current: 5 kA						
UL-listed combination (600 V)		12 A	30 A	60 A	70 A	100 A	110 A	125 A

Main Circuit

Item	Classification	cULus (UL 508)	IEC (EN/IEC 60947-4-2)
Rated operating voltage		200 to 480 VAC	400 VAC
Isolation rated voltage		600 VAC	500 VAC
Dielectric strength (between the control and main circuits)		2,200 VAC	2,500 VAC
Repetitive peak voltage		1,400 V	
Operating frequency		50/60 Hz ($\pm 5\%$)	
Utilization category		Intermittent duty	AC-53b
Single-phase/3-phase		Equipment designed for 3-phase only	
Rated impulse voltage		6 kV	
DV/DT protection		1,000 V/ μ s	
Overvoltage category		III	

Control Circuits

Item	Classification	cULus (UL 508)	IEC (EN/IEC 60947-4-2)
Rated operational voltage		100 to 240 VAC 50/60 Hz, 24 VAC 50/60 Hz, 24 VDC	
Voltage range		±10% of control voltage	
Overvoltage category		---	III (See note.)
Input onstate voltage minimum during start (A1, A2)		90 VAC max. (100 to 240 VAC), 15.2 VAC/21.6 VDC max. (24 VAC/DC)	
Input onstate current, during start with the G32J-CF64 Fan (IN1, IN2)		9.8 mA at 120 VAC; 19.6 mA at 240 VAC, 7.3 mA at 24 VAC/DC	
Input offstate voltage maximum (A1, A2)		15 VAC min. (100 to 240 VAC), 3.6 VAC/5.1 VDC min. (24 VAC/VDC)	
Offstate current consumption (IN1, IN2)		10 mA max. (IN1), 12 mA max. (IN2)	
Onstate current consumption, with Fan (A2)		215 mA max. at 120 VAC/180 mA max. at 240 VAC, 660 mA max. at 24 VAC/800 mA max. at 24 VDC	
Onstate current consumption, without Fan (A2)		205 mA max. at 120 VAC/145 mA max. at 240 VAC, 580 mA max. at 24 VAC/705 mA max. at 24 VDC	

Note: Overvoltage category II applies when control or auxiliary contacts are connected to an SELV or PELV circuit.

Auxiliary Contacts

Item	Classification	cULus (UL 508)	IEC (EN/IEC 60947-4-2)
Rated operational voltage		250 VAC/30 VDC	
Rated impulse voltage		---	4 kV
Dielectric strength		1,500 VAC	2,000 VAC
Overvoltage category		---	III (See note.)
Operating frequency		50/60 Hz	
Utilization category		D300	AC15
TB-97, -98 (overload/fault)	Control circuit configuration	Electromagnetic relay	
	Number of contacts	1	
	Contact	NO contact	
	Current specifications	AC/DC	
	Rated operating current	0.6 A at 120 VAC, 0.3 A at 240 VAC	
TB-13, -14 (normal/up-to-speed)	Control circuit configuration	Electromagnetic relay	
	Number of contacts	1	
	Contact	NO contact	
	Current specifications	AC/DC	
	Rated operating current	0.6 A at 120 VAC, 0.3 A at 240 VAC	
Contact switching capacity	Open: 72 VA Close: 432 VA		

Note: Overvoltage category II applies when control or auxiliary contacts are connected to an SELV or PELV circuit.

Standard Functions

Item	Classification	cULus (UL 508)	IEC (EN/IEC 60947-4-2)
Start time		2 s, 5 s, 10 s, 15 s, 20 s, 25 s, or 30 s	
Soft start (initial torque)		15%, 25%, 35%, or 65% of locked rotor torque	
Current limit		150%, 250%, 350%, or 450% of full-load current	
Soft stop time		0%, 100%, 200%, or 300% of the start time	
Weight		Approx. 860 g	

Vibration and Shock Resistance

Item	Classification	cULus (UL 508)	IEC (EN/IEC 60947-4-2)
Vibration resistance	Destruction	25-m/s ² peak, 10 to 55 to 10 Hz, 0.19-mm single amplitude	
	Malfunction	10-m/s ² peak, 10 to 55 to 10 Hz, 0.075-mm single amplitude	
Shock resistance	Destruction	300 m/s ² (30 G)	
	Malfunction	150 m/s ² (15 G)	

Environmental Conditions

Item	Classification	cULus (UL 508)	IEC (EN/IEC 60947-4-2)
Ambient operating temperature		0 to 50°C	
Ambient storage temperature		-25 to 85°C	
Elevation		2,000 m max.	
Ambient operating humidity		5% to 85% (with no condensation)	
Pollution degree		2	
Degree of protection		IP20	

Other Specifications

Item	Classification	cULus (UL 508)	IEC (EN/IEC 60947-4-2)
EMI (emission test)	Noise terminal voltage	---	Class A
	Radiation field	---	Class A
EMS (immunity test)	Electrostatic discharge	4 kV contact discharge and 8 kV air discharge	
	Radio frequency electromagnetic field	---	Conforms to IEC 60947-4-2
	Electrical fast transient	---	Conforms to IEC 60947-4-2
	Surge immunity	---	Conforms to IEC 60947-4-2

■ Applicable Standards

Safety standards	UL 508 (Listing: File No. E64562), CSA 22.2 No. 14, EN/IEC 60947-4-2
------------------	--

Connections

■ Wiring

Two-wire Connections

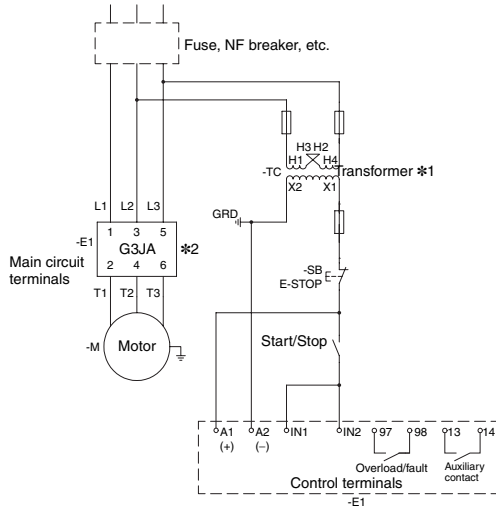

Operation Chart: Two-wire Connections with Main Circuit Fault Shutoff

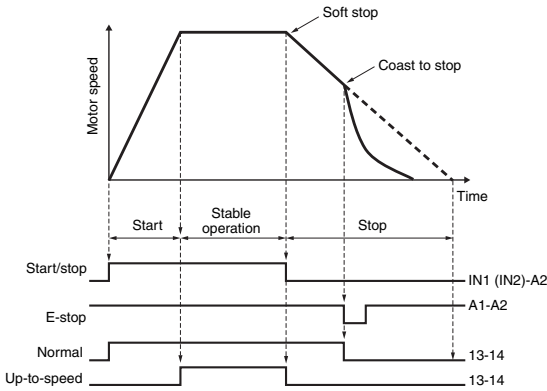

- *1. This transformer is used to convert the load voltage into the control voltage of the G3JA. A transformer is not required if the load voltage is within the rated operational voltage range of the G3JA.
- *2. The wiring in the following diagram is used for a 3-phase, 6-wire motor (Delta).

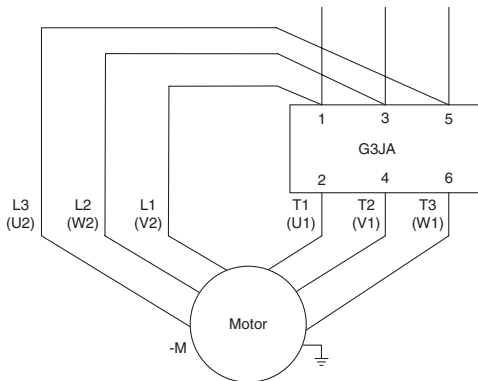

Three-wire Connections

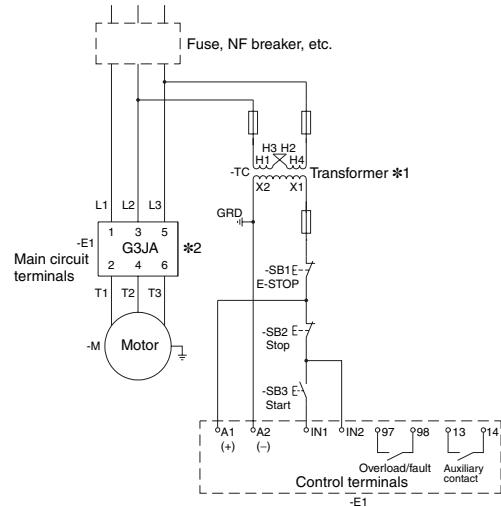

Operation Chart: Three-wire Connections with Main Circuit Fault Shutoff

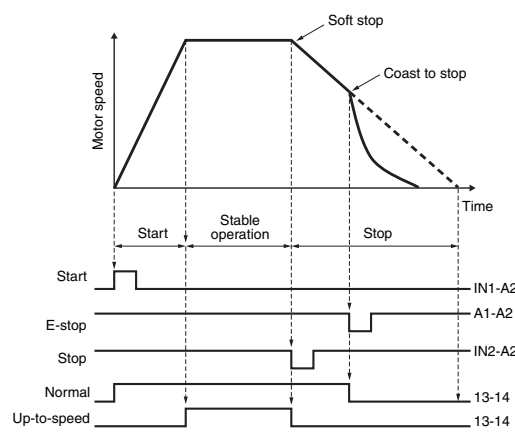

- *1. This transformer is used to convert the load voltage into the control voltage of the G3JA. A transformer is not required if the load voltage is within the rated operational voltage range of the G3JA.
- *2. The wiring in the following diagram is used for a 3-phase, 6-wire motor (Delta).

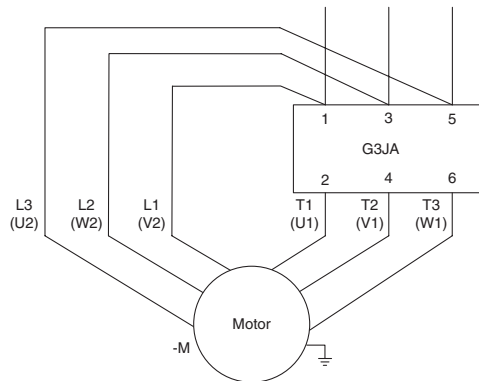

Examples: Main Circuit Fault Shutoff

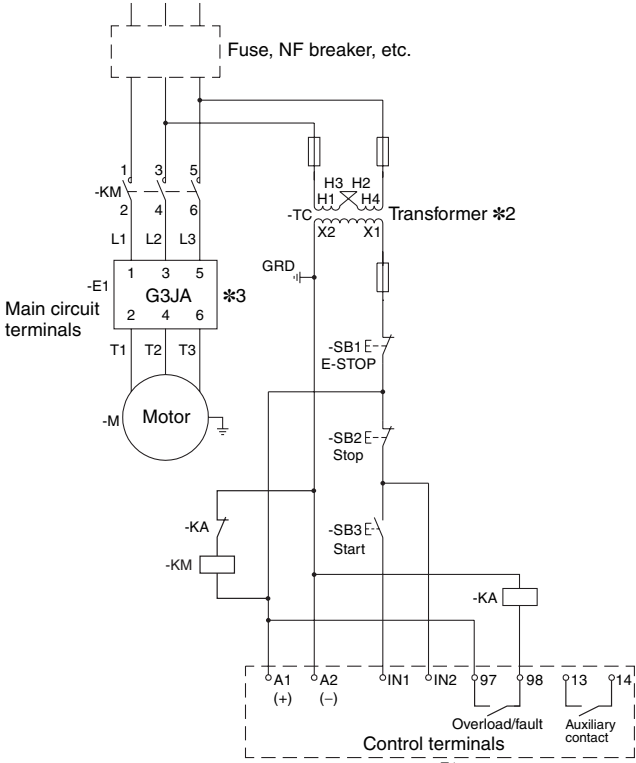

Operation Chart: Three-wire Connections with Main Circuit Fault Shutoff

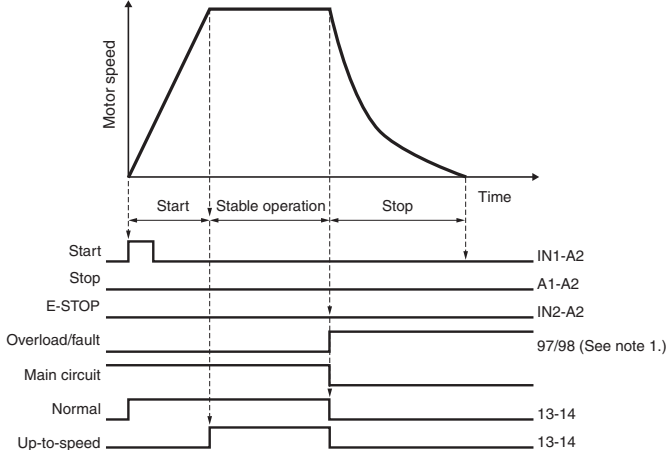

- *1. If an overload or other fault is detected, the main circuit will turn OFF, and the alarm contact (97-98) built into the G3JA will operate. (Refer to *Description of Functions* on page 9 for details.)
- *2. This transformer is used to convert the load voltage into the control voltage of the G3JA. A transformer is not required if the load voltage is within the rated operational voltage range of the G3JA.
- *3. The wiring in the following diagram is used for a 3-phase, 6-wire motor (Delta).

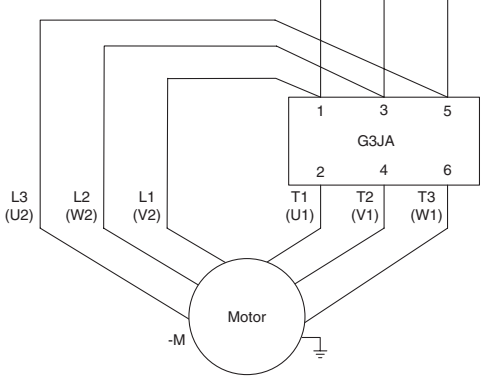

Forward/Reverse Rotation

- Note: 1. Provide a time lag of at least 1.0 s between forward and reverse rotation.
- 2. Disable phase reversal protection.

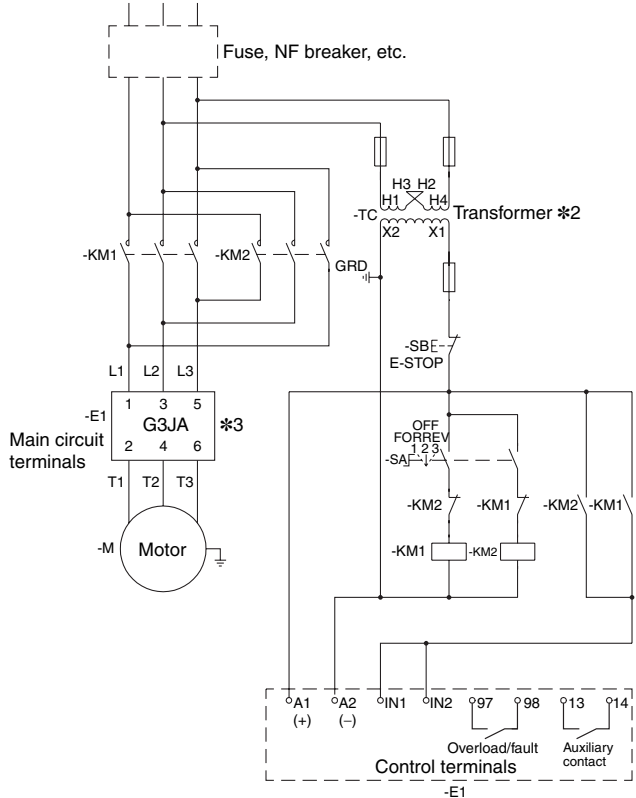

Operation Chart: Two-wire Connections with Forward/Reverse Rotation

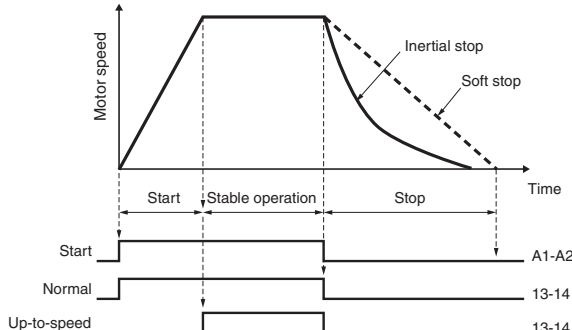

- *1. This transformer is used to convert the load voltage into the control voltage of the G3JA. A transformer is not required if the load voltage is within the rated operational voltage range of the G3JA.
- *2. The wiring in the following diagram is used for a 3-phase, 6-wire motor (Delta).

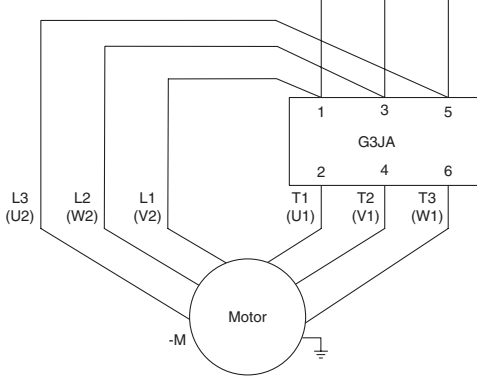

Operation

■ Operating Modes

Soft Start

A soft start is used to reduce mechanical shock when starting the motor. The motor voltage is increased from the initial torque to full voltage.

The initial torque can be set to 15%, 25%, 35%, or 65% of the locked rotor torque. The motor voltage is gradually increased during the acceleration ramp time. The acceleration ramp time can be set to 2 s, 5 s, 10 s, 15 s, 20 s, 25 s, or 30 s. The bypass relay turns ON after the motor starts.

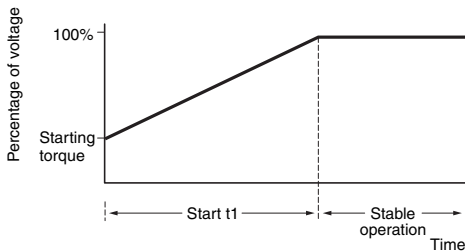

Current Limit Start

This start mode is used when the maximum starting current must be limited. During the start time, the thyristor will reduce the motor terminal voltage to limit the current at startup. During stable operation, the built-in bypass relay will be ON.

The current limit can be set to 150%, 250%, 350%, or 450% of the full-load current. The start time can be set to 2 s, 5 s, 10 s, 15 s, 20 s, 25 s, or 30 s.

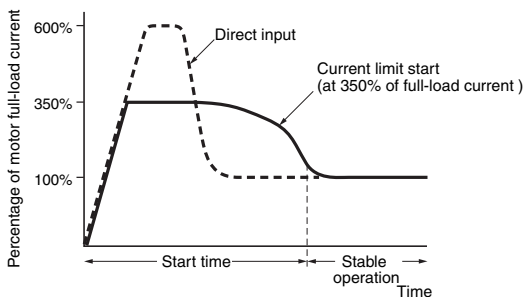

Kick Start

A kick start, or boost, at the beginning of the start mode provides a current pulse of 450% of the full-load current. The kick start time can be set to OFF, 0.5 s, 1 s, or 1.5 s. This allows the motor to develop additional torque at start for loads which may need a boost to get started.

Some loads that may not start well in soft start mode will start more smoothly if the kick start is enabled to provide more rotational torque to the motor. Increase the kick start time one step at a time to gradually increase the initial torque.

The current will increase temporarily during the kick start, but the start mode that was selected will continue after the kick start has been completed.

When the current limit start function has been enabled, the kick start will be disabled.

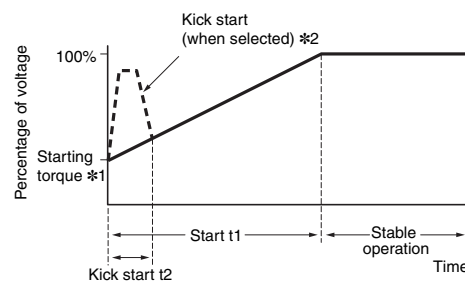

Note: Refer to *DIP Switch Settings* on page 11 for details.

*1. Initial Torque Setting for Soft Start

*2. Kick Start

Soft Stop

A soft stop is used with applications that require an extended coast to stop. When enabled, the voltage ramp down time can be set to one, two, or three times the start time. The motor will stop when the motor voltage drops to the point where the load torque is greater than the motor torque.

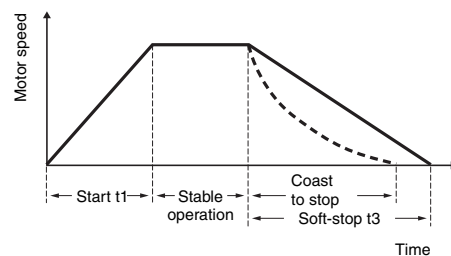

Start Time for a Soft Start or Current Limit Start

A built-in current transformer (CT) is used to detect the motor current. The completion of motor startup is determined by detecting the convergence of the current as the speed of the motor increases. The Soft Starter operation is then changed to stable operation. The start time given here is a guideline for when the total load current set on the overload FLA setting dial and the actual load current are the same. If the motor load is smaller, the motor will start faster, so that actual start time will be shorter than the start time given here.

Soft Stop Time

The soft stop function gradually reduces the motor voltage to prevent the motor from stopping suddenly under a large load. A built-in CT is used to detect the motor current and size of the current is used to determine the size of the load and the rate at which the voltage is reduced. If the motor load is extremely small, the soft stop time will be very short.

■ Description of Functions

Overload Protection

The G3JA-C is equipped with overload protection. The overload class can be set to OFF, 10, 15, or 20. Either automatic or manual mode can be used to reset an overload (trip). Set the trip current to the rated full-load current of the motor through the overload FLA setting dial. When an overload fault occurs, the G3JA-C indicates the overload with a flashing LED indicator and closes the alarm contact.

After an error is detected, the SCR will become hot, and an overtemperature fault may also be detected. If it is, pushing the reset button will not reset the system. Resetting will be possible once the temperature of the SCR has decreased. Wait about two minutes to allow the SCR to cool (assuming the ambient temperature is normal).

Overtemperature

The G3JA-C monitors the SCR temperature through an internal thermistor. If the SCR gets too hot, the G3JA-C turns OFF the output, indicates the overtemperature status with a flashing LED, and closes the alarm contact. Pushing the reset button will not reset the system. Resetting will be possible once the temperature of the SCR has decreased. Wait about two minutes to allow the SCR to cool (assuming the ambient temperature is normal).

Phase Reversal Protection

When this function is enabled with a DIP switch setting, the G3JA-C checks phase sequence prior to startup. If the G3JA-C detects a phase reversal fault in the main circuit power supply, it stops the starting sequence, indicates the phase reversal with a flashing LED indicator, and closes the alarm contact.

Phase Loss

The G3JA-C monitors phase loss. If phase loss lasts for two power supply frequency cycles, the G3JA-C turns OFF the output, indicates the phase loss with a flashing LED indicator and closes the alarm contact.

Current Imbalance

The G3JA-C monitors the phase current imbalance. If the imbalance exceeds the preset limit, the G3JA-C turns OFF the output, indicates the current imbalance with a flashing LED indicator and closes the alarm contact.

Shorted SCR

The G3JA-C always checks the SCR for a short circuit before the starting sequence. If a short circuit is found, the G3JA-C stops the starting sequence, indicates the short circuit with a flashing LED indicator, and closes the alarm contact.

Nomenclature

Part Names and Functions

Upgraded Models

Production of a new version of the Soft Starter (version 2) with added functions was started in August 2008. The DIP switch settings of the new version are different from the previous version. For details, refer to *Upgrades for Version 2* on page 13.

DIP Switch Configuration

Use the DIP switch to set the functions.

DIP switch pin	Function
1	Start time
2	
3	Start mode (current limit start or soft start)
4	Current limit start setting (when selected) or initial torque setting for a soft start (when selected)
5	
6	Soft stop
7	
8	Long time setting for start time
9	Kick start
10	
11	Overload class selection
12	
13	Overload reset
14	Auxiliary/optional auxiliary contact (normal/up-to-speed)
15	Motor wiring (Line or Delta)
16	Phase reversal protection

Main Circuit Terminals, Power Supply Side

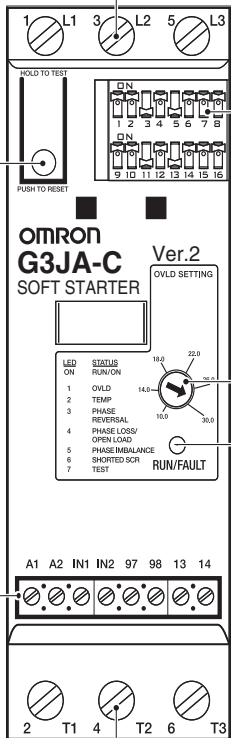

Reset Button

All faults can be reset by pressing the Reset Button or turning OFF the control power supply. Cooling time may be required before overload and overtemperature status can be reset.

Note: Test Mode for overload testing will be entered when the Reset Button is pressed for approximately seconds. Test Mode will be cancelled when the Reset Button is pressed again.

Control Terminals

The G3JA-C has eight input terminals on the front. Each terminal is described in the following table.

Terminal	Description
A1	Control power supply input
A2	Control power supply common
IN1	START input
IN2	STOP input
97	NO auxiliary contact (auxiliary contact for fault detection output)
98	NO auxiliary contact (auxiliary contact for fault detection output)
13	NO auxiliary contact (normal/up-to-speed)
14	NO auxiliary contact (normal/up-to-speed)

Auxiliary Contacts

The G3JA-C is equipped with two auxiliary contacts as a standard feature. One contact can be used for fault detection output. The other one is used to output operating status and can be set to either *Normal* or *Up-to-speed* using the DIP switch setting at pin number 14.

An optional Auxiliary Contact Block can be added, and DIP switch pin number 14 can be used to set the operating status to output (either *Normal* or *Set Speed*).

Overload FLA Setting Dial

Use this dial to set the trip current to the rated full-load current of the motor. If the setting is not correct, it will not be possible to drive the motor properly.

For a 3-phase, 6-wire motor, use the following formula to calculate the dial setting.

$$\text{Set value} = \text{Total motor load current} / 1.73$$

For example, if the total motor load current is 20 A, the dial setting is 11.6 A (20 A/1.73).

RUN/FAULT Indicator

The G3JA-C monitors the status before startup and during operation. One indicator indicates both normal operation (RUN) and faults (FAULT). If the G3JA-C detects a fault, it turns OFF the motor and indicates the fault with a flashing LED indicator.

The G3JA-C monitors the following conditions.

Fault	Flashing indicator status
Overload	[Flashing indicator status diagram]
Over-temperature	[Flashing indicator status diagram]
Phase reversal	[Flashing indicator status diagram]
Phase loss	[Flashing indicator status diagram]
Current imbalance	[Flashing indicator status diagram]
Shorted SCR	[Flashing indicator status diagram]

Note: The indicator will flash seven times in test mode (trip test).

Main Circuit Terminals, Load Side

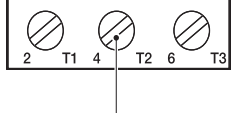

■ DIP Switch Settings

Start Time t1

DIP switch pins			Time (seconds)
1	2	3	
OFF	OFF	OFF	2
ON	OFF	OFF	5
OFF	ON	OFF	10
ON	ON	OFF	15
OFF	OFF	ON	20
ON	OFF	ON	25
OFF	ON	ON	30

Start Mode (Current Limit Start or Soft Start)

DIP switch pin pins3	Setting
ON	Soft start
OFF	Current limit start

Initial Torque Setting for Soft Start

DIP switch pins		LRT initial torque (%)
4	5	
OFF	OFF	15%
ON	OFF	25%
OFF	ON	35%
ON	ON	65%

Current Limit Start Setting

DIP switch pins		FLA current limit (%)
4	5	
OFF	OFF	150%
ON	OFF	250%
OFF	ON	350%
ON	ON	450%

Soft Stop t3

DIP switch pins		Setting
6	7	
OFF	OFF	Coast to stop
ON	OFF	100% of the start time
OFF	ON	200% of the start time
ON	ON	300% of the start time

Kick Start t2

DIP switch pins		Time (seconds)
9	10	
OFF	OFF	OFF
ON	OFF	0.5
OFF	ON	1.0
ON	ON	1.5

*Set Kick Start to OFF if the G3JA is used with a Current Limit Start.

Overload Class Selection

DIP switch pins		Overload class
11	12	
OFF	OFF	OFF
ON	OFF	10
OFF	ON	15
ON	ON	20

Overload Reset

DIP switch pin 13	Reset
ON	Automatic
OFF	Manual

Phase Reversal Protection

DIP switch pin 16	Setting
ON	Disabled
OFF	Enabled

Auxiliary Contacts and Optional Auxiliary Contact Block

DIP switch pin 14	Auxiliary contacts (13 to 14)	Optional Auxiliary Contact Block (23 to 24)
ON	Up-to-speed	Normal
OFF	Normal	Up-to-speed

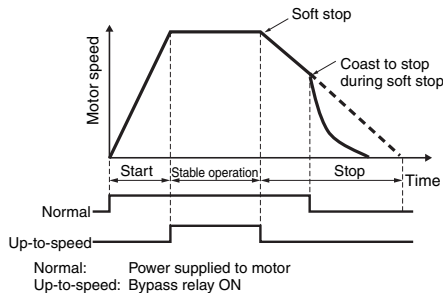

Motor Wiring

DIP switch pin 15	Motor wiring
ON	Line
OFF	Delta

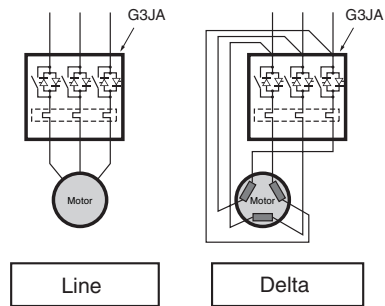

■ Engineering Data

Trip Curves

Trip Class 10

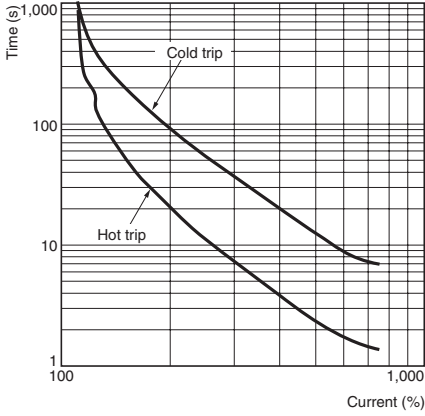

Trip Class 15

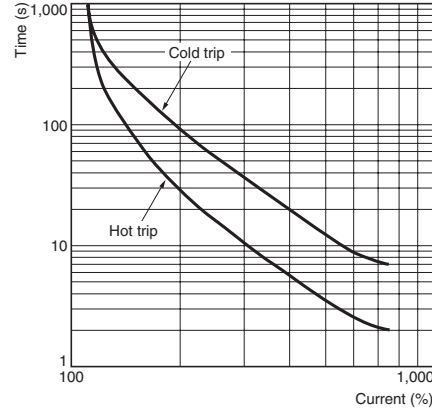

Trip Class 20

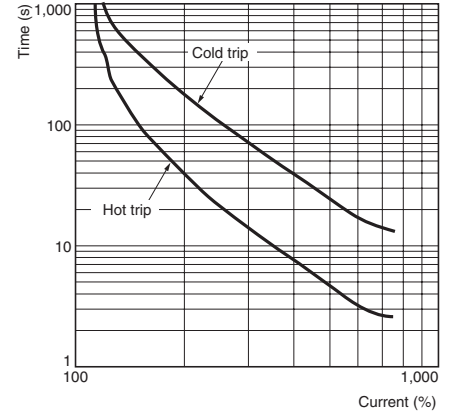

■ Dimensions

(Unit: mm)

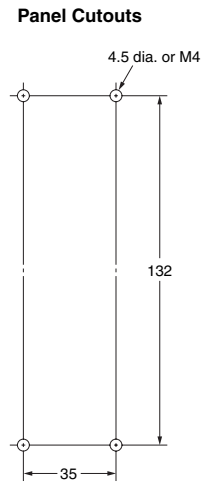
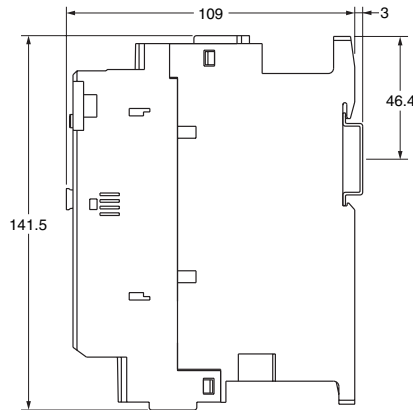
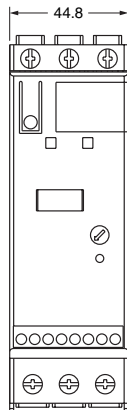
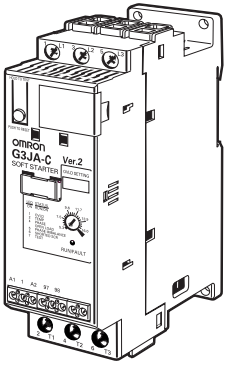

Note: All models are the same size regardless of the capacity.

Mounting Dimensions for the Auxiliary Contact Block and Round Terminal Block Adapter

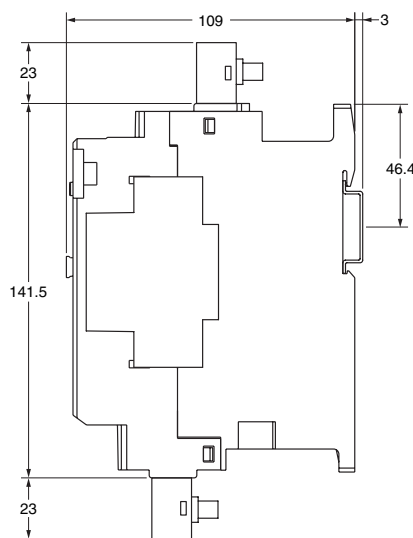
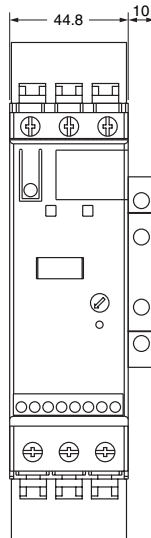
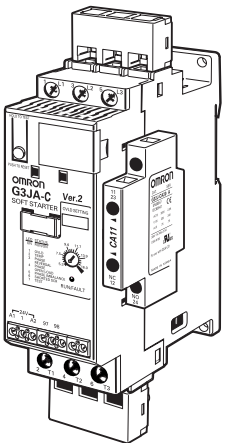

Upgrades for Version 2

■ Upgrades

- Control of 3-phase, 6-wire motors (star-delta wiring) is supported.
- The soft start time can be set to up to 30 s.

■ Identifying Upgraded Models

You can check whether the G3JA is an upgraded version by the markings on the G3JA or the label on the box. If the G3JA is not marked "Ver. 2," it is the previous version.

Markings on Unit



Label on Box



■ Previous Version

The DIP switch settings are different for the upgraded version (version 2) and the previous version.

Refer to the following tables for compatibility.

Comparison of Functions

Item	Previous version	New version (version 2)
1. 3-phase, 6-wire motors (Delta)	Control not possible.	Control possible.
2. Soft start time settings	2, 5, 10, or 15 s	2, 5, 10, 15, 20, 25, or 30 s

Comparison of DIP Switch Settings

DIP switch pin	Previous version	New version (version 2)
1	Start time	Start time
2	Start mode (current limit start or soft start)	Start mode (current limit start or soft start)
3		
4	Current limit start setting (when selected) or initial torque setting for a soft start (when selected)	Current limit start setting (when selected) or initial torque setting for a soft start (when selected)
5		
6	Soft stop	Soft stop
7		
8 *	Not used	Long time setting for start time
9	Kick start	Kick start
10		
11	Trip class selection	Trip class selection
12		
13	Overload (trip) reset	Overload (trip) reset
14 *	Auxiliary contact (normal/up-to-speed)	Auxiliary contact or Optional Auxiliary Contact Block (normal/up-to-speed)
15 *	Optional Auxiliary Contact Block (normal/up-to-speed)	Motor wiring (Line or Delta)
16	Phase reversal protection	Phase reversal protection

*These settings are different for the previous version and the new version.

Comparison of DIP Switch Setting Differences

1. Start Time

Previous version				New version (version 2)			
DIP switch pins			Time (unit: s)	DIP switch pins			Time (unit: s)
1	2	8		1	2	8	
OFF	OFF	Not used	2	OFF	OFF	OFF	2
ON	OFF		5	ON	OFF	OFF	5
OFF	ON		10	OFF	ON	OFF	10
ON	ON		15	ON	ON	OFF	15
---				OFF	OFF	ON	20
---				ON	OFF	ON	25
---				OFF	ON	ON	30

2. Auxiliary Contact and Optional Auxiliary Contact Block (New Version)

Auxiliary Contact (Previous Version)

Previous version		New version (version 2)		
DIP switch pin 14	Auxiliary contacts (13 to 14)	DIP switch pin 14	Auxiliary contacts (13 to 14)	Optional Auxiliary Contact Block (23 to 24)
ON	Up-to-speed	ON	Up-to-speed	Normal
OFF	Normal	OFF	Normal	Up-to-speed

Note: With the new version, it is not possible to individually set the auxiliary contacts (13 to 14) and Optional Auxiliary Contact Block (23 to 24).

3. Motor Wiring Method (New Version)

Optional Auxiliary Contact Block (Previous Version)

Previous version		New version (version 2)	
DIP switch pin 15	Optional Auxiliary Contact Block (23 to 24)	DIP switch pin 15	Motor wiring
ON	Up-to-speed	ON	3-phase, 3-wire motor (Line)
OFF	Normal	OFF	3-phase, 6-wire motor (Delta)

■ Accessories (Order Separately)

Auxiliary Contact Blocks

- G32J-CA10
- G32J-CA20
- G32J-CA01
- G32J-CA11

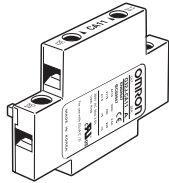

Mounting

1. Insert the connector and hooks on the Auxiliary Contact Block (G32J-CA) into the mounting holes of the G3JA. When doing so, be careful that the connector terminals do not bend.
2. Press down on the Auxiliary Contact Block in the direction of arrow 2 in the figure until you hear a click.
3. To wire the Auxiliary Contact Block, use sheathed wire (length of stripped wire: 9 mm) with a core thickness of 0.5 to 2.5 mm² (AWG18 to AWG14). Use a tightening torque of 1.0 to 1.1 N·m.

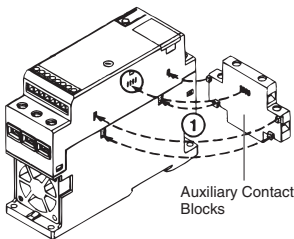

Removing

1. Gradually pull out the connector on the top part of the Auxiliary Contact Block (G32J-CA) in the direction of arrow 1 in the figure.
2. Pull the Auxiliary Contact Block in the direction of arrow 2 in the figure.
3. Pull the Auxiliary Contact Block in the direction of arrow 3 in the figure and remove it.

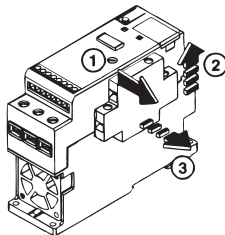

Contacts	Contact form	Model
1NO	23 ——— 24	G32J-CA10
2NO	33 ——— 34 23 ——— 24	G32J-CA20
1NC	11 ——— 12	G32J-CA01
1NO/1NC	11 ——— 12 23 ——— 24	G32J-CA11

Specifications

Item	Specifications
Control circuit method	Electromagnetic relay
Current specifications	AC/DC
Rated operating current	2.5 A, 300 VAC

Fan

G32J-CF64

It is possible to perform switching four times per hour without a fan if the G3JA is used at the rated current in an ambient temperature of 50°C max. with a sine current of 300%, a start time of 15 s, and an ON time ratio of 70% max. If a fan is used, switching can be performed ten times per hour under the same conditions.

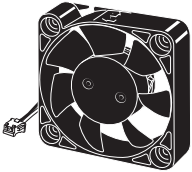

Mounting

1. Mount the fan so that the arrow on the surface of the Fan (G32J-CF64) is in the direction shown in the figure.
2. Insert the fan connector into the G3JA connector until it clicks into place.
3. Mount the fan on the G3JA.

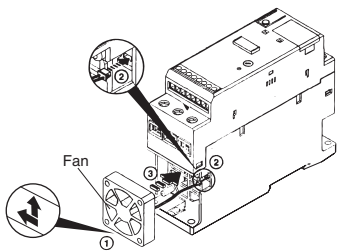

Round Terminal Block Adaptor

G32J-TA10

This is a terminal block adaptor for wiring with round crimp terminals.

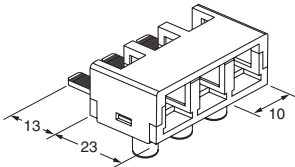

Mounting

Once the Terminal Block Adaptor for Round Terminals is wired, mount it to the main circuit terminals of the G3JA. If wiring is performed after mounting the Terminal Block Adaptor for Round Terminals on the G3JA, tighten the screws again on the main terminals of the G3JA and the Terminal Block Adaptor to the specified tightening torque once wiring is completed.

Note: 1. The Round Terminal Block Adaptor (G32J-TA10) is delivered with the cover removed.

2. The mounting strength of the cover on the Round Terminal Block Adaptor has been increased to prevent it from becoming removed or falling off.

Remove the cover by inserting a flat-head screwdriver into the cover bump on the back of the Round Terminal Block Adaptor and making a gap. Be careful not to become injured when removing the cover.

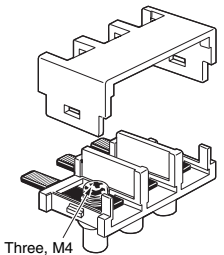

3. Tighten the screws to the specified torque. The tightening torque for mounting the Round Terminal Block Adaptor to the G3JA is 2.3 to 3.4 N·m. The tightening torque for wiring the Round Terminal Block Adaptor to G3JA is 0.98 to 1.37 N·m.

Safety Precautions

Refer to *Safety Precautions for All Solid State Relays*.

CAUTION

Installation and Environment

Always turn OFF the power supply if there is a possibility that the terminals may be touched. Not doing so may occasionally result in minor electric shock.



Firmly tighten the screws to the specified torque. If the screws are not firmly tightened, minor fires may occasionally occur. Refer to *Specifications* and *Accessories (Order Separately)* for details.



Maintenance

The charge of the electrolytic capacitor used in the internal circuit may occasionally result in minor electric shock. Before touching the terminals, turn OFF the power supply and make sure that the voltage has been eliminated due to discharge.



Precautions for Safe Use

Operation and Storage Locations

- Do not use or store the SSR in the following locations. Doing so may result in damage, malfunction, or deterioration of performance characteristics.
 - Locations subject to excessive shock or vibration
 - Locations subject to exposure to water, oil, or chemicals
 - Usage locations subject to ambient temperatures outside the range of 0°C to 50°C
 - Storage locations subject to ambient temperatures outside the range of -25°C to 85°C
 - Usage locations subject to humidity outside the range of 5% to 85% or to condensation due to sudden temperature change
 - Locations subject to corrosive or flammable gases
 - Locations subject to excessive dust, salinity, or metal powder.

Installation

- Do not drop the product or subject it to abnormal vibration or shock. Doing so may result in failure or malfunction.
- Do not install the product if your hands are dirty with oil or metal dust. Doing so may result in failure.

Installation and Handling

- The product is heavy. Firmly mount it on a DIN Track. Also securely mount the DIN Track.
- Mount the product in the specified mounting direction. Abnormal heat radiation from the Unit will result in SCR failure or damage.

Installation and Wiring

- Make sure that all lead wires are appropriate for the load current. Abnormal heat radiation from the wires may result in burning.
- Do not use wires with a damaged sheath. Doing so may result in electric shock or current leakage.
- Do not wire power lines or high-tension lines along with the control circuit lines in the same conduit or duct. Doing so may result in damage or malfunction due to induction.
- Use wires of an appropriate length. Wires of improper length may result in malfunction or burning due to induction.
- Connect to the primary side (i.e., power supply side) of the G3JA output terminals if you use a power capacitor.

Installation and Use

- If two or more Units are used with close mounting, it is recommended to install them with a gap of approximately 5 mm between Units. (No gap is required for Auxiliary Contact Units.)

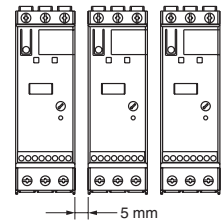

If close mounting is used, also take into account the increase in ambient temperature due to heat dissipated by the Units themselves. In particular, use fans for sufficient ventilation with external air if the Units are mounted inside a panel.

- Do not use the product with loads greater than the rated current. Doing so will result in abnormal heat radiation.
- For protection against grounding accidents, always install a fuse, breaker, or other protective device on the power supply side.
- Select a power supply that is in the rated frequencies. Not doing so will result in malfunction, failure, or burning.

Precautions for Correct Use

Altitude Derating

The rated current of the G3JA must be decreased at altitudes above 2,000 m because of decreased efficiency of the heat sink and fan (G32J-CF64).

Warning Labels Included with Product

If voltage is applied to the main circuit power supply side of the G3JA, there will be voltage in the terminals on the main circuit load side even if the G3JA is OFF. Be sure to use the warning labels included with the product to provide notification of this hazard on locations such as the motor terminal box, G3JA, and control panel.

Main Circuit Cutoff at Error

Safety is further improved by turning OFF the contacts and other lines on the main circuit power supply side of the G3JA as shown in the following figure. For a wiring example, refer to *Examples: Main Circuit Fault Shutoff*.

Standard Connection Diagram for Main Circuit Cutoff at Error

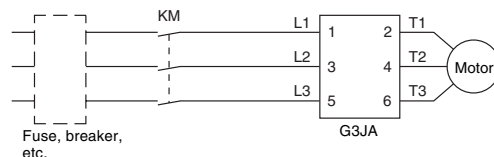

Connecting Varistors

The G3JA will be damaged by overvoltage if high-energy surge voltage builds up in the AC power supply that is used. If surge voltage is a problem, connect three varistors with one on each phase in the position shown in the following figure. The following varistor is recommended. Also, when you connect the varistor, always install a fuse, breaker, or other protective device on the power supply side of the varistor.

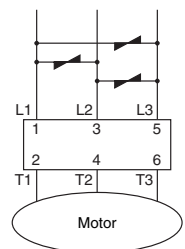

Varistor voltage: 910 V

Energy resistance: 200 joules min. (10 × 1000 μs)

Limiting Resistor

The G3JA cannot use a limiting resistor.

Operation Start Signal

Do not apply an operation start signal during a soft stop. Doing so will result in abnormal operation.

Connecting a Power Capacitor

If you use a power capacitor, connect it to the primary side (i.e., power supply side) of the G3JA output terminals.

ALL DIMENSIONS SHOWN ARE IN MILLIMETERS.

To convert millimeters into inches, multiply by 0.03937. To convert grams into ounces, multiply by 0.03527.

In the interest of product improvement, specifications are subject to change without notice.

Read and Understand This Catalog

Please read and understand this catalog before purchasing the products. Please consult your OMRON representative if you have any questions or comments.

Warranty and Limitations of Liability

WARRANTY

OMRON's exclusive warranty is that the products are free from defects in materials and workmanship for a period of one year (or other period if specified) from date of sale by OMRON.

OMRON MAKES NO WARRANTY OR REPRESENTATION, EXPRESS OR IMPLIED, REGARDING NON-INFRINGEMENT, MERCHANTABILITY, OR FITNESS FOR PARTICULAR PURPOSE OF THE PRODUCTS. ANY BUYER OR USER ACKNOWLEDGES THAT THE BUYER OR USER ALONE HAS DETERMINED THAT THE PRODUCTS WILL SUITABLY MEET THE REQUIREMENTS OF THEIR INTENDED USE. OMRON DISCLAIMS ALL OTHER WARRANTIES, EXPRESS OR IMPLIED.

LIMITATIONS OF LIABILITY

OMRON SHALL NOT BE RESPONSIBLE FOR SPECIAL, INDIRECT, OR CONSEQUENTIAL DAMAGES, LOSS OF PROFITS OR COMMERCIAL LOSS IN ANY WAY CONNECTED WITH THE PRODUCTS, WHETHER SUCH CLAIM IS BASED ON CONTRACT, WARRANTY, NEGLIGENCE, OR STRICT LIABILITY.

In no event shall the responsibility of OMRON for any act exceed the individual price of the product on which liability is asserted.

IN NO EVENT SHALL OMRON BE RESPONSIBLE FOR WARRANTY, REPAIR, OR OTHER CLAIMS REGARDING THE PRODUCTS UNLESS OMRON'S ANALYSIS CONFIRMS THAT THE PRODUCTS WERE PROPERLY HANDLED, STORED, INSTALLED, AND MAINTAINED AND NOT SUBJECT TO CONTAMINATION, ABUSE, MISUSE, OR INAPPROPRIATE MODIFICATION OR REPAIR.

Application Considerations

SUITABILITY FOR USE

OMRON shall not be responsible for conformity with any standards, codes, or regulations that apply to the combination of products in the customer's application or use of the products.

At the customer's request, OMRON will provide applicable third party certification documents identifying ratings and limitations of use that apply to the products. This information by itself is not sufficient for a complete determination of the suitability of the products in combination with the end product, machine, system, or other application or use.

The following are some examples of applications for which particular attention must be given. This is not intended to be an exhaustive list of all possible uses of the products, nor is it intended to imply that the uses listed may be suitable for the products:

- Outdoor use, uses involving potential chemical contamination or electrical interference, or conditions or uses not described in this catalog.
- Nuclear energy control systems, combustion systems, railroad systems, aviation systems, medical equipment, amusement machines, vehicles, safety equipment, and installations subject to separate industry or government regulations.
- Systems, machines, and equipment that could present a risk to life or property.

Please know and observe all prohibitions of use applicable to the products.

NEVER USE THE PRODUCTS FOR AN APPLICATION INVOLVING SERIOUS RISK TO LIFE OR PROPERTY WITHOUT ENSURING THAT THE SYSTEM AS A WHOLE HAS BEEN DESIGNED TO ADDRESS THE RISKS, AND THAT THE OMRON PRODUCTS ARE PROPERLY RATED AND INSTALLED FOR THE INTENDED USE WITHIN THE OVERALL EQUIPMENT OR SYSTEM.

PROGRAMMABLE PRODUCTS

OMRON shall not be responsible for the user's programming of a programmable product, or any consequence thereof.

Disclaimers

CHANGE IN SPECIFICATIONS

Product specifications and accessories may be changed at any time based on improvements and other reasons.

It is our practice to change model numbers when published ratings or features are changed, or when significant construction changes are made. However, some specifications of the products may be changed without any notice. When in doubt, special model numbers may be assigned to fix or establish key specifications for your application on your request. Please consult with your OMRON representative at any time to confirm actual specifications of purchased products.

DIMENSIONS AND WEIGHTS

Dimensions and weights are nominal and are not to be used for manufacturing purposes, even when tolerances are shown.

PERFORMANCE DATA

Performance data given in this catalog is provided as a guide for the user in determining suitability and does not constitute a warranty. It may represent the result of OMRON's test conditions, and the users must correlate it to actual application requirements. Actual performance is subject to the OMRON Warranty and Limitations of Liability.

ERRORS AND OMISSIONS

The information in this document has been carefully checked and is believed to be accurate; however, no responsibility is assumed for clerical, typographical, or proofreading errors, or omissions.

2011.5

In the interest of product improvement, specifications are subject to change without notice.

OMRON Corporation
Industrial Automation Company

<http://www.ia.omron.com/>

(c)Copyright OMRON Corporation 2011 All Right Reserved.