

MAZ2000 Series (MA2000 Series)

Silicon planar type

For stabilization of power supply

■ Features

- High reliability, achieved by the combination the planar type and the glass seal
- Large power dissipation: $P_D = 1\text{ W}$
- Wide voltage range: $V_Z = 5.1\text{ V}$ to 56.0 V
- Easy-to-use because of the finely divided zener voltage ranks, such as A and B ranks

■ Absolute Maximum Ratings $T_a = 25^\circ\text{C}$

Parameter	Symbol	Rating	Unit
Repetitive peak forward current	I_{FRM}	400	mA
Total power dissipation *1	P_{tot}	1	W
Non-repetitive reverse surge power dissipation *2	P_{ZSM}	75	W
Junction temperature	T_j	200	$^\circ\text{C}$
Storage temperature	T_{stg}	-55 to +200	$^\circ\text{C}$

Note) *1: With a printed circuit board

*2: $t = 100\ \mu\text{s}$, $T_j = 150^\circ\text{C}$

■ Common Electrical Characteristics $T_a = 25^\circ\text{C}$ *1

Parameter	Symbol	Conditions	Min	Typ	Max	Unit
Forward voltage	V_F	$I_F = 200\text{ mA}$			1	V
Zener voltage *2	V_Z	I_Z Specified value				V
Zener operating resistance	R_Z	I_Z Specified value				Ω
Reverse current	I_R	V_R Specified value				μA
Temperature coefficient of zener voltage *3	S_Z	I_Z Specified value				$\text{mV}/^\circ\text{C}$
Terminal capacitance	C_t	V_R Specified value				pF

Refer to the list of the electrical characteristics within part numbers

Note) 1 .Rated input/output frequency: 5 MHz

2 *1: The V_Z value is for the temperature of 25°C . In other cases, carry out the temperature compensation.

*2: Guaranteed at 20 ms after power application.

*3: $T_j = 25^\circ\text{C}$ to 150°C

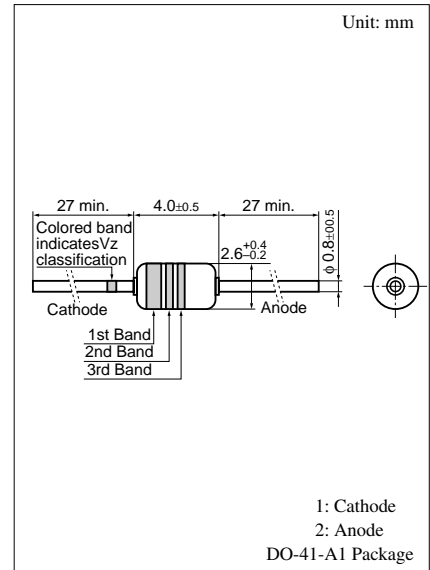

• Color indication of V_Z rank classification

Rank	A	B
Color	Blue	Red

Note) The part number in the parenthesis shows conventional part number.

■ Electrical characteristics within part numbers $T_a = 25^\circ\text{C}$

Part Number	Zener voltage			Reverse current		Zener operating resistance		Temperature coefficient of zener voltage		Terminal capacitance C_T (pF) ($V_R = 0$ V) $f = 1$ MHz Typ	Marking symbol (Color indication)			
	V_Z (V)			I_R (μA)		R_Z (Ω)		S_Z (mV/ $^\circ\text{C}$)			C_T (pF) ($V_R = 0$ V) $f = 1$ MHz Typ	1st.	2nd.	3rd.
	I_Z (mA)	Min	Nom	Max	V_R (V)	Max	I_Z (mA)	Max	I_Z (mA)	Typ				
MAZ2051	40	4.8	5.1	5.4	1	20	40	10	40	0	200	Green	Brown	Brown
MAZ20510A		4.8	—	5.15										
MAZ20510B		5.05	—	5.4										
MAZ2056	40	5.2	5.6	6.0	2	20	40	8	40	1.5	180	Green	Blue	Blue
MAZ20560A		5.3	—	5.7										
MAZ20560B		5.6	—	6.0										
MAZ2062	40	5.8	6.2	6.6	3	20	40	6	40	2.4	330	Blue	Red	Red
MAZ20620A		5.8	—	6.2										
MAZ20620B		6.1	—	6.5										
MAZ2068	40	6.4	6.8	7.2	3	10	40	6	40	3.1	280	Blue	Gray	Gray
MAZ20680A		6.4	—	6.8										
MAZ20680B		6.7	—	7.1										
MAZ2075	40	7.0	7.5	7.9	3	10	40	5	40	3.8	250	Purple	Green	Green
MAZ20750A		7.0	—	7.45										
MAZ20750B		7.35	—	7.8										
MAZ2082	40	7.7	8.2	8.7	4	10	40	5	40	4.5	230	Gray	Red	Red
MAZ20820A		7.7	—	8.2										
MAZ20820B		8.1	—	8.6										
MAZ2091	40	8.5	9.1	9.6	5	10	40	6	40	5.4	220	White	Brown	Brown
MAZ20910A		8.5	—	9.05										
MAZ20910B		8.95	—	9.5										
MAZ2100	40	9.4	10.0	10.6	7	10	40	6	40	6.3	200	Brown	Black	—
MAZ21000A		9.4	—	10										
MAZ21000B		9.9	—	10.5										
MAZ2110	20	10.4	11.0	11.6	7	5	20	8	20	7.4	160	Brown	Brown	—
MAZ21100A		10.4	—	11.05										
MAZ21100B		10.85	—	11.5										
MAZ2120	20	11.4	12.0	12.7	8	5	20	8	20	8.4	160	Brown	Red	—
MAZ21200A		11.4	—	12.1										
MAZ21200B		11.9	—	12.6										
MAZ2130	20	12.4	13.0	14.1	9	5	20	10	20	9.4	155	Brown	Orange	—
MAZ21300A		12.4	—	13.25										
MAZ21300B		13.15	—	14.0										
MAZ2150	20	13.8	15.0	15.6	10	5	20	12	20	11.4	150	Brown	Green	—
MAZ21500A		13.8	—	14.7										
MAZ21500B		14.5	—	15.4										
MAZ2160	20	15.3	16.0	17.1	11	5	20	12	20	12.5	135	Brown	Blue	—
MAZ21600A		15.3	—	16.3										
MAZ21600B		16.1	—	17.1										
MAZ2180	20	16.8	18.0	19.1	12	5	20	15	20	14.5	110	Brown	Gray	—
MAZ21800A		16.8	—	18.0										
MAZ21800B		17.8	—	19.0										
MAZ2200	20	18.8	20.0	21.2	14	5	20	15	20	16.6	100	Red	Black	—
MAZ22000A		18.8	—	20.0										
MAZ22000B		19.8	—	21.0										

■ Electrical characteristics within part numbers (continued) $T_a = 25^\circ\text{C}$

Part number	Zener voltage			Reverse current		Zener operating resistance		Temperature coefficient of zener voltage		Terminal capacitance C_t (pF) ($V_R = 0$ V) $f = 1$ MHz Typ	Marking symbol (Color indication)			
	V_Z (V)			I_R (μA)		R_Z (Ω)		S_Z (mV/ $^\circ\text{C}$)			1st.	2nd.	3rd.	
	I_Z (mA)	Min	Nom	Max	V_R (V)	Max	I_Z (mA)	Max	I_Z (mA)	Typ				
MAZ2220	10	20.8	22.0	23.3	15	5	10	20	10	18.6	95	Red	Red	—
MAZ22200A		20.8	—	22.15										
MAZ22200B		21.85	—	23.2										
MAZ2240	10	22.8	24.0	25.6	16	5	10	20	10	20.7	90	Red	Yellow	—
MAZ22400A		22.8	—	24.35										
MAZ22400B		24.15	—	25.6										
MAZ2270	10	25.1	27.0	28.9	18	2	10	25	10	23.8	85	Red	Purple	—
MAZ22700A		25.1	—	27.0										
MAZ22700B		26.9	—	28.9										
MAZ2300	10	28.0	30.0	32.0	20	2	10	25	10	26.9	80	Orange	Black	—
MAZ23000A		28.0	—	30.1										
MAZ23000B		29.9	—	32.0										
MAZ2330	10	31.0	33.0	35.0	22	2	10	30	10	30.0	75	Orange	Orange	—
MAZ23300A		31.0	—	33.14										
MAZ23300B		32.86	—	35.0										
MAZ2360	10	34.0	36.0	38.0	24	2	10	30	10	33.4	70	Orange	Blue	—
MAZ23600A		34.0	—	36.16										
MAZ23600B		35.84	—	38.0										
MAZ2390	10	37.0	39.0	41.0	26	5	10	50	10	36.3	65	Orange	White	—
MAZ2430	10	40.0	43.0	46.0	29	5	10	50	10	41.1	60	Yellow	Orange	—
MAZ2470	10	44.0	47.0	50.0	31	5	10	50	10	44.9	55	Yellow	Purple	—
MAZ2510	10	48.0	51.0	54.0	33	5	10	50	10	48.6	50	Green	Brown	—
MAZ2560	10	52.0	56.0	60.0	35	5	10	50	10	54.9	45	Green	Blue	—

- Note) 1. The V_Z value is the one after power application for 20 ms at $T_a = 25^\circ\text{C}$.
 2. The zener voltage temperature coefficient is the one for $T_j = 25^\circ\text{C}$ to 150°C .

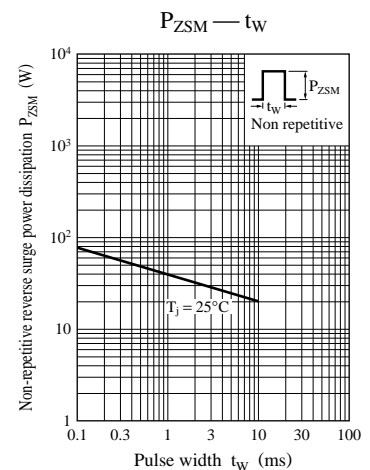
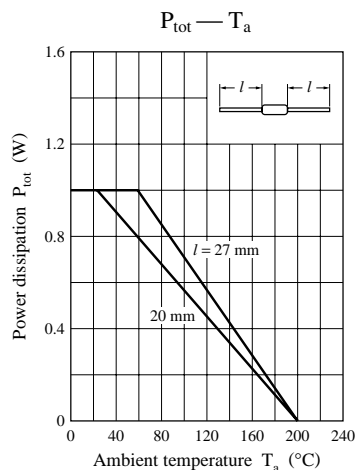
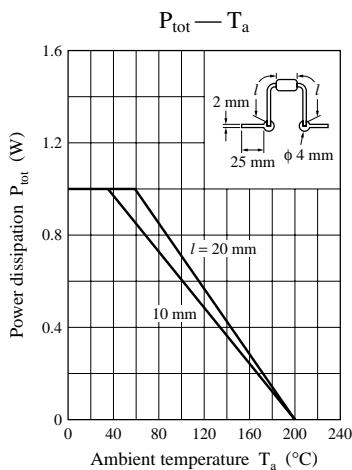

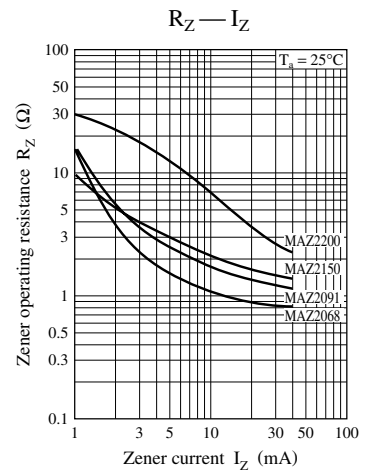
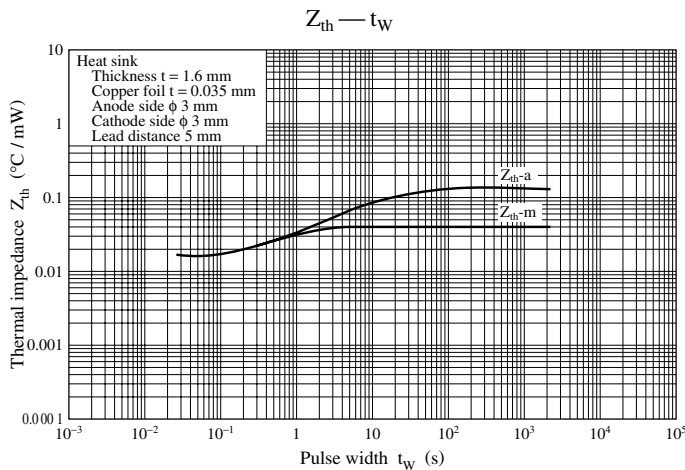
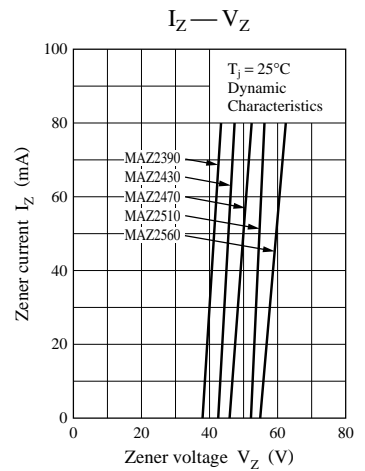
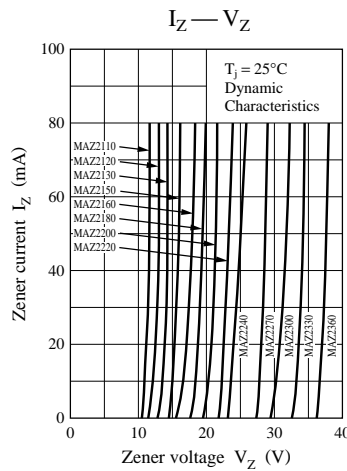
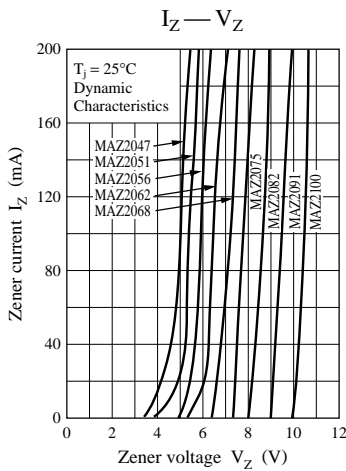
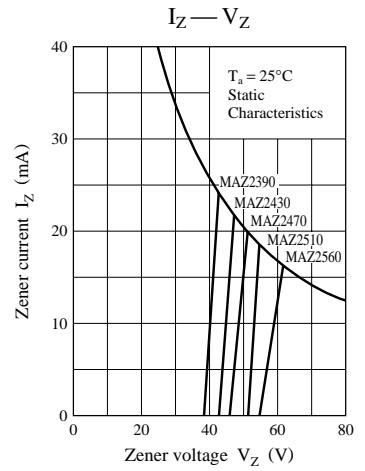
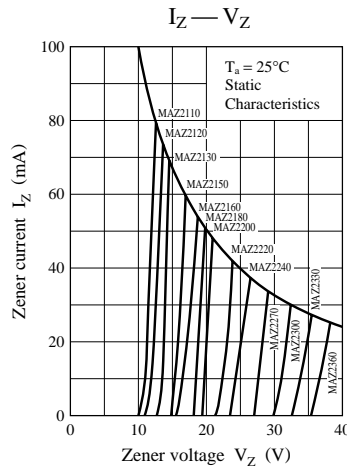
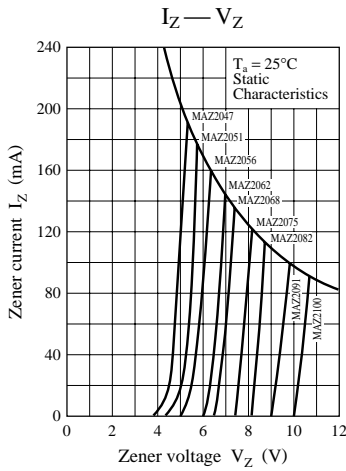

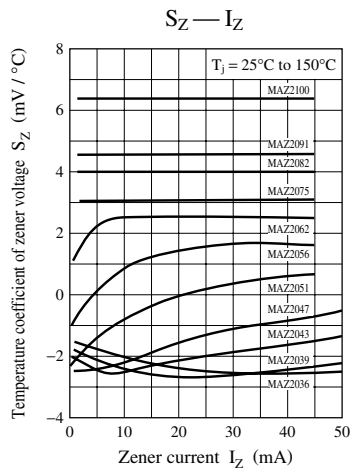

Request for your special attention and precautions in using the technical information and semiconductors described in this material

- (1) An export permit needs to be obtained from the competent authorities of the Japanese Government if any of the products or technologies described in this material and controlled under the "Foreign Exchange and Foreign Trade Law" is to be exported or taken out of Japan.
- (2) The technical information described in this material is limited to showing representative characteristics and applied circuit examples of the products. It does not constitute the warranting of industrial property, the granting of relative rights, or the granting of any license.
- (3) The products described in this material are intended to be used for standard applications or general electronic equipment (such as office equipment, communications equipment, measuring instruments and household appliances).
Consult our sales staff in advance for information on the following applications:
 - Special applications (such as for airplanes, aerospace, automobiles, traffic control equipment, combustion equipment, life support systems and safety devices) in which exceptional quality and reliability are required, or if the failure or malfunction of the products may directly jeopardize life or harm the human body.
 - Any applications other than the standard applications intended.
- (4) The products and product specifications described in this material are subject to change without notice for reasons of modification and/or improvement. At the final stage of your design, purchasing, or use of the products, therefore, ask for the most up-to-date Product Standards in advance to make sure that the latest specifications satisfy your requirements.
- (5) When designing your equipment, comply with the guaranteed values, in particular those of maximum rating, the range of operating power supply voltage and heat radiation characteristics. Otherwise, we will not be liable for any defect which may arise later in your equipment.
Even when the products are used within the guaranteed values, redundant design is recommended, so that such equipment may not violate relevant laws or regulations because of the function of our products.
- (6) When using products for which dry packing is required, observe the conditions (including shelf life and after-unpacking standby time) agreed upon when specification sheets are individually exchanged.
- (7) No part of this material may be reprinted or reproduced by any means without written permission from our company.

Please read the following notes before using the datasheets

- A. These materials are intended as a reference to assist customers with the selection of Panasonic semiconductor products best suited to their applications.
Due to modification or other reasons, any information contained in this material, such as available product types, technical data, and so on, is subject to change without notice.
Customers are advised to contact our semiconductor sales office and obtain the latest information before starting precise technical research and/or purchasing activities.
- B. Panasonic is endeavoring to continually improve the quality and reliability of these materials but there is always the possibility that further rectifications will be required in the future. Therefore, Panasonic will not assume any liability for any damages arising from any errors etc. that may appear in this material.
- C. These materials are solely intended for a customer's individual use.
Therefore, without the prior written approval of Panasonic, any other use such as reproducing, selling, or distributing this material to a third party, via the Internet or in any other way, is prohibited.