



**MELCHER**  
The Power Partners.

a bel power solutions brand

## RCM150/300 Series 150/300 W DC-DC Converters



The RCM Series converters are reliable power supplies for railway and transportation systems. There are 2 input voltage ranges covering all common railway batteries. The output delivers 150 or 300 W at 12, 15 or 24 V. The converters are designed for chassis mounting and exhibit a closed housing with cooling openings.

Many options are available, such as an output ORing FET for redundant operation, output voltage adjustment, interruption time of 10 ms (class ST2), shutdown input, and an output voltage monitor controlling a relay (change-over contact).

### Features

- RoHS lead-free-solder product
- 2 input voltage ranges, covering all railway batteries
- Single output 12, 15 or 24 V
- Closed housing for chassis mounting
- Extremely high efficiency and high power density
- Low inrush current
- 3 connectors: Input, output, auxiliary
- Overtemperature, overvoltage, overcurrent, and overload protection
- Many options available
- Compliant to EN 50155, EN 50121-3-2, AREMA
- Fire and smoke: compliant to EN 45545 and NFPA 130
- 5 year warranty



Safety-approved to the latest edition of IEC/EN 60950-1 and UL/CSA 60950-1



<sup>1</sup> pending

### Table of Contents

Description.....	1
Model Selection.....	2
Functional Description.....	3
Electrical Input Data.....	4
Electrical Output Data.....	7
Description of Options.....	10

Electromagnetic Compatibility (EMC).....	12
Immunity to Environmental Conditions.....	14
Mechanical Data.....	15
Safety and Installation Instructions.....	16
Accessories.....	18

### Model Selection

Table 1: Standard models

$V_{i\ min}^1$ [V]	Input voltage				Output		Power $P_{o\ nom}$ [W]	Efficiency <sup>2</sup>		Model	Options
	$V_{i\ cont}$ [V]	$V_{i\ max}^1$ [V]	$V_{o\ nom}$ [V]	$I_{o\ nom}$ [A]	$\eta_{min}$	$\eta_{typ}$					
14.4	16.8 (24) 45	50.4	12	12.5	150	88	90	24RCM150-12 24RCM150-15 24RCM150-24	D, M, Q, F, K		
			15	10.0	150						
			24	6.25	150	90	91				
43.2	50.4 (110) 137.5	154	12	12.5	150	91	92.5	110RCM150-12 110RCM150-15 110RCM150-24	D, M, Q, F, K		
			15	10.0	150						
			24	6.25	150	92	93				
14.4	16.8 (24) 45	50.4	12	25	300	89	90.5	24RCM300-12 24RCM300-24	D, M, Q, F, K		
			24	12.5	300	90	91				
			12	25	300	91	92.5				
43.2	50.4 (110) 137.5	154	24	12.5	300	92	93.5	110RCM300-12 110RCM300-24	D, M, Q, F, K		

<sup>1</sup> Short time; see table 2 for details.

<sup>2</sup> Efficiency at  $T_A = 25\ ^\circ\text{C}$ ,  $V_{i\ nom}$ ,  $I_{o\ nom}$ ,  $V_{o\ nom}$ , only option D fitted.

### Part Number Description

Operating input voltage  $V_{i\ cont}$  (continuously):

16.8 – 45 VDC .....24  
50.4 – 137.5 VDC ..... 110

Series .....RCM

Output power:

150 W ..... 150  
300 W .....300

Nominal output voltage:

12 V .....-12  
15 V .....-15  
24 V .....-24

Auxiliary functions and options:

Out OK, output voltage adjust, shutdown <sup>1</sup> ..... D  
Interruption time .....M  
ORing FET.....Q  
Fuse built-in.....F  
Pluggable Connectors ..... K

110 RCM 150 -24 D M Q F K

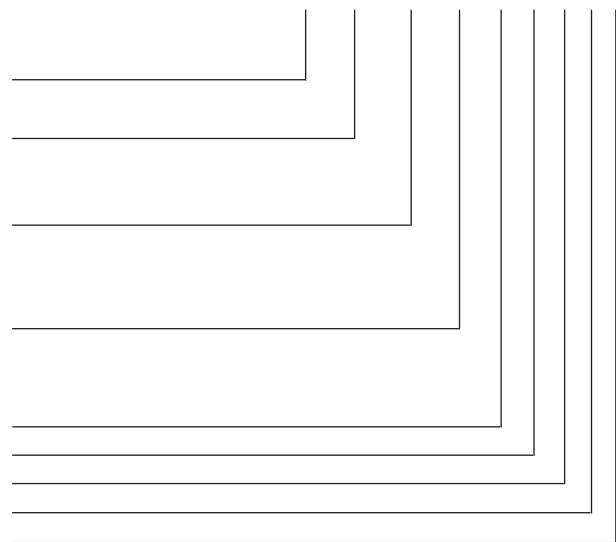

<sup>1</sup> Opt. D requires the auxiliary connector.

**Note:** The sequence of options must follow the order above.

**Note:** All models are RoHS-compliant for all six substances.

Available combinations of options:  
24/110RCMxxx-xx (K)  
24/110RCMxxx-xxD (K)  
24/110RCMxxx-xxDF (K)  
24/110RCMxxx-xxDMQ (K)  
24/110RCMxxx-xxDMQF (K)

Example: 110RCM150-24DMQ: DC-DC converter, input voltage range 50.4 to 137.5V continuously, output providing 24 V /6.25 A, monitoring relay, output voltage adjust, shutdown input, interruption time 10 ms, integrated ORing FET, operating ambient temperature  $T_A = -40$  to  $70\ ^\circ\text{C}$ , RoHS-compliant for all six substances.

### Product Marking

Type designation, applicable safety approval and recognition marks, CE mark, pin allocation, and product logo.

Input voltage range and input current, nominal output voltage and current, degree of protection, batch no., serial no., and data code including production site, version (modification status) and date of production.

### Functional Description

The converters are designed as active clamp forward converters with a switching frequency of approximately 120 kHz. The built-in high-efficient input filter together with a small input capacitance generates very low inrush current of short duration. An antiparallel diode acts as reverse polarity protection together with the external circuit breaker or fuse.

The circuitry providing the interruption time (opt. M) is located after the input filter.

The rectification on the secondary side is provided by synchronous rectifiers, in order to keep the losses as low as possible. The output voltage control logic is located on the secondary side and influences the primary logic through magnetic feedback.

An auxiliary converter supplies all circuits with a stable bias voltage.

An output ORing FET is available (option Q) and allows for a redundant power supply system. If there are no external circuit breakers, it is possible to order the converter with incorporated fuse (opt. F). Because this fuse is not accessible, a series diode provides reverse polarity protection (only with option F or M).

Opt. D encompasses an additional auxiliary connector and allows for output voltage adjust and a primary shutdown. An output voltage monitor controls a relay with a change-over contact.

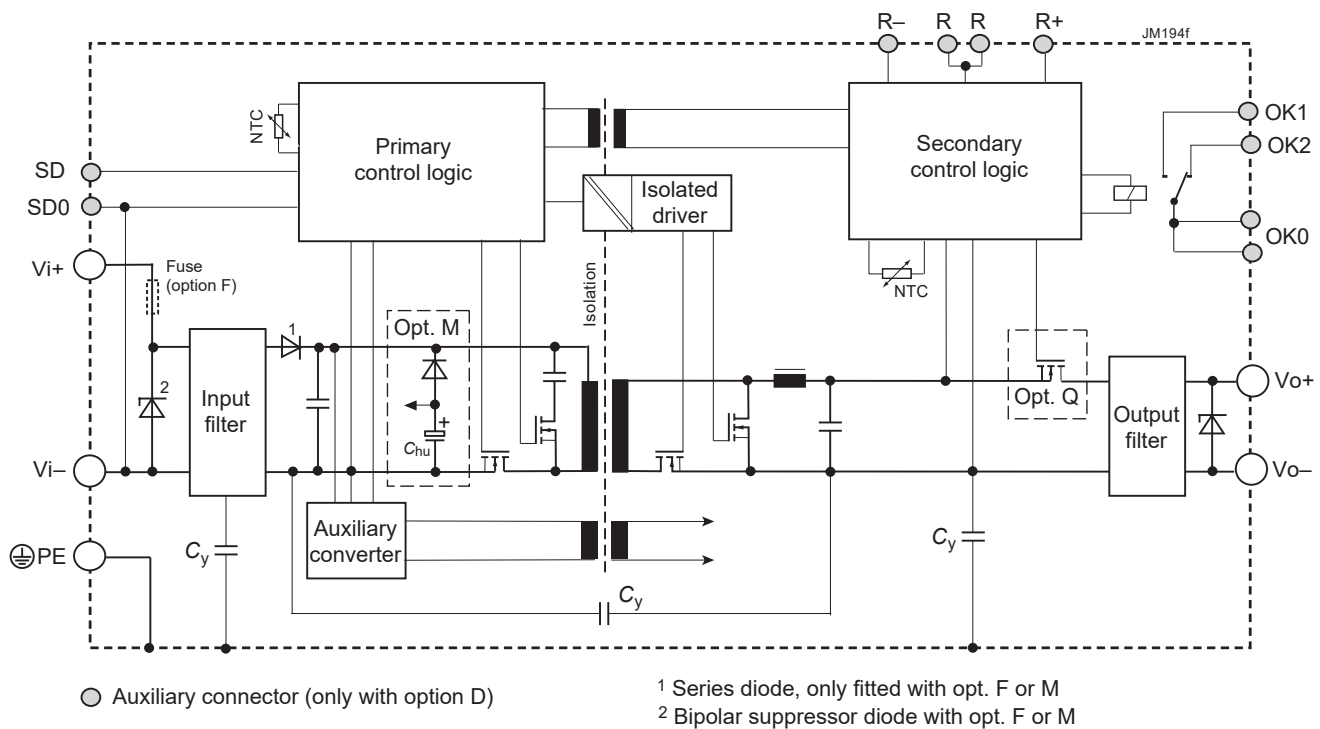

Fig. 1  
Block diagram

### Electrical Input Data

General conditions:

-  $T_A = 25\text{ °C}$ , unless  $T_C$  is specified.

Table 2a: Input data of RCM150 models

Model			24RCM150			110RCM150			Unit
Characteristics		Conditions	min	typ	max	min	typ	max	
$V_{i\text{cont}}$	Operating input voltage continuous	$I_o = 0 - I_{o\text{max}}$ $T_{C\text{min}} - T_{C\text{max}}$	16.8	(24)	45.0	50.4	(110)	137.5	V
$V_{i2s}$	for $\leq 2$ s	without shutdown	14.4		50.4	43.2		154	
$V_{i\text{nom}}$	Nominal input voltage		24, (36)			(72), (96), 110			
$V_{i\text{abs}}$	Input voltage limits	3 s without damage	0		55	0		165	
$I_i$	Typical input current	$V_{i\text{nom}}, I_{o\text{nom}}$	6.8			1.5			A
$P_{i0}$	No-load input power	$V_{i\text{min}} - V_{i\text{max}}, I_o = 0$	2.5		4	4 <sup>2</sup>		6	W
$P_{i\text{SD}}$	Idle input power	$V_{i\text{min}} - V_{i\text{max}}, V_{\text{SD}} = 0\text{ V}$	0.7		1.5	0.7 <sup>2</sup>		1.5	W
$C_i$	Input capacitance <sup>1</sup>		40			10			$\mu\text{F}$
$R_i$	Input resistance					100			m $\Omega$
$I_{\text{inr p}}$	Peak inrush current	$V_i = V_{i\text{max}}, P_{o\text{nom}}$				75			A
$t_{\text{inr d}}$	Duration of inrush current					0.5			0.5
$t_{\text{on}}$	Start-up time after removal of shutdown	$V_{i\text{min}}, P_{o\text{nom}}$				1000			ms
		$0 \rightarrow V_{i\text{min}}, P_{o\text{nom}}$				300			
		$V_{\text{SD}} = 0 \rightarrow 5\text{ V}$				300			

Table 2b: Input data of RCM300 models

Model			24RCM300			110RCM300			Unit
Characteristics		Conditions	min	typ	max	min	typ	max	
$V_{i\text{cont}}$	Operating input voltage continuous	$I_o = 0 - I_{o\text{max}}$ $T_{C\text{min}} - T_{C\text{max}}$	16.8	(24)	45.0	50.4	(110)	137.5	V
$V_{i2s}$	for $\leq 2$ s	without shutdown	14.4		50.4	43.2		154	
$V_{i\text{nom}}$	Nominal input voltage		24, (36)			(72), (96), 110			
$V_{i\text{abs}}$	Input voltage limits	3 s without damage	0		55	0		165	
$I_i$	Typical input current	$V_{i\text{nom}}, I_{o\text{nom}}$	13.9			3			A
$P_{i0}$	No-load input power	$V_{i\text{min}} - V_{i\text{max}}, I_o = 0$	4		6	4		6	W
$P_{i\text{SD}}$	Idle input power	$V_{i\text{min}} - V_{i\text{max}}, V_{\text{SD}} = 0\text{ V}$	1.5			1.5			W
$C_i$	Input capacitance <sup>1</sup>		6			12			$\mu\text{F}$
$R_i$	Input resistance					140			m $\Omega$
$I_{\text{inr p}}$	Peak inrush current	$V_i = V_{i\text{max}}, P_{o\text{nom}}$				120			A
$t_{\text{inr d}}$	Duration of inrush current					0.5			0.5
$t_{\text{on}}$	Start-up time after removal of shutdown	$V_{i\text{min}}, P_{o\text{nom}}$				1000			ms
		$0 \rightarrow V_{i\text{min}}, P_{o\text{nom}}$				300			
		$V_{\text{SD}} = 0 \rightarrow 5\text{ V}$				300			

<sup>1</sup> Not smoothed by the inrush current limiter at start-up (for inrush current calculation)

<sup>2</sup> Typ. value at  $V_{i\text{max}}$ . At lower  $V_i$ , the idle and low-load input power are smaller.

### Input Transient and Reverse Polarity Protection

A suppressor diode and a symmetrical input filter form an effective protection against input transients, which typically occur in many installations, but especially in battery-driven mobile applications.

If the input voltage has the wrong polarity, the incorporated antiparallel diode causes the external input circuit breaker or fuse to trip. With option M or F (incorporated fuse), an active reverse-polarity protection circuit prevents from any damage.

### Input Under-/Overvoltage Lockout

If the input voltage is out of range, an internally generated inhibit signal disables the converter to avoid any damage.

### Inrush Current and Stability with Long Supply Lines

The converter operates with relatively small input capacitance  $C_i$  resulting in low inrush current of short duration.

If a converter is connected to the power source through supply lines with reasonable length, no additional measures are necessary to ensure stable operation.

Only in the case of very long supply lines exhibiting a considerable inductance  $L_{ext}$ , an additional external capacitor  $C_{ext}$  connected across the input pins improves the stability and prevents oscillations; see fig. 2.

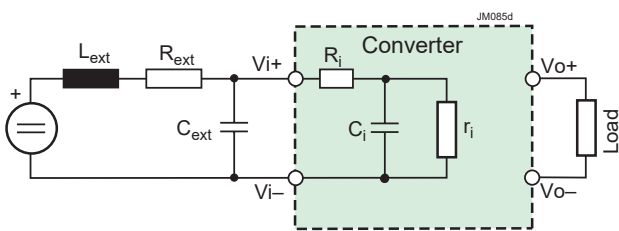

Fig. 2  
Input configuration

Table 3: Recommended values for the capacitor  $C_{ext}$

$V_{B\ nom}$	RCM150	RCM300	Rated voltage
24 V	1500 $\mu$ F	3000 $\mu$ F	40 V
36 V	1000 $\mu$ F	2000 $\mu$ F	63 V
72 V	220 $\mu$ F	440 $\mu$ F	125 V
110 V	100 $\mu$ F	200 $\mu$ F	200 V

Actually, the RCM Series converter with its load acts as negative resistor  $r_i$ , because the input current  $I_i$  rises, when the input voltage  $V_i$  is decreased. It tends to oscillate with a resonant frequency determined by the line inductance  $L_{ext}$  and the input capacitance  $C_i + C_{ext}$ , damped by the resistor  $R_{ext}$ . The whole system is not linear at all and eludes a simple calculation. One basic condition is given by the formula:

$$C_i + C_{ext} > \frac{L_{ext} \cdot P_{o\ max}}{R_{ext} \cdot V_{i\ min}^2} \quad \left( r_i = \frac{dV_i}{dI_i} \right)$$

$R_{ext}$  is the series resistor of the voltage source including supply lines. If this condition is not fulfilled, the converter may not reach stable operating conditions. Worst case conditions are at lowest  $V_i$  and highest output power  $P_o$ .

Recommended values for  $C_{ext}$  for different batteries are listed in table 3, which should allow for stable operation up to an input inductance of 2 mH.  $C_i$  is specified in table 2.

### Efficiency

The efficiency depends on the model and on the input voltage.

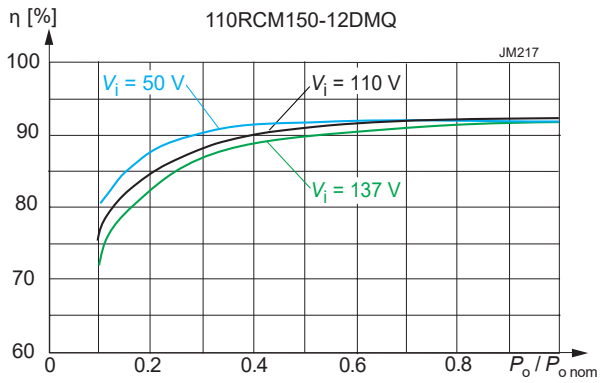

Fig. 3a  
Efficiency versus  $V_i$  and  $P_o$  (110RCM150-12DMQ)

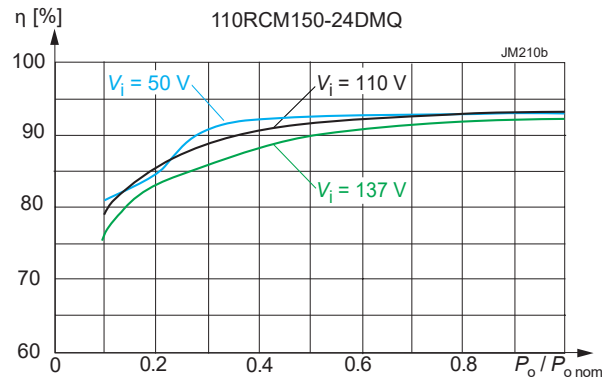

Fig. 3b  
Efficiency versus  $V_i$  and  $P_o$  (110RCM150-24DMQ)

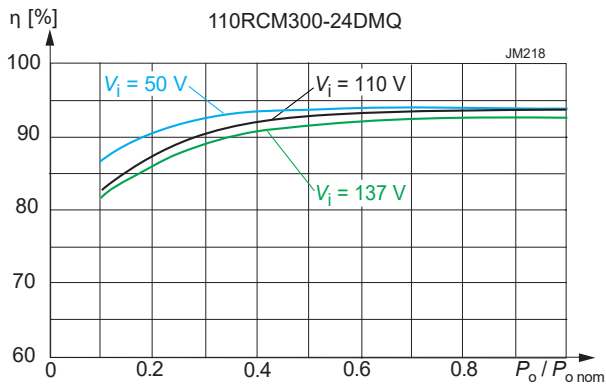

Fig. 3c  
Efficiency versus  $V_i$  and  $P_o$  (110RCM300-24DMQ)

### Electrical Output Data

General conditions:

- $T_A = 25\text{ }^\circ\text{C}$ , unless  $T_C$  is specified
- R input not connected

Table 4a: Output data of RCM150 models.

Output			12 V			15 V			24 V			Unit
Characteristics		Conditions	min	typ	max	min	typ	max	min	typ	max	
$V_o$	Output voltage <sup>1</sup>	$V_{i\text{nom}}, 0.5 I_{o\text{nom}}$	11.88	12	12.12				23.76	24	24.24	V
$V_{ow}$	Worst case output voltage	$\frac{V_{i\text{min}} - V_{i\text{max}}}{T_{C\text{min}} - T_{C\text{max}}}, 0 - I_{o\text{nom}}$	11.64		12.36				23.28		24.72	
$V_{o\text{droop}}$	Output voltage droop			- 20					- 40			mV/A
$V_{oL}$	Overvoltage shutdown <sup>6</sup>			14					28			V
$V_{oP}$	Overvoltage protection <sup>2</sup>		14.3	15	15.8				28.5	30	31.5	
$I_{o\text{nom}}$	Nominal output current			12.5					6.25			A
$I_{oL}$	Output current limit	$T_{C\text{min}} - T_{C\text{max}}$	13.0		15				6.5		7.2	
$V_o$	Output noise <sup>3</sup>	Switching frequency	$V_{i\text{nom}}, I_{o\text{nom}}$			40			80			mV <sub>pp</sub>
		Total incl. spikes	BW = 20 MHz			60			120			
$V_{od}$	Dynamic load regulation	Voltage deviation <sup>5</sup>	$V_{i\text{nom}}$			700			1000			ms
$t_d$ <sup>4</sup>		Recovery time	$0.1 \leftrightarrow 0.9 I_{o\text{nom}}$			5			5			
$\alpha_{vo}$	Temperature coefficient of $v_o$ (NTC)	$0 - I_{o\text{nom}}, T_{C\text{min}} - T_{C\text{max}}$	- 0.02		0				- 0.02		0	%/K

Table 4b: Output data of RCM300 models.

Output			12 V			24 V			Unit			
Characteristics		Conditions	min	typ	max	min	typ	max				
$V_o$	Output voltage <sup>1</sup>	$V_{i\text{nom}}, 0.5 I_{o\text{nom}}$	11.88	12	12.12	23.76	24	24.24	V			
$V_{ow}$	Worst case output voltage	$\frac{V_{i\text{min}} - V_{i\text{max}}}{T_{C\text{min}} - T_{C\text{max}}}, 0 - I_{o\text{nom}}$	11.64		12.36	23.28		24.72				
$V_{o\text{droop}}$	Output voltage droop			- 20			- 40		mV/A			
$V_{oL}$	Overvoltage shutdown <sup>6</sup>			14			28		V			
$V_{oP}$	Overvoltage protection <sup>2</sup>		14.3	15	15.8	28.5	30	31.5				
$I_{o\text{nom}}$	Nominal output current			25			12.5		A			
$I_{oL}$	Output current limit	$T_{C\text{min}} - T_{C\text{max}}$	27		30	13.5		15				
$V_o$	Output noise <sup>3</sup>	Switching frequency	$V_{i\text{nom}}, I_{o\text{nom}}$			60			80			mV <sub>pp</sub>
		Total incl. spikes	BW = 20MHz			80			120			
$V_{od}$	Dynamic load regulation	Voltage deviation <sup>5</sup>	$V_{i\text{nom}}$			1000			1200			ms
$t_d$ <sup>4</sup>		Recovery time	$0.1 \leftrightarrow 0.9 I_{o\text{nom}}$			5			5			
$\alpha_{vo}$	Temperature coefficient of $v_o$ (NTC)	$0 - I_{o\text{nom}}, T_{C\text{min}} - T_{C\text{max}}$	- 0.02		0		- 0.02		0	%/K		

<sup>1</sup> If the output voltage is increased above  $V_{o\text{nom}}$  through R-input control, the output power should be reduced accordingly, so that  $P_{o\text{max}}$  and  $T_{C\text{max}}$  are not exceeded.

<sup>2</sup> Breakdown voltage of the incorporated suppressor diode at 1 mA. Exceeding this value might damage the suppressor diode.

<sup>3</sup> Measured according to IEC/EN 61204 with a probe described in annex A

<sup>4</sup> Recovery time until  $V_o$  returns to  $\pm 1\%$  of  $V_o$ ; see fig. 4.

<sup>5</sup> No overshoot at switch on.

<sup>6</sup> Output overvoltage protection by an electronic circuitry.

**Output Voltage Regulation**

Line and load regulation of the output is so good that input voltage and output current have virtually no influence to the output voltage.

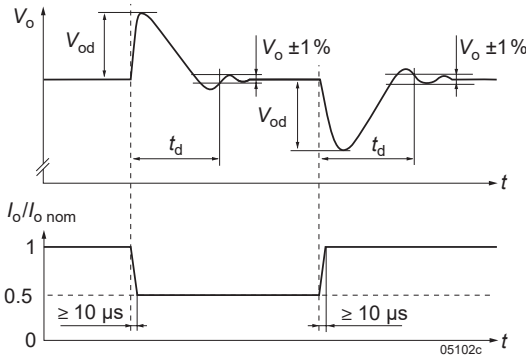

Fig. 4  
Typical dynamic load regulation of output voltage

**Thermal Considerations and Protection**

A temperature protection is incorporated in the primary and secondary control logic each. It generates an internal inhibit signal, which disables the converter in case of overtemperature. The converter automatically recovers, when the temperature drops below the limit. See fig. 5. The relationship between  $T_A$  and  $T_C$  depends heavily upon the conditions of operation and integration into a system.

**Caution:** The installer must ensure that under all operating conditions  $T_C$  remains within the limits stated in table 8.

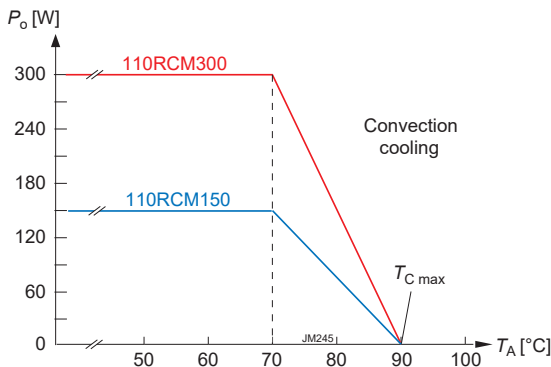

Fig. 5  
Typical output power derating versus temperature; vertical mounting position, free convection cooling.

**Output Current Limitation**

The output is continuously protected against open-circuit (no load) and short-circuit by an electronic current limitation with rectangular characteristic; see fig. 5.

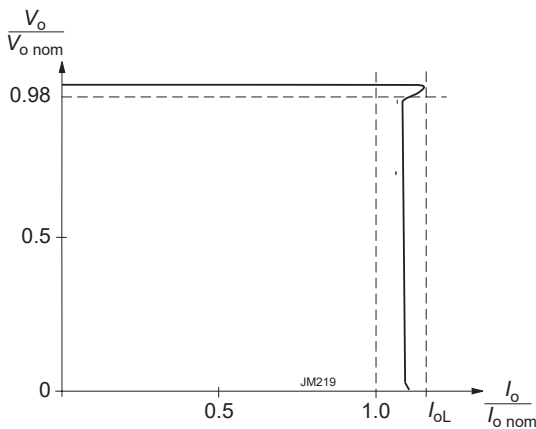

Fig. 6  
Rectangular current limitation



### Series and Parallel Connection

The outputs of several RCM Series converters may be connected in series.

**Note:** If the sum of the output voltages is greater than 60 V, it cannot be considered as SELV (Safety Extra Low Voltage) according to the safety standards.

Several RCM models of the same type can be operated in parallel connection. To ensure proper current sharing, the load lines should have equal length and section. The output voltage exhibits a slight droop characteristic, which facilitates current sharing. In addition, the output voltage tends to be lowered with increasing temperature.

### Redundant Systems

For redundant systems, we recommend the options Q and D, see *Options*.

### LED Indicator

The converters exhibit a green LED “Out OK”, signaling that the output voltage is within the specified range.

## Description of Options

### Option D: Output Monitor, Output Adjust, Shutdown

Option D consists of several auxiliary functions and encompasses an additional auxiliary connector.

#### Output Voltage Adjust (R)

**Note:** With open R-input,  $V_o = V_{o\text{nom}}$ .

The converter allows for adjusting the output voltage in the range of 80 to 105% of  $V_{o\text{nom}}$ . The adjust is accomplished by an external resistor  $R_{\text{ext1}}$  or  $R_{\text{ext2}}$ , connected to the R-input; see fig. 7.

Depending on the value of the required output voltage, the resistor shall be connected:

**either:** Between the R-pin and R- to adjust the output voltage to a value below  $V_{o\text{nom}}$ :

$$R_{\text{ext1}} \approx 4 \text{ k}\Omega \cdot \frac{V_o}{V_{o\text{nom}} - V_o} - 15.8 \text{ k}\Omega$$

**Note:**  $R_{\text{ext1}} = 0 \Omega$  reduces  $V_o$  to 80%.

**or:** Between the R-pin and R+ to adjust the output voltage to a value greater than  $V_{o\text{nom}}$ :

$$R_{\text{ext2}} \approx 4 \text{ k}\Omega \cdot \frac{(V_o - 2.5 \text{ V})}{2.5 \text{ V} \cdot (V_o/V_{o\text{nom}} - 1)} - R_a$$

**Note:**  $R_{\text{ext2}} = 0 \Omega$  increases  $V_o$  to 105%.

$R_a = 300 \text{ k}\Omega$  for  $V_{o\text{nom}} = 12 \text{ V}$      $R_a = \text{xxx k}\Omega$  for  $V_{o\text{nom}} = 15 \text{ V}$      $R_a = 680 \text{ k}\Omega$  for  $V_{o\text{nom}} = 24 \text{ V}$

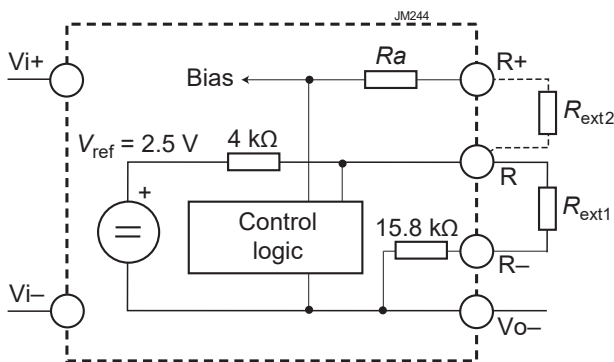

Fig. 7  
Output voltage control via R-input

#### Output Voltage Monitor (D)

The output voltage  $V_o$  is monitored. When  $V_o$  is in range, a relay with a change-over contact is activated, connecting OK0 with OK1.

**Note:** The trigger levels are typ.  $\pm 5\%$  of  $V_{o\text{nom}}$  (with open R-input).

Data of relay contacts: 0.4 A / 150 VDC

#### Primary Shutdown (SD)

The output of the converter may be enabled or disabled by a logic signal (e.g. CMOS) applied between the shutdown pin SD and SD0 (= Vi-). If the shutdown function is not required, pin SD can be left open-circuit. Voltage on pin SD:

Converter operating: 12 to 154 V or open-circuit  
Converter disabled: -2 to +2 V

The output response is shown in fig. 8.

**Note:** In systems consisting of several converters, this feature may be used to control the activation sequence by logic signals or to enable the power source to start up, before full load is applied.

**Option M: Interruption Time**

The interruption time  $t_{hu}$  is specified in the railway standard EN 50155:2017 clause 5.1.1.4: It is tested at the nominal battery voltage for interruption and short-circuit of the input. After such an event, the system is ready for another such event after 10 s. Fig. 8 shows the output voltage  $V_o$  with option M.

$t_{hu} = 10$  ms (Class S2) in all other cases.

For less critical applications, option M is not required (class S1, no interruption time).

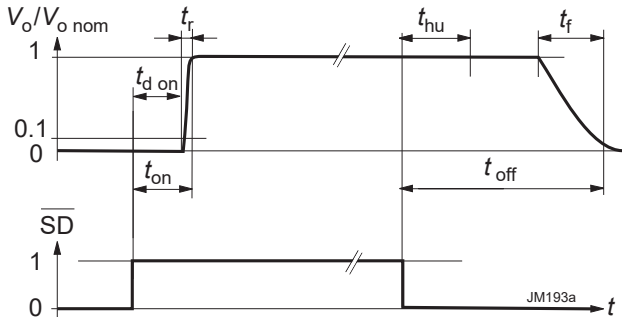

Fig. 8  
Typical output response to the SD-signal. If option M is not fitted,  $t_{hu} = 0$  ms.

**Option Q: ORing FET for Redundant Systems**

The outputs of 2 parallel connected converters are separated with ORing diodes (built by FETs). If one converter fails, the remaining one must be capable to still deliver the full power to the load. If more power is needed, the system may be extended to more parallel converters (n+1 redundancy).

Current sharing must be ensured by load lines of equal section and length. In addition, a slight droop characteristic of the output voltage and a negative temperature coefficient are helpful as well.

To keep the losses as small as possible, the ORing diode is replaced by a FET. The voltage drop is approx. 22 mV (not dependent of  $I_o$ ).

**Note:** In the case of a failing converter, the output voltage is maintained by the redundant converters. However, the failing item should be identified and replaced. We recommend the Out OK function (option D).

**Option F: Incorporated Fuse**

The railway standard EN 50155 disadvises fuses in the converters. Consequently, the installer must preview an external fuse or circuit breaker. However, when this is not possible, an incorporated fuse is available (option F). This fuse is not accessible and will not trip, except if the converter is defect.

**Note:** Converters with option F or option M are protected against input reverse polarity by a series diode.

Table 5: Recommended external fuses (same as with option F)

Converter	Specification	Ordering number
24RCM150	15 A fast acting	BEL 0ADE (P) 15-R
24RCM300	25 A fast acting	BEL 0ADE (P) 25-R
110RCM150	5 A fast acting	Littelfuse 0507 005.MXEP
110RCM300	8 A fast acting	Littelfuse 0507 008.MXEP

**Option K: Pluggable Connectors**

This option allows the use of pre-assembled pluggable connectors; for details see *Accessories*.

**Note:** Female connectors must be ordered separately.

## Electromagnetic Compatibility (EMC)

### Electromagnetic Immunity

Table 6: Electromagnetic immunity (type tests). Corresponds or Exceeds EN50121-3-2:2016 and AREMA

Phenomenon	Standard	Level	Coupling mode <sup>1</sup>	Value applied	Waveform	Source imped.	Test procedure	In oper.	Perf. crit. <sup>2</sup>					
Electrostatic discharge (to case)	IEC/EN 61000-4-2	4	contact discharge	6000 V <sub>p</sub>	1/50 ns	330 Ω 150 pF	10 pos. & 10 neg. discharges	yes	A					
			air discharge	8000 V <sub>p</sub>										
Electromagnetic field	IEC/EN 61000-4-3	x	antenna	20 V/m	AM 80% / 1 kHz	N/A	80 – 800 MHz	yes	A					
			antenna	20 V/m						AM 80% / 1 kHz	N/A	800 – 1000 MHz	yes	A
				20 V/m										
				5 V/m										
3 V/m	5100 – 6000 MHz													
Electrical fast transients/burst	IEC/EN 61000-4-4	3	capacitive, o/c	±2000 V <sub>p</sub>	bursts of 5/50 ns; 2.5/5 kHz over 15 ms; burst period: 300 ms	50 Ω	60 s positive 60 s negative transients per coupling mode	yes	A					
		3	i/c, +i/-i direct coupling											
Surges	IEC/EN 61000-4-5	3	i/c	±2000 V <sub>p</sub>	1.2 / 50 μs	42 Ω 0.5 μF	5 pos. & 5 neg. surges per coupling mode	yes	A					
			+i/-i	±1000 V <sub>p</sub>					B					
			i/c, +i/-i	±2000 V <sub>p</sub>										
Conducted disturbances	IEC/EN 61000-4-6	3	i, o, signal wires	10 VAC (140 dBμV)	AM 80% / 1 kHz	150 Ω	0.15 – 80 MHz	yes	A					

<sup>1</sup> i = input, o = output, c = case

<sup>2</sup> A = normal operation, no deviation from specs.; B = normal operation, temporary loss of function or deviation from specs possible

### Electromagnetic Emissions

All conducted emissions (fig. 9) have been tested as per EN 55011, group 1, class A. These limits are much stronger than requested in EN 50121-3-2:2016, table 2.1, and coincide with EN 50121-4:2016, table 1.1. The values in fig. 9 are quasipeak values, which are always lower than peak values.

The average values must respect a margin of 10 dBµV below the limits for quasipeak.

Radiated emissions have been tested according to EN 55011, group 1, class A. These limits are similar to the requirements of EN 50121-3-2:2016 and EN 50121-4:2016, both calling up EN 61000-6-4+A1:2011, table 1. The tests were executed with horizontal and vertical polarization. The worse result is shown in fig. 10.

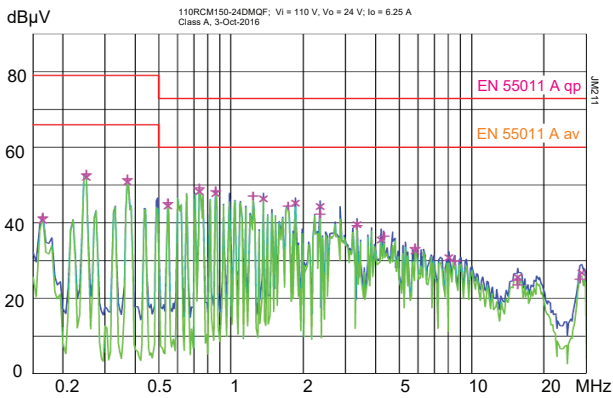

Fig. 9a  
110RCM150-24: Typ. disturbance voltage at the input ( $V_i = 110\text{ V}$ ,  $I_{i\text{nom}}$ , resistive load, quasi peak and average)

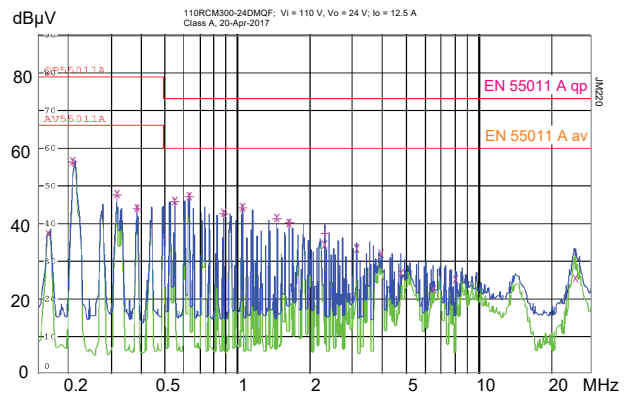

Fig. 9b  
110RCM300-24: Typ. disturbance voltage at the input ( $V_i = 110\text{ V}$ ,  $I_{i\text{nom}}$ , resistive load, quasi peak and average)

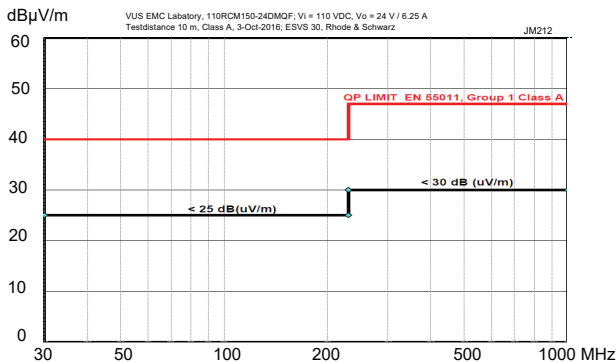

Fig. 10a  
110RCM150-24: Typ. radiated disturbances in 10 m distance ( $V_i = 110\text{ V}$ ,  $I_{i\text{nom}}$ , resistive load, quasi peak).

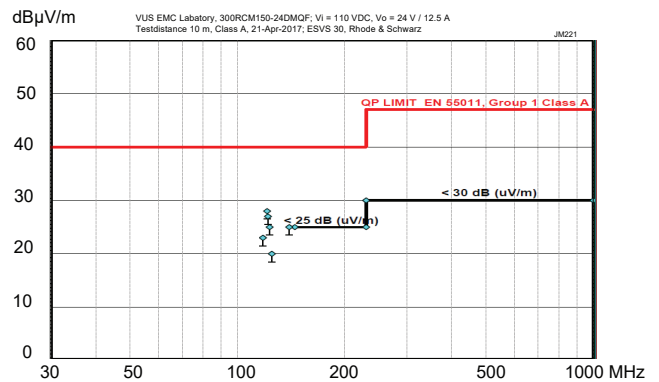

Fig. 10b  
110RCM300-24: Typ. radiated disturbances in 10 m distance ( $V_i = 110\text{ V}$ ,  $I_{i\text{nom}}$ , resistive load, quasi peak).

## Immunity to Environmental Conditions

Table 7: Mechanical and climatic stress. Air pressure 800 – 1200 hPa

Test method		Standard	Test Conditions	Status
Ad	Low temperature start-up test	EN 50155:2017, clause 13.4.4 IEC/EN 60068-2-1	Temperature, duration: - 40 °C, 2 h Performance test: +25 °C	Not operating
Be	Dry heat test, cycle A	EN 50155:2017, clause 13.4.5 IEC/EN 60068-2-2	Temperature: 70 °C Duration: 6 h	Operating perf. crit. A
Db 2	Cyclic damp heat test	EN 50155:2017, clause 13.4.7 IEC/EN 60068-2-30	Temperature: 55 °C and 25 °C Cycles (respiration effect): 2 Duration: 2x 24 h	Not operating
Ka	Salt mist test sodium chloride (NaCl) solution	EN 50155:2017, clause 13.4.10 IEC/EN 60068-2-11	Temperature: 35 ±2 °C Duration: 48 h	Converter not operating
-	Functional random vibration test	EN 50155:2017 clause 13.4.11.4 EN 61373:2010 clause 8, class B, body mounted <sup>1</sup>	Acceleration amplitude: 0.1 g <sub>n</sub> = 1.01 m/s <sup>2</sup> Frequency band: 5 – 150 Hz Test duration: 30 min (10 min in each axis)	Operating perf. crit. A
-	Simulated long life testing	EN 50155:2017 clause 13.4.11.2 EN 61373:2010 clause 9, class B, body mounted <sup>1</sup>	Acceleration amplitude: 0.58 g <sub>n</sub> = 5.72 m/s <sup>2</sup> Frequency band: 5 – 150 Hz Test duration: 15 h (5 h in each axis)	Not operating
-	Shock test	EN 50155:2017 clause 13.4.11.3 EN 61373:2010 clause 10, class B, body mounted <sup>1</sup>	Acceleration amplitude: 5.1 g <sub>n</sub> Bump duration: 30 ms Number of bumps: 18 (3 in each direction)	Operating perf. crit. A
-	Vibration sinusoidal	AREMA Part. 11.5.1 class C, D, E, I, J	Acceleration amplitude: 0.3" (5 – 20 Hz) 1.5 g <sub>n</sub> = 14.7 m/s <sup>2</sup> Frequency: 10 – 200 Hz Test duration: 12 h (4 h in each axis)	Operating perf. crit. A
-	Mechanical shock	AREMA Part. 11.5.1 class C, D, E, I, J	Acceleration amplitude: 10 g <sub>n</sub> = 98 m/s <sup>2</sup> Bump duration: 11 ms Number of bumps: 18 (3 in each direction)	Operating perf. crit. A

<sup>1</sup> Body mounted = chassis of a railway coach

## Temperatures

Table 8: Temperature specifications, valid for an air pressure of 800 – 1200 hPa (800 – 1200 mbar)

Temperature		Conditions	EN 50155:2017 Class OT4			Unit
Characteristics			min	max	10 minutes	
T <sub>A</sub>	Ambient temperature	Converter operating	- 40	70	85	°C
T <sub>C</sub>	Case temperature <sup>1</sup>		- 40	90		
T <sub>S</sub>	Storage temperature	Not operational	- 55	85		

<sup>1</sup> Measured at the measurement point T<sub>C</sub>; see Mechanical Data.

## Reliability

Table 9: MTBF and device hours

Ratings at specified case temperature between failures	Model	MTBF
Accord. to IEC 62380	110RCM150-24DMQF	1 137 600 h
	110RCM300-24DMQF	1 126 000 h

**Mechanical Data**

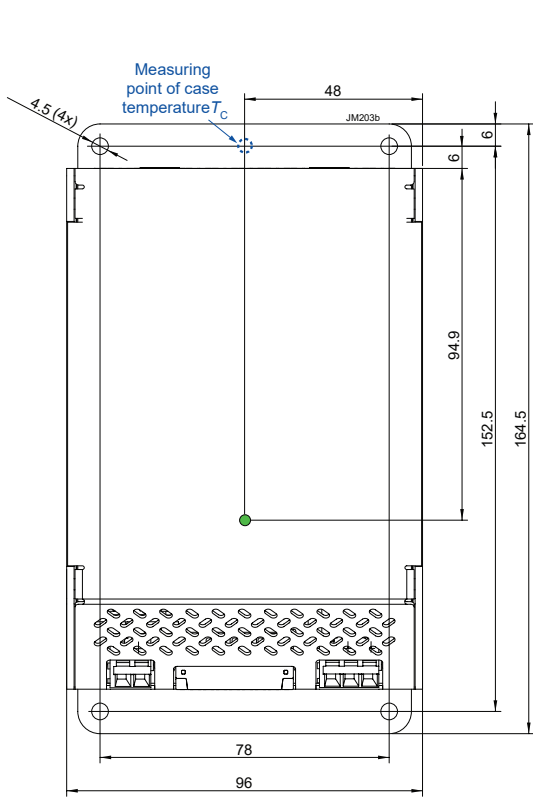

Standard models  
RCM150

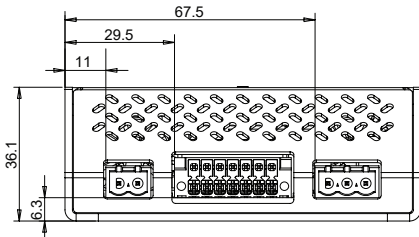
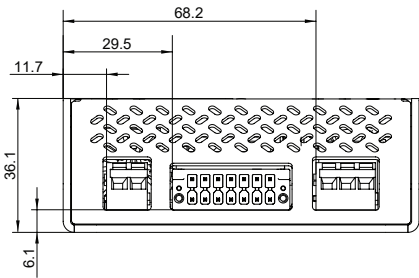

RCM150  
with  
option K

**Fig. 11a**  
Case of RCM150 (RCM01)  
weight approx. 520 g, Aluminum, EP-powder coated

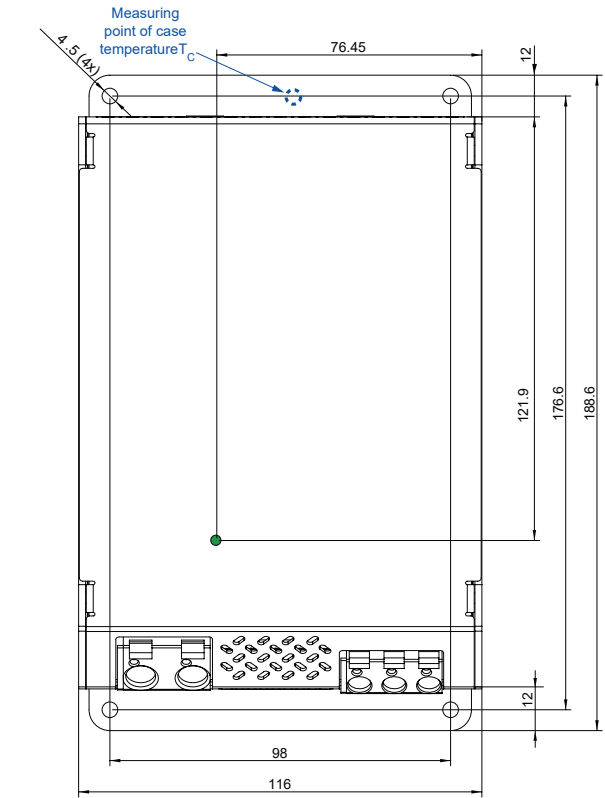

Standard models  
RCM300

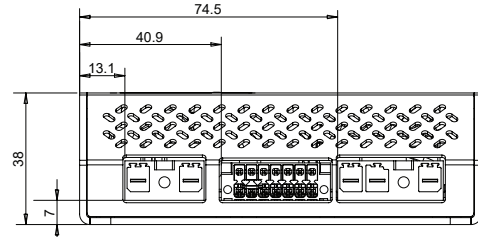
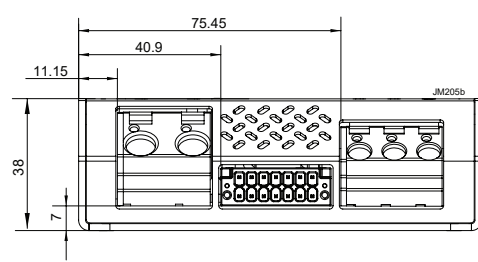

RCM300  
with  
option K

**Fig. 12a**  
Case of RCM300 (RCM02)  
weight approx. 820 g, Aluminum, EP-powder coated

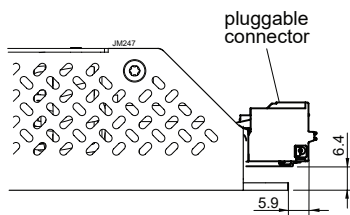

**Fig. 11b**  
Plugged connector for RCM150 with option K

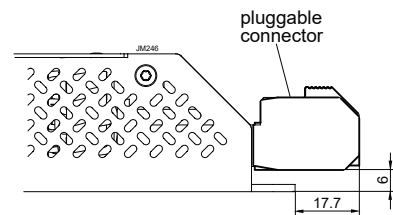

**Fig. 12b**  
Plugged connector for RCM300 with option K

## Safety and Installation Instruction

### Connectors and Pin Allocation of RCM150

- Input connector, 3 pins: Wago 236-403: Vi+, Vi-, PE; wire section: 0.08 – 2.5 mm<sup>2</sup>, 28 – 12 AWG; with option K: Phoenix Contact 1923762
- Output connector, 2 pins: Wago 236-402: Vo+, Vo-; wire section: 0.08 – 2.5 mm<sup>2</sup>, 28 – 12 AWG with option K: Phoenix Contact 1923759
- Auxiliary connector: Phoenix Contact 1713883; pin allocation see fig. 13.

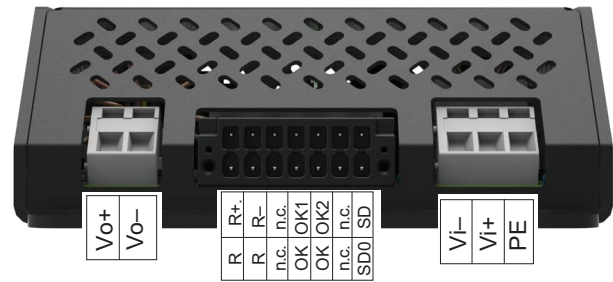

Fig. 13  
Pin allocation of RCM150

### Connectors and Pin Allocation of RCM300

- Input connector, 3 pins: Wago 745-353: Vi-, Vi+, PE wire section: 0.2 – 6 mm<sup>2</sup>, 24 – 10 AWG with option K: Weidmüller 1048500000
- Output connector, 2 pins: Wago 745-602/006, Vo-, Vo+ wire section: 0.2 – 16 mm<sup>2</sup>, 24 – 10 AWG with option K: Weidmüller 1048390000
- Auxiliary connector: Phoenix Contact 1713883; pin allocation see fig. 14.

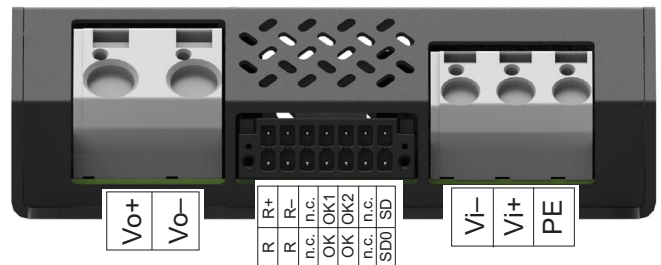

Fig. 14  
Pin allocation of RCM300

### Installation Instruction

These converters are components, intended exclusively for inclusion by an industrial assembly process or by a professionally competent person. Installation must strictly follow the national safety regulations in respect of the enclosure, mounting, creepage distances, clearances, markings and segregation requirements of the end-use application.

Connection to the system shall only be effected with cables with suitable wire section.

The auxiliary connector shall be connected via the suitable female connector; see *Accessories*.

Other installation methods may not meet the safety requirements. Check that PE is safely connected to protective earth.

No fuse is incorporated in the converter (except for option F). An external circuit breaker or a fuse in the wiring to one or both input pins.

Do not open the converters, or the warranty will be invalidated. Make sure that there is sufficient airflow available for convection cooling and that the temperature of the bottom plate is within the specified range. This should be verified by measuring the case temperature at the specified measuring point, when the converter is operated in the end-use application.  $T_{C_{max}}$  should not be exceeded. Ensure that a failure of the converter does not result in a hazardous condition.

### Standards and Approvals

The RCM Series converters are approved according to the last edition of IEC/EN 60950-1 and UL/CSA 60950-1.

They have been evaluated for:

- Class I equipment
- Building in
- Double or reinforced insulation based on 250 VAC or 240 VDC between input and output, and between input and the relay contacts (OK0, OK1, OK2)
- Pollution degree 2 environment.

The converters are subject to manufacturing surveillance in accordance with the above mentioned UL standards and with ISO 9001.



### Cleaning Liquids and Protection Degree

The converters are not hermetically sealed. In order to avoid possible damage, any penetration of liquids shall be avoided.  
The converters correspond to protection degree IP 30.

### Railway Applications

The RCM Series converters have been designed observing the railway standards EN 50155:2017, EN 50121-3-2:2016, and AREMA. All boards are coated with a protective lacquer.

The converters comply with the fire & smoke standard EN 45545:2016, HL1 to HL3.

### Insulation Test

The electric strength test is performed in the factory as routine test in accordance with EN 50514, EN 50155:2017, and AREMA. It should not be repeated in the field, and the Company will not honor warranty claims resulting from incorrectly executed electric strength tests.

Table 10: Isolation

Characteristics		Input to		Output to Case	OK contacts to			Unit
		Output <sup>1</sup>	Case + Output		Input	Case	Outputs	
Electric strength test	Factory test 10 s	4.2	2.86	2.86	2.86	2.86	2.86	kVDC
	AC test voltage equivalent to factory test	3.0	2.0	2.0	2.0	2.0	2.0	kVAC
Insulation resistance		>300 <sup>2</sup>	>300 <sup>2</sup>	>300	>300	>300	>300	MΩ
Creepage distances		5.0	3.5	3.5	3.5	3.5	3.5	mm

<sup>1</sup> Pretest of subassemblies in accordance with IEC/EN 60950

<sup>2</sup> Tested at 500 VDC

## Accessories

### Female Connectors

A suitable female auxiliary connector HZZ00145-G (Phoenix Contact 1790344) is available; see fig. 15.

Wire section: 0.2 – 1.5 mm<sup>2</sup>, 24 – 16 AWG.

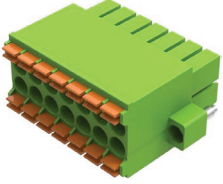

Fig. 15  
Female connector 14 pins, HZZ00145-G  
(Phoenix Contact 1790344)

For converters RCM150 with option K, use (see fig. 16):

- HZZ00300-G (3 poles, Phoenix Contact 1942167)
- HZZ00301-G (2 poles, Phoenix Contact 1942154).

Wire section: 0.2 – 2.5 mm<sup>2</sup>, 24 – 12 AWG.



Fig. 16  
Female connectors for RCM150 with option K

For converters RCM300 with option K, use (see fig. 17):

- HZZ00303-G (3 poles, Weidmüller 1060580000)
- HZZ00302-G (2 poles, Weidmüller 1060550000).

Wire section: 0.5 – 10 mm<sup>2</sup>, 24 – 8 AWG

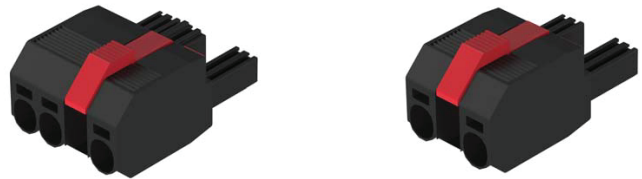

Fig. 17  
Female connectors for RCM300 with option K

**NUCLEAR AND MEDICAL APPLICATIONS** - These products are not designed or intended for use as critical components in life support systems, equipment used in hazardous environments, or nuclear control systems.

**TECHNICAL REVISIONS** - The appearance of products, including safety agency certifications pictured on labels, may change depending on the date manufactured. Specifications are subject to change without notice.