

## Product Specification

### 10Gbps 850nm VCSEL, LC and SC TOSA Package

#### HFE6x92-761

#### PRODUCT FEATURES

- High performance VCSEL
- Low electrical parasitic TO package with flexible interface
- Data rates from DC to 12.5Gbps
- Complete isolation between the VCSEL, Monitor Photodiode and Case
- Mechanically compatible with all 10Gbps MSAs

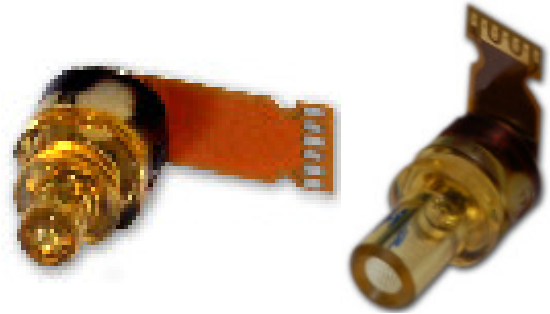

The HFE6x92-761 uses a high-performance Vertical Cavity Surface Emitting Laser (VCSEL) designed to meet performance requirements for 10Gbps data communication over multimode optical fiber. Applications include Ethernet, Fibre Channel and ATM protocols. The optical assembly is designed to inter-face either 50 $\mu$ m or 62.5 $\mu$ m multimode fiber and ensure launch conditioning requirements compatibility with enhanced bandwidth fiber as specified by TIA 455-203.

The HFE6x92-761 incorporates a power monitoring photodiode that can be used for temperature compensation, average power control, and for compliance with Class 1 eye safety limits.

#### PRODUCT SELECTION

Part Number	Description
HFE6192-761	Differentially Driven, attenuated, LC TOSA, with 50 $\Omega$ flex
HFE6392-761	Differentially Driven, attenuated, SC TOSA, with 50 $\Omega$ flex

## I. Absolute Maximum Ratings

Parameter	Rating
Storage Temperature	-40 to +85°C
Case Operating Temperature	0* to +85°C
Lead Solder Temperature	260°C, 10 sec.
Reverse Power Supply Voltage	5V
Max continuous forward current	12mA
ESD Exposure (Human Body Model)	150V <sup>1</sup>

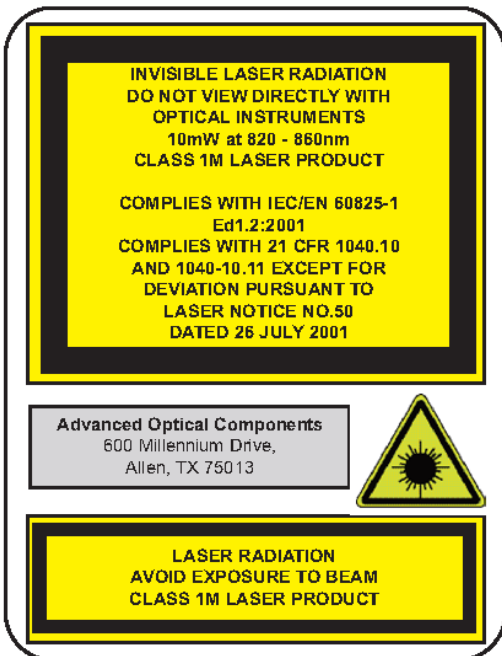

### Notice

Stresses greater than those listed under “Absolute Maximum Ratings” may cause permanent damage to the device. This is a stress rating only and functional operation of the device at these or any other conditions above those indicated in the operations section for extended periods of time may affect reliability.

### Notice

The inherent design of this component causes it to be sensitive to electrostatic discharge (ESD). To prevent ESD-induced damage and/or degradation to equipment, take normal ESD precautions when handling this product

## II. Electro-Optical Characteristics ( $T_A=25C$ , unless otherwise stated)

VCSEL Parameters	Test Condition	Symbol	Min.	Typ.	Max.	Units	Notes
Fiber coupled optical power	$I_F = 6.5mA$ peak	$P_{OC}$	400	600		$\mu W$	
Coupling Efficiency	50/125 $\mu m$ fiber	PO_PCT	70			%	1
Threshold Current	$I_F = 6.5mA$	$I_{TH}$		1	2	mA	
Threshold Current Temperature Variation		$\Delta I_{TH}$			1	mA	2
Slope Efficiency	$T_A=0$ to $70^\circ C$	$\eta$	0.06	0.075	0.2	mW/mA	3
Slope Efficiency Temperature Variation	$P_{OC}=0.6mW$	$\Delta\eta/\Delta T$		-0.4		%/ $^\circ C$	
Peak Wavelength	$T_A=0$ to $70^\circ C$	$\lambda_p$	840		860	nm	
$\lambda_p$ Temperature Variation	$I_F=6.5mA$	$\Delta\lambda_p/\Delta T$		0.06		nm/ $^\circ C$	
RMS Spectral Bandwidth	$T_A=0$ to $70^\circ C$	$\Delta\lambda$			0.4	nm	
Laser Forward Voltage	$I_F=6.5mA$	$V_F$	1.6	1.8	2.2	V	
Laser Reverse Voltage	$I_F=6.5mA$	$V_R$	5	10		V	
Rise/Fall Time	$I_R=10\mu A$	$T_R$ $T_F$			40 40	ps	4
Relative Intensity Noise	Bias above threshold 20%-80%	$RIN_{12}$			-130	dB/Hz	5
Series Resistance	$I_F=6.5mA$	R	41	60	75	Ohms	
Series Resistance Temperature Variation	$I_F=6.5mA$	$\Delta R/\Delta T$		-0.2		%/ $^\circ C$	
Total Capacitance	$I_F=6.5mA$	$C_T$			0.5	pF	6
Encircled Flux Diameter	$I_F=6.5mA$	EF					7
Photodiode Parameters	Test Condition	Symbol	Min.	Typ.	Max.	Units	Notes
Monitor Current	$P_{OC}=0.6mW$ , $V_R=3V$	$I_{PD}$	50	150	300	$\mu A$	
Monitor Current Temperature Variation	$P_{OC}=0.6mW$ $T_A=0$ to $70^\circ C$	$\Delta I_{PD}/\Delta T$		0.0		%/ $^\circ C$	
Tracking Ratio Variation (Open Bore)	$P_{OB}=-2.5dBm$ $T_A=0$ to $70^\circ C$	$\Delta TR$	-0.5		+0.5	dB	
Dark Current	$P_{OC}=0mW$ , $V_R=3V$	$I_{DARK}$			20	nA	
PD Reverse Voltage	$P_{OC}=0mW$ , $I_R=10\mu A$	$BVR_{PD}$	30	115		V	8
PD Capacitance	$V_R=0V$ , Freq=1MHz $V_R=3V$ , Freq=1MHz	$C_{PD}$		75 40	100 55	pF	

### Notes:

1. PO\_PCT is defined as the ratio of the coupled power into a 50/125 micron fiber to the total power output from the optical front end as measured on a large area detector.
2. Operation outside of the specified range may result in the threshold current exceeding the maximums defined in the electro-optical characteristics table. DITH is the maximum deviation from the  $25^\circ C$  value.
3. Slope efficiency is defined as  $\Delta PO/\Delta IF$  at a total power output of 0.6mW. Slope efficiency is intentionally lowered to the value shown by attenuation.
4. Rise and fall times are sensitive to drive electronics. Rise and fall times are measured 20%-80% using a 1GHz square wave AC coupled to the VCSEL using a bias-T. The DC current is adjusted to achieve a minimum OMA of -4dBm. Corrections are made for finite detector bandwidth.
5.  $RIN_{12}$  is measured using the OMA technique with 12dB return.
6. Total capacitance is measured with the VCSEL forward biased using a Network analyzer at 1GHz.
7. Encircled flux is measured per TIA-455-203.
8. To prevent VCSEL damage, short the VCSEL anode and cathode during BVR testing

### III. Typical Performance Curves

**RMS Spectral Width** is defined and measured using TIA-455-127

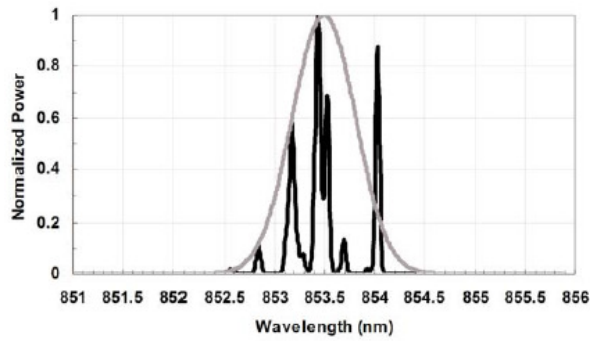

**Threshold Current vs. Temperature:** Threshold current varies parabolically with temperature; thus it can be nearly constant for a limited temperature range.

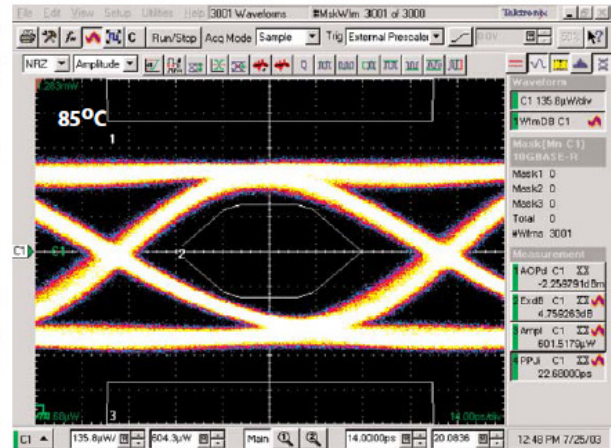
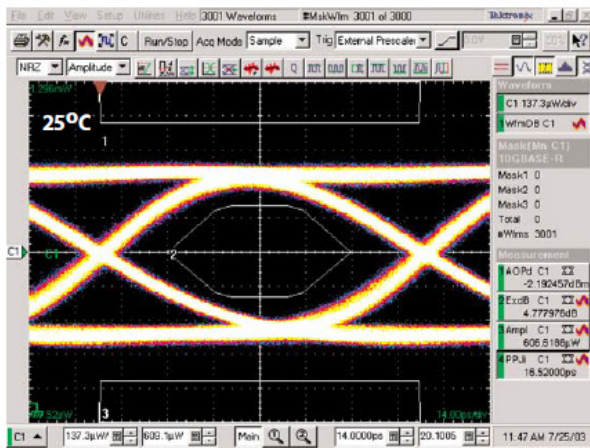
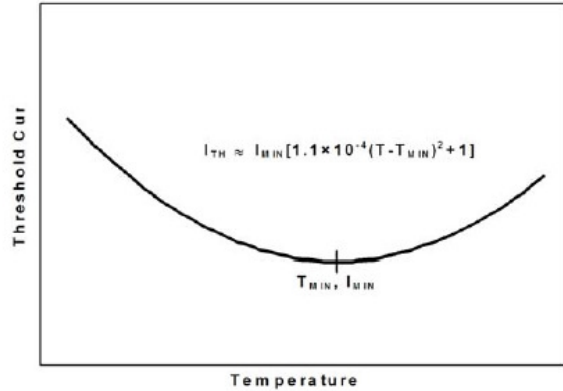

**IV. Environmental Specifications**

Parameter	Symbol	Min	Typ	Max	Units	Ref.
Case Operating Temperature	T <sub>op</sub>	0		85	°C	
Storage Temperature	T <sub>sto</sub>	-40		85	°C	

**V. Regulatory Compliance**

Feature	Agency	Standard	Certificate Number
Laser Eye Safety	FDA/CDRH	CDRH 21 CFR 1040 and Laser Notice 50	9521487

Copies of the referenced certificates are available at Finisar Corporation upon request.

**VI. Mechanical Specifications**

PIN	Description
1	PDK
2	GND
3	LDA
4	LDK
5	GND
6	PDA

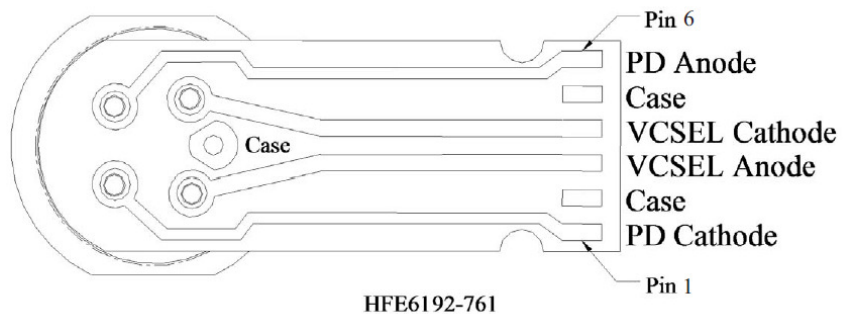

LC TOSA  
All dimensions in mm

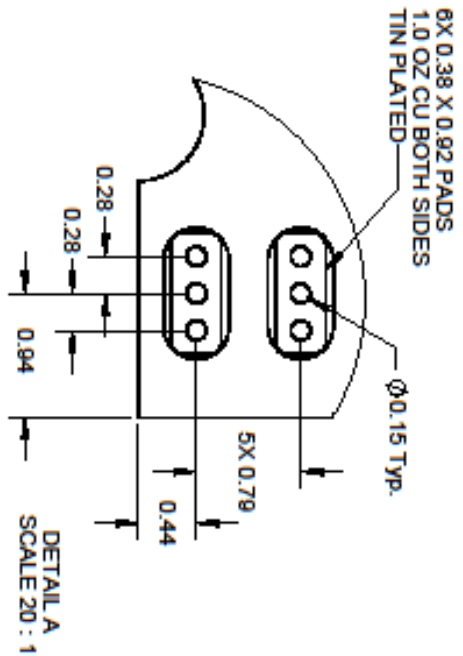
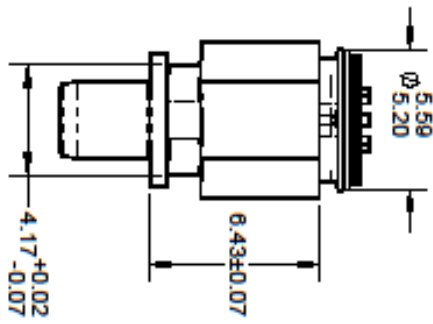
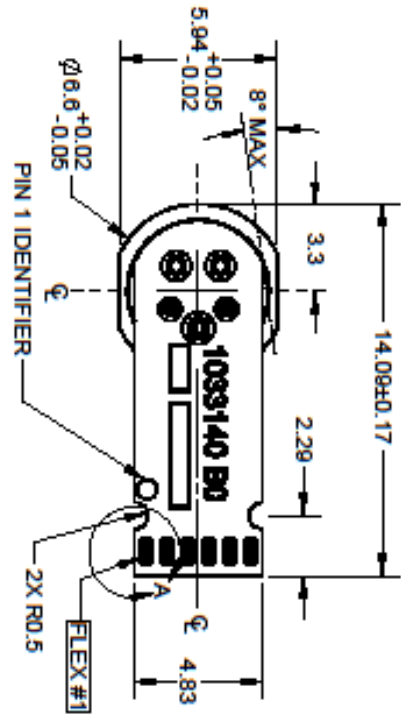
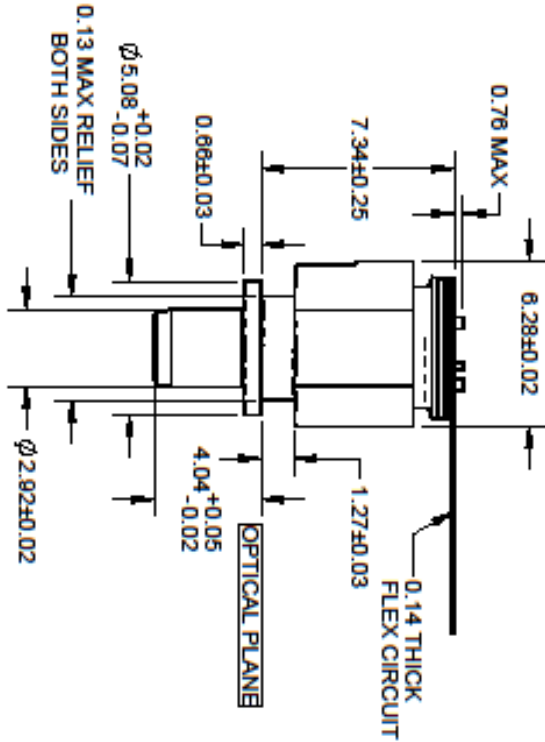

SC TOSA  
All dimensions in mm

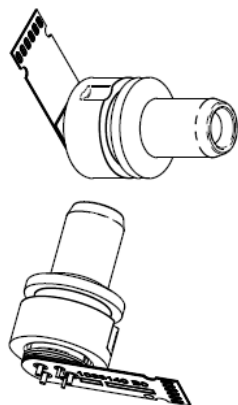
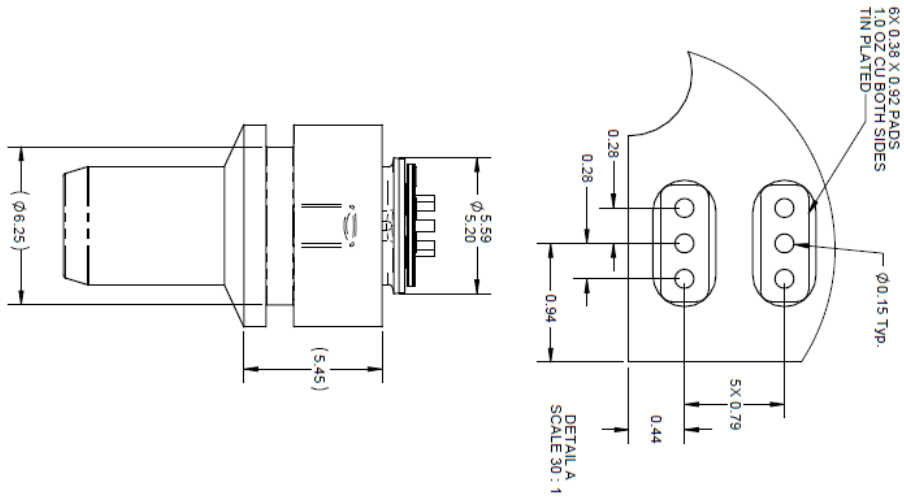
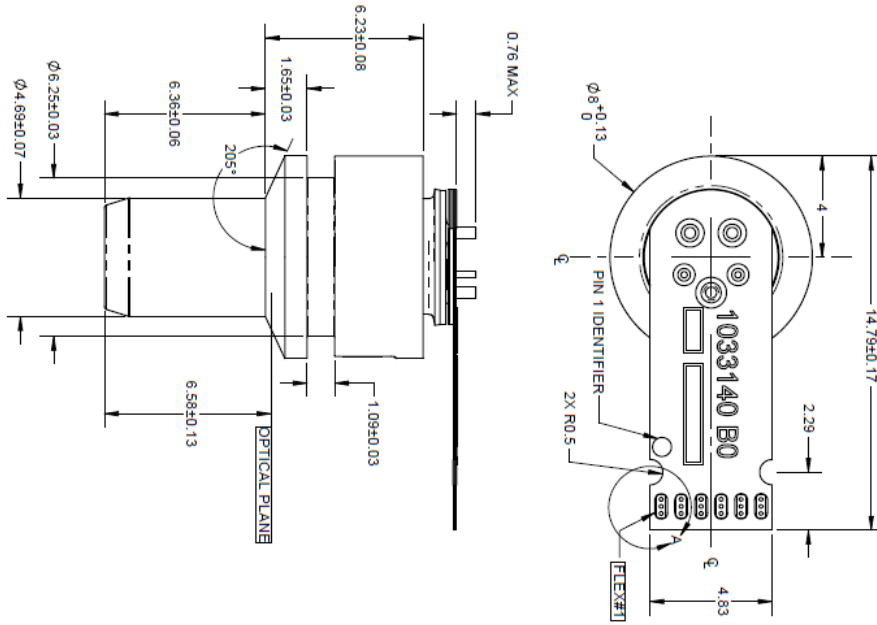

**VII. Revision History**

<b>Revision</b>	<b>Date</b>	<b>Description</b>
B00	8/14/2014	<ul style="list-style-type: none"><li>• Changed to Finisar format</li></ul>
B01	12/3/2014	<ul style="list-style-type: none"><li>• Changed limits for Vf and SE (Vf max reduced to 2.2V and SE min raised to 0.06)</li></ul>

**VIII. For More Information**

Finisar Corporation  
1389 Moffett Park Drive  
Sunnyvale, CA 94089-1133  
Tel. 1-408-548-1000  
Fax 1-408-541-6138  
[sales@finisar.com](mailto:sales@finisar.com)  
[www.finisar.com](http://www.finisar.com)