

42□ 0.9°

17PY-Z

0.9°

■ 外観図 Outline

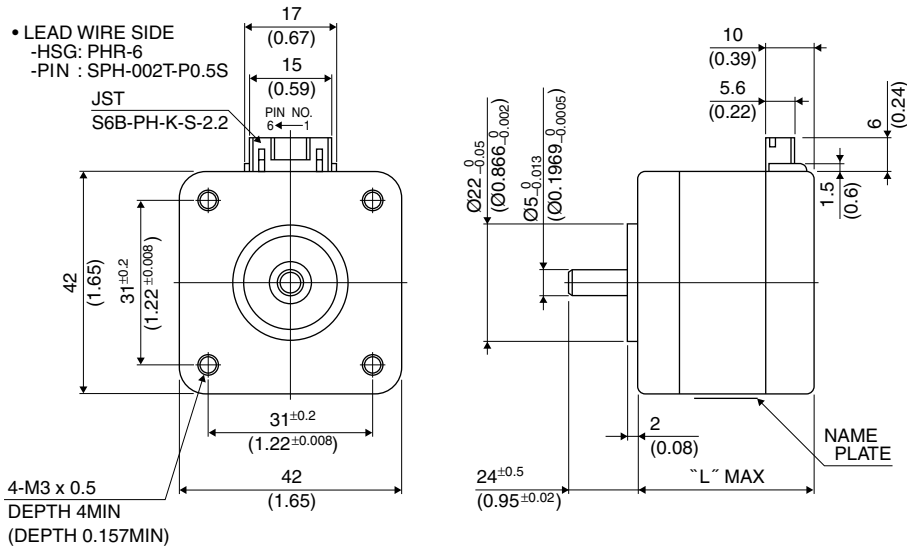

Hybrid

UNIT: mm
(inch)

	"L"
17PY-Z7**	26 (1.02)
17PY-Z2**	30 (1.18)
17PY-Z0**	34 (1.34)
17PY-Z3**	38 (1.50)
17PY-Z1**	42 (1.65)
17PY-Z4**	48 (1.89)

結線表 PIN NO. vs. PHASE

相 (PHASE)	A	A COM	\bar{A}	B	B COM	\bar{B}
ピン番号 (PIN NO.)	4	5	6	3	2	1

■ 仕様 Specifications

型式	ステップ角	ドライブ方式	定格電流	巻線抵抗	ホールディングトルク	インダクタンス	ロータイナーシャ	ディテントトルク	質量
Model	Step Angle	Drive Sequence	Rated Current	Resistance	Holding Torque	Inductance	Rotor Inertia	Detent Torque	Mass
	(deg)		(A)	(Ohms)	(mNm)	(mH)	(g·cm ²)	(mNm)	(g)
17PY-Z049U	0.9	UNI-POLAR	1.0	3.1	220	4.4	37	11.0	200
17PY-Z064U	0.9	UNI-POLAR	0.6	8.3	220	11.1	37	11.0	200
17PY-Z142U	0.9	UNI-POLAR	1.4	2.3	300	4.7	62	11.8	300
17PY-Z149U	0.9	UNI-POLAR	1.0	4.3	300	8.7	62	11.8	300
17PY-Z249U	0.9	UNI-POLAR	0.8	2.7	120	3.8	24	4.4	180
17PY-Z264U	0.9	UNI-POLAR	0.6	6.9	120	9.7	24	4.4	180
17PY-Z342U	0.9	UNI-POLAR	1.4	2.0	280	3.5	50	12.0	250
17PY-Z349U	0.9	UNI-POLAR	1.0	3.6	280	6.5	50	12.0	250
17PY-Z442U	0.9	UNI-POLAR	1.4	2.8	450	4.5	75	18.7	350
17PY-Z449U	0.9	UNI-POLAR	1.0	4.9	450	8.4	75	18.7	350
17PY-Z749U	0.9	UNI-POLAR	0.9	2.2	48	1.9	11	3.0	150
17PY-Z764U	0.9	UNI-POLAR	0.6	5.6	48	4.9	11	3.0	150
17PY-Z049B	0.9	BI-POLAR	0.7	6.2	270	17.5	37	11.0	200
17PY-Z142B	0.9	BI-POLAR	1.0	4.6	390	18.6	62	11.8	300
17PY-Z249B	0.9	BI-POLAR	0.6	5.4	160	15.2	24	4.4	180
17PY-Z342B	0.9	BI-POLAR	0.9	4.0	340	13.8	50	12.0	250
17PY-Z442B	0.9	BI-POLAR	0.9	5.6	540	18.0	75	18.7	350
17PY-Z749B	0.9	BI-POLAR	0.6	4.4	63	7.8	11	3.0	150

■ トルク・スピード特性 Torque/Speed Characteristics

Model No: 17PY-Z049U,Z064U
Driver: Chopper Dual
Supply Voltage: 24.0 (Volt)

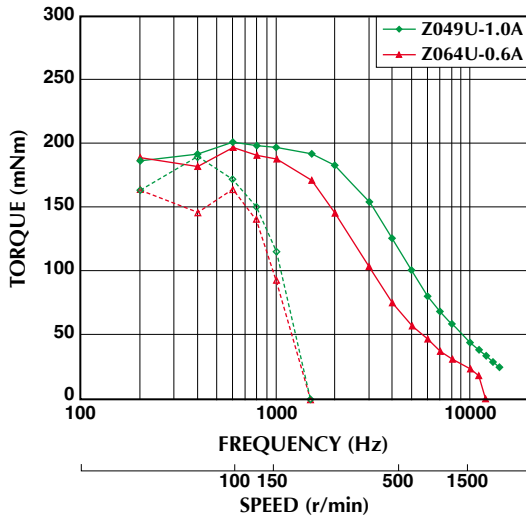

Model No: 17PY-Z049B
Driver: Chopper Dual
Supply Voltage: 24.0 (Volt)

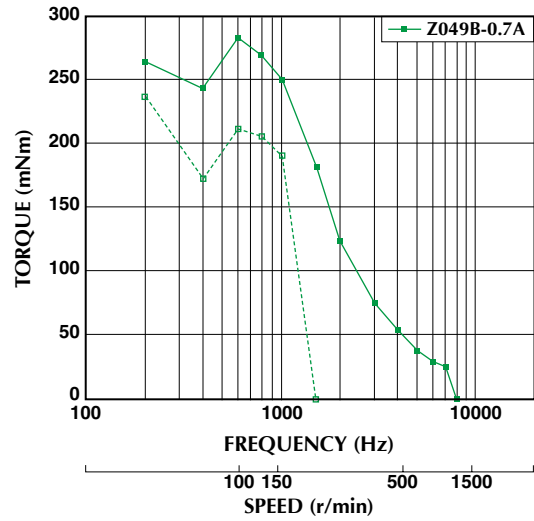

Model No: 17PY-Z142U,Z149U
Driver: Chopper Dual
Supply Voltage: 24.0 (Volt)

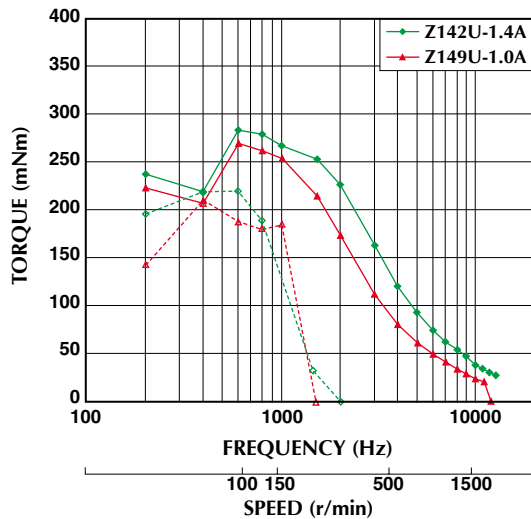

Model No: 17PY-Z142B
Driver: Chopper Dual
Supply Voltage: 24.0 (Volt)

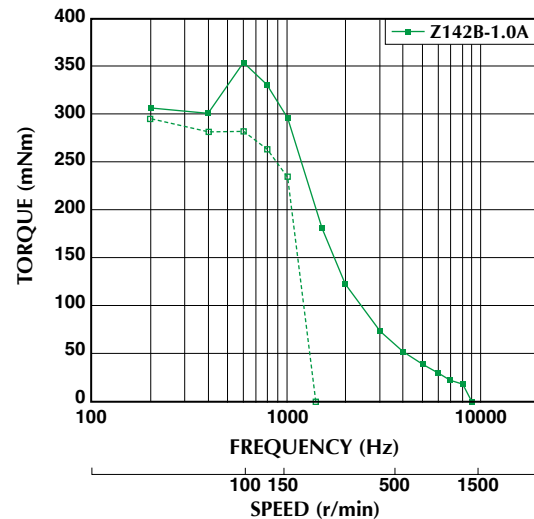

Model No: 17PY-Z249U,Z264U
Driver: Chopper Dual
Supply Voltage: 24.0 (Volt)

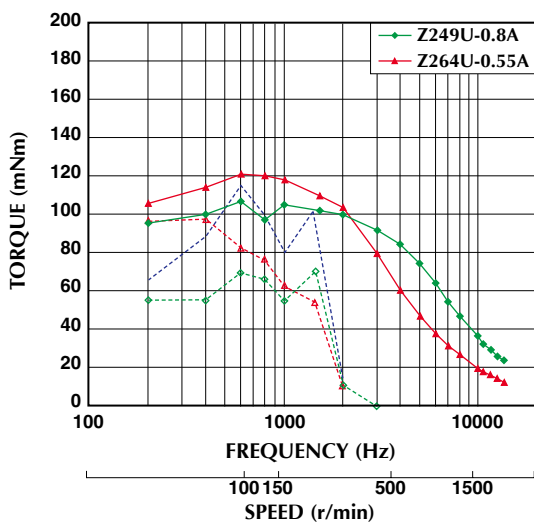

Model No: 17PY-Z249B
Driver: Chopper Dual
Supply Voltage: 24.0 (Volt)

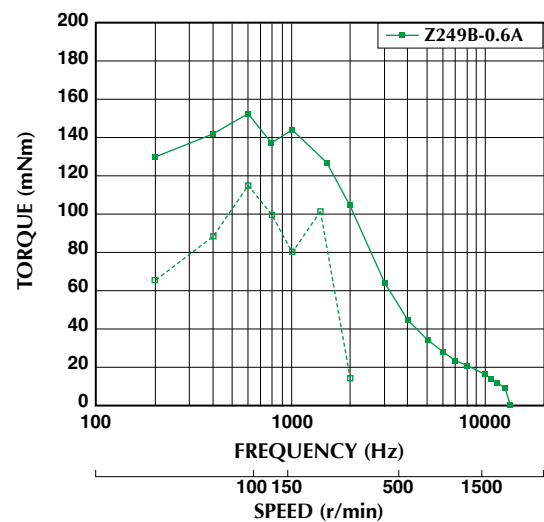

■ トルク特性は当社測定による参考データで、保証値ではありません。また、条件が変化すると、特性が変化する場合があります。
■ Torque/Speed characteristics are for reference only and it may change when operated at different drive conditions.

■ このカタログに掲載している製品の性能及び仕様は、改良の為予告なく変更することがありますのでご了承ください。
■ Specifications are subject to change without notice.

— : PULL OUT
- - - : PULL IN

■ トルク・スピード特性 Torque/Speed Characteristics

Model No: 17PY-Z342U,Z349U
Driver: Chopper Dual
Supply Voltage: 24.0 (Volt)

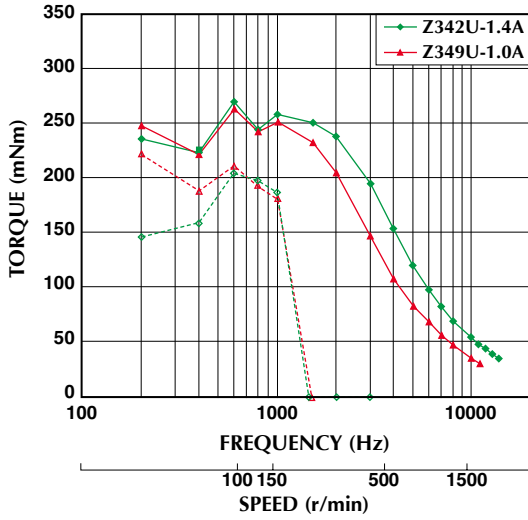

Model No: 17PY-Z342B
Driver: Chopper Dual
Supply Voltage: 24.0 (Volt)

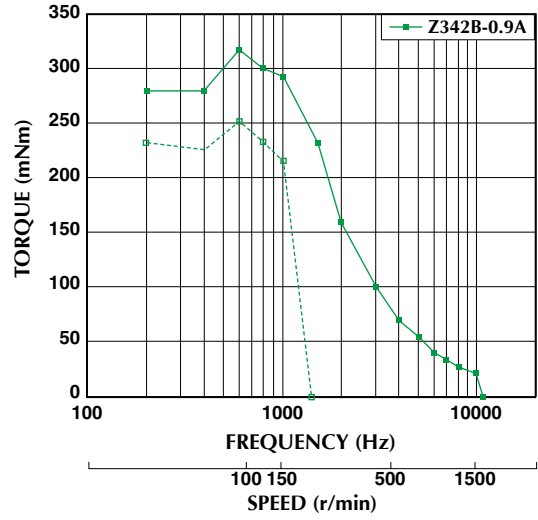

Model No: 17PY-Z442U,Z449U
Driver: Chopper Dual
Supply Voltage: 24.0 (Volt)

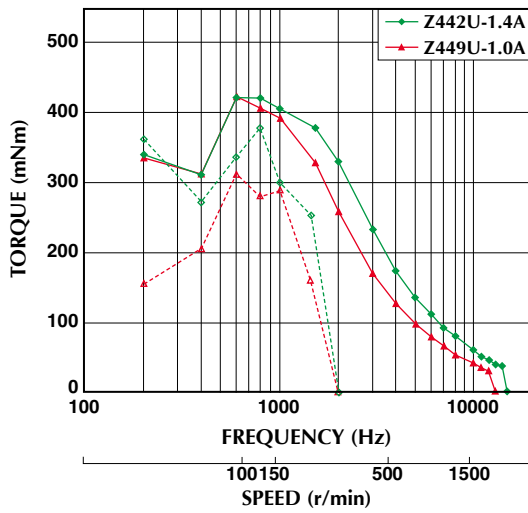

Model No: 17PY-Z442B
Driver: Chopper Dual
Supply Voltage: 24.0 (Volt)

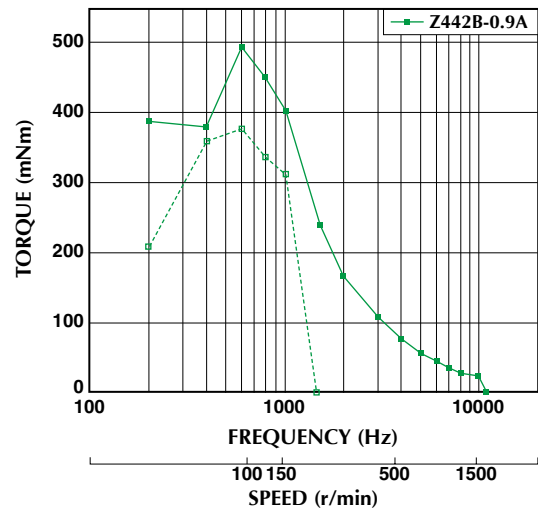

Model No: 17PY-Z749U,Z764U
Driver: Chopper Dual
Supply Voltage: 24.0 (Volt)

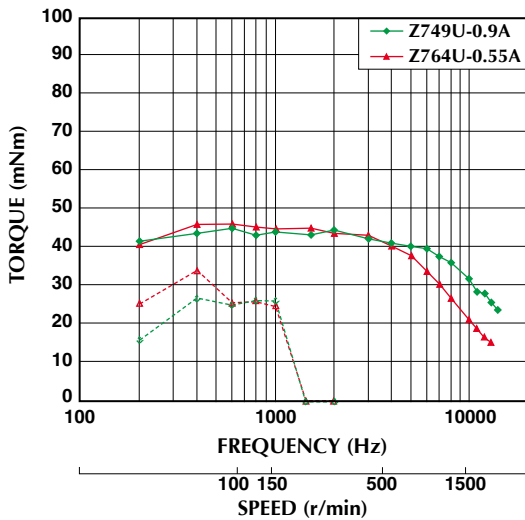

Model No: 17PY-Z749B
Driver: Chopper Dual
Supply Voltage: 24.0 (Volt)

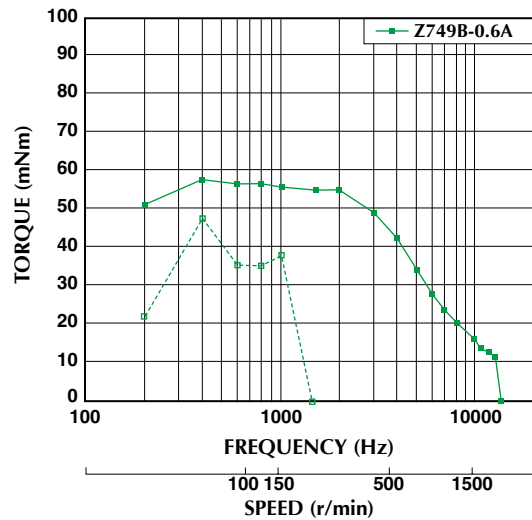

■ トルク特性は当社測定による参考データで、保証値ではありません。また、条件が変化すると、特性が変化する場合があります。
■ Torque/Speed characteristics are for reference only and it may change when operated at different drive conditions.

■ このカタログに掲載している製品の性能及び仕様は、改良の為予告なく変更することがありますのでご了承ください。
■ Specifications are subject to change without notice.

— : PULL OUT
- - - : PULL IN