



Photointerrupter Product Data Sheet

LTH-301-05

Spec No.: DS-55-92-0002

Effective Date: 06/29/2000

Revision: -

LITE-ON DCC

RELEASE

BNS-OD-FC001/A4

FEATURES

- * NON-CONTACT SWITCHING.
- * FOR DIRECT PC BOARD OR DUAL-IN-LINE SOCKET MOUNTING.
- * FAST SWITCHING SPEED.

PACKAGE DIMENSIONS

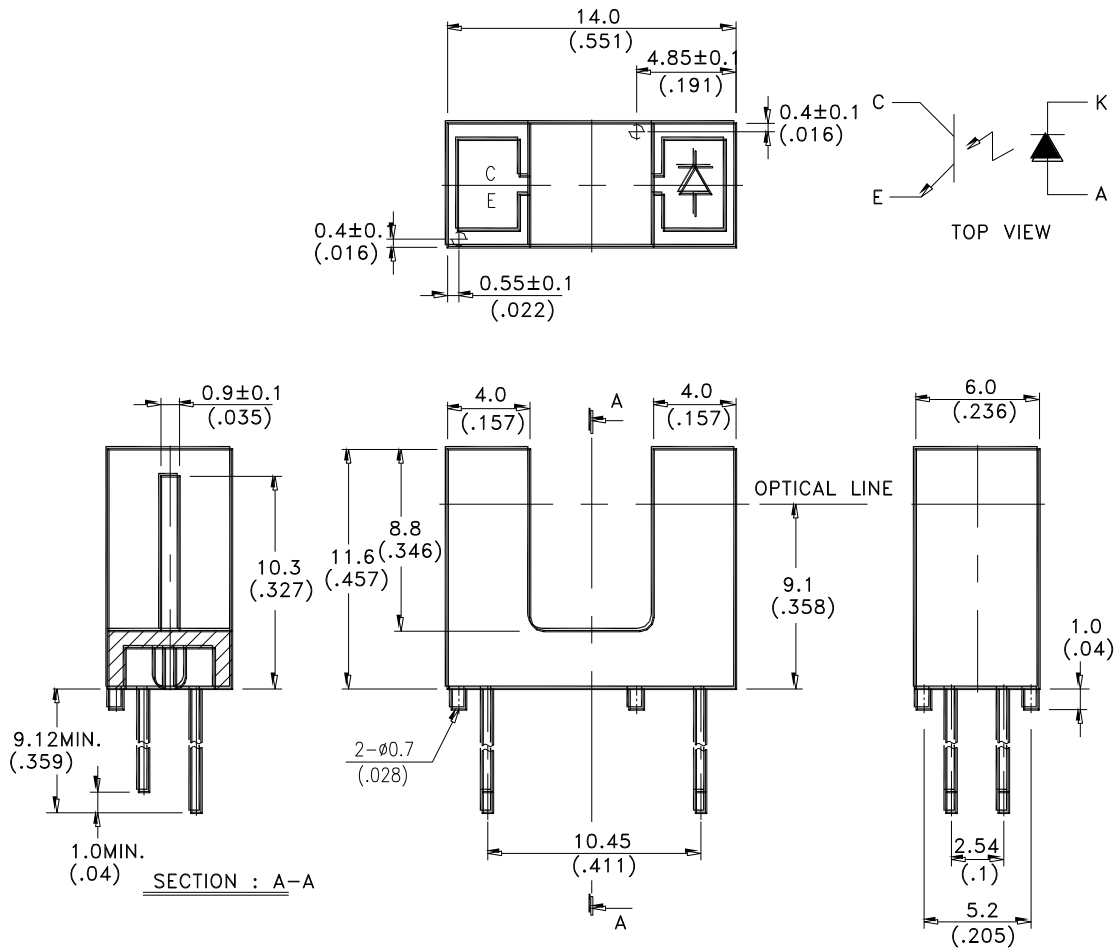

NOTES:

1. All dimensions are in millimeters (inches).
2. Tolerance is ±0.25mm(.010") unless otherwise noted.

ABSOLUTE MAXIMUM RATINGS AT T_A=25°C

PARAMETER	MAXIMUM RATING	UNIT
IR Diode Continuous Forward Current	60	mA
IR Diode Reverse Voltage	5	V
Transistor Collector Current	20	mA
Transistor Power Dissipation	75	mW
IR Diode Peak Forward Current (Pulse Wide = 10 μ S, 300 pps)	1	A
Diode Power Dissipation	100	mW
Phototransistor Collector-Emitter Voltage	30	V
Phototransistor Emitter-Collector Voltage	5	V
Operating Temperature Range	-25°C to + 85°C	
Storage Temperature Range	-40°C to + 100°C	
Lead Soldering Temperature [1.6mm(.063") From Case]	260°C for 5 Seconds	

ELECTRICAL OPTICAL CHARACTERISTICS AT TA=25°C

PARAMETER	SYMBOL	MIN.	TYP.	MAX.	UNIT	TEST CONDITION
INPUT LED						
Forward Voltage	V _F		1.2	1.6	V	I _F = 20mA
Reverse Current	I _R			100	μA	V _R =5V
OUTPUT PHOTOTRANSISTOR						
Collector-Emitter Breakdown Voltage	V(BR) _{CEO}	30			V	I _C =1mA
Emitter-Collector Breakdown Voltage	V(BR) _{ECO}	5			V	I _E =100 μA
Collector-Emitter Dark Current	I _{CEO}			100	nA	V _{CE} =10V
COUPLER						
Collector-Emitter Saturation Voltage	V _{CE(SAT)}			0.4	V	I _C =0.25mA I _F =20mA
On State Collector Current	I _{c(ON)}	0.5			mA	V _{CE} =5V I _F =20mA
Response Time	Rise Time	t _r	3	15	μS	V _{CE} =5V, I _c =2mA R _L =100Ω
	Fall Time	t _f	4	20		

TYPICAL ELECTRICAL / OPTICAL CHARACTERISTICS CURVES

(25°C Ambient Temperature Unless Otherwise Noted)

Fig.1 Power Dissipation vs. Ambient Temperature

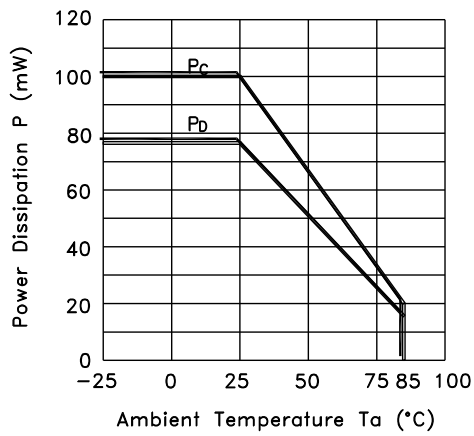

Fig.2 Forward Current vs. Forward Voltage

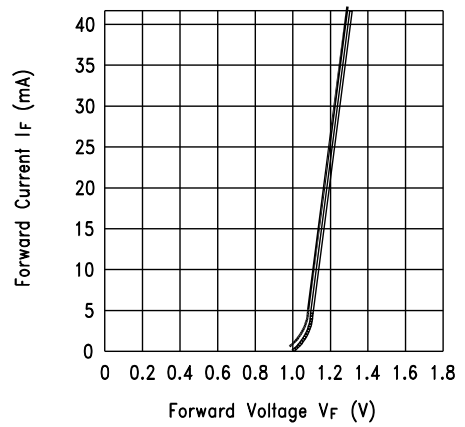

Fig.3 Collector Current vs. Collector-emitter Voltage

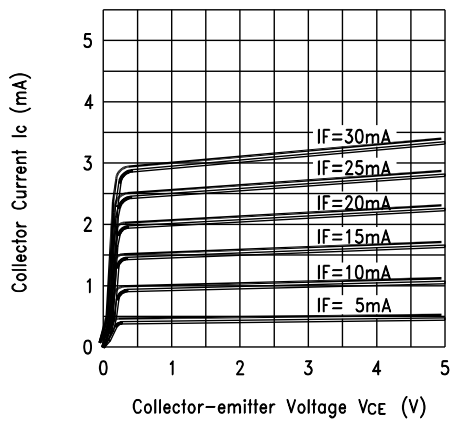
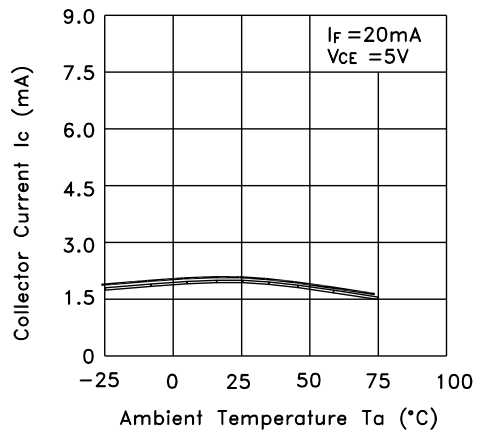

Fig.4 Collector Current vs. Ambient Temperature



TYPICAL ELECTRICAL / OPTICAL CHARACTERISTICS CURVES

(25°C Ambient Temperature Unless Otherwise Noted)

Fig.5 Collector-emitter Saturation Voltage vs. Ambient Temperature

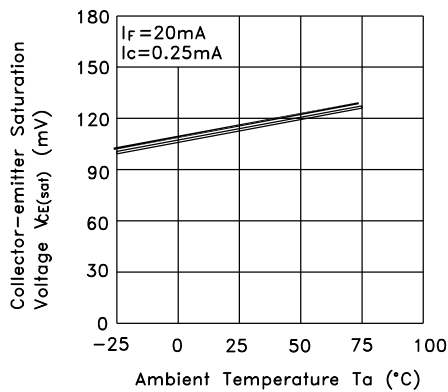
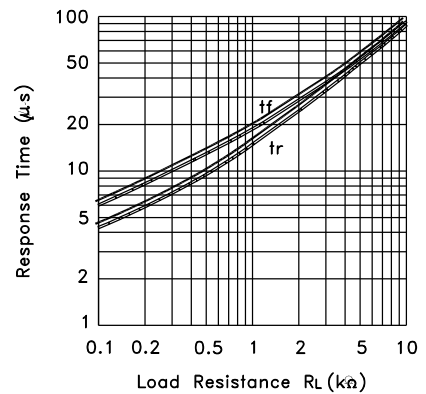

Fig.6 Response Time vs. Load Resistance



Test Circuit for Response Time

