

9 & 15 POSITION

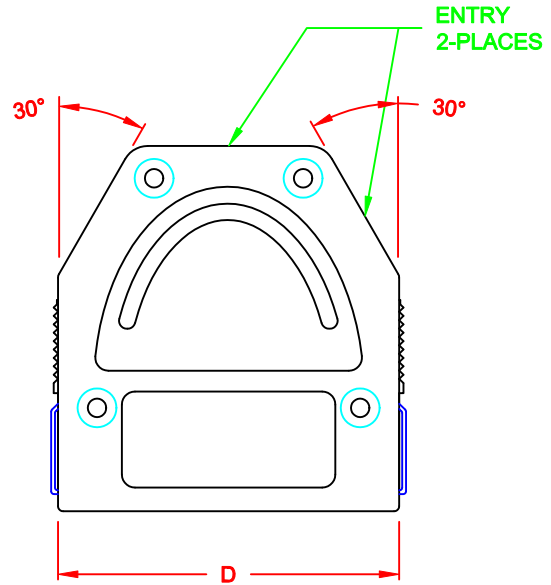

25 POSITION

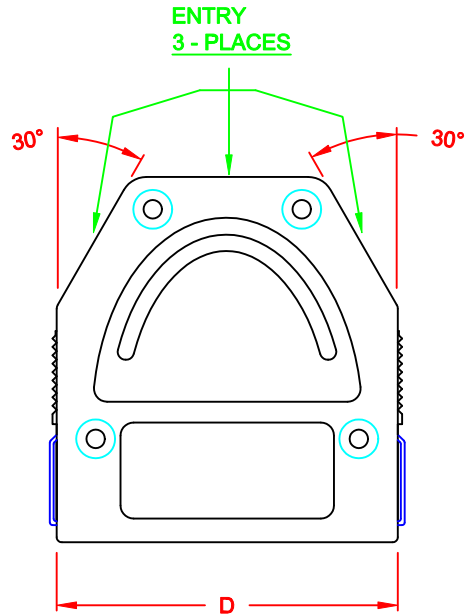

37 POSITION

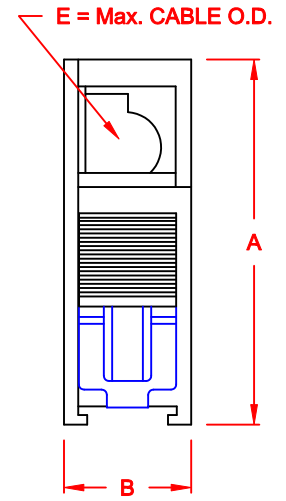

SPECIFICATION:

- MATERIAL
- BLACK PLASTIC: ABS PLASTIC, SICOFLEX, UL 94 V-0
- METALIZED PLASTIC: NICKEL OVER COPPER PLATING
- TEMP RATING: -55°C to +125°C

BACKSHELL KIT INCLUDES:

- (2) BACKSHELL HALVES
- (4) MOUNTING SCREWS
- (1) STRAIN RELIEF CLAMP
- (2) STRAIN RELIEF SCREWS

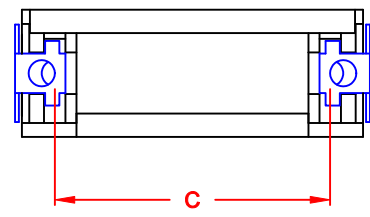

DIMENSIONS (IN.)					
No. OF PINS	A	B	C	D	E
09	1.740	0.606	0.984	1.299	0.354
15	1.740	0.606	1.312	1.626	0.394
25	1.740	0.606	1.852	2.165	0.433
37	1.740	0.606	2.500	2.815	0.433

955-YYY-YYYRYY1

- SERIES _____
- POSITIONS _____
- 009 _____
- 015 _____
- 025 _____
- 037 _____
- MATERIAL _____
- 010 = PLASTIC
- 020 = METALIZED PLASTIC
- RoHS COMPLIANT _____
- R = HIGH TEMP. PROCESS
- COLOR _____
- 01 = BLACK
- 12 = METAL(IZED)
- PUT-UP _____
- 1 = KIT

DO NOT SCALE FROM DRAWING

	THESE DRAWINGS AND SPECIFICATIONS ARE THE PROPERTY OF NorComp AND SHALL NOT BE REPRODUCED, COPIED OR USED AS THE BASIS FOR THE MANUFACTURE OF SALE OF APPARATUS WITHOUT WRITTEN PERMISSION.		DRAWN: C. SMITH	DATE: 04-10-07
			CHECKED:	DATE:
NorComp	SCALE: 1 : 1	SHEET 1	OF 2	REV 3
	DWG NO. 955-YYY-YYYRYY1			

RoHS COMPLIANT

CABLE CLAMPS ORDERED SEPARATELY

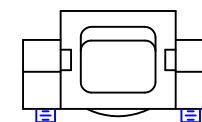
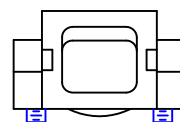
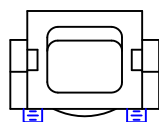
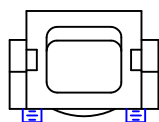
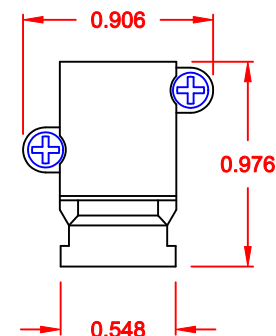
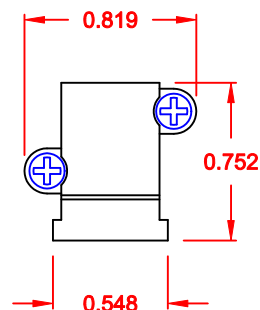
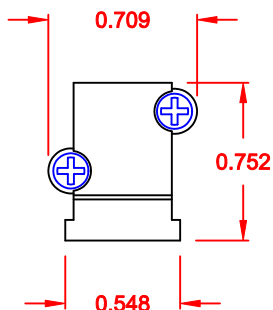
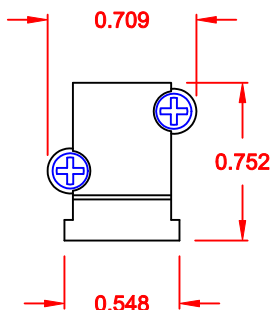
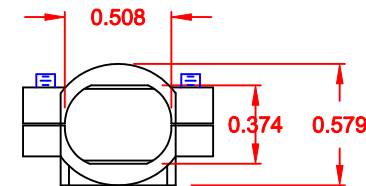
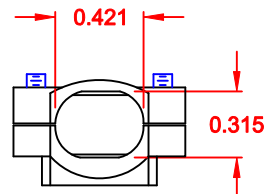
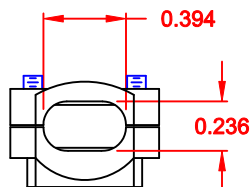
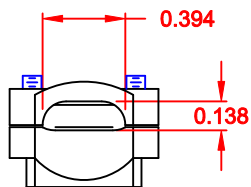

P/N 955-09-SR-4-7
CABLE RANGE = 0.157 - 0.276

P/N 955-15-SR-7-10
CABLE RANGE = 0.276 - 0.394

P/N 955-25-SR-9-12
CABLE RANGE = 0.354 - 0.472

P/N 955-37-SR-11-14
CABLE RANGE = 0.433 - 0.551

DO NOT SCALE FROM DRAWING



THESE DRAWINGS AND SPECIFICATIONS ARE THE PROPERTY OF NorComp AND SHALL NOT BE REPRODUCED, COPIED OR USED AS THE BASIS FOR THE MANUFACTURE OF SALE OF APPARATUS WITHOUT WRITTEN PERMISSION.

DRAWN:
C. SMITH

DATE:
04-10-07

CHECKED:

DATE:

NorComp

SCALE: 1 : 1 SHEET 2 OF 2 REV 3

DWG NO. **955-YYY-YYYRYY1**

RoHS COMPLIANT