

**PACKAGE DIMENSIONS**

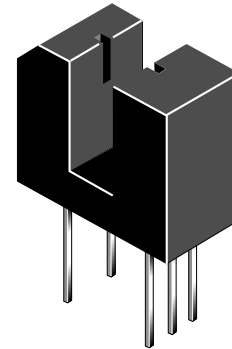
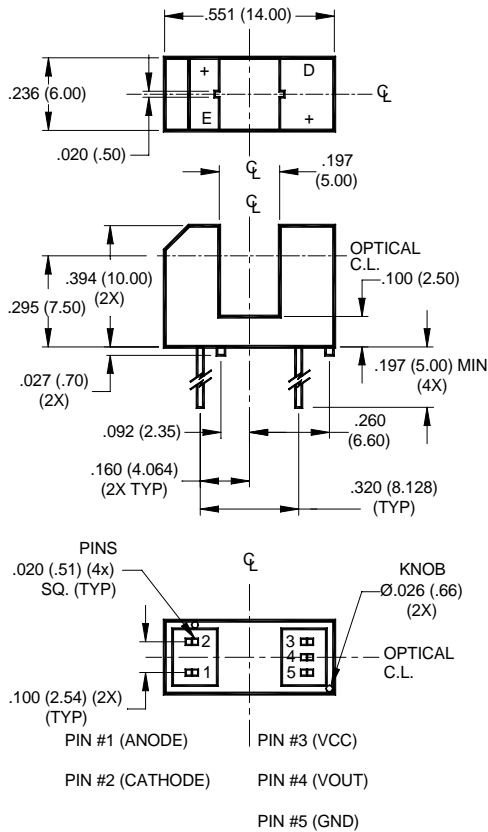

**FEATURES**

- No contact switching
- 5.0 mm wide slot
- 0.5 mm aperture width
- Opaque black plastic housing
- Output configuration: Buffer open-collector
- TTL/CMOS compatible output
- Locating knobs on housing base for accurate mounting

**NOTES** (Applies to Max Ratings and Characteristics Tables.)

1. Derate power dissipation linearly 1.67 mW/°C above 25°C.
2. Derate power dissipation linearly 2.50 mW/°C above 25°C.
3. RMA flux is recommended.
4. Methanol or isopropyl alcohols are recommended as cleaning agents.
5. Soldering iron 1/16" (1.6mm) from housing.
6. As long as leads are not under any stress or spring tension.

**NOTES:**

1. Dimensions for all drawings are in inches (millimeters).
2. Tolerance of  $\pm .010$  (.25) on all non-nominal dimensions unless otherwise specified.

**ABSOLUTE MAXIMUM RATINGS** ( $T_A = 25^\circ\text{C}$  unless otherwise specified)

Parameter	Symbol	Rating	Units
Operating Temperature	$T_{OPR}$	-40 to +85	°C
Storage Temperature	$T_{STG}$	-40 to +85	°C
Lead Temperature (Solder Iron) <sup>(3,4,5,6)</sup>	$T_{SOL-I}$	240 for 5 sec	°C
Lead Temperature (Solder Flow) <sup>(3,4,5,6)</sup>	$T_{SOL-F}$	260 for 10 sec	°C
<b>EMITTER</b>			
Continuous Forward Current	$I_F$	50	mA
Reverse Voltage	$V_R$	5	V
Power Dissipation <sup>(1)</sup>	$P_D$	100	mW
<b>SENSOR</b>			
Output Current	$I_O$	50	mA
Supply Voltage	$V_{CC}$	16	V
Output Voltage	$V_O$	30	V
Power Dissipation <sup>(2)</sup>	$P_D$	150	mW

ELECTRICAL / OPTICAL CHARACTERISTICS (T <sub>A</sub> = 25°C)						
PARAMETER	TEST CONDITIONS	SYMBOL	MIN.	TYP.	MAX.	UNITS
Operating Supply Voltage		V <sub>CC</sub>	4.5		16	V
<b>INPUT DIODE</b>						
Forward Voltage	I <sub>F</sub> = 20 mA	V <sub>F</sub>	—		1.7	V
Reverse Leakage Current	V <sub>R</sub> = 5 V	I <sub>R</sub>	—		10	μA
<b>COUPLED</b>						
Operating Supply Current	I <sub>F</sub> = 15 mA or 0 mA, V <sub>CC</sub> = 16 V	I <sub>CC</sub>	—		5	mA
Low Level Output Voltage	I <sub>F</sub> = 15 mA, V <sub>CC</sub> = 5 V, R <sub>L</sub> = 360 Ω	V <sub>OL</sub>	—		0.4	V
High Level Output Current	I <sub>F</sub> = 0 mA, V <sub>CC</sub> = 5 V, V <sub>OH</sub> = 30 V	I <sub>OH</sub>	—		100	μA
Turn on Threshold Current	V <sub>CC</sub> = 5 V, R <sub>L</sub> = 360 Ω	I <sub>F</sub> (+)	—		15	mA
Turn off Threshold Current	V <sub>CC</sub> = 5 V, R <sub>L</sub> = 360 Ω	I <sub>F</sub> (-)	0.50		—	mA
Hysteresis Ratio		I <sub>F</sub> (+) / I <sub>F</sub> (-)		1.2		
Propagation Delay	V <sub>CC</sub> = 5 V, R <sub>L</sub> = 360 Ω	t <sub>PLH</sub> , t <sub>PHL</sub>		5		μs
Output Rise and Fall Time	V <sub>CC</sub> = 5 V, R <sub>L</sub> = 360 Ω	t <sub>r</sub> , t <sub>f</sub>		70		ns

**TYPICAL PERFORMANCE CURVES**

**Fig. 1 Output Voltage vs. Input Current**

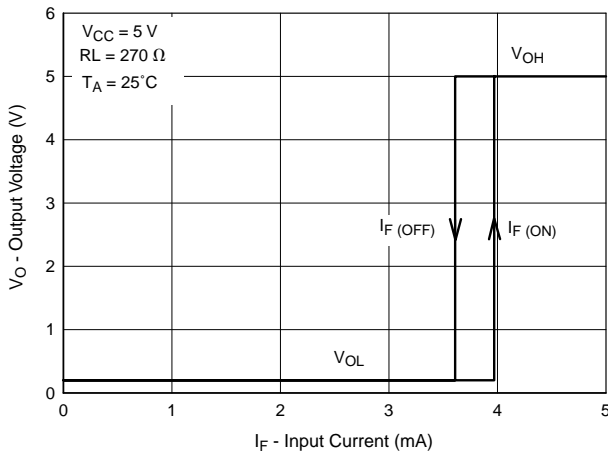

**Fig. 2 Normalized Threshold Current vs. Shield Distance**

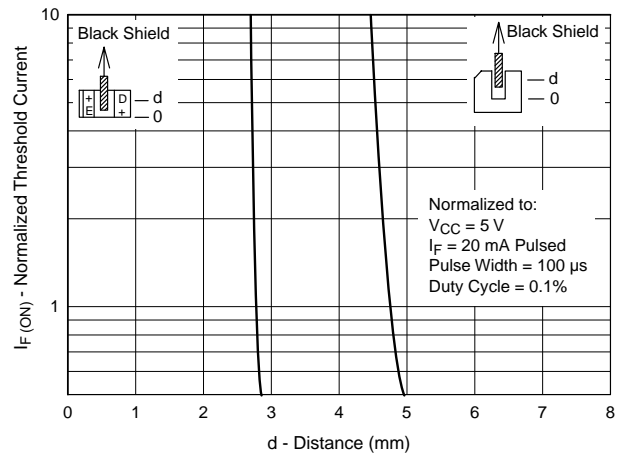

**Fig. 3 Normalized Threshold Current vs. Supply Voltage**

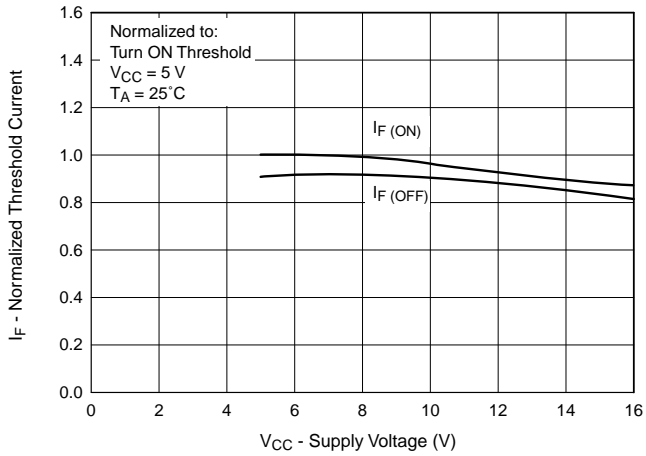

**Fig. 4 Normalized Threshold Current vs. Ambient Temperature**

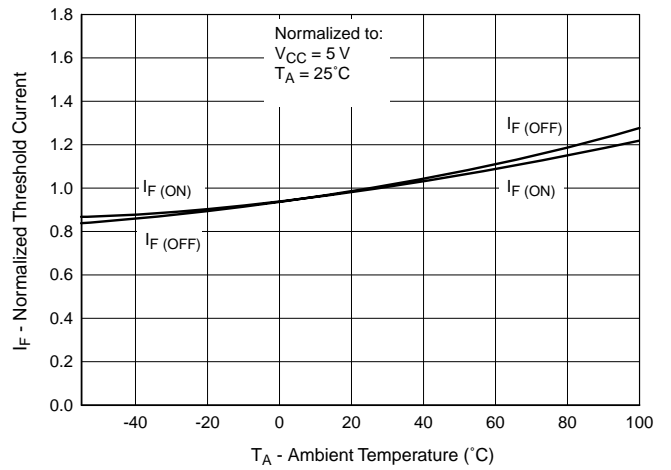

**Fig. 5 Forward Current vs. Forward Voltage**

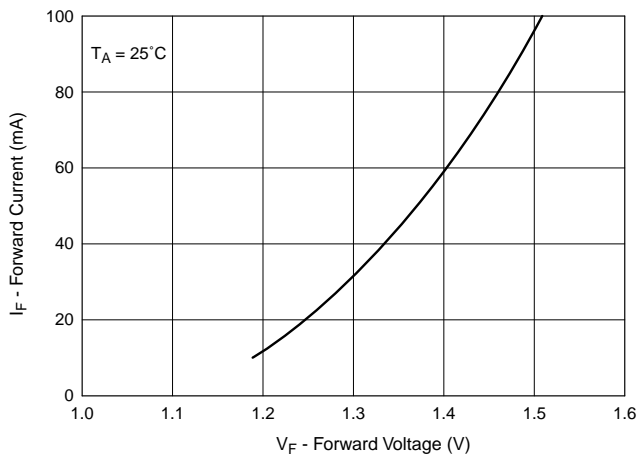

**Fig. 6 Low Output Voltage vs. Output Current**

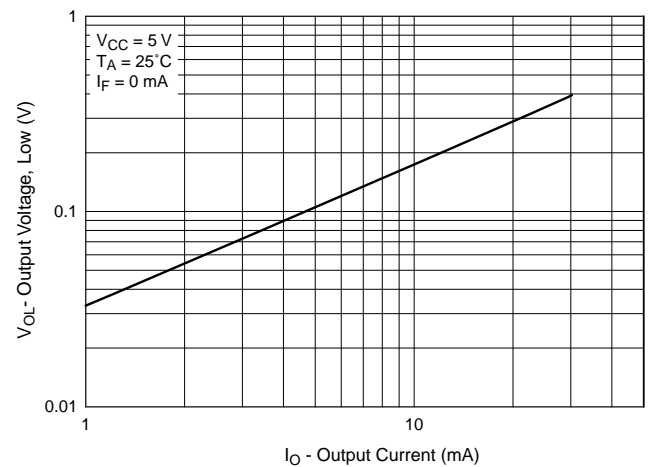

**Fig. 7 Response Time vs. Forward Current**

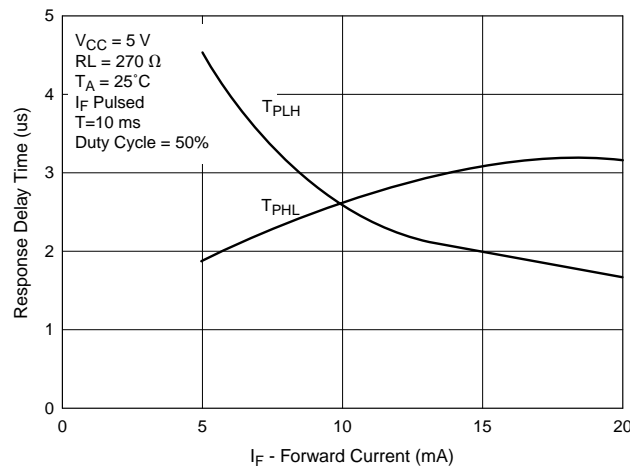
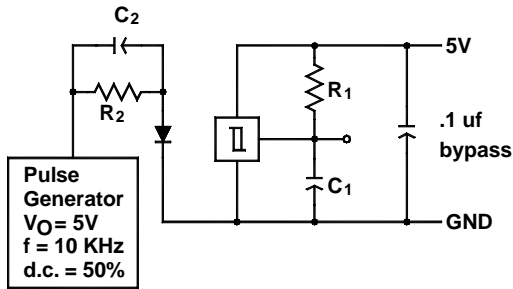

Fig. 8 Switching Speed Test Circuit



$R_1 = 270 \ \Omega$   
 $R_2 = 360 \ \Omega$

$C_1 = 15 \text{ pf}$   
 $C_2 = 20 \text{ pf}$

$C_1$  and  $C_2$  include probe and  
stray wire capacitance

Fig. 9 Typical Operating Circuit

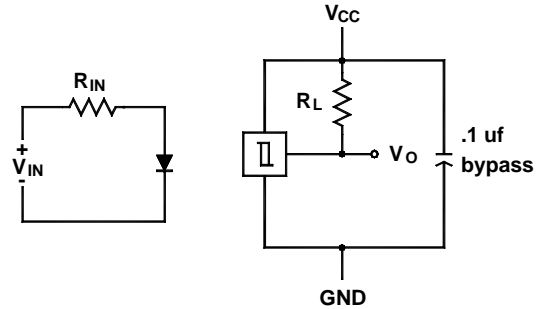

Fig. 10 Switching Test Curve for Buffers

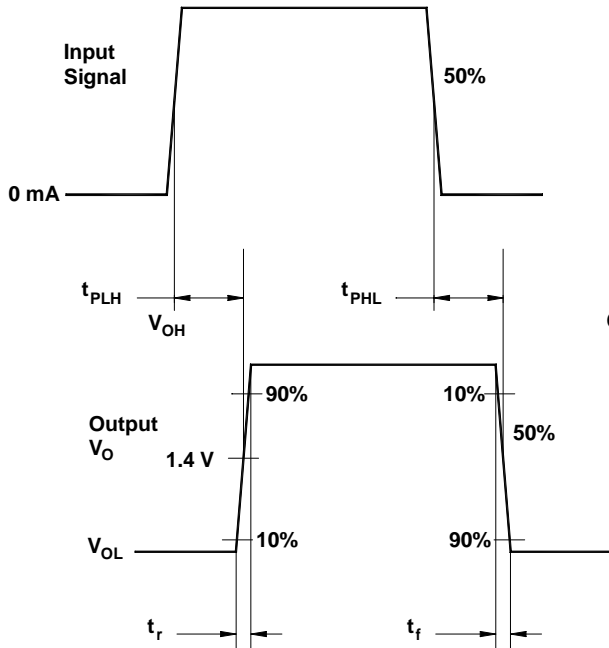
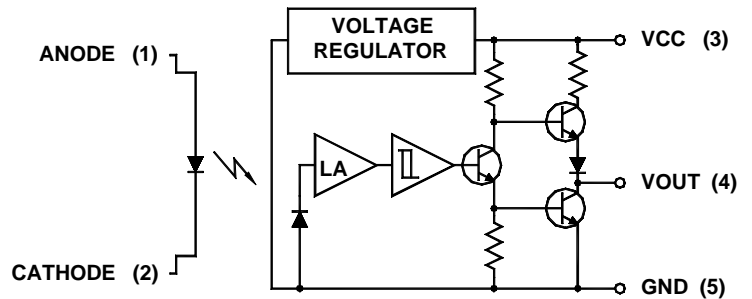

Fig. 11 Switching Test Curve for Inverters



### DISCLAIMER

FAIRCHILD SEMICONDUCTOR RESERVES THE RIGHT TO MAKE CHANGES WITHOUT FURTHER NOTICE TO ANY PRODUCTS HEREIN TO IMPROVE RELIABILITY, FUNCTION OR DESIGN. FAIRCHILD DOES NOT ASSUME ANY LIABILITY ARISING OUT OF THE APPLICATION OR USE OF ANY PRODUCT OR CIRCUIT DESCRIBED HEREIN; NEITHER DOES IT CONVEY ANY LICENSE UNDER ITS PATENT RIGHTS, NOR THE RIGHTS OF OTHERS.

### LIFE SUPPORT POLICY

FAIRCHILD'S PRODUCTS ARE NOT AUTHORIZED FOR USE AS CRITICAL COMPONENTS IN LIFE SUPPORT DEVICES OR SYSTEMS WITHOUT THE EXPRESS WRITTEN APPROVAL OF THE PRESIDENT OF FAIRCHILD SEMICONDUCTOR CORPORATION. As used herein:

1. Life support devices or systems are devices or systems which, (a) are intended for surgical implant into the body, or (b) support or sustain life, and (c) whose failure to perform when properly used in accordance with instructions for use provided in the labeling, can be reasonably expected to result in a significant injury of the user.
2. A critical component in any component of a life support device or system whose failure to perform can be reasonably expected to cause the failure of the life support device or system, or to affect its safety or effectiveness.