

1.7mm pitch, Low Profile Wire-to-Board Connectors for Power Supplies

DF65 Series

(UL, C-UL, Listed)

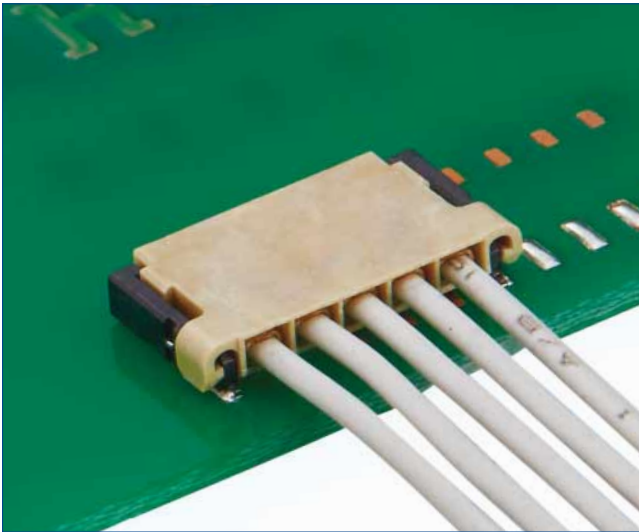

Features

1. Enhanced contact reliability and lock structure

The unique locking structure reinforces the engagement between the wire side portion and the header. This prevents the wire side from becoming misaligned due to stress from poorly routed wiring. (Fig.1) (Patented)

2. Vertical mating provides superior handling

The use of vertical mating style reduces assembly time and maximizes precious board space which gives designers more freedom when designing other components on the PCB. (Fig.2)

3. Highly reliable contact structure

The two point contact structure provides optimum reliability, a low mated height of 1.8mm and an effective mating length of 0.35mm.

4. Increased cable retention

The header is designed to press the terminal lance down during the mating operation; this prevents the lance from moving and enhances its strength.

5. High current of MAX 4A (24 AWG)

By utilizing highly conductive material for the female terminals and suppressing the contact resistance, the DF65 series can handle a maximum of 4A with 24 AWG wire.

6. Solder wicking prevention

Molding is done in a way that removes the gap between the contacts and the housing to prevent wicking.

7. Prevents Accidental unmating

The molded structure is designed to prevent accidental unmating due to poorly routed wiring and harsh loads.

8. UL and C-UL Certified

9. Glow Wire compliance (Compliant with IEC 60695-2-11)

Lock structure and operation

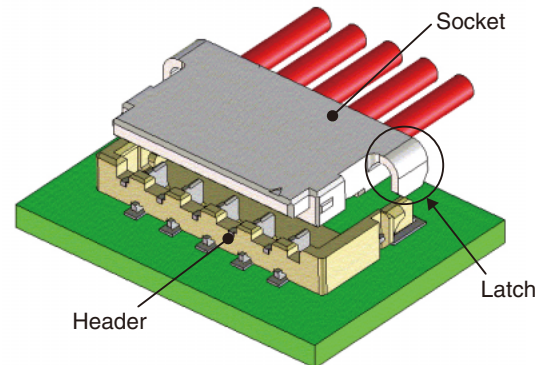

Latches are deflected slightly during mating.

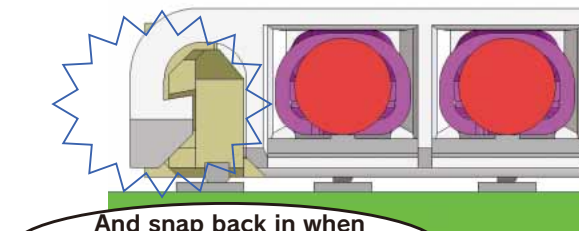
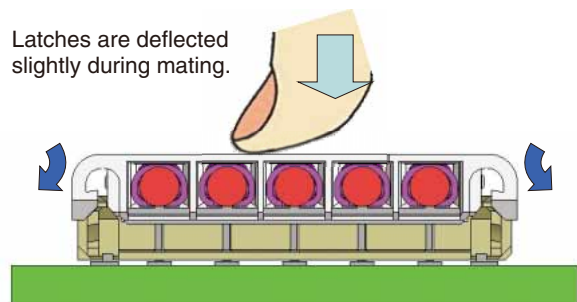

And snap back in when mating is complete.
A click feeling will be felt!

Fig.1

Vertical mating provides superior operability and maximizes board space.

Vertical mating type

Side view of the PCB

Vertical mating style allows other parts to be mounted.
(Enhances freedom in designing PCB)

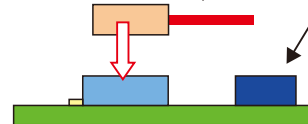

The mating face is easy to see, resulting in proper insertion.

Horizontal mating type

Unused, open area

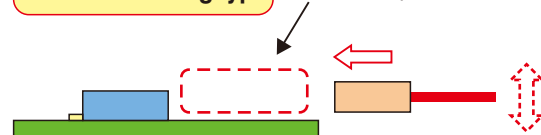

The mating face can be hard to see, which can lead to awkward insertion.

Fig.2

Product Specifications

Ratings	Current Rating	No. of Contacts	24 AWG	26 AWG	28 AWG	Operating Temperature Range	-40 to +105°C (注2)
		3	4A	2.5A	2.5A	Operating Humidity Range	20 to 80% (注3)
		4				Storage Temperature Range	-10 to +60°C (注4)
		5	3.5A	2A	2A	Storage Humidity Range	40 to 70% (注4)
	6	UL/C-UL/File No. and Recognition No.					
7	AC/DC 50V			UL : E52653	C-UL : E52653		
Voltage Rating	Specification						

Item	Specifications	Conditions
1. Insulation resistance	100MΩ min.	Measured at DC 100V
2. Withstand voltage	No flashover or breakdown	AC 500V is applied for one minute.
3. Contact resistance	10mΩ max.	Measured at 1mA and no higher than 20mV
4. Vibration Resistance	No electrical discontinuity for more than 1μs	10 cycles in each of three directions at frequency 10-55 Hz, half amplitude 0.75mm
5. Shock Resistance	No electrical discontinuity for more than 1μs	Accelerated velocity : 490m/s ² , for 11 ms, half-sine in 3 directions, 3 times for each of the three directions
6. Moisture-resistance	Contact resistance : 20mΩ max. Insulation resistance : 500MΩ min.	Temperature : 40 ±2°C ; humidity : 90 to 95%, left as it is for 96 hours
7. Temperature cycles	Contact resistance : 20mΩ max. Insulation resistance : 500MΩ min.	-55°C : 30 minutes → 5 - 35°C : 2 - 3 minutes → 85°C : 30 minutes → 5 - 35°C : 2 - 3 minutes) 5 cycles
8. Durability	Contact resistance : 20mΩ max.	Tin plated : 30 mating cycles Gold plated : 50 mating cycles
9. Resistance to solder heat	The resin components will not become deformed or lose performance due to deformities	Reflow : according to the recommended temperature profile Hand soldering : temperature of soldering iron at 350°C±10°C for 3 seconds

Note 1 : This is the maximum current rating while all pins are powered or used as all power lines. If you split the current over multiple lines, please factor in your own safety margin. Please contact Hirose Electric, for inquiries on the assignment of pins and on the currents that can be delivered.

Note 2 : Includes the temperature rise of power lines.

Note 3 : Use without condensation on parts.

Note 4 : The storage condition refers to long-term storage of the product on the shelf before assembly. Please use the operating temperature for temporary storage such as pre-assembly and during shipping.

Materials / Finish

Product	Part	Materials	Finish	UL specification
Header	Insulator	LCP	Black	UL94V-0
	Contact	Brass	Tin Plated or Gold plated	-
Crimp socket	Insulator	LCP	Beige	UL94V-0
Crimp contact	Contact	Phosphorous Bronze	Tin Plated or Gold plated	-

Product Number Structure

Refer to the chart below when determining the product specifications from the product number.

Please select from the product numbers listed in this catalog when placing orders.

Header connector

DF 65 - * P - 1.7 V

① ② ③ ④ ⑤ ⑥

① Series Name : DF	⑥ Mounting style V : SMT Straight Type
② Series No. : 65	
③ Number of contacts : 3, 4, 5, 6, 7	
④ Connector type P:Header	
⑤ Pitch : 1.7mm	

Socket connector

DF 65 - * S - 1.7 C

① ② ③ ④ ⑤ ⑥

① Series Name : DF	⑤ Pitch : 1.7mm
② Series No. : 65	
③ Number of contacts: 3, 4, 5, 6, 7	⑥ Termination form C : crimp case
④ Connector type S : socket	

Crimp contact

DF 65 - 2428 SCF

① ②

① Applicable wire size 2428 : 24 to 28 AWG	② Packaging style SCF : Socket contact·Reel·Tin plated SCFA : Socket contact·Reel·Gold plated
---	---

Straight pin header

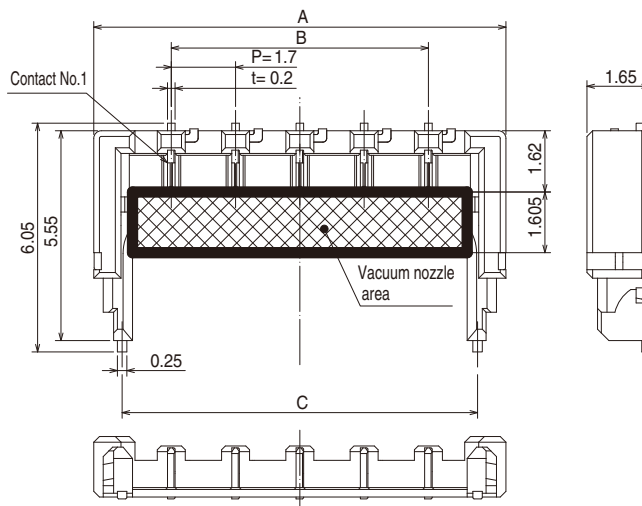

Recommended PCB layout (t=1mm)

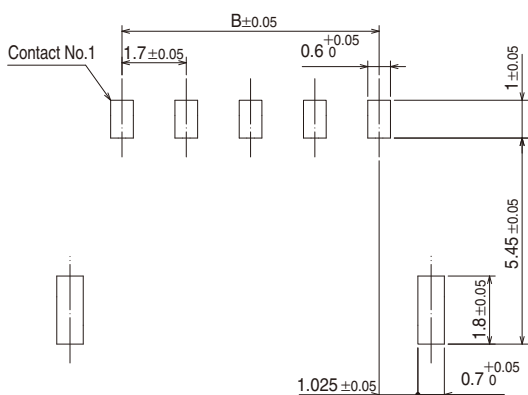

[Specification Number]**
 (21) : Tin plated, embossed packaging
 (78) : Gold plated, embossed packaging

Part No.	HRS No.	No. of Contacts	A	B	C
DF65-3P-1.7V (**)	666-6004-5 **	3	7.5	3.4	6
DF65-4P-1.7V (**)	666-6006-0 **	4	9.2	5.1	7.7
DF65-5P-1.7V (**)	666-6001-7 **	5	10.9	6.8	9.4
DF65-6P-1.7V (**)	666-6008-6 **	6	12.6	8.5	11.1
DF65-7P-1.7V (**)	666-6014-9 **	7	14.3	10.2	12.8

Note 1 : This product is sold per reel with 4,000 connectors pcs/reel. Please order by reel quantities.

Note 2 : Please contact Hirose representative if you have request for (78) specification.

Tape and Reel Dimensions

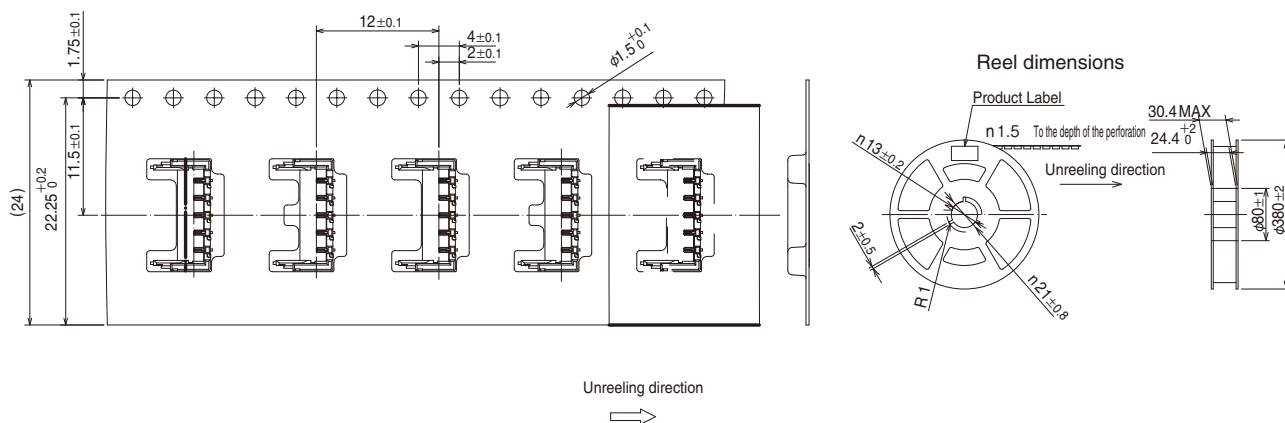

■ Crimp socket

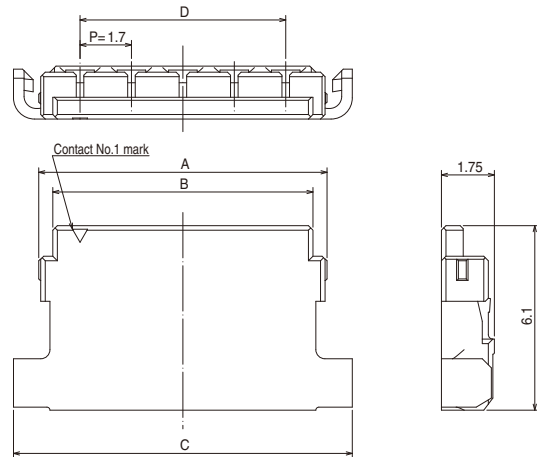

Part No.	HRS No.	No. of Contacts	A	B	C	D
DF65-3S-1.7C(**)	666-6005-8 **	3	6.13	5.2	7.8	3.4
DF65-4S-1.7C(**)	666-6007-3 **	4	7.83	6.9	9.5	5.1
DF65-5S-1.7C(**)	666-6002-0 **	5	9.53	8.6	11.2	6.8
DF65-6S-1.7C(**)	666-6009-9 **	6	11.23	10.3	12.9	8.5
DF65-7S-1.7C(**)	666-6015-1 **	7	12.93	12	14.6	10.2

[Specification Number]**
None : 1 package contains
100 pcs/pack

Note : Each package contains 100 pcs/pack. Please order in full package quantities.

◆ Crimp contact

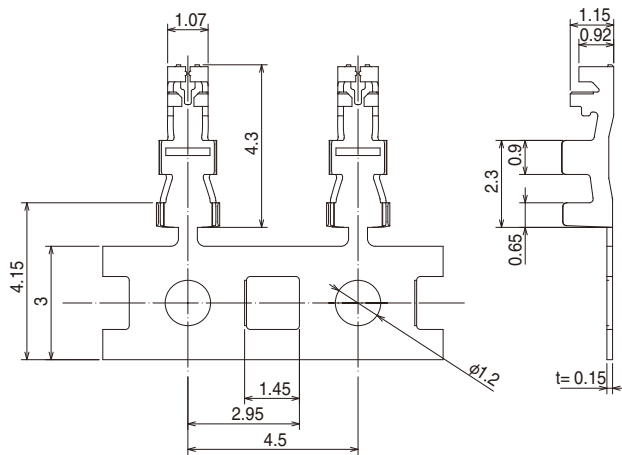

[Specification Number]**
None : 18,000 pcs/reel
(07) : 18,000 pcs/reel · Gold plated

Part No.	HRS No.	Description	Quantity	Finish	RoHS
DF65-2428SCF	666-0003-2 00	Reel contact	18,000 pcs/reel	Tin plated	○
DF65-2428SCFA(**)	666-6016-4 **	Reel contact	18,000 pcs/reel	Gold plated	○

Note : This product is sold per reel (18,000 pcs/reel), please order by reel quantities.

● Applicable wire (Tinned, annealed copper wire)

Conductor size (Core structure)	Jacket Diameter
24 AWG (11 pieces/φ 0.16 mm)	φ1.11mm
26 AWG (7 pieces/φ 0.16 mm)	φ0.98mm
28 AWG (7pieces/φ 0.127 mm)	φ0.88mm

● Recommended wire
UL10368

● Strip length
1.4 to 1.8mm

Note : Please contact your local Hirose sales rep if you plan on using wires other than those listed above.

◆ Tooling Information

Item	Part No.	HRS No.	Applicable contact
Applicator	AP105-DF65-2428S	901-4630-0 00	DF65-2428SCF, DF65-2428SCFA
Press body	CM-105C	901-0001-0 00	—
Hand tool	HT305/DF65-2428S (Note3)	550-0306-8 00	DF65-2428SCF, DF65-2428SCFA
Extraction tool	DF-C-PO (B)	550-0179-2 00	DF65-2428SCF

Note 1 : Hirose does not cover damage created by the use of unapproved Hirose Tools. Please contact your local Hirose Sales for clarification.

Note 2 : Please conduct crimping work according to the "Crimping work standards" and "Crimping condition table".

Note 3 : The compatible wire is limited to UL10368, 24 to 28 AWG.

◆ Precautionary notes

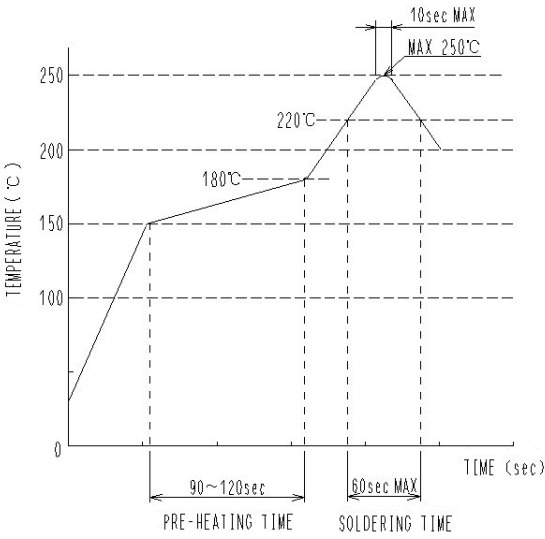
<p>1. Recommended Soldering Profile (Compatible with lead-free soldering)</p>	 <p>[Applicable Conditions]</p> <ol style="list-style-type: none"> 1. Peak temperature : MAX 250°C 2. Heating Area: 220°C or above, within 60sec . 3. Preheating Area: 150~180°C , 90~120 sec. <p>* Measurement is conducted at the contact lead part Please check the mounting conditions before use, conditions such as solder paste types, manufacturer, PCB size and any other soldering materials may alter the performance of such materials. (Note 1) This temperature profile is a recommended value only; please contact your Hirose Sales Rep for more information</p>
<p>2. Recommended hand soldering conditions</p>	<p>Temperature of soldering iron: 350±10°C, soldering time: no more than 3 seconds</p>
<p>3. Recommended screen thickness, aperture ratio (pattern surface ratio)</p>	<p>Thickness: 0.1mm, aperture opening ratio: 100%</p>
<p>4. Warping of PC Board</p>	<p>A maximum of 0.02mm at the center of connector, as measured from either end of the connector</p>
<p>5. Cleaning Conditions</p>	<p>IPA cleaning is allowed. (Cleaning is not recommended because cleaning may change the push/pull feeling etc. Please contact your local Hirose representative prior to the use of any cleaning agents.)</p>
<p>6. Precautions</p>	<ul style="list-style-type: none"> ■ When inserting the crimp contact into the crimp socket, do not insert it at a slanted angle to maintain the reliability of its performance. ■ Please use caution when mating/unmating this connector if it has not been mounted onto the PCB, doing so could deform or damage the contacts. ■ Do not pull on the wires of this connector as this may cause damage to the connector. ■ During the hand soldering process, make sure to not apply too much flux. Doing so may cause a solder wicking problem. ■ This product may experience some differences in color from one production lot to another. This color difference does not influence the performance of the connector. ■ For handling precautions to be used during the insertion/removal process, please refer to the "DF65 Push-pull procedure".

7. Mating and Unmating Operation

Mating operation

① Align the receptacle over the header

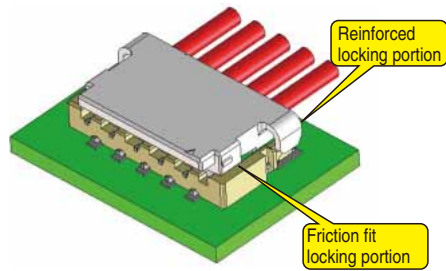

② Insert and press down on the receptacle in the direction of the arrow.

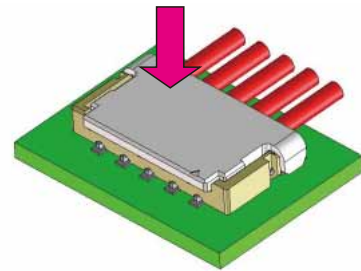

③ Completed mating operation

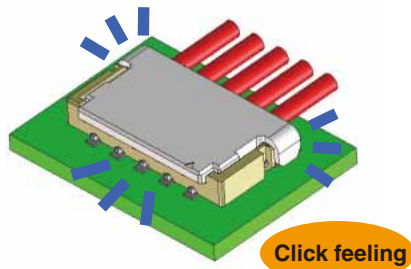

Unmating operation

① Start by lifting up on the front edge of the receptacle.

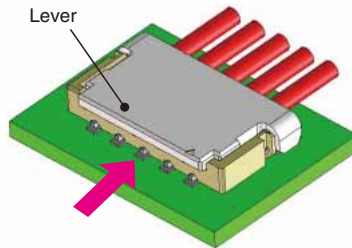

② Pull it upward to release the friction fit lock portion.

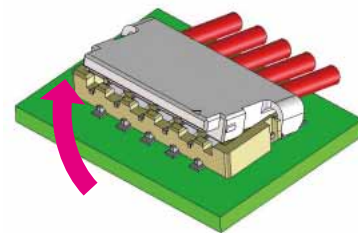

③ Reinforced lock portion will then be released. Continue lifting the receptacle in an upward direction.

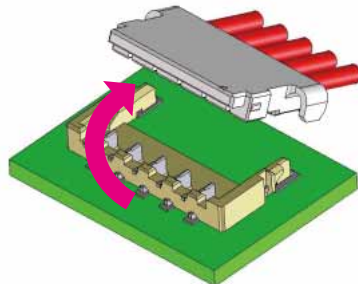

HIROSE ELECTRIC CO.,LTD.

2-6-3,Nakagawa Chuoh,Tsuzuki-Ku,Yokohama-Shi 224-8540,JAPAN
 TEL: +81-45-620-3526 Fax: +81-45-591-3726
<http://www.hirose.com>
<http://www.hirose-connectors.com>