

High-performance video signal Switcher Series

Video Drivers with Built-in**Low Voltage operation Single Video Switchers**

High-performance System video Driver Series

Video Drivers with Built-in**Input Selection SW**

BH76330FVM, BH76331FVM, BH76360FV, BH76361FV

High-performance video signal Switcher Series

Wide Band**Low Voltage operation Single Video Switchers**

BH76332FVM, BH76333FVM, BH76362FV, BH76363FV

No.09065EAT01

INDEX

Video Drivers with Built-in**Low Voltage operation Single Video Switchers**

BH76330FVM (3input 1output Video Switch) P2

BH76331FVM (3input 1output Video Switch) P2

BH76360FV (6input 1output Video Switch) P17

BH76361FV (6input 1output Video Switch) P17

Wide Band**Low Voltage operation Single Video Switchers**

BH76332FVM (3input 1output Video Switch) P2

BH76333FVM (3input 1output Video Switch) P2

BH76362FV (6input 1output Video Switch) P17

BH76363FV (6input 1output Video Switch) P17

Line-up of products with built-in video amplifier and video driver

3-input, 1-output video switch

BH76330FVM, BH76331FVM, BH76332FVM, BH76333FVM

● General

BH76330FVM, BH76331FVM, BH76332FVM, and BH76333FVM are video signal switching ICs, each with three inputs and one circuit input, which feature wide dynamic range and frequency response. Since these ICs can be used with low voltage starting at VCC = 2.8 V, they are applicable not only in stationary devices but also in mobile devices.

This product line-up supports a broad range of input signals, depending on whether or not a 6-dB video amplifier and video driver are included and what combination of sync tip clamp type and bias (resistor termination) type inputs are used.

● Features

- 1) Able to use a wide range of power supply voltage, from 2.8 V to 5.5 V
- 2) Wide output dynamic range
- 3) Excellent frequency response
(BH76330FVM and BH76331FVM: 100 kHz/10 MHz 0 dB [Typ.], BH76332FVM and BH76333FVM: 100 kHz/30 MHz 0 dB [Typ.])
- 4) No crosstalk between channels (Typ. -65 dB, f = 4.43 MHz)
- 5) Built-in standby function, circuit current during standby is 0 μA (Typ.)
- 6) Sync tip clamp input (BH76330FVM, BH76332FVM)
- 7) Bias input (Zin = 150 kΩ) (BH76331FVM, BH76333FVM)
- 8) 6-dB amp and 75Ω driver are built in (BH76330FVM, BH76331FVM)
- 9) Enables two load drivers [when using output coupling capacitor] (BH76330FVM, BH76331FVM)
- 10) Able to be used without output coupling capacitor (BH76330FVM)
- 11) MSOP8 compact package

● Applications

Input switching in car navigation systems, TVs, DVD systems, etc.

● Line-up

	BH76330FVM	BH76331FVM	BH76332FVM	BH76333FVM
Supply voltage	2.8 V to 5.5 V			
Amp gain	6 dB		-0.1 dB	
Video driver	Included		-	
Frequency response	100 kHz/10 MHz, 0 dB (Typ.)		100 kHz/30 MHz, 0 dB (Typ.)	
Input type	Sync tip clamp	Bias (Zin = 150 kΩ)	Sync tip clamp	Bias (Zin = 150 kΩ)

● Absolute maximum ratings (Ta = 25°C)

Parameter	Symbol	Limits	Unit
Supply voltage	VCC	7.0	V
Power dissipation	Pd	470 *1	mW
Input voltage range	VIN	0 to VCC+0.2	V
Operating temperature range	Topr	-40 to +85	°C
Storage temperature range	Tstg	-55 to +125	°C

*1 When used while Ta = 25°C, 4.7 mW is dissipated per 1°C
Mounted on 70 mm x 70 mm x 1.6 mm glass epoxy board

● Operation range (Ta = 25°C)

Parameter	Symbol	Min.	Typ.	Max	Unit
Supply voltage	VCC	2.8	5.0	5.5	V

● Electrical characteristics 1 (unless otherwise specified, Ta = 25°C, VCC = 5 V)

Parameter	Symbol	Typ.				Unit	Conditions
		76330	76331	76332	76333		
Circuit current 1	ICC1	10		9		mA	When no signal
Circuit current 2	ICC2	0.0				μA	During standby
Circuit current 3	ICC3-1	11		10		mA	During output of color bar signal
	ICC3-2	17	—				During output of color bar signal (no C in output)
Maximum output level	VOM	4.6		3.8	3.4	Vpp	f = 10 kHz, THD = 1%
Voltage gain	Gv	6.0		-0.1		dB	Vin = 1.0 Vpp, f = 100 kHz
Frequency response	GF1	0		—		dB	Vin = 1.0 Vpp, f = 10 MHz/100 kHz
	GF2	—		0		dB	Vin = 1.0 Vpp, f = 30 MHz/100 kHz
Crosstalk between channels	CT	-65				dB	Vin = 1.0 Vpp, f = 4.43 MHz
Mute attenuation	MT	-65				dB	Vin = 1.0 Vpp, f = 4.43 MHz
CTL pin switch level	VTHH	1.2 Min				V	High level threshold voltage
	VTHL	0.45 Max				V	Low level threshold voltage
CTL pin inflow current	ITHH	50 Max				μA	CTL pin = 2.0 V applied
Input impedance	Zin	—	150	—	150	kΩ	
Differential gain	DG	0.3				%	Vin = 1.0 Vpp
Differential phase	Dp-1	0.7		0.3		deg.	Standard stair step signal
	Dp-2	0.0	—				Same condition as above (no C in output)
Y-related S/N	SNY	+75		+78		dB	Vin = 1.0 Vpp, bandwidth: 100 k to 6 MHz 100% white video signal
C-related S/N [AM]	SNCA	+75				dB	Vin = 1.0 Vpp, bandwidth: 100 to 500 kHz
C-related S/N [PM]	SNCP	+65					100% chroma voltage signal

● Electrical characteristics 2 (unless otherwise specified, Ta = 25°C, VCC = 3 V)

Parameter	Symbol	Typ.				Unit	Conditions
		76330	76331	76332	76333		
Circuit current 1	ICC1	8.5		8.0		mA	When no signal
Circuit current 2	ICC2	0.0				μA	During standby
Circuit current 3	ICC3-1	9.5		9.0		mA	During output of color bar signal
	ICC3-2	15.5	—				During output of color bar signal (no C in output)
Maximum output level	VOM	2.7	2.8	1.8	1.9	Vpp	f = 10 kHz, THD = 1%
Voltage gain	Gv	6.0		-0.1		dB	Vin = 1.0 Vpp, f = 100 kHz
Frequency response	GF1	0		—		dB	Vin = 1.0 Vpp, f = 10 MHz/100 kHz
	GF2	—		0		dB	Vin = 1.0 Vpp, f = 30 MHz/100 kHz
Crosstalk between channels	CT	-65				dB	Vin = 1.0 Vpp, f = 4.43 MHz
Mute attenuation	MT	-65				dB	Vin = 1.0 Vpp, f = 4.43 MHz
CTL pin switch level	VTHH	1.2 Min				V	High level threshold voltage
	VTHL	0.45 Max				V	Low level threshold voltage
CTL pin inflow current	ITHH	50 Max				μA	CTL pin = 2.0 V applied
Input impedance	Zin	—	150	—	150	kΩ	
Differential gain	DG	0.3	0.7	0.3		%	Vin = 1.0 Vpp
Differential phase	Dp-1	1.0		0.3		deg.	Standard stair step signal
	Dp-2	0.5	—				Same condition as above (no C in output)
Y-related S/N	SNY	+75		+78		dB	Vin = 1.0 Vpp, bandwidth: 100 k to 6 MHz 100% white video signal
C-related S/N [AM]	SNCA	+75				dB	Vin = 1.0 Vpp, bandwidth: 100 to 500 kHz
C-related S/N [PM]	SNCP	+65					100% chroma video signal

(Note) Re: ICC3, VOM, Gv, GF, CT, MT, DG, Dp, SNY, SNCA, and SNCP parameters

BH76330FVM and BH76331FVM: RL = 150 Ω

BH76332FVM and BH76333FVM: RL = 10 kΩ

● Control pin settings

	CTL	
	A	B
STBY	L(OPEN)	L(OPEN)
IN1	L(OPEN)	H
IN2	H	L(OPEN)
IN3	H	H

● Block diagram

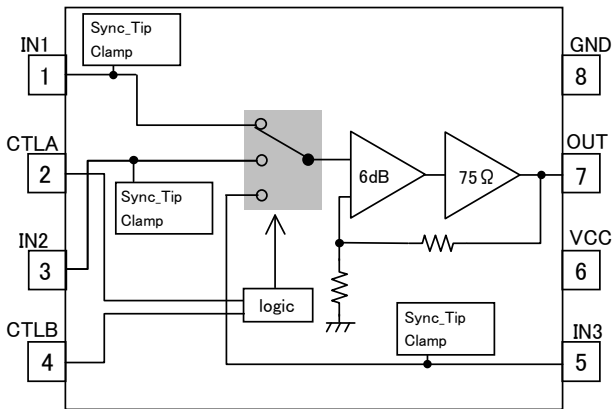

Fig.1 BH76330FV

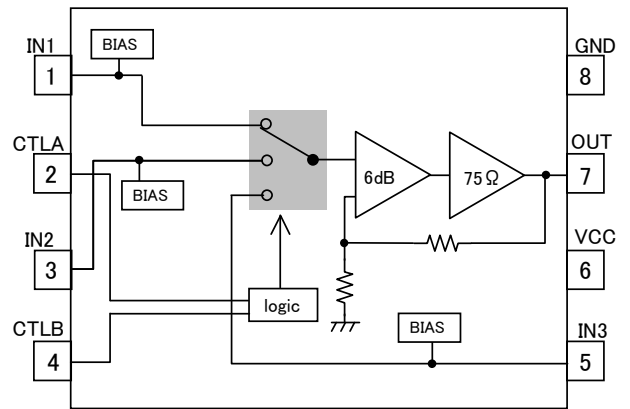

Fig.2 BH76331FV

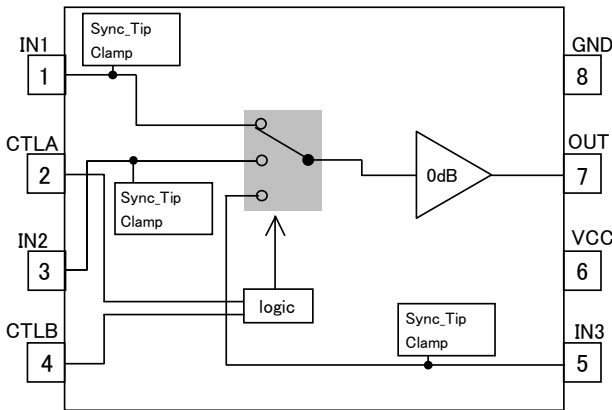

Fig.3 BH76332FV

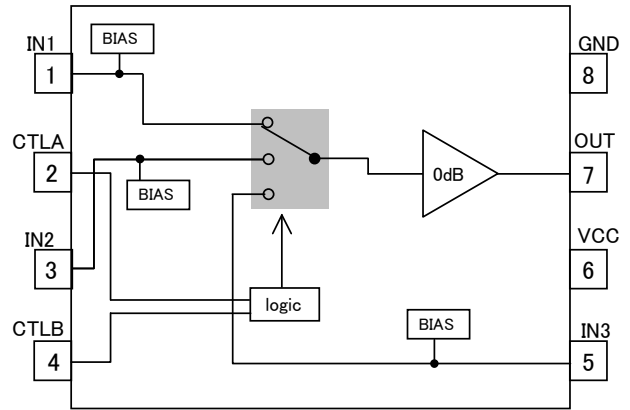

Fig.4 BH76333FV

● I/O equivalent circuit diagrams

Input pins

Sync tip clamp input BH76330FVM/BH76332FVM			Bias input BH76331FVM/BH76333FVM		
Pin No.	Name	Equivalent circuit	Pin No.	Name	Equivalent circuit
1 3 5	IN1 IN2 IN3		1 3 5	IN1 IN2 IN3	
Video signal input pin is used for sync tip clamp input. • DC potential BH76330FVM: 1.5 V BH76332FVM: 1.0 V			Video signal input pin is used for bias type input. Input impedance is 150 kΩ. • DC potential BH76331FVM: 3.1 V BH76333FVM: 2.5 V		

Control pins

Pin No.	Name	Equivalent circuit
2 4	CTLA CTLB	
Switches operation mode [active or standby] and input pin. Threshold level is 0.45 V to 1.2 V.		

Output pin

With video driver BH76330FVM/BH76331FVM			Without video driver BH76332FVM/BH76333FVM		
Pin No.	Name	Equivalent circuit	Pin No.	Name	Equivalent circuit
7	OUT		7	OUT	
Video signal output pin. Able to drive loads up to 75 Ω (dual drive). • DC potential BH76330FVM: 0.16 V BH76331FVM: 2.5 V			Video signal output pin. • DC potential BH76332FVM: 0.3 V BH76333FVM: 1.8 V		

Note 1) The above DC potential is only when VCC = 5 V. This value is a reference value and is not guaranteed.

Note 2) Numerical values shown in these figures are design values, and compliance to standards is not guaranteed.

● Test Circuit Diagrams

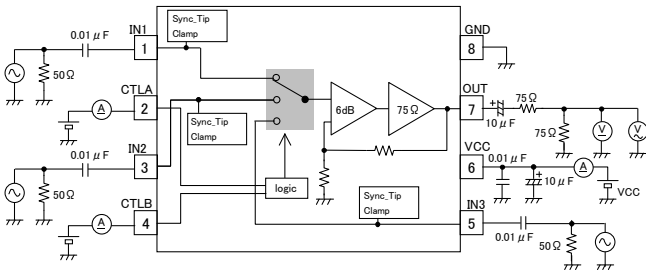

Fig. 5 BH76330FV/BH76331FV Test Circuit Diagram

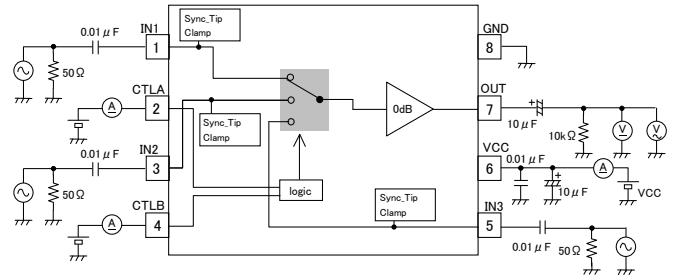

Fig. 6 BH76332FV/BH76333FV Test Circuit Diagram

Test circuit diagrams are used for shipment inspections, and differ from application circuits.

● Application circuit examples

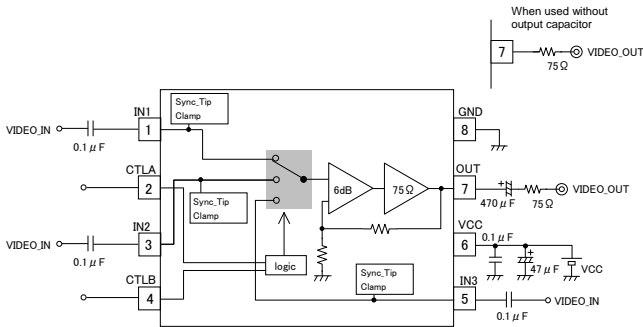

Fig. 7 BH76330FV

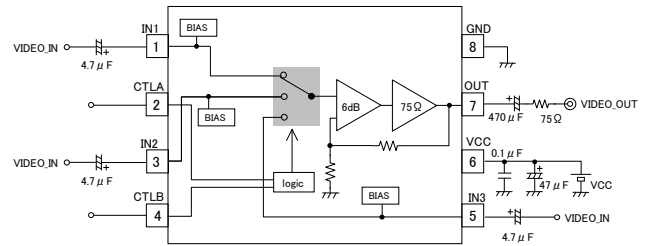

Fig. 8 BH76331FV

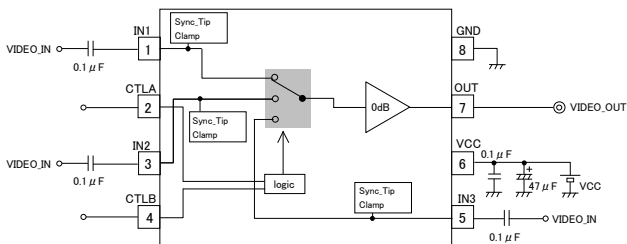

Fig. 9 BH76332FV

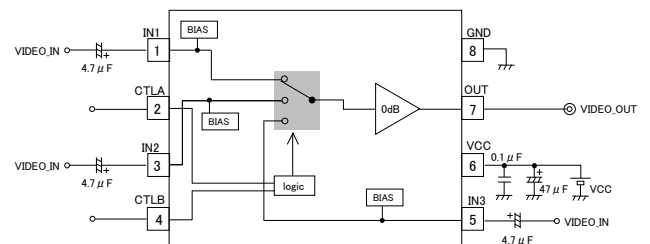

Fig. 10 BH76333FV

See pages 6/16 to 10/16 for description of how to determine the capacity of I/O coupling capacitors.

● Cautions for selection and use of application parts

When using this IC by itself ①

Input type	Input impedance Z _{in}	Capacity of input coupling capacitor (recommended value)	Capacity of output coupling capacitor (recommended value)
Sync_Tip_Clamp	10 MΩ	0.1 μF	470 μF to 1000 μF
Bias	150 kΩ	4.7 μF	

Method for determining capacity of input coupling capacitor

The HPF is comprised of an input coupling capacitor and the internal input impedance Z_{in} of the IC. Since the fc value of this HPF is determined using the following equation (a), the above recommended capacity for the input capacitor is derived. Usually, the cutoff frequency fc is several Hz.

$$f_c = 1 / (2\pi \times C \times Z_{in}) \dots (a)$$

When evaluating the sag characteristics and determining the capacity of the capacitor during video signal input, a horizontal stripe signal called "H bar" (shown in Fig. 10) is suitable, and this type of signal is used instead of a color bar signal to evaluate characteristics and determine capacity.



Fig.11 Example of Screen with Obvious Sag (H-bar Signal)

Method for determining capacity of output coupling capacitor

The output pins of models with a 75Ω driver [BH76330FVM and BH76331FVM] have an HPF comprised of an output coupling capacitor and load resistance R_L (= 150Ω). When fc is set to approximately 1 Hz or 2 Hz, the capacity of the output coupling capacitor needs to be approximately 470 μF to 1000 μF.

As for models without the 75Ω driver, an HPF is similarly comprised using the capacity of the output coupling capacitor and the input impedance of the IC connected at the next stage, and the capacitance required for the output coupling capacitor should be estimated using equation (a).

When this IC is used as a standalone device ②

In models that include a 75Ω driver [BH76330FVM and BH76331FVM], up to two monitors (loads) can be connected (a connection example is shown in Fig. 12). When there are multiple loads, the number of output coupling capacitors must be increased or a larger capacitance must be used, based on the table shown below.

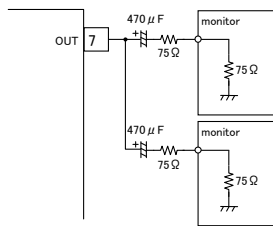

Fig. 12 (a) Application Circuit Example 1 (Two Drives)

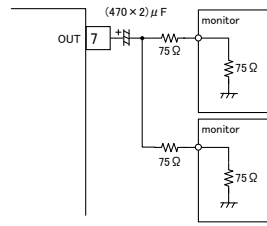

Fig. 12 (b) Application Circuit Example 2 (Two Drives)

Application circuit example	No. of output capacitors	Capacitance per output capacitor (recommended values)
Fig. 12 (a)	No. of drives required	470 μF to 1000 μF (same as with one drive)
Fig. 12 (b)	1	(No. of drive × 470 μF to 1000) uF

When this IC is used as a standalone device ③

The BH76330FVM is the only model that can be used without an output coupling capacitor.

This use method not only enables reductions in board space and part-related costs, but it is able to improve the sag characteristics by improving low-range frequency response. However, when the output coupling capacitor is omitted, a direct current flows to the connected set, so the specifications of the connected set should be noted carefully before starting use.

Note also that only one load can be connected when the output coupling capacitor is omitted.

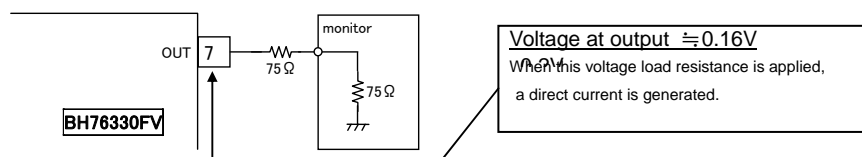

Fig.13 Application Example without Output Coupling Capacitor

When using several of these ICs ①

When several of these ICs are used, it enables applications in which separate images are output to the car navigation system's front and rear monitors.

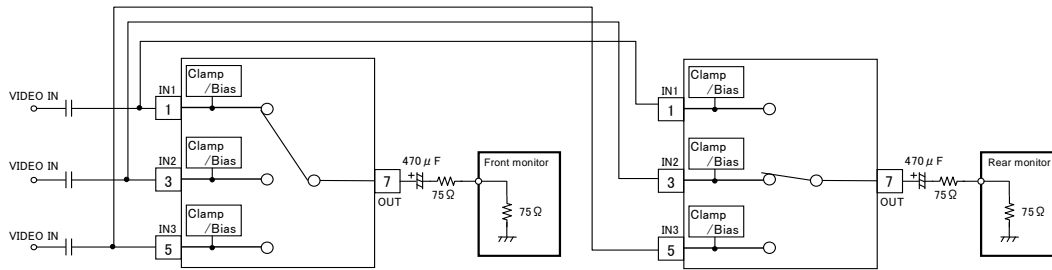

Fig.14 Application Example when Using Several ICs

When several ICs are used at the same time, the number of parallel connections of input impedance equals the number of ICs being used, which reduces the input impedance. This also raises the f_c value of the HPF formed at the input pin block, so the capacitance of the input coupling capacitor must be increased according to equation (a). The recommended values for calculation results are listed in the table below.

When a clamp is used as the input type, the original input impedance becomes much greater, and if two or three are used at the same time there is no need to change the capacitance of the input coupling capacitor.

Input type	Input impedance per IC	Number of ICs used	Total input impedance	Capacitance of input coupling capacitor (recommended values)
Sync_Tip_Clamp	Approx. 10 MΩ	2	Approx. 5 MΩ	0.1 μF
		3	Approx. 3 MΩ	0.1 μF
Bias	150 kΩ	2	75 kΩ	6.8 μF~
		3	50 kΩ	10 μF~

When using several of these ICs ②

When three bias input type models (BH76331FVM or BH76333FVM) are used in parallel, they can be used for RGB signal switching applications. Likewise, when one clamp input type model (BH76330FVM or BH76332FVM) is connected in parallel with two bias input type models (a total of three ICs used in parallel), they can be used for component signal switching applications. The same method can be used to determine the capacitance of I/O coupling capacitors of these applications.

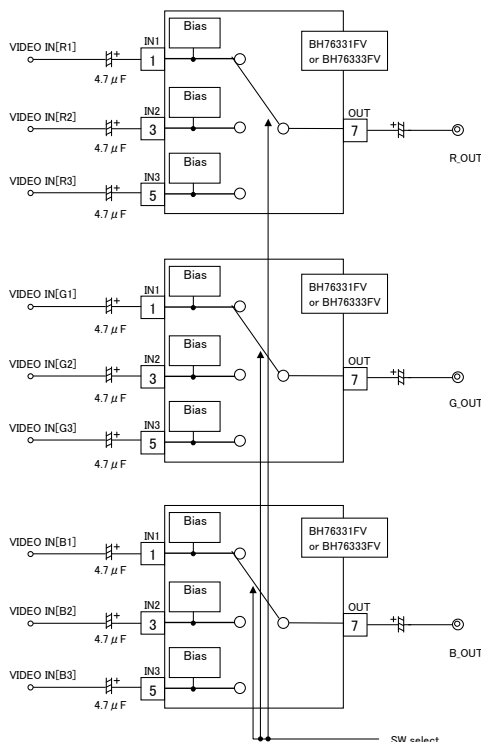

Fig. 15 (a). RGB Signal Switching Application Example (using three bias input type models in parallel)

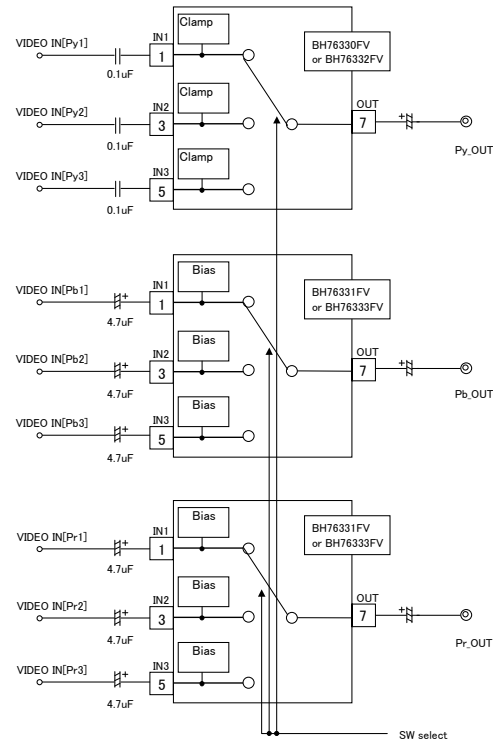

Fig. 15 (b). Component Signal Switching Application Example (using one clamp input type model and two bias input type models in parallel)

● Cautions for use

1. The numerical values and data shown here are typical design values, not guaranteed values.
2. The application circuit examples show recommended circuits, but characteristics should be checked carefully before using these circuits. If any external part constants are modified before use, factors such as variation in all external parts and ROHM LSI ICs, including not only static characteristics but also transient characteristics, should be fully considered to set an ample margin.
3. Absolute maximum ratings
If the absolute maximum ratings for applied voltage and/or operation temperature are exceeded, LSI damage may result. Therefore, do not apply voltage or use in a temperature that exceeds these absolute maximum ratings. If it is possible that absolute maximum ratings will be exceeded, use a physical safety device such as a fuse and make sure that no conditions that might exceed the absolute maximum ratings will be applied to the LSI IC.
4. GND potential
Regardless of the operation mode, the voltage of the GND pin should be at least the minimum voltage. Actually check whether or not the voltage at each pin, including transient phenomena, is less than the GND pin voltage.
5. Thermal design
The thermal design should be done using an ample margin that takes into consideration the allowable dissipation under actual use conditions.
6. Shorts between pins and mounting errors
When mounting LSI ICs onto the circuit board, make sure each LSI's orientation and position is correct. The ICs may become damaged if they are not mounted correctly when the power is turned on. Similarly, damage may also result if a short occurs, such as when a foreign object is positioned between pins in an IC, or between a pin and a power supply or GND connection.
7. Operation in strong electromagnetic field
When used within a strong electromagnetic field, evaluate carefully to avoid the risk of operation faults.
8. Place the power supply's decoupling capacitor as close as possible to the VCC pin (PIN 6) and GND pin (PIN 8).
9. With a clamp input type model (BH76330FVM or BH76332FVM), if any unused input pins are left open they will oscillate, so unused input pins should instead be connected to GND via a capacitor or else directly connected to VCC.
10. With models that do not include a 75Ω driver (BH76332FVM or BH76333FVM), in some cases the capacitance added to the set board may cause the peak frequency response to occur at a high frequency. To lower the peak frequency, connect in series resistors having resistance of several dozen Ω to several hundred Ω as close as possible to the output pin.

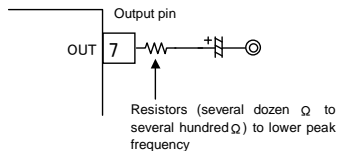

Fig.16 Positions where Resistors are Inserted to Lower Peak Frequency Response in BH76332FV or BH76333FV

11. Frequency response in models that do not include a 75-Ω driver (BH76332FVM and BH76333FVM) was measured as 100 kHz/30 MHz: 0 dB (Typ.) in the application circuit examples (shown in Fig. 9 and Fig. 10), and when resistance of about 1 or 2 kΩ is applied from the IC's output pin to GND, this frequency response can be improved (the lower limit of the applied resistance should be 1 kΩ). In such cases, gain is reduced, since the output voltage is divided by the added resistance and the output resistance of the IC.

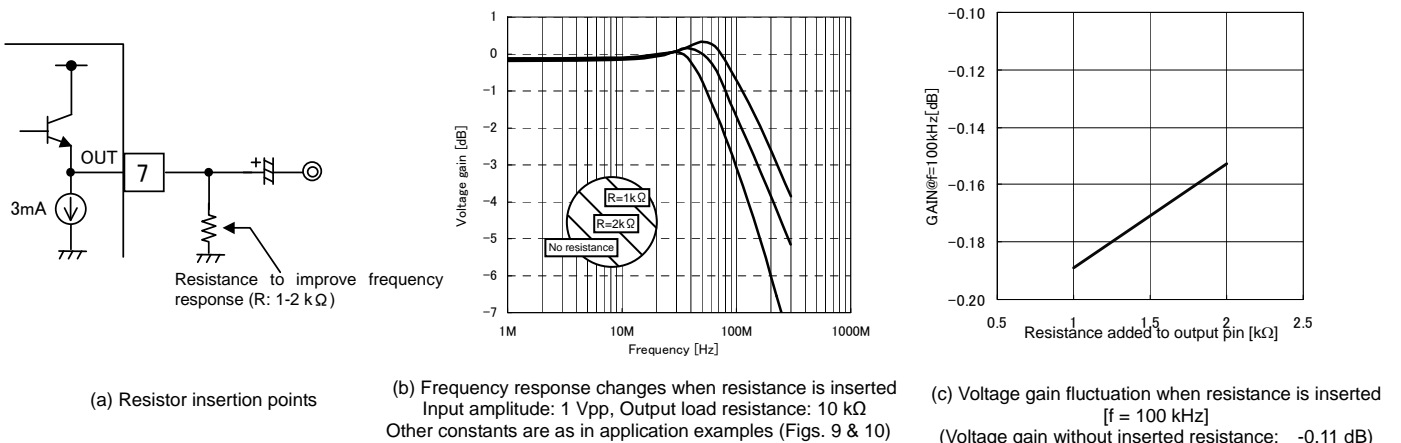

Fig.17 Result of Resistance Inserted to Improve BH76332FVM/BH76333FVM Frequency Response

12. With clamp input type models (BH76330FVM and BH76332FVM), if the termination impedance of the video input pin becomes higher, sync contractions or oscillation-related problems may occur. Evaluate temperature and other characteristics carefully and use at 1 kΩ or less.

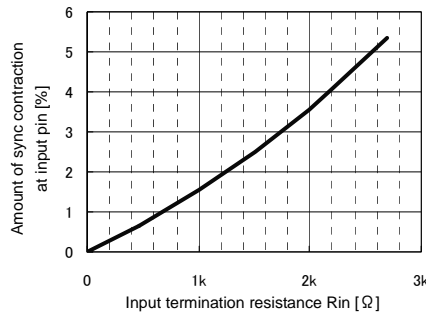

Fig. 18. Relation between Input Pin Termination Impedance and Amount of Sync Contraction

● Evaluation board pattern diagram and circuit diagram

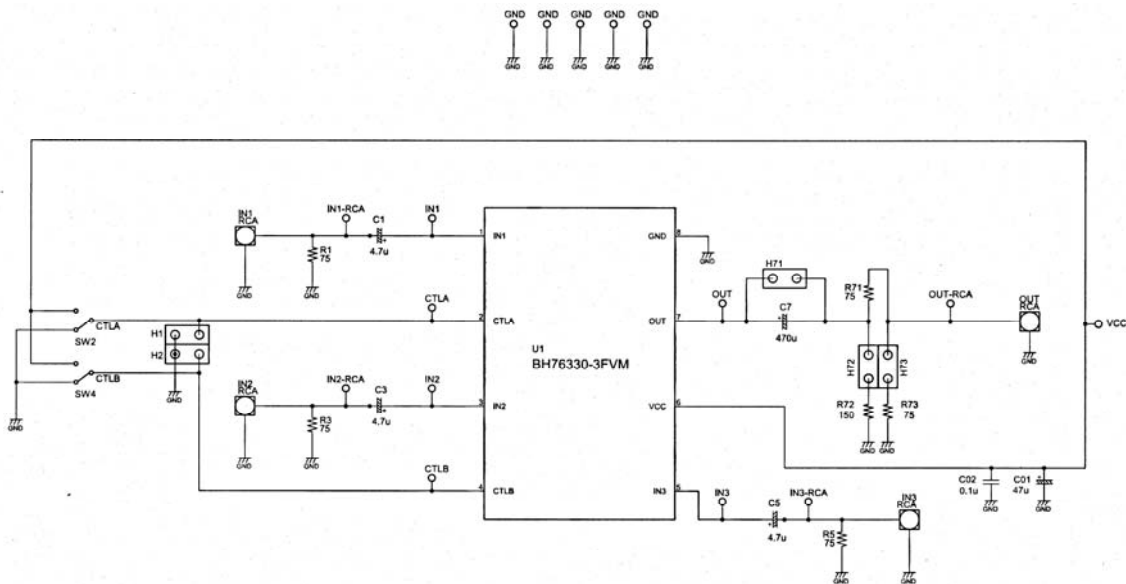

Fig. 19. Evaluation Board Circuit Diagram

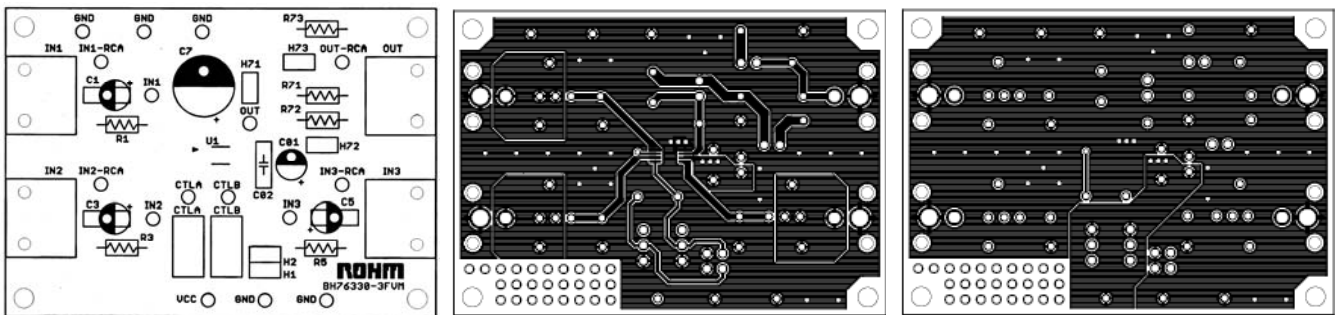
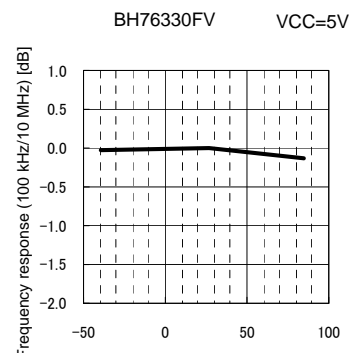
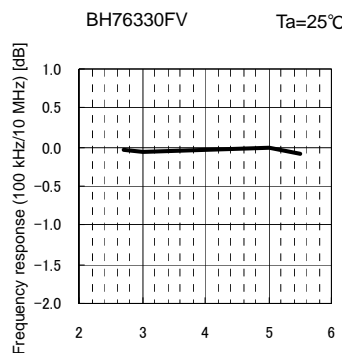
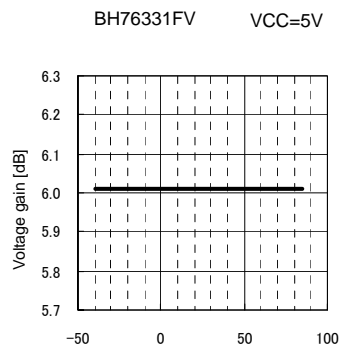
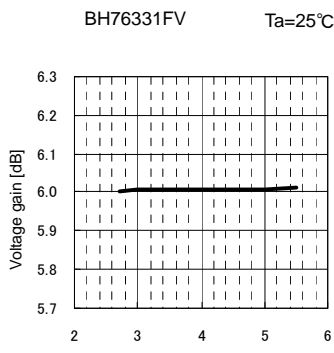
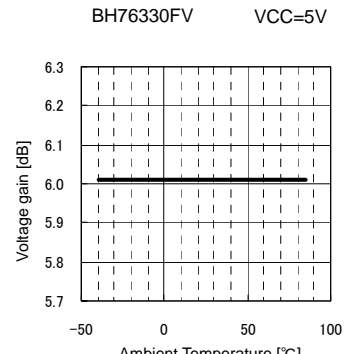
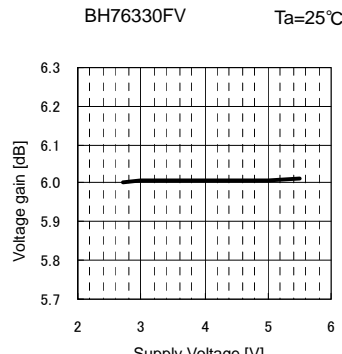
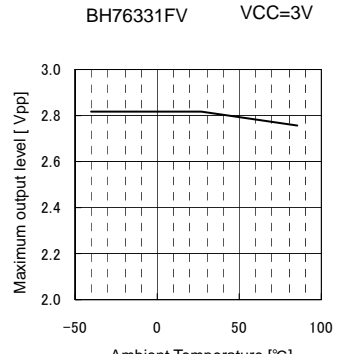
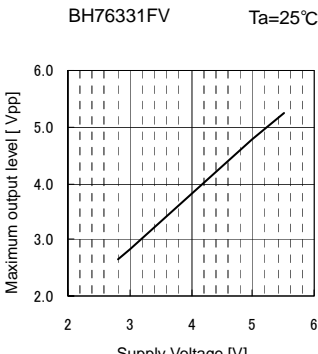
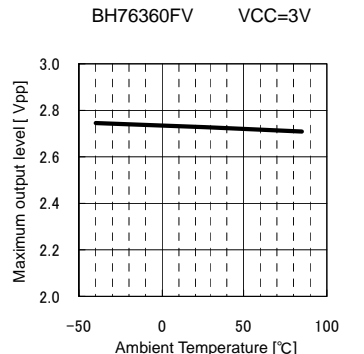
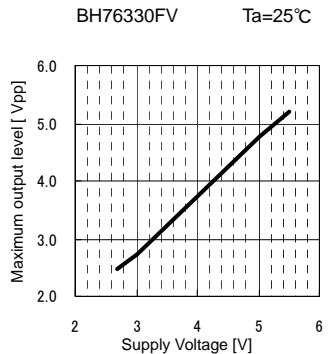
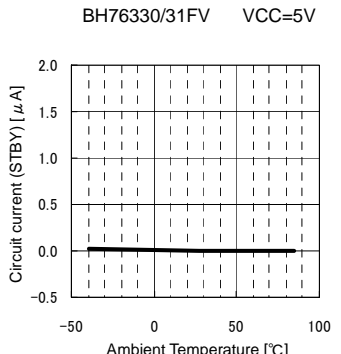
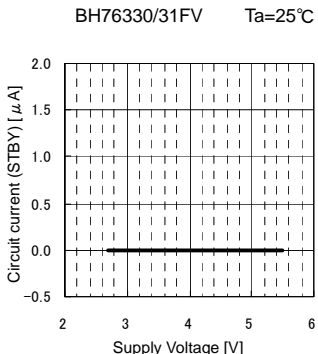
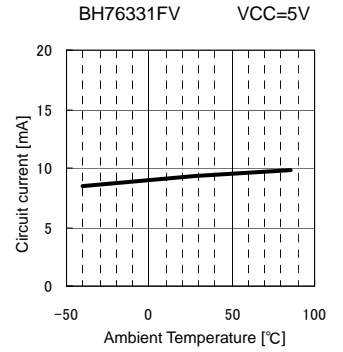
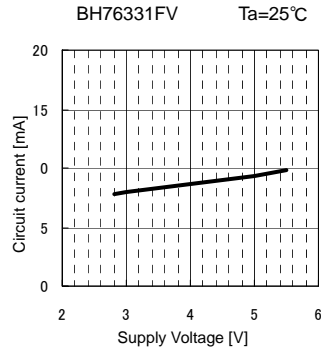
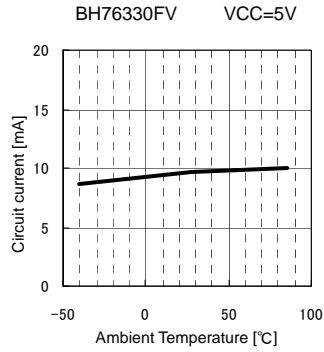
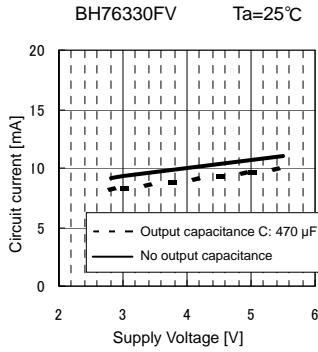

Fig. 20. Evaluation Board Pattern Diagram

Parts list

Symbol	Function	Recommended value	Comments
R1 R3 R5	Input terminating resistor	75 Ω	—
C1 C3 C5	Input coupling capacitor	See pages 6/16 to 7/16 to determine	B characteristics recommended
R71	Output resistor	75 Ω	—
C7	Output coupling capacitor	See pages 6/16 to 7/16 to determine	B characteristics recommended
C01	Decoupling capacitor	10 μF	B characteristics recommended
C02		0.1 μF	

● Reference data (1) BH76330FVM/BH76331FVM [unless otherwise specified, output capacitance C: 470 μ F, $R_L = 150 \Omega$]



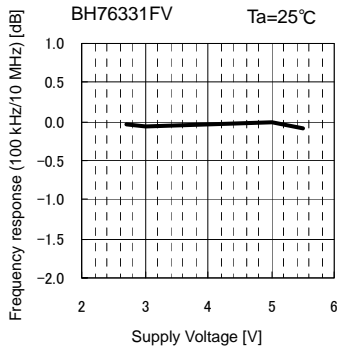

Fig.37 G_F vs. Supply Voltage

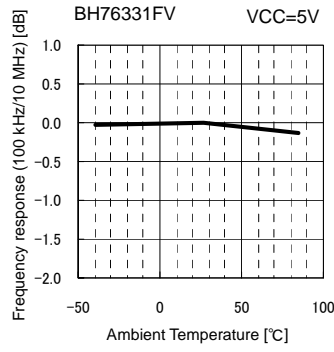

Fig.38 G_F vs. Ambient Temperature

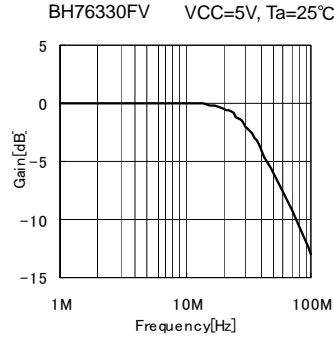

Fig.39 Frequency Response

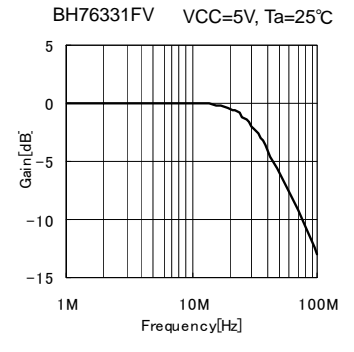

Fig.40 Frequency Response

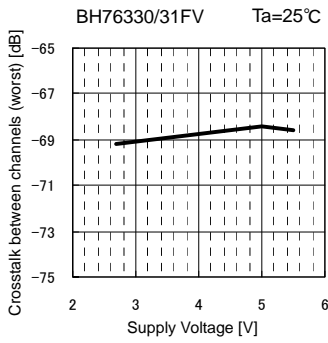

Fig.41 CT(worst) vs. Supply Voltage

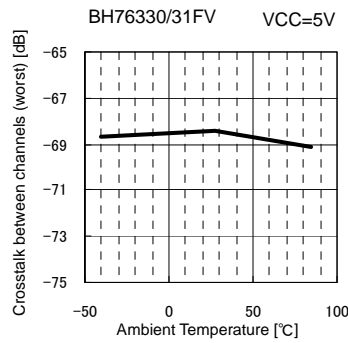

Fig.42 CT(worst) vs. Ambient Temperature

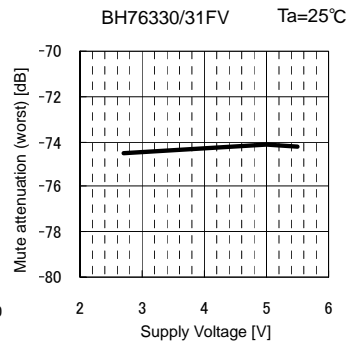

Fig.43 MT(worst) vs. Supply Voltage

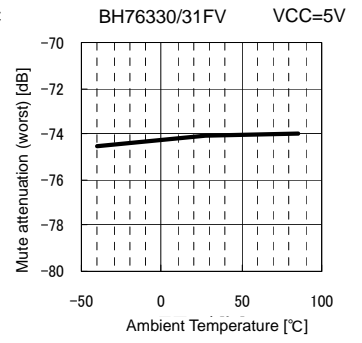

Fig.44 MT(worst) vs. Ambient Temperature

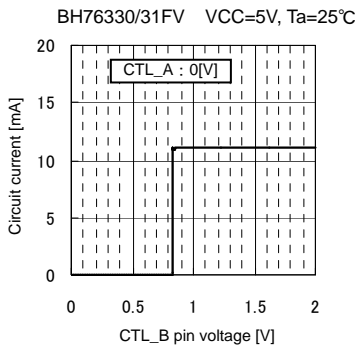

Fig.45 CTLb pin voltage vs Circuit Current (CLT threshold)

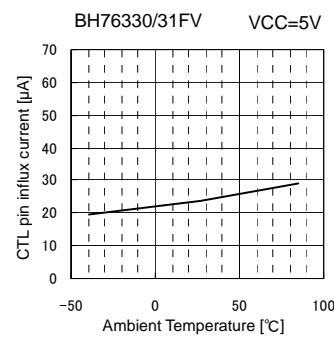

Fig.46 I_{THH} vs. Ambient Temperature (Voltage applied to CTL pin = 2V)

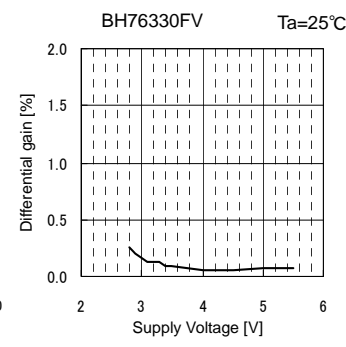

Fig.47 DG vs. Supply Voltage

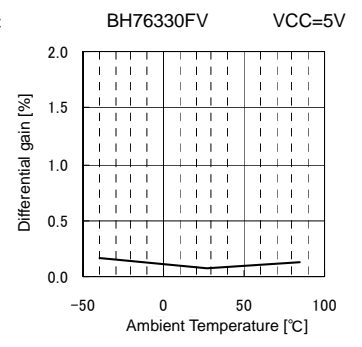

Fig.48 DG vs. Ambient Temperature

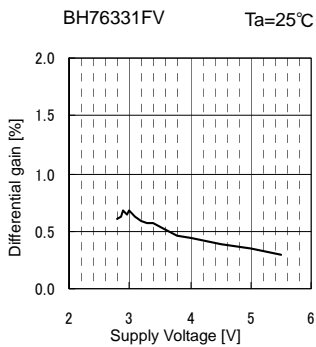

Fig.49 DG vs. Supply Voltage

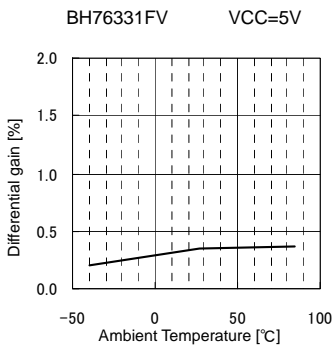

Fig.50 DG vs. Ambient Temperature

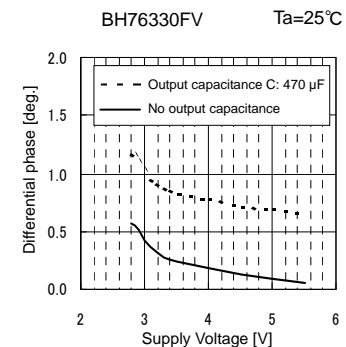

Fig.51 DP vs. Supply Voltage

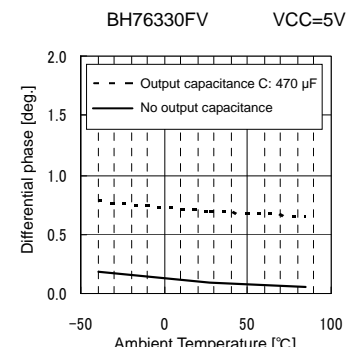

Fig.52 DP vs. Ambient Temperature

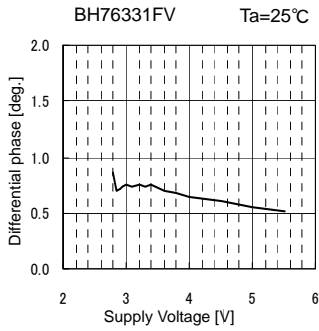

Fig.53 DP vs. Supply Voltage

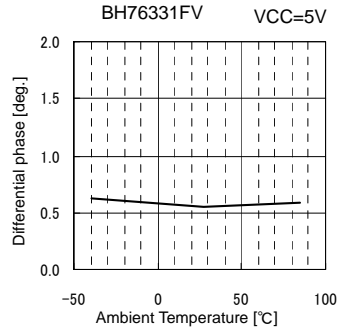

Fig.54 DP vs. Ambient Temperature

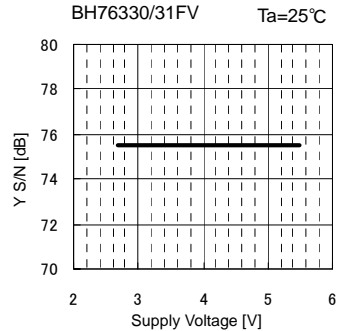

Fig.55 SN_γ vs. Supply Voltage

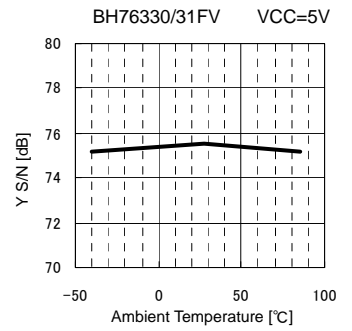

Fig.56 SN_γ vs. Ambient Temperature

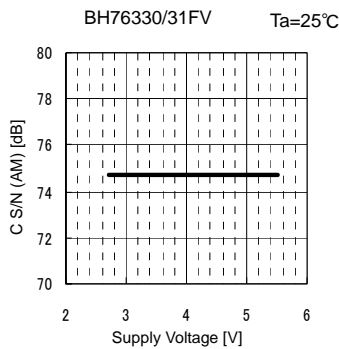

Fig.57 SN_{CA} vs. Supply Voltage

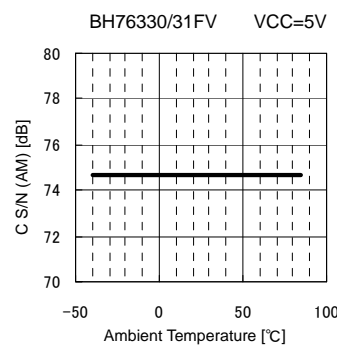

Fig.58 SN_{CA} vs. Ambient Temperature

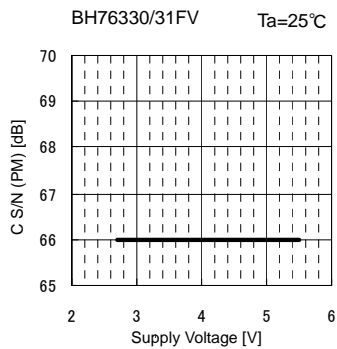

Fig.59 SN_{CP} vs. Supply Voltage

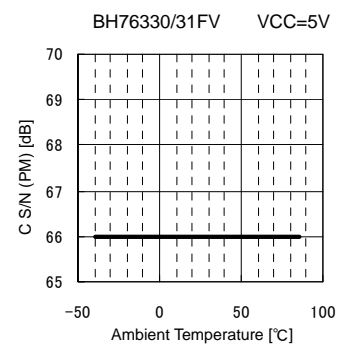

Fig.60 SN_{CP} vs. Ambient Temperature

● Reference data (2) BH76332FVM/BH76333FVM [unless otherwise specified, output capacitance C: 470 μF, RL = 10 kΩ]

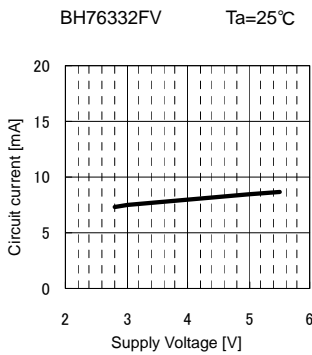

Fig.61 ICC1 vs. Supply Voltage

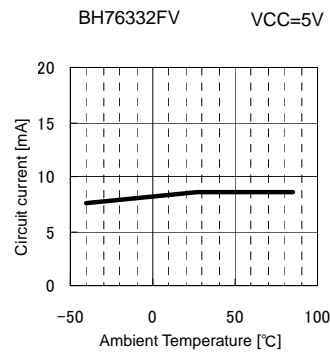

Fig.62 ICC1 vs. Ambient Temperature

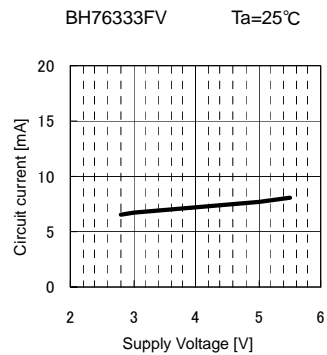

Fig.63 ICC1 vs. Supply Voltage

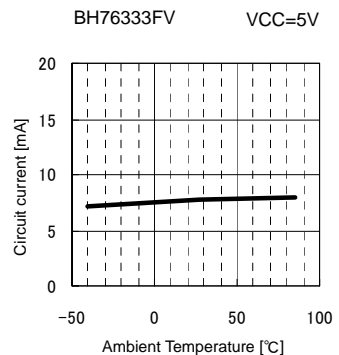

Fig.64 ICC1 vs. Ambient Temperature

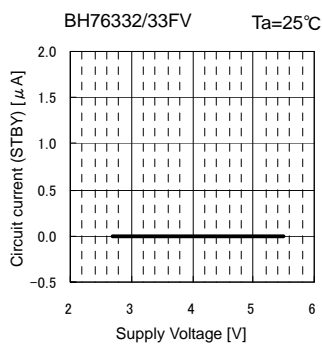

Fig.65 ICC2 vs. Supply Voltage

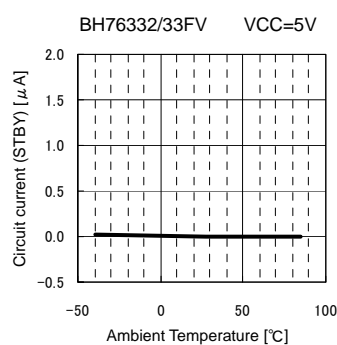

Fig.66 ICC2 vs. Ambient Temperature

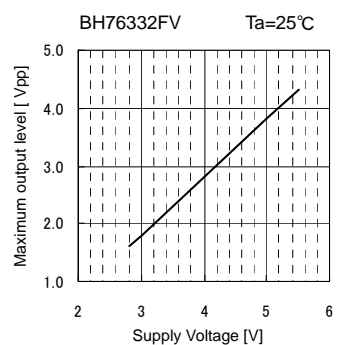

Fig.67 Vom vs. Supply Voltage

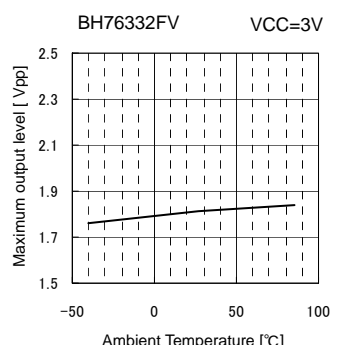

Fig.68 Vom vs. Ambient Temperature

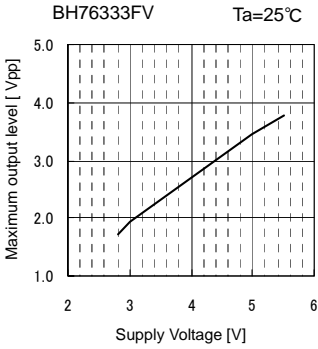

Fig.69 Vom vs. Supply Voltage

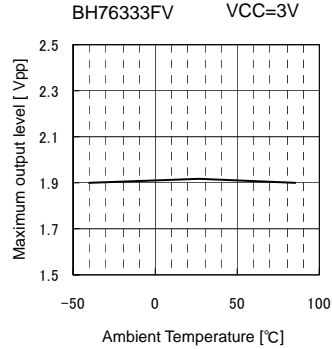

Fig.70 Vom vs. Ambient Temperature

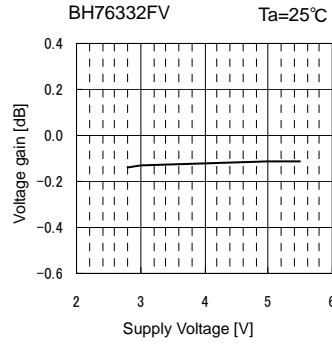

Fig.71 G_v vs. Supply Voltage

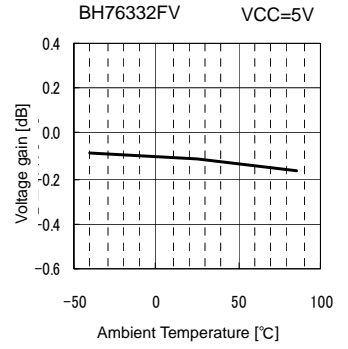

Fig.72 G_v vs. Ambient Temperature

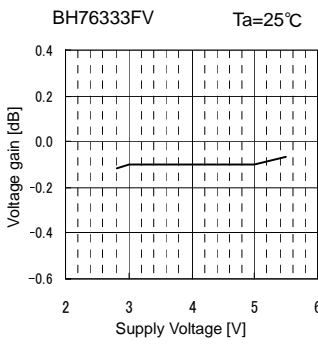

Fig.73 G_v vs. Supply Voltage

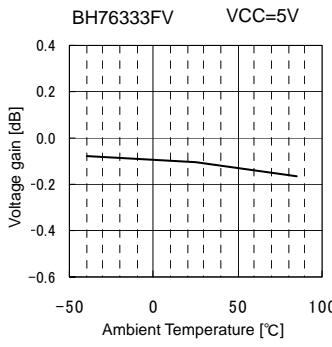

Fig.74 G_v vs. Ambient Temperature

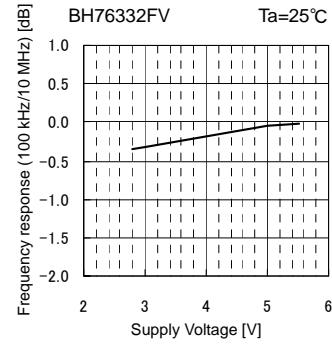

Fig.75 G_f vs. Supply Voltage

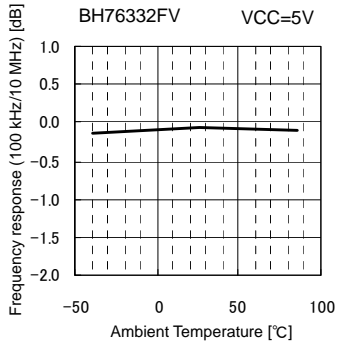

Fig.76 G_f vs. Ambient Temperature

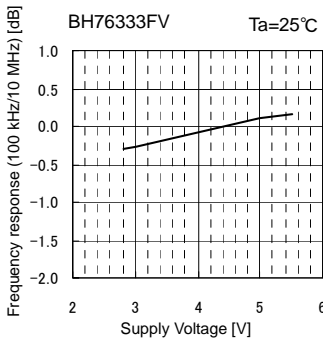

Fig.77 G_f vs. Supply Voltage

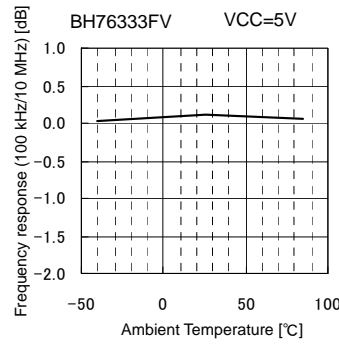

Fig.78 G_f vs. Ambient Temperature

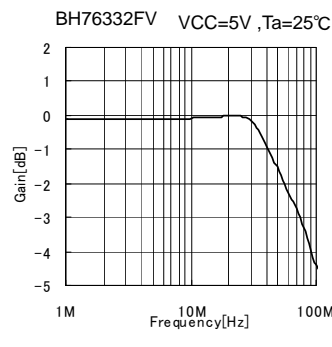

Fig.79 Frequency Response

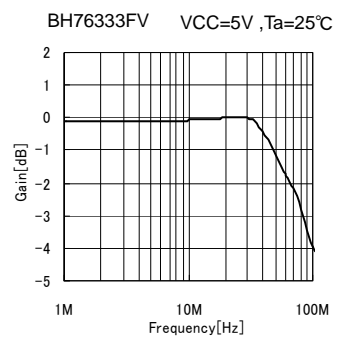

Fig.80 Frequency Response

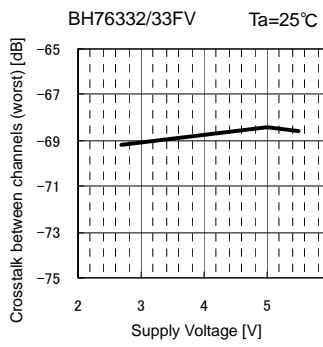

Fig.81 CT(worst) vs. Supply Voltage

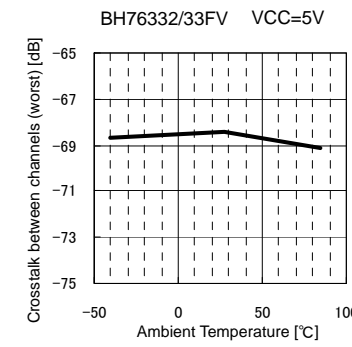

Fig.82 CT(worst) vs. Ambient Temperature

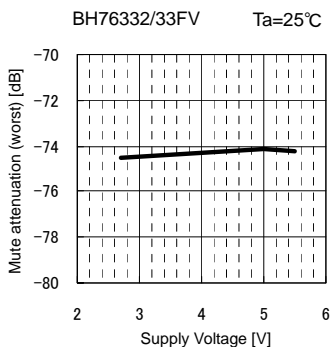

Fig.83 MT(worst) vs. Supply Voltage

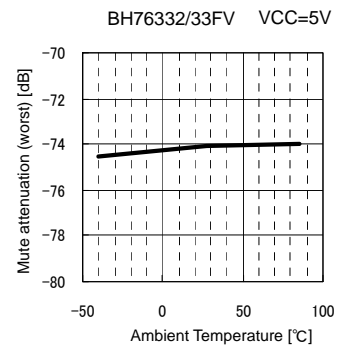

Fig.84 MT(worst) vs. Ambient Temperature

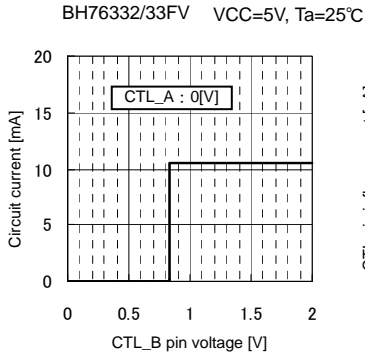

Fig.85 CTLb pin voltage vs Circuit Current (CLT threshold)

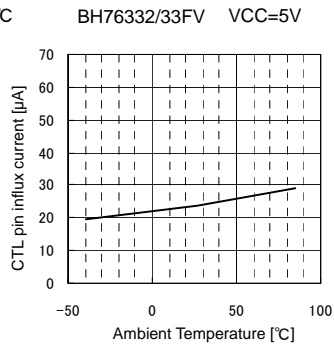

Fig.86 I_{TH} vs. Ambient Temperature (Voltage applied to CTL pin = 2V)

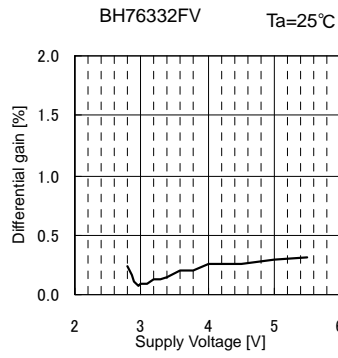

Fig.87 DG vs. Supply Voltage

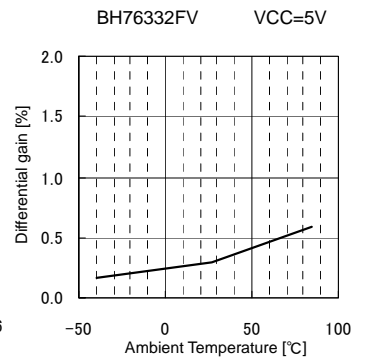

Fig.88 DG vs. Ambient Temperature

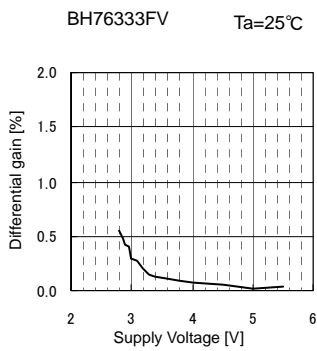

Fig.89 DG vs. Supply Voltage

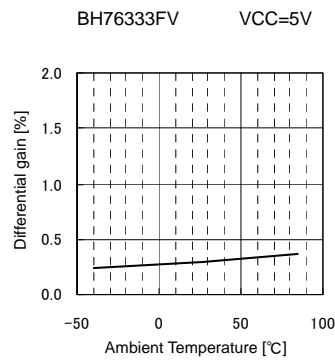

Fig.90 DG vs. Ambient Temperature

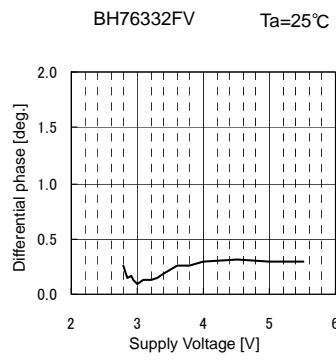

Fig.91 DP vs. Supply Voltage

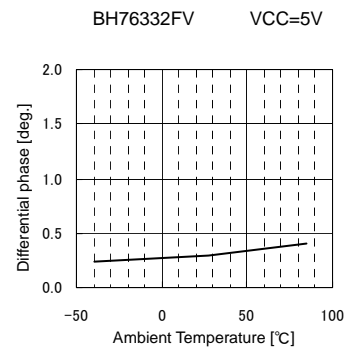

Fig.92 DP vs. Ambient Temperature

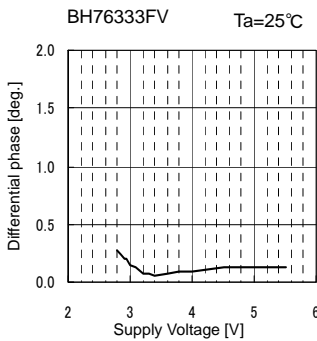

Fig.93 DP vs. Supply Voltage

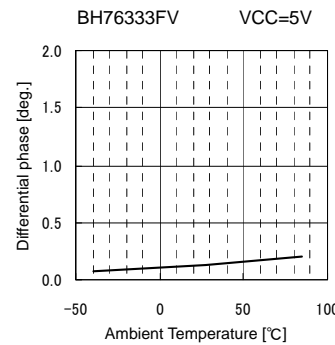

Fig.94 DP vs. Ambient Temperature

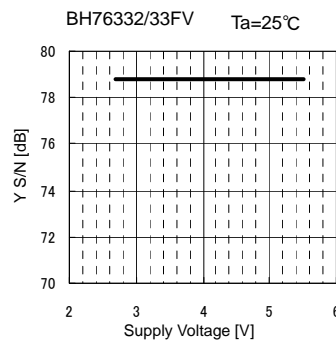

Fig.95 SN_{γ} vs. Supply Voltage

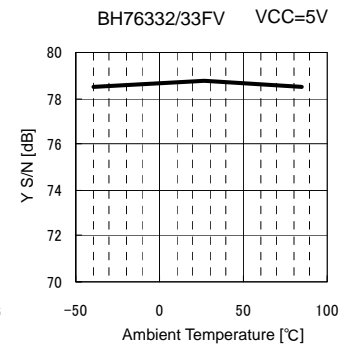

Fig.96 SN_{γ} vs. Ambient Temperature

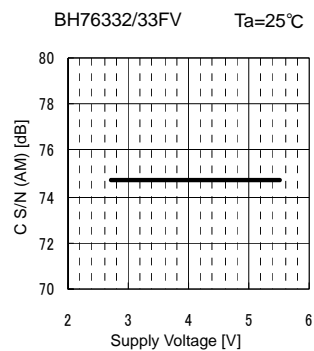

Fig.97 SN_{CA} vs. Supply Voltage

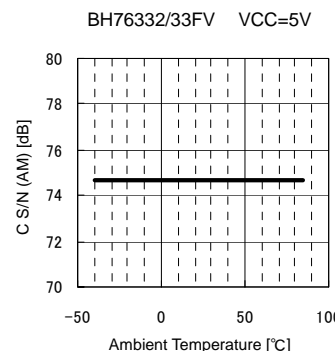

Fig.98 SN_{CA} vs. Ambient Temperature

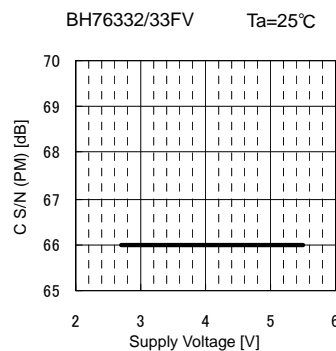

Fig.99 SN_{CP} vs. Supply Voltage

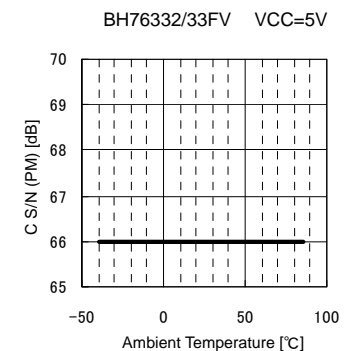

Fig.100 SN_{CP} vs. Ambient Temperature

Line-up of products with built-in video amplifier and video driver

6-input, 1-output video switch

BH76360FV, BH76361FV, BH76362FV, BH76363FV

●General

BH76360FV, BH76361FV, BH76362FV, and BH76363FV are video signal switching ICs, each with six inputs and one circuit input, which feature wide dynamic range and frequency response. Since these ICs can be used with low voltage starting at VCC = 2.8 V, they are applicable not only in stationary devices but also in mobile devices.

This product line-up supports a broad range of input signals, depending on whether or not a 6-dB video amplifier and video driver are included and what combination of sync tip clamp type and bias (resistor termination) type inputs are used.

●Features

- 1) Able to use a wide range of power supply voltage, from 2.8 V to 5.5 V
- 2) Wide output dynamic range
- 3) Excellent frequency response
(BH76360FV, BH76361FV : 100kHz/10MHz 0dB[Typ.], BH76362FV, BH76363FV : 100kHz/30MHz 0dB[Typ.])
- 4) No crosstalk between channels (Typ.-65dB, f=4.43MHz)
- 5) Built-in mute function (Typ.-65dB, f=4.43MHz)
- 6) Built-in standby function, circuit current during standby is 0 μA (Typ.)
- 7) Sync tip clamp input (BH76360FV, BH76362FV)
- 8) Bias input (Zin=150kΩ) (BH76361FV, BH76363FV)
- 9) 6-dB amp and 75Ω driver are built in (BH76360FV, BH76361FV)
- 10) Enables two load drivers [when using output coupling capacitor] (BH76360FV, BH76361FV)
- 11) Able to be used without output coupling capacitor (BH76360FV)
- 12) SSOP-B16 compact package

●Applications

Input switching in car navigation systems, TVs, DVD systems, etc.

●Line-up

	BH76360FV	BH76361FV	BH76362FV	BH76363FV
Supply voltage	2.8 V to 5.5 V			
Amp gain	6dB		-0.1dB	
Video driver	Included		-	
Frequency response	100kHz/10MHz 0dB (Typ.)		100kHz/30MHz 0dB (Typ.)	
Input type	Sync tip clamp	Bias (Zin = 150 kΩ)	Sync tip clamp	Bias (Zin = 150 kΩ)

●Absolute maximum ratings (Ta = 25°C)

Parameter	Symbol	Limits	Unit
Supply voltage	VCC	7.0	V
Power dissipation	Pd	450 *1	mW
Input voltage range	V _{IN}	0 to VCC+0.2	V
Operating temperature range	Topr	-40 to +85	°C
Storage temperature range	Tstg	-55 to +125	°C

*1 When used while Ta = 25°C, 4.7 mW is dissipated per 1°C Mounted on 70 mm x 70 mm x 1.6 mm glass epoxy board

●Operation range (Ta = 25°C)

Parameter	Symbol	Min.	Typ.	Max	Unit
Supply voltage	VCC	2.8	5.0	5.5	V

●Electrical characteristics 1 (unless otherwise specified, Ta=25°C, VCC=5V)

Parameter	Symbol	Typ.				Unit	Conditions
		76360	76361	76362	76363		
Circuit current 1	ICC1	12		11		mA	When no signal
Circuit current 2	ICC2	0.0				uA	During standby
Circuit current 3	ICC3-1	13		12		mA	During output of color bar signal
	ICC3-2	19	—				During output of color bar signal (no C in output)
Maximum output level	VOM	4.6		3.8	3.4	Vpp	f=10kHz, THD=1%
Voltage gain	G _V	6.0		-0.1		dB	Vin=1.0Vpp, f=100kHz
Frequency response	G _{F1}	0		—		dB	Vin=1.0Vpp, f=10MHz/100kHz
	G _{F2}	—		0		dB	Vin=1.0Vpp, f=30MHz/100kHz
Crosstalk between channels	C _T	-65				dB	Vin=1.0Vpp, f=4.43MHz
Mute attenuation	M _T	-65				dB	Vin=1.0Vpp, f=4.43MHz
CTL pin switch level	V _{THH}	1.2 _{Min}				V	High Level threshold voltage
	V _{THL}	0.45 _{Max}				V	Low Level threshold voltage
CTL pin inflow current	I _{THH}	50 _{Max}				uA	CTL pin = 2.0 V applied
Input impedance	Z _{in}	—	150	—	150	kΩ	
Differential gain	D _G	0.3				%	Vin=1.0Vpp
Differential phase	D _{P-1}	0.7		0.3		deg.	Standard stair step signal
	D _{P-2}	0.0	—				Same condition as above (no C in output)
Y-related S/N	SN _Y	+75		+78		dB	Vin = 1.0 Vpp, bandwidth: 100 k to 6 MHz 100% white video signal
C-related S/N [AM]	SN _{CA}	+75				dB	Vin = 1.0 Vpp, bandwidth: 100 to 500 kHz 100% chroma voltage signal
C-related S/N [PM]	SN _{CP}	+65					

●Electrical characteristics 2 (unless otherwise specified, Ta = 25°C, VCC = 3 V)

Parameter	Symbol	Typ.				Unit	Conditions
		76360	76361	76362	76363		
Circuit current 1	ICC1	10				mA	When no signal
Circuit current 2	ICC2	0.0				uA	During standby
Circuit current 3	ICC3-1	11		10		mA	During output of color bar signal
	ICC3-2	17	—				During output of color bar signal (no C in output)
Maximum output level	VOM	2.7	2.8	1.8	1.9	Vpp	f=10kHz, THD=1%
Voltage gain	G _V	6.0		-0.1		dB	Vin=1.0Vpp, f=100kHz
Frequency response	G _{F1}	0		—		dB	Vin=1.0Vpp, f=10MHz/100kHz
	G _{F2}	—		0		dB	Vin=1.0Vpp, f=30MHz/100kHz
Crosstalk between channels	C _T	-65				dB	Vin=1.0Vpp, f=4.43MHz
Mute attenuation	M _T	-65				dB	Vin=1.0Vpp, f=4.43MHz
CTL pin switch level	V _{THH}	1.2 _{Min}				V	High Level threshold voltage
	V _{THL}	0.45 _{Max}				V	Low Level threshold voltage
CTL pin inflow current	I _{THH}	50 _{Max}				uA	CTL pin = 2.0 V applied
Input impedance	Z _{in}	—	150	—	150	kΩ	
Differential gain	D _G	0.3				%	Vin=1.0Vpp
Differential phase	D _{P-1}	1.0		0.3		deg.	Standard stair step signal
	D _{P-2}	0.5	—				Same condition as above (no C in output)
Y-related S/N	SN _Y	+75		+78		dB	Vin = 1.0 Vpp, bandwidth: 100 k to 6 MHz 100% white video signal
C-related S/N [AM]	SN _{CA}	+75				dB	Vin = 1.0 Vpp, bandwidth: 100 to 500 kHz 100% chroma video signal
C-related S/N [PM]	SN _{CP}	+65					

(Note) Re: ICC3, VOM, G_V, G_F, C_T, M_T, D_G, D_P, SN_Y, SN_{CA}, SN_{CP} parameters
 BH76360FV, BH76361FV: RL = 150 Ω
 BH76362FV, BH76363FV: RL = 10 kΩ

●Control pin settings

	CTLA	CTLB	CTLC	CTLD
IN1	L(OPEN)	L(OPEN)	L(OPEN)	H
IN2	H	L(OPEN)	L(OPEN)	H
IN3	L(OPEN)	H	L(OPEN)	H
IN4	H	H	L(OPEN)	H
IN5	L(OPEN)	L(OPEN)	H	H
IN6	H	L(OPEN)	H	H
MUTE	*	H	H	H
STBY	*	*	*	L(OPEN)

* L(OPEN) or H either is possible

●Block diagram

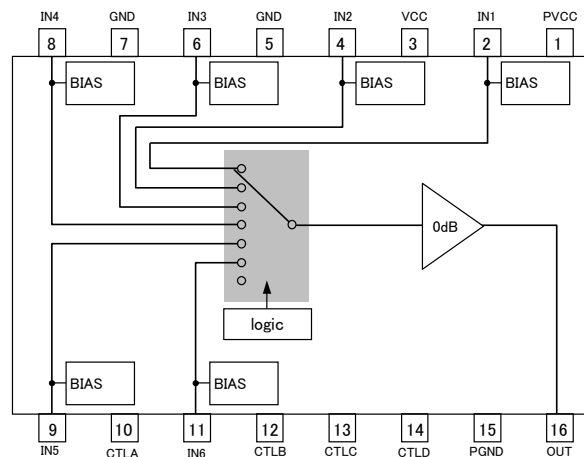
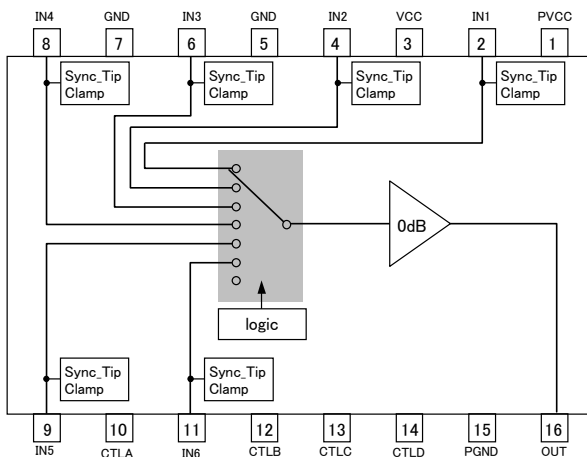
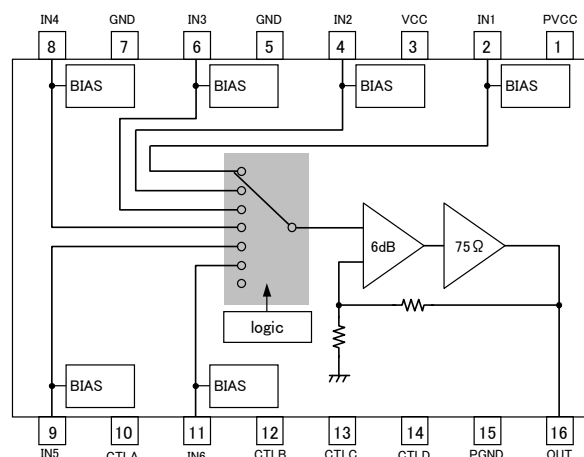
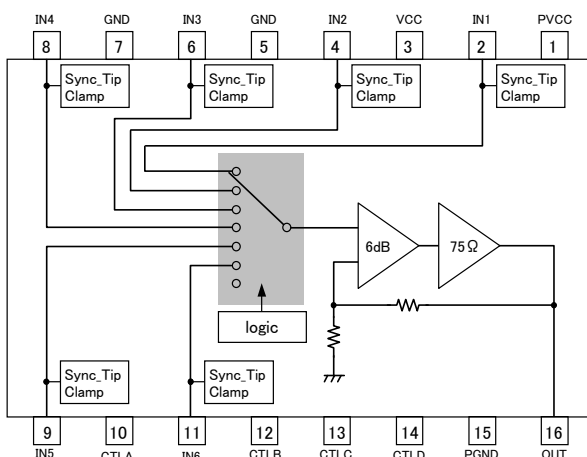

● I/O equivalent circuit diagrams

Input pins

Sync tip clamp input BH76360FV / BH76362FV			Bias input BH76361FV / BH76363FV		
PIN No.	Name	Equivalent circuit	PIN No.	Name	Equivalent circuit
2	IN1		2	IN1	
4	IN2		4	IN2	
6	IN3		6	IN3	
8	IN4		8	IN4	
9	IN5		9	IN5	
11	IN6		11	IN6	
Video signal input pin is used for sync tip clamp input. • DC potential BH76360FV : 1.5V BH76362FV : 1.0V			Video signal input pin is used for bias type input. Input impedance is 150 kΩ. • DC potential BH76361FV : 3.1V BH76363FV : 2.5V		

Control pins

PIN No.	Name	Equivalent circuit
10	CTLA	
12	CTLB	
13	CTLC	
14	CTLD	
Switches operation mode [active or standby] and input pin. Threshold level is 0.45 V to 1.2 V.		

Output pin

With video driver BH76360FV / BH76361FV			Without video driver BH76362FV / BH76363FV		
PIN No.	Name	Equivalent circuit	PIN No.	Name	Equivalent circuit
16	OUT		16	OUT	
Video signal output pin. Able to drive loads up to 75 Ω (dual drive). • DC potential BH76360FV : 0.16V BH76361FV : 2.5V			Video signal output pin. • DC potential BH76362FV : 0.3V BH76363FV : 1.8V		

Note 1) The above DC potential is only when VCC = 5 V. This value is a reference value and is not guaranteed.

Note 2) Numerical values shown in these figures are design values, and compliance to standards is not guaranteed.

● Test Circuit Diagrams

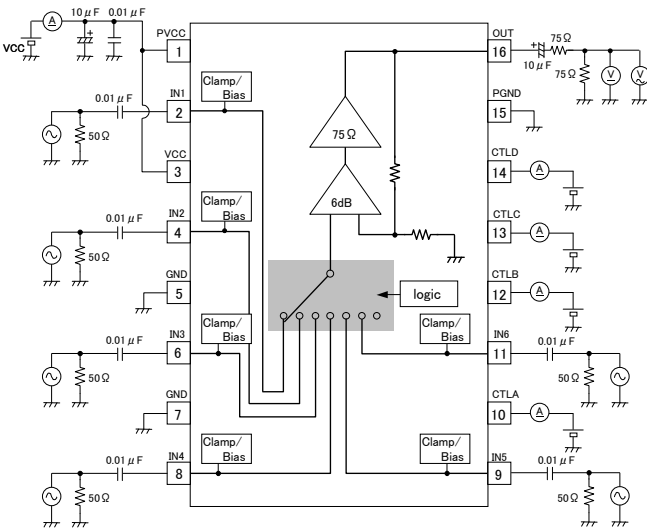

Fig.5 BH76360FV/BH76361FV Test Circuit Diagram

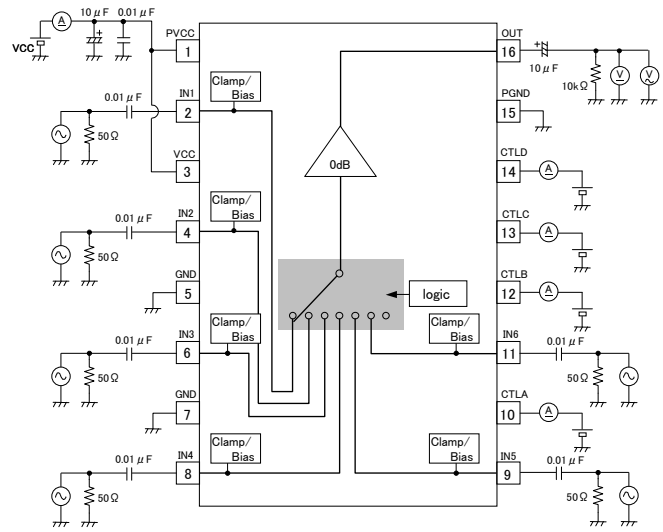

Fig.6 BH76362FV/BH76363FV Test Circuit Diagram

Test circuit diagrams are used for shipment inspections, and differ from application circuits.

● Application circuit examples

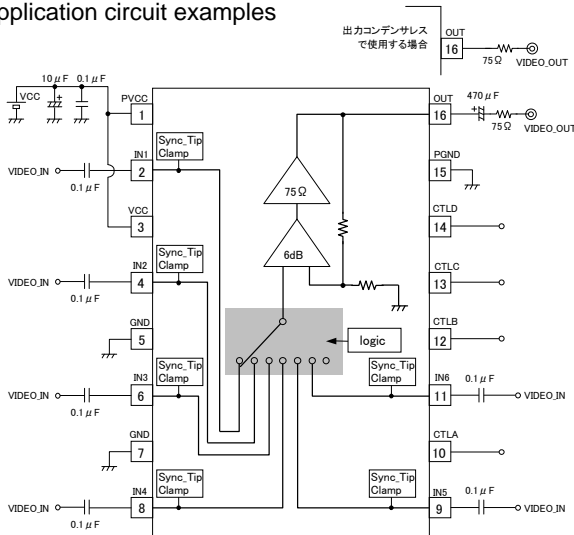

Fig.7 BH76360FV

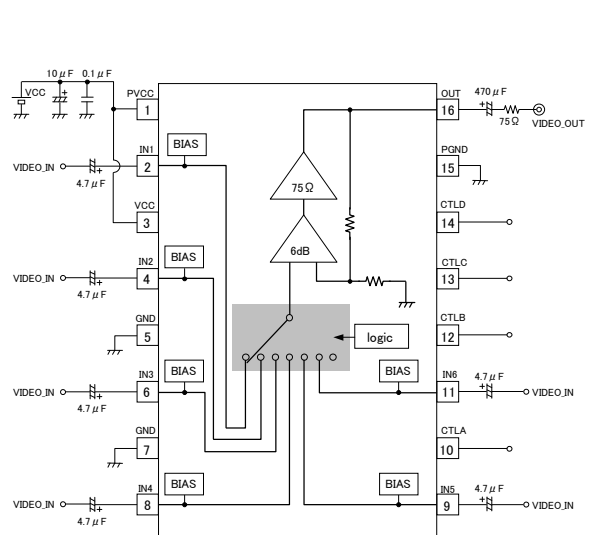

Fig.8 BH76361FV

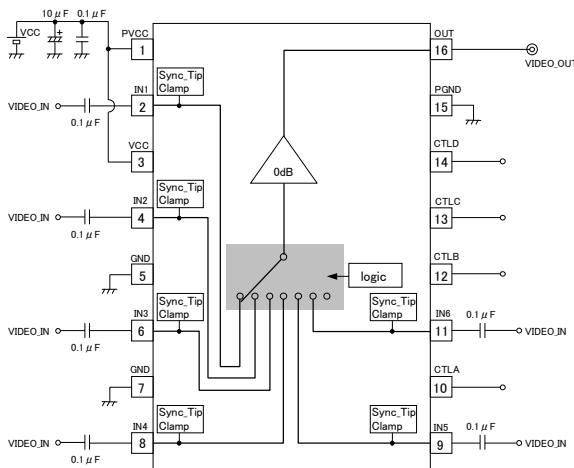

Fig.9 BH76362FV

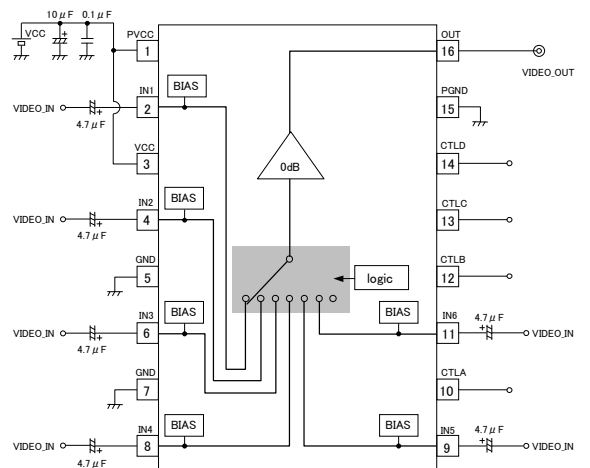

Fig.10 BH76363FV

See pages 6/16 to 10/16 for description of how to determine the capacity of I/O coupling capacitors.

●Cautions for selection and use of application parts

When using this IC by itself ①

Input type	Input impedance Zin	Capacity of input coupling capacitor (recommended value)	Capacity of output coupling capacitor (recommended value)
Sync_Tip_Clamp	10MΩ	0.1uF	470uF~1000uF
Bias	150kΩ	4.7uF	

Method for determining capacity of input coupling capacitor

The HPF is comprised of an input coupling capacitor and the internal input impedance Zin of the IC. Since the fc value of this HPF is determined using the following equation (a), the above recommended capacity for the input capacitor is derived. Usually, the cutoff frequency fc is several Hz.

$$f_c = 1 / (2\pi \times C \times Z_{in}) \dots (a)$$

When evaluating the sag characteristics and determining the capacity of the capacitor during video signal input, a horizontal stripe signal called "H bar" (shown in Fig. 10) is suitable, and this type of signal is used instead of a color bar signal to evaluate characteristics and determine capacity.



Fig.11 Example of Screen with Obvious Sag (H-bar Signal)

Method for determining capacity of output coupling capacitor

The output pins of models with a 75Ω driver [BH76360FV and BH76361FV] have an HPF comprised of an output coupling capacitor and load resistance RL (= 150Ω). When fc is set to approximately 1 Hz or 2 Hz, the capacity of the output coupling capacitor needs to be approximately 470 μF to 1000 μF.

As for models without the 75Ω driver, an HPF is similarly comprised using the capacity of the output coupling capacitor and the input impedance of the IC connected at the next stage, and the capacitance required for the output coupling capacitor should be estimated using equation (a).

When this IC is used as a standalone device ②

In models that include a 75Ω driver [BH76360FV and BH76361FV], up to two monitors (loads) can be connected (a connection example is shown in Fig. 12). When there are multiple loads, the number of output coupling capacitors must be increased or a larger capacitance must be used, based on the table shown below.

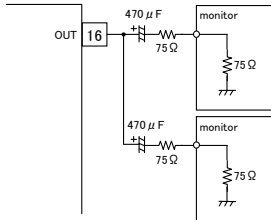

Fig. 12 (a) Application Circuit Example 1 (Two Drives)

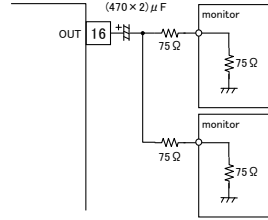

Fig. 12 (b) Application Circuit Example 2 (Two Drives)

Application circuit example	No. of output capacitors	Capacitance per output capacitor (recommended values)
Fig12(a)	No. of drives required	470 μF to 1000 μF (same as with one drive)
Fig12(b)	1	(No. of drive × 470 μF to 1000) uF

When this IC is used as a standalone device ③

The BH76360FV is the only model that can be used without an output coupling capacitor.

This use method not only enables reductions in board space and part-related costs, but it is able to improve the sag characteristics by improving low-range frequency response. However, when the output coupling capacitor is omitted, a direct current flows to the connected set, so the specifications of the connected set should be noted carefully before starting use.

Note also that only one load can be connected when the output coupling capacitor is omitted.

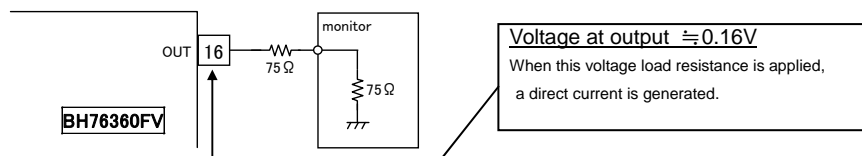

Fig.13 Application Example without Output Coupling Capacitor

When using several of these ICs ①

When several of these ICs are used, it enables applications in which separate images are output to the car navigation system's front and rear monitors.

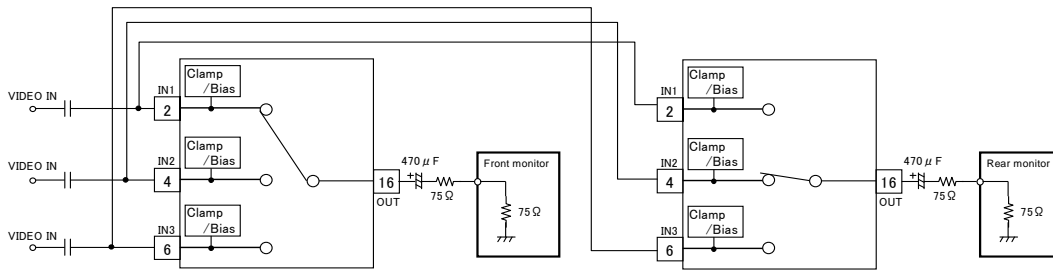

Fig.14 Application Example when Using Several ICs

When several ICs are used at the same time, the number of parallel connections of input impedance equals the number of ICs being used, which reduces the input impedance. This also raises the f_c value of the HPF formed at the input pin block, so the capacitance of the input coupling capacitor must be increased according to equation (a). The recommended values for calculation results are listed in the table below.

When a clamp is used as the input type, the original input impedance becomes much greater, and if two or three are used at the same time there is no need to change the capacitance of the input coupling capacitor.

Input type	Input impedance per IC	Number of ICs used	Total input impedance	Capacitance of input coupling capacitor (recommended values)
Sync_Tip_Clamp	Approx. 10 MΩ	2	Approx. 5 MΩ	0.1uF
		3	Approx. 3 MΩ	0.1uF
Bias	150k Ω	2	75k Ω	6.8uF~
		3	50k Ω	10uF~

When using several of these ICs ②

When three bias input type models (BH76361FV or BH76363FV) are used in parallel, they can be used for RGB signal switching applications. Likewise, when one clamp input type model (BH76360FV or BH76362FV) is connected in parallel with two bias input type models (a total of three ICs used in parallel), they can be used for component signal switching applications. The same method can be used to determine the capacitance of I/O coupling capacitors of these applications.

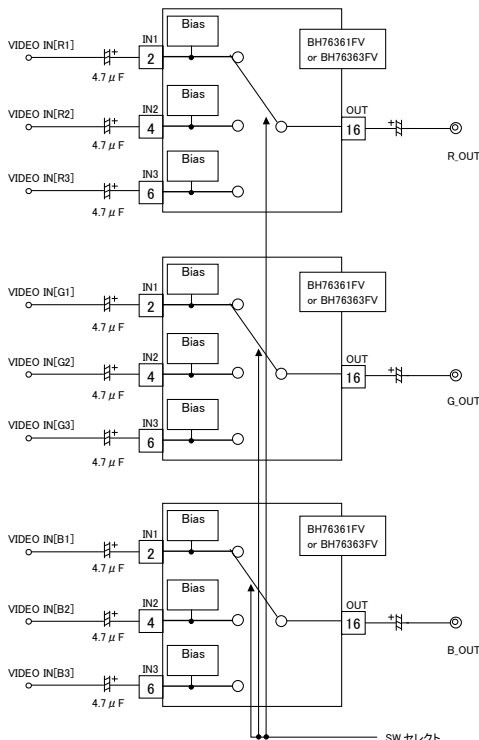

Fig. 15 (a). RGB Signal Switching Application Example (using three bias input type models in parallel)

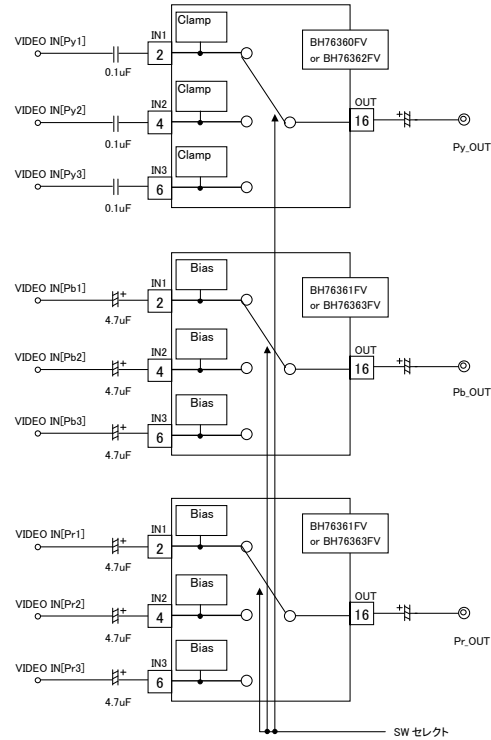

Fig. 15 (b). Component Signal Switching Application Example (using one clamp input type model and two bias input type models in parallel)

●Cautions for use

1. The numerical values and data shown here are typical design values, not guaranteed values.
2. The application circuit examples show recommended circuits, but characteristics should be checked carefully before using these circuits. If any external part constants are modified before use, factors such as variation in all external parts and ROHM LSI ICs, including not only static characteristics but also transient characteristics, should be fully considered to set an ample margin.
3. Absolute maximum ratings
If the absolute maximum ratings for applied voltage and/or operation temperature are exceeded, LSI damage may result. Therefore, do not apply voltage or use in a temperature that exceeds these absolute maximum ratings. If it is possible that absolute maximum ratings will be exceeded, use a physical safety device such as a fuse and make sure that no conditions that might exceed the absolute maximum ratings will be applied to the LSI IC.
4. GND potential
Regardless of the operation mode, the voltage of the GND pin should be at least the minimum voltage. Actually check whether or not the voltage at each pin, including transient phenomena, is less than the GND pin voltage.
5. Thermal design
The thermal design should be done using an ample margin that takes into consideration the allowable dissipation under actual use conditions.
6. Shorts between pins and mounting errors
When mounting LSI ICs onto the circuit board, make sure each LSI's orientation and position is correct. The ICs may become damaged if they are not mounted correctly when the power is turned on. Similarly, damage may also result if a short occurs, such as when a foreign object is positioned between pins in an IC, or between a pin and a power supply or GND connection.
7. Operation in strong electromagnetic field
When used within a strong electromagnetic field, evaluate carefully to avoid the risk of operation faults.
8. Place the power supply's decoupling capacitor as close as possible to the VCC pin (PIN 1, PIN3) and GND pin (PIN 5, PIN7, PIN15).
9. With a clamp input type model (BH76360FV or BH76362FV), if any unused input pins are left open they will oscillate, so unused input pins should instead be connected to GND via a capacitor or else directly connected to VCC.
10. With models that do not include a 75Ω driver (BH76362FV or BH76363FV), in some cases the capacitance added to the set board may cause the peak frequency response to occur at a high frequency. To lower the peak frequency, connect in series resistors having resistance of several dozen Ω to several hundred Ω as close as possible to the output pin.

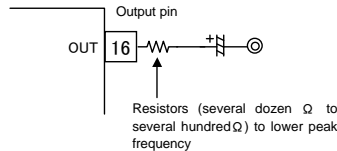

Fig.16 Positions where Resistors are Inserted to Lower Peak Frequency Response in BH76362FV or BH76363FV

11. Frequency response in models that do not include a 75-Ω driver (BH76362FV and BH76363FV) was measured as 100 kHz/30 MHz: 0 dB (Typ.) in the application circuit examples (shown in Fig. 9 and Fig. 10), and when resistance of about 1 or 2 kΩ is applied from the IC's output pin to GND, this frequency response can be improved (the lower limit of the applied resistance should be 1 kΩ). In such cases, gain is reduced, since the output voltage is divided by the added resistance and the output resistance of the IC.

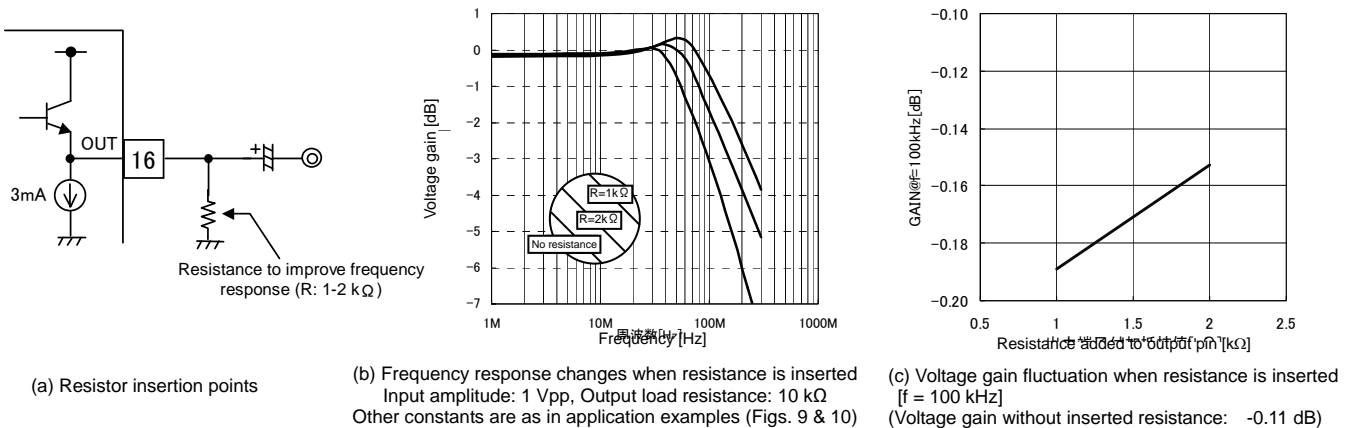

Fig.17 Result of Resistance Inserted to Improve BH76362FV/BH76363FV Frequency Response

12. With clamp input type models (BH76360FV and BH76362FV), if the termination impedance of the video input pin becomes higher, sync contractions or oscillation-related problems may occur. Evaluate temperature and other characteristics carefully and use at 1 k Ω or less.

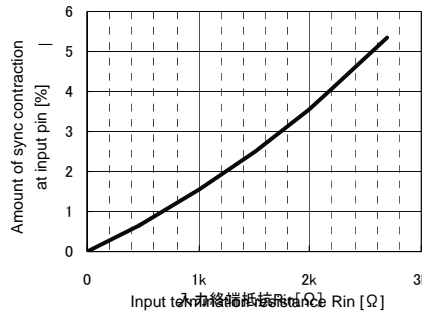

Fig. 18. Relation between Input Pin Termination Impedance and Amount of Sync Contraction

● Evaluation board pattern diagram and circuit diagram

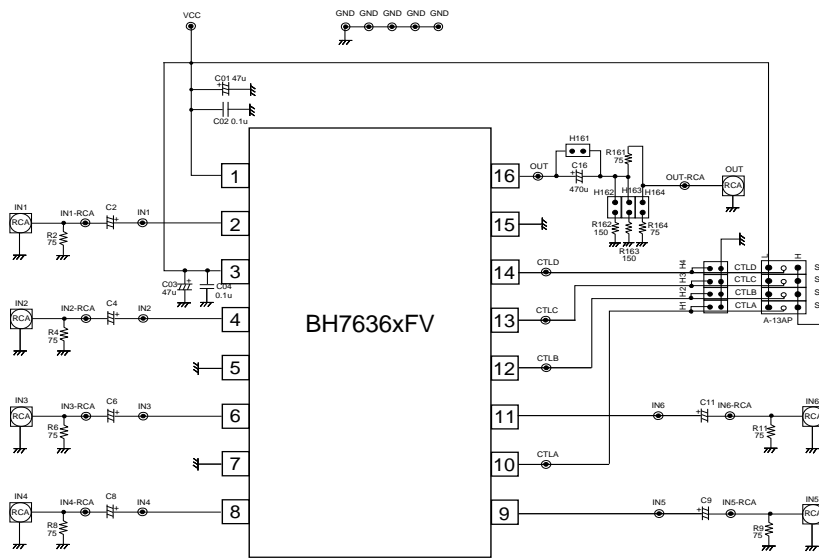

Fig.19 Evaluation Board Circuit Diagram

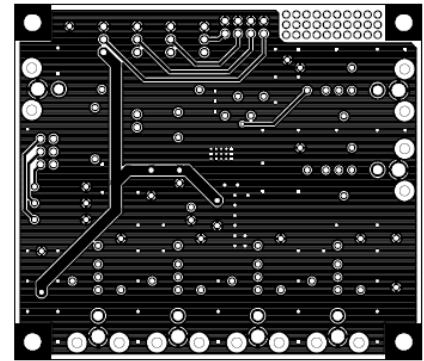
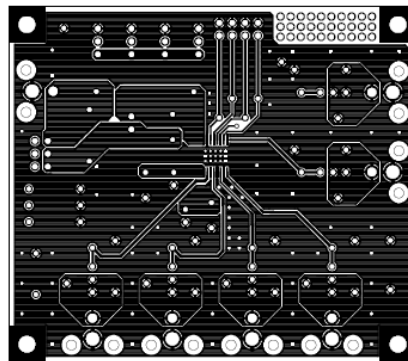
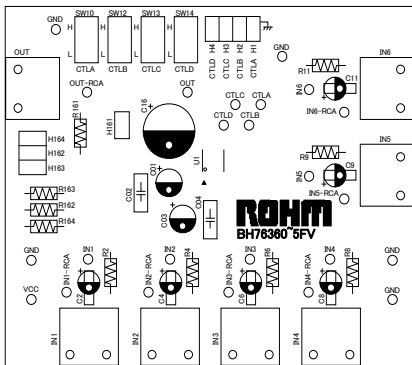

Fig.20 Evaluation Board Pattern Diagram

Parts list

Symbol	Function	Recommended value	Comments
R2 R4 R6 R8 R9 R11	Input terminating resistor	75 Ω	—
C2 C4 C6 C8 C9 C11	Input coupling capacitor	See pages 6/16 to 7/16 to determine	B characteristics recommended
R161	Output resistor	75 Ω	—
C16	Output coupling capacitor	See pages 6/16 to 7/16 to determine	B characteristics recommended
C01(C03) C02(C04)	Decoupling capacitor	10 μ F 0.1 μ F	B characteristics recommended

● Reference data (1) BH76360FV / BH76361FV [unless otherwise specified, output capacitance C: 470 μ F, RL = 150 Ω]

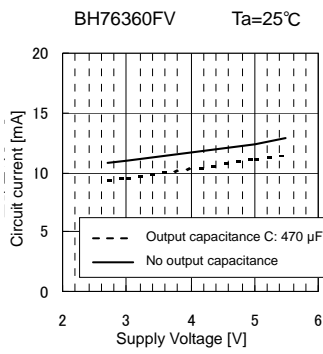

Fig.21 ICC1 vs. Supply Voltage

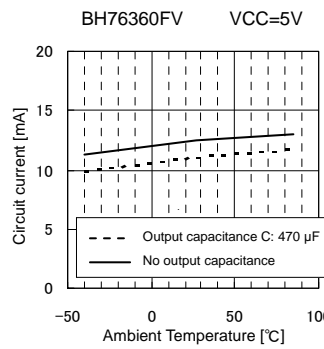

Fig.22 ICC1 vs. Ambient Temperature

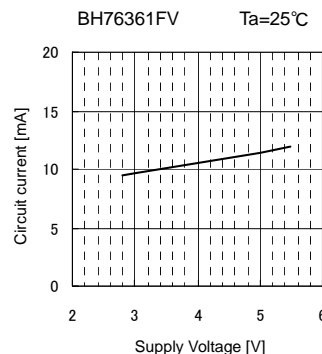

Fig.23 ICC1 vs. Supply Voltage

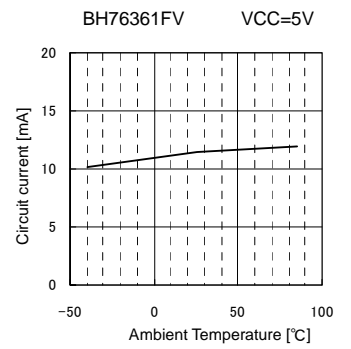

Fig.24 ICC1 vs. Ambient Temperature

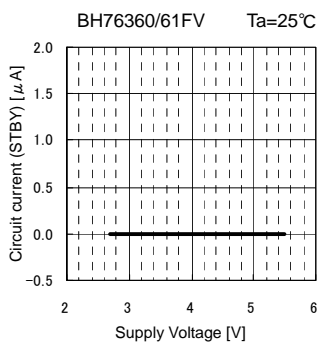

Fig.25 ICC2 vs. Supply Voltage

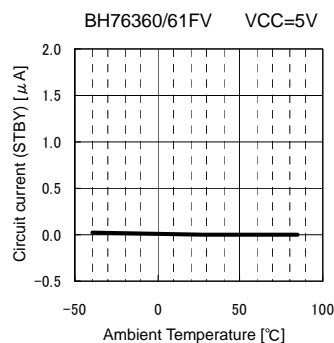

Fig.26 ICC2 vs. Ambient Temperature

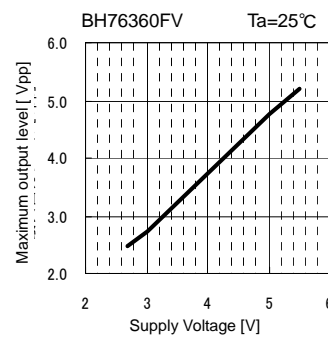

Fig.27 Vom vs. Supply Voltage

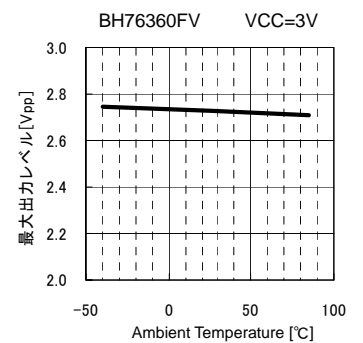

Fig.28 Vom vs. Ambient Temperature

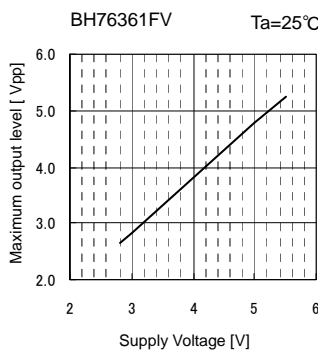

Fig.29 Vom vs. Supply Voltage

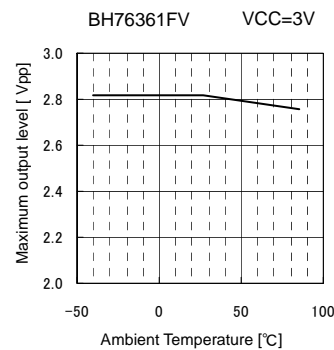

Fig.30 Vom vs. Ambient Temperature

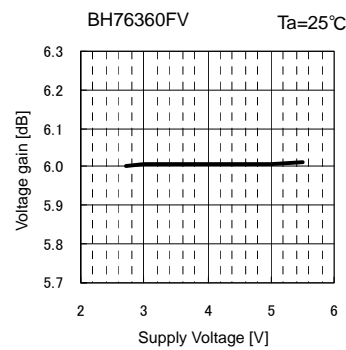

Fig.31 G_v vs. Supply Voltage

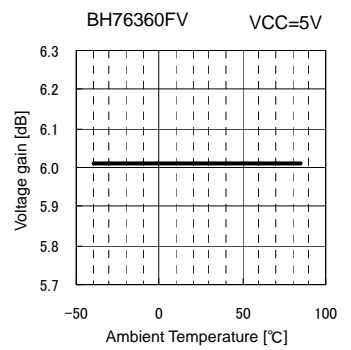

Fig.32 G_v vs. Ambient Temperature

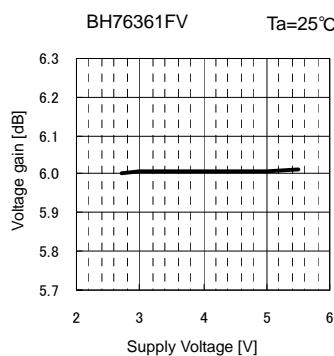

Fig.33 G_v vs. Supply Voltage

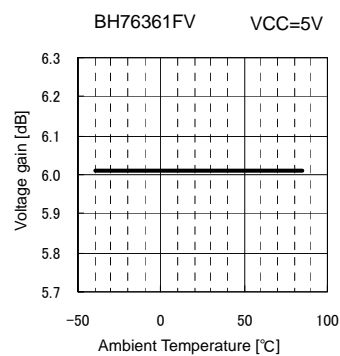

Fig.34 G_v vs. Ambient Temperature

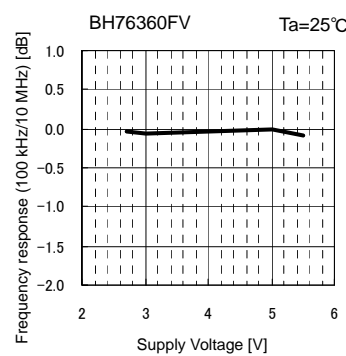

Fig.35 G_f vs. Supply Voltage

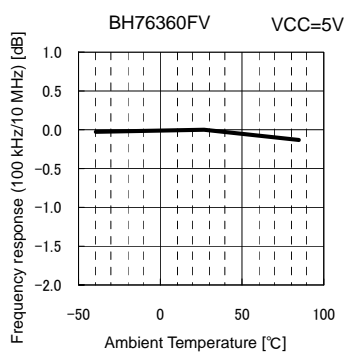

Fig.36 G_f vs. Ambient Temperature

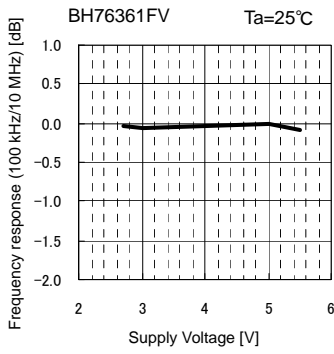

Fig.37 G_F vs. Supply Voltage

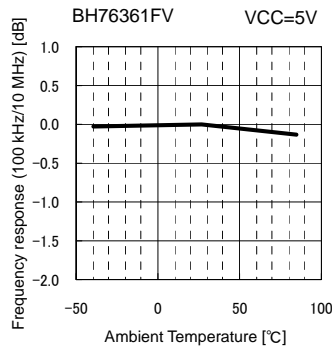

Fig.38 G_F vs. Ambient Temperature

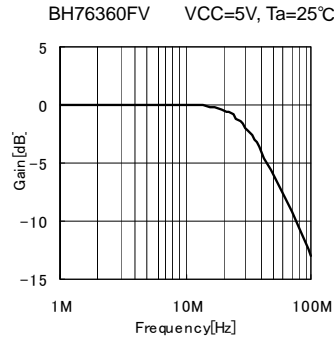

Fig.39 Frequency Response

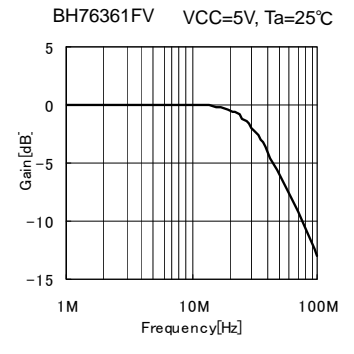

Fig.40 Frequency Response

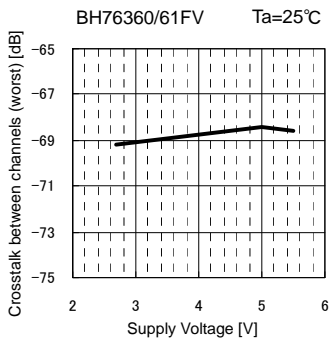

Fig.41 CT(worst) vs. Supply Voltage

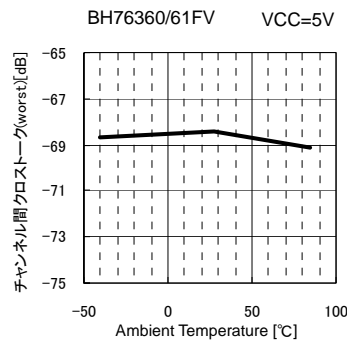

Fig.42 CT(worst) vs. Ambient Temperature

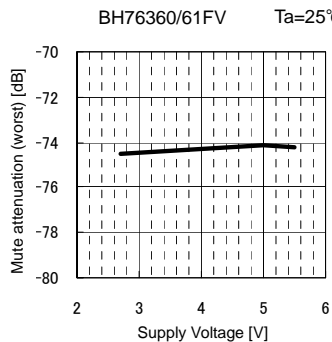

Fig.43 MT(worst) vs. Supply Voltage

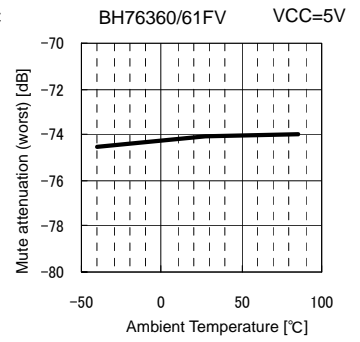

Fig.44 MT(worst) vs. Ambient Temperature

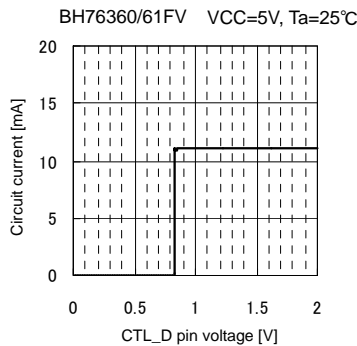

Fig.45 CTLd pin voltage vs Circuit Current (CLT threshold)

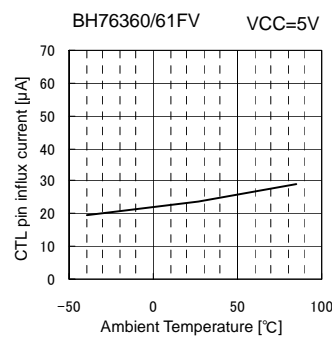

Fig.46 I_{THH} vs. Ambient Temperature (Voltage applied to CTL pin = 2V)

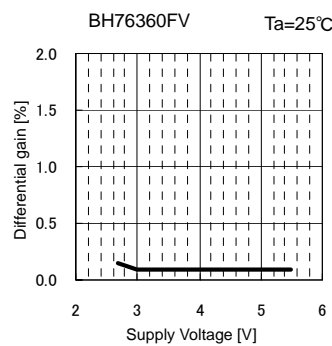

Fig.47 DG vs. Supply Voltage

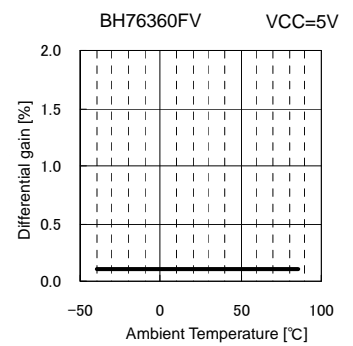

Fig.48 DG vs. Ambient Temperature

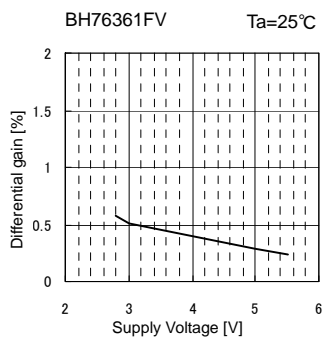

Fig.49 DG vs. Supply Voltage

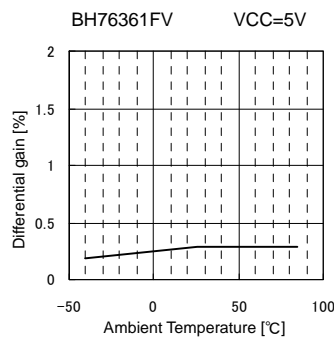

Fig.50 DG vs. Ambient Temperature

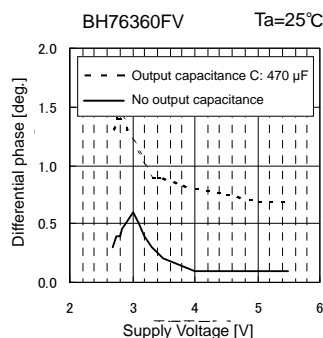

Fig.51 DP vs. Supply Voltage

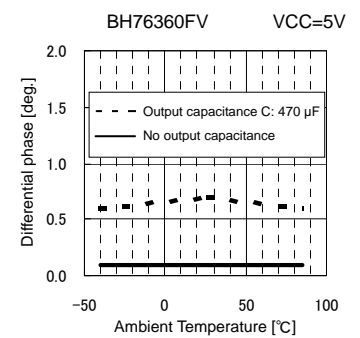

Fig.52 DP vs. Ambient Temperature

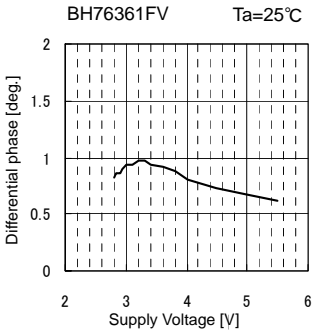

Fig.53 DP vs. Supply Voltage

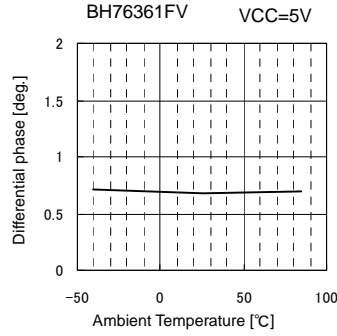

Fig.54 DP vs. Ambient Temperature

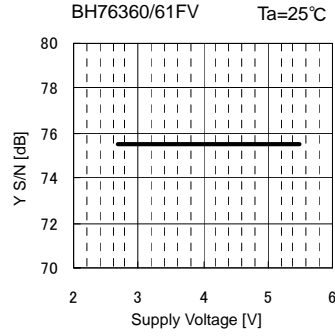

Fig.55 SN γ vs. Supply Voltage

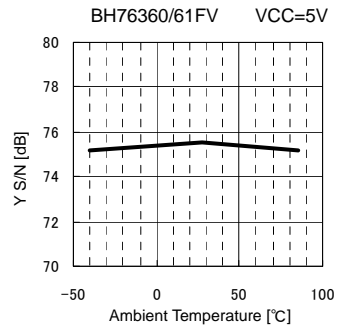

Fig.56 SN γ vs. Ambient Temperature

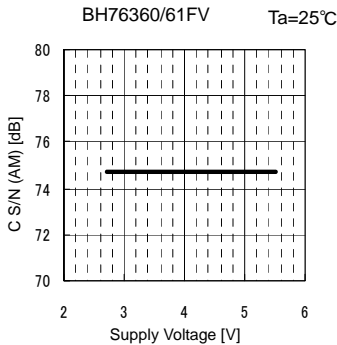

Fig.57 SN_{CA} vs. Supply Voltage

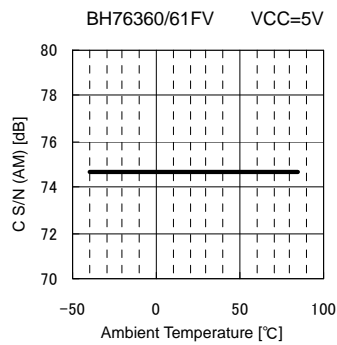

Fig.58 SN_{CA} vs. Ambient Temperature

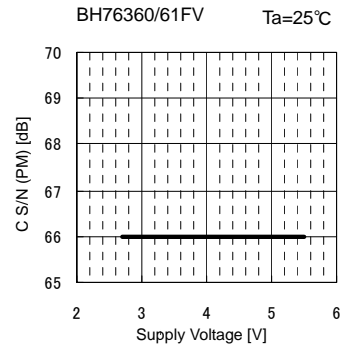

Fig.59 SN_{CP} vs. Supply Voltage

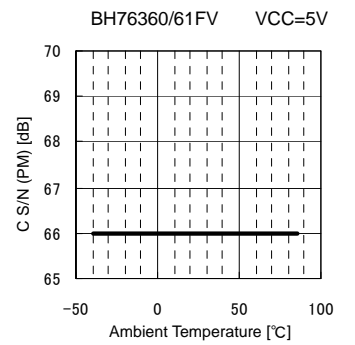

Fig.60 SN_{CP} vs. Ambient Temperature

● Reference data (2) BH76362FV/BH76363FV [unless otherwise specified, output capacitance C: 470 μ F, RL = 10 k Ω]

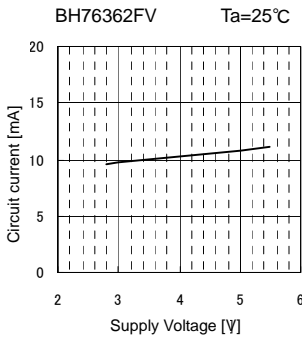

Fig.61 ICC1 vs. Supply Voltage

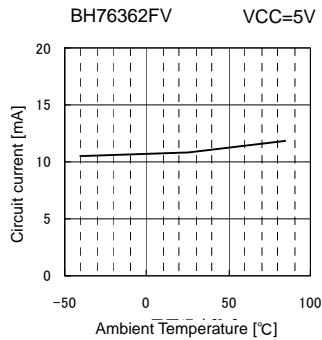

Fig.62 ICC1 vs. Ambient Temperature

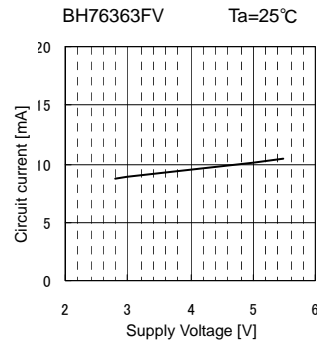

Fig.63 ICC1 vs. Supply Voltage

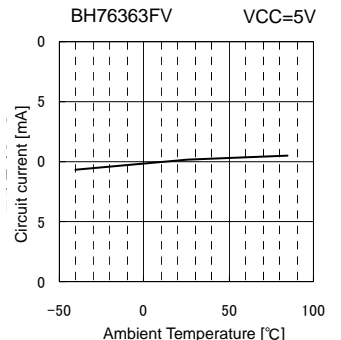

Fig.64 ICC1 vs. Ambient Temperature

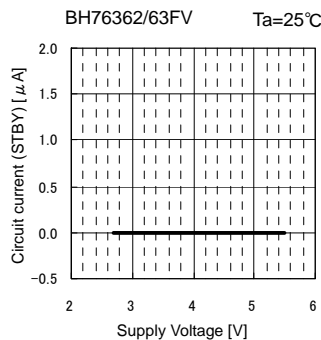

Fig.65 ICC2 vs. Supply Voltage

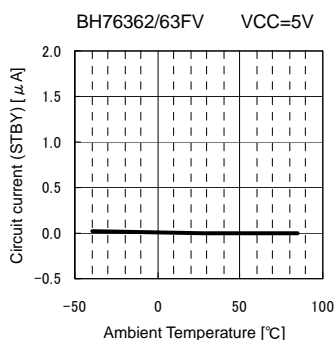

Fig.66 ICC2 vs. Ambient Temperature

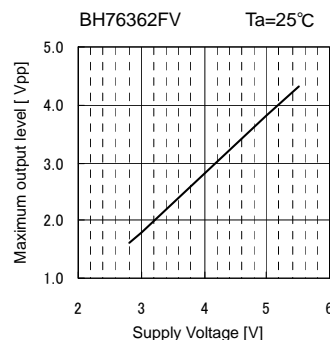

Fig.67 Vom vs. Supply Voltage

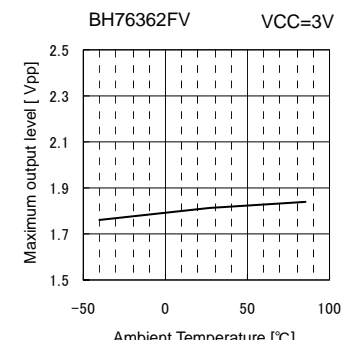

Fig.68 Vom vs. Ambient Temperature

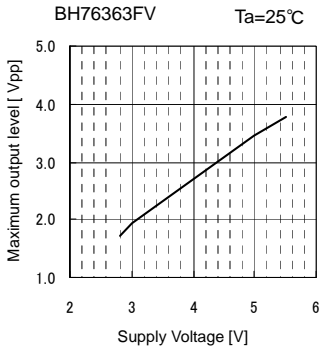

Fig.69 Vom vs. Supply Voltage

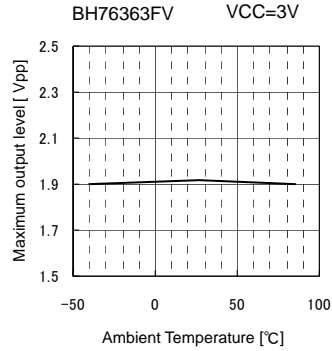

Fig.70 Vom vs. Ambient Temperature

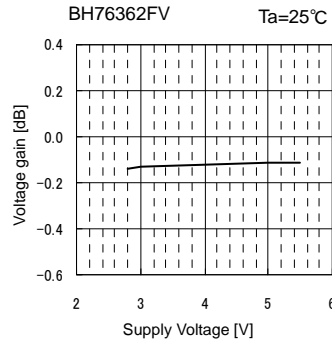

Fig.71 G_V vs. Supply Voltage

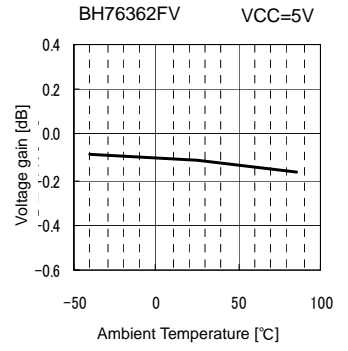

Fig.72 G_V vs. Ambient Temperature

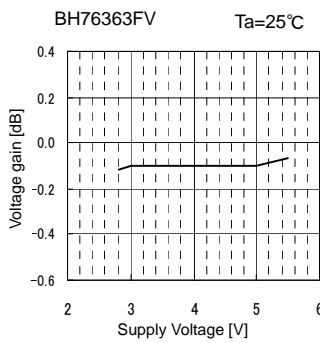

Fig.73 G_V vs. Supply Voltage

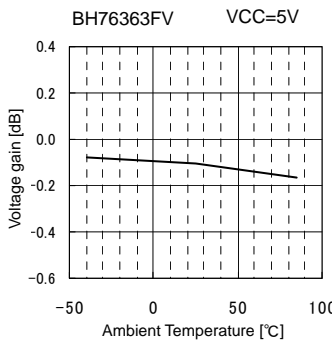

Fig.74 G_V vs. Ambient Temperature

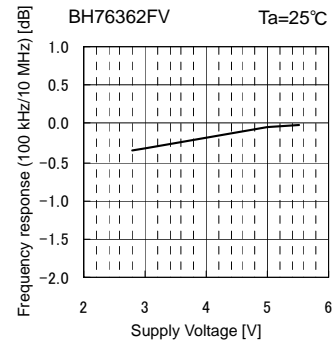

Fig.75 G_F vs. Supply Voltage

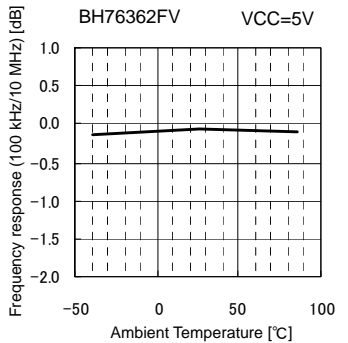

Fig.76 G_F vs. Ambient Temperature

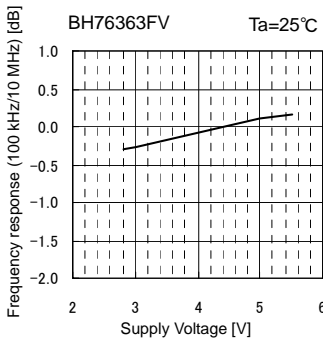

Fig.77 G_F vs. Supply Voltage

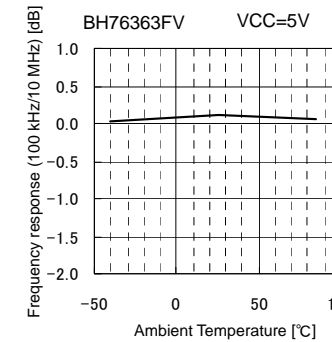

Fig.78 G_F vs. Ambient Temperature

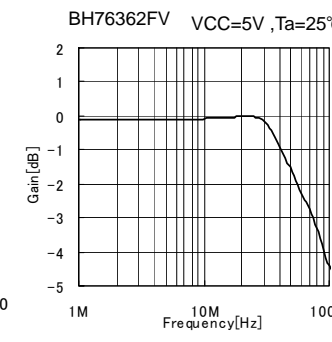

Fig.79 Frequency Response

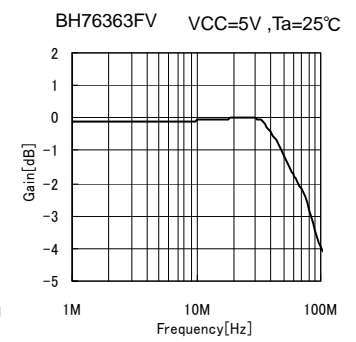

Fig.80 Frequency Response

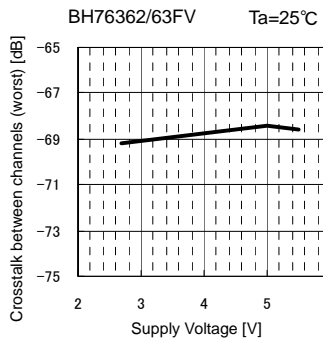

Fig.81 CT(worst) vs. Supply Voltage

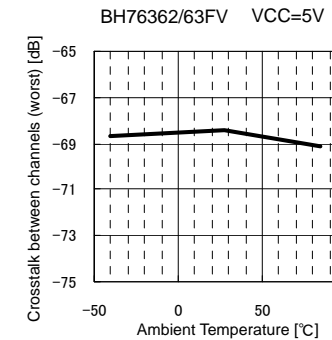

Fig.82 CT(worst) vs. Ambient Temperature

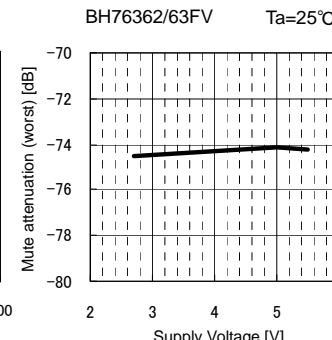

Fig.83 MT(worst) vs. Supply Voltage

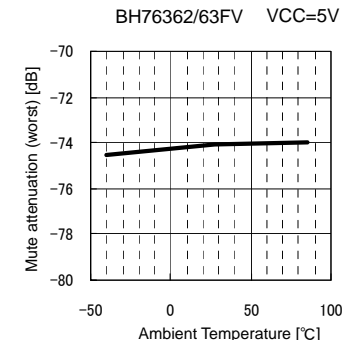

Fig.84 MT(worst) vs. Ambient Temperature

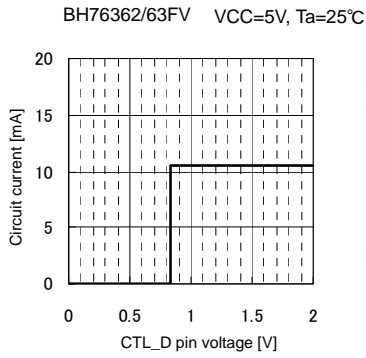

Fig.85 CTLd pin voltage vs Circuit Current (CLT threshold)

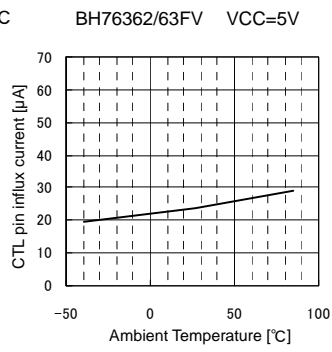

Fig.86 I_{TH} vs. Ambient Temperature (Voltage applied to CTL pin = 2V)

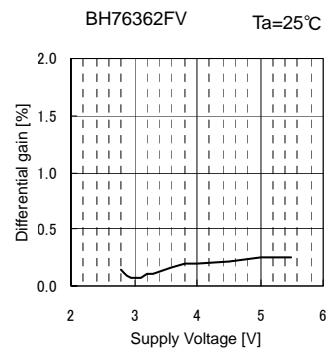

Fig.87 DG vs. Supply Voltage

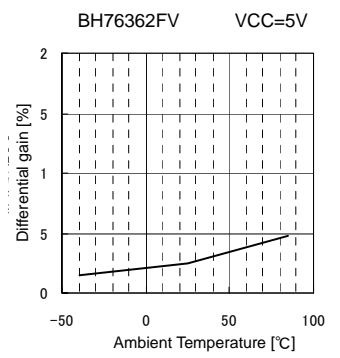

Fig.88 DG vs. Ambient Temperature

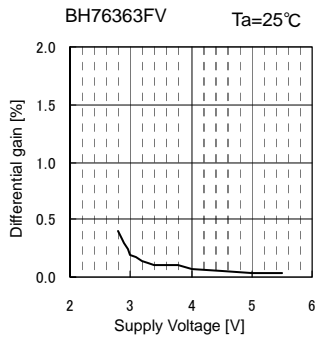

Fig.89 DG vs. Supply Voltage

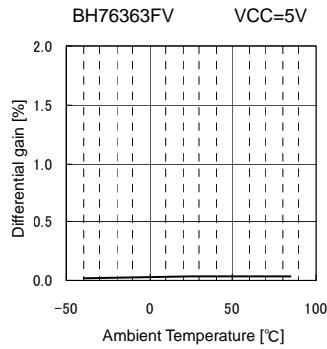

Fig.90 DG vs. Ambient Temperature

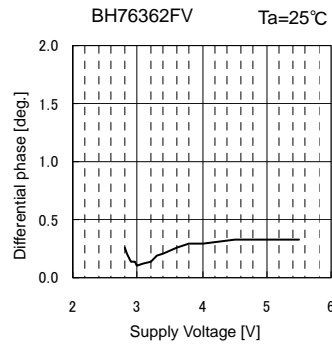

Fig.91 DP vs. Supply Voltage

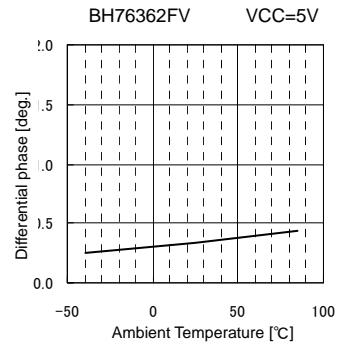

Fig.92 DP vs. Ambient Temperature

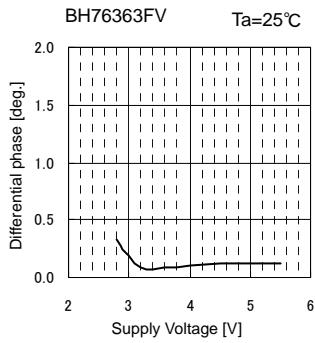

Fig.93 DP vs. Supply Voltage

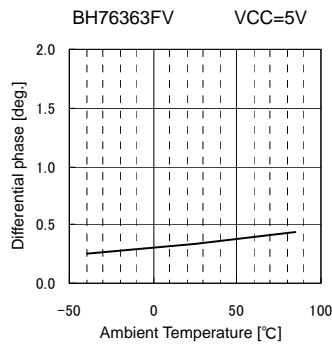

Fig.94 DP vs. Ambient Temperature

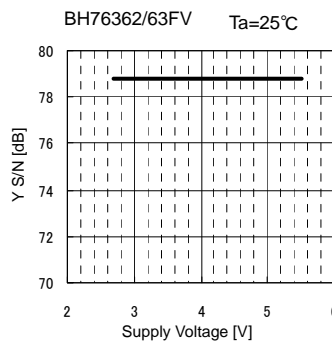

Fig.95 SN_{γ} vs. Supply Voltage

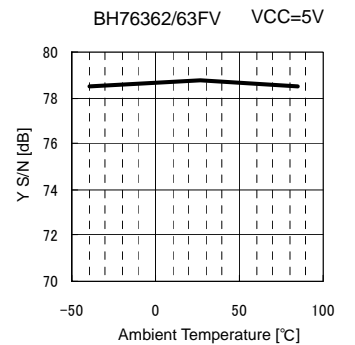

Fig.96 SN_{γ} vs. Ambient Temperature

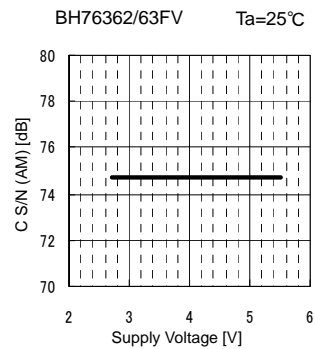

Fig.97 SN_{CA} vs. Supply Voltage

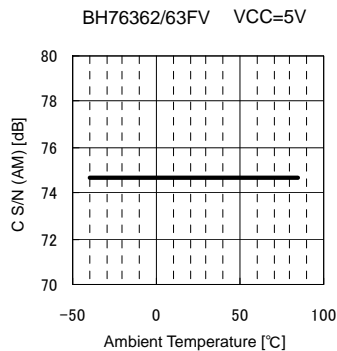

Fig.98 SN_{CA} vs. Ambient Temperature

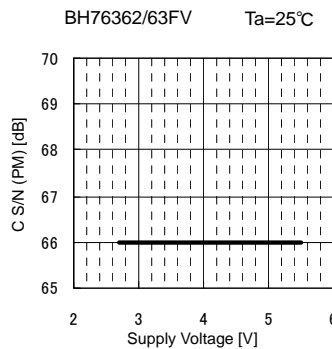

Fig.99 SN_{CP} vs. Supply Voltage

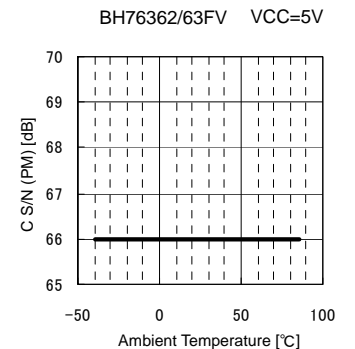
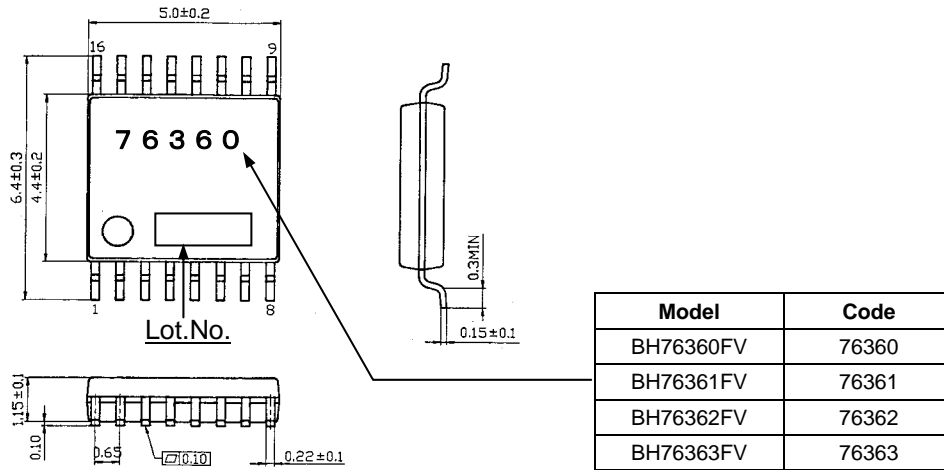

Fig.100 SN_{CP} vs. Ambient Temperature

● External dimensions and label codes



SSOP-B16 (unit: mm)

Fig.101 External Dimensions of BH7636xFV Series Package

● When used with 3-input, 1-output video switch BH7633xFVM

Fig. 14 above shows an application example in which two of these ICs are used. When the similar IC models BH7633xFVM and BH7636xFV are used at the same time, the type of configuration shown below can be combined. In such cases, input coupling capacitors can be used, as in the application example in Fig. 14.

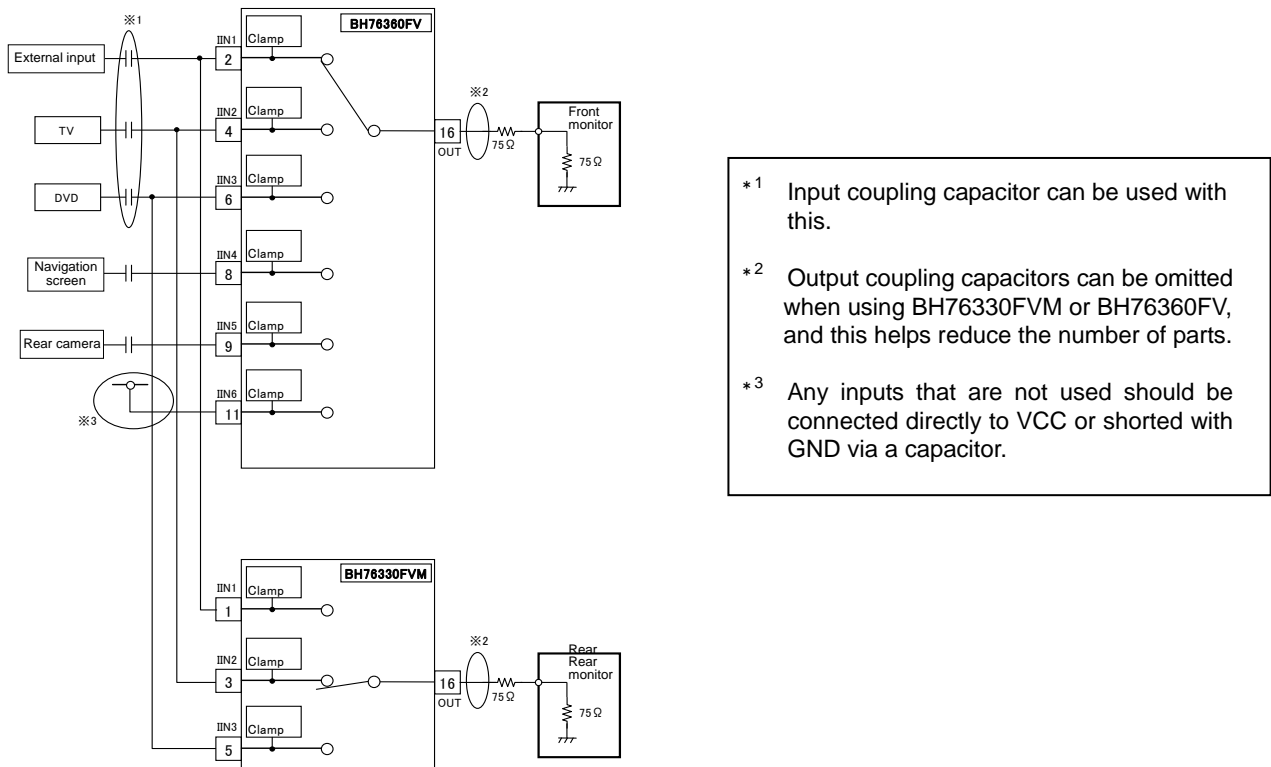
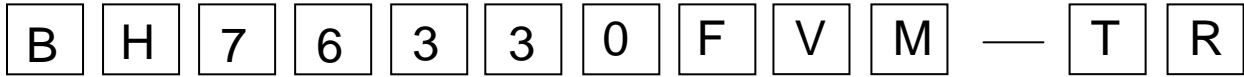

Fig.102 Application Example in which BH76330FVM and BH76360FV Are Used Concurrently

For details of BH7633xFVM, see the BH7633xFVM Series Application Notes.

● Selection of order type



Part No.
 BH76330FVM BH76332FVM
 BH76331FVM BH76333FVM
 BH76360FV BH76362FV
 BH76361FV BH76363FV

Tape and Reel information
 TR
 E2

MSOP8

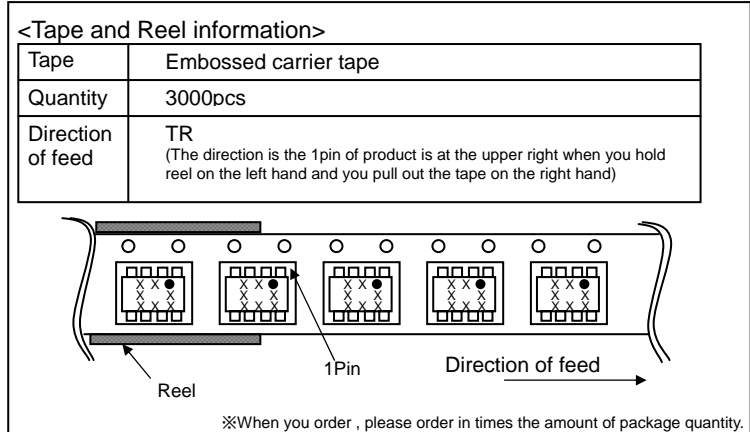
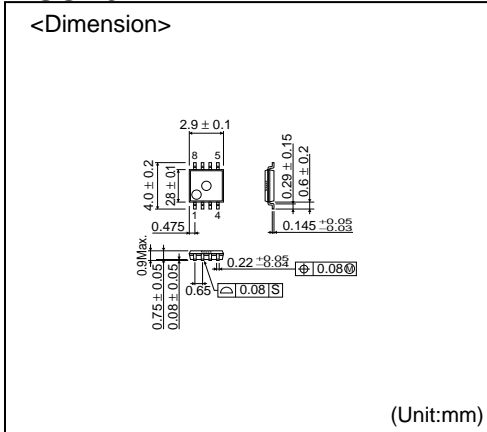

SSOP-B16

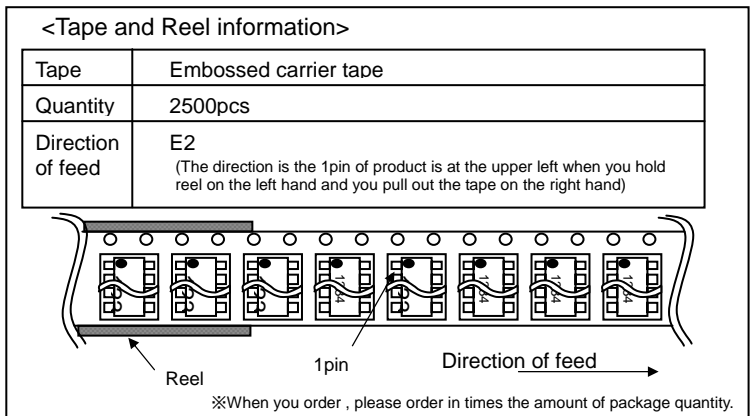
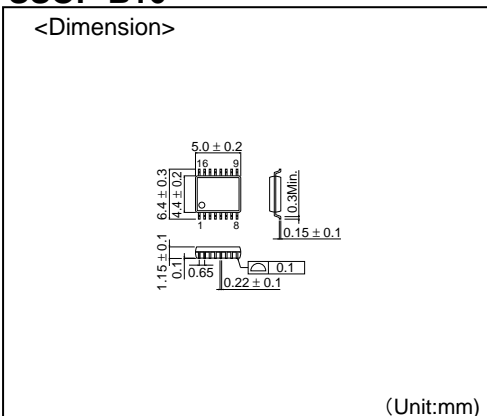

Notes

No copying or reproduction of this document, in part or in whole, is permitted without the consent of ROHM Co.,Ltd.

The content specified herein is subject to change for improvement without notice.

The content specified herein is for the purpose of introducing ROHM's products (hereinafter "Products"). If you wish to use any such Product, please be sure to refer to the specifications, which can be obtained from ROHM upon request.

Examples of application circuits, circuit constants and any other information contained herein illustrate the standard usage and operations of the Products. The peripheral conditions must be taken into account when designing circuits for mass production.

Great care was taken in ensuring the accuracy of the information specified in this document. However, should you incur any damage arising from any inaccuracy or misprint of such information, ROHM shall bear no responsibility for such damage.

The technical information specified herein is intended only to show the typical functions of and examples of application circuits for the Products. ROHM does not grant you, explicitly or implicitly, any license to use or exercise intellectual property or other rights held by ROHM and other parties. ROHM shall bear no responsibility whatsoever for any dispute arising from the use of such technical information.

The Products specified in this document are intended to be used with general-use electronic equipment or devices (such as audio visual equipment, office-automation equipment, communication devices, electronic appliances and amusement devices).

The Products specified in this document are not designed to be radiation tolerant.

While ROHM always makes efforts to enhance the quality and reliability of its Products, a Product may fail or malfunction for a variety of reasons.

Please be sure to implement in your equipment using the Products safety measures to guard against the possibility of physical injury, fire or any other damage caused in the event of the failure of any Product, such as derating, redundancy, fire control and fail-safe designs. ROHM shall bear no responsibility whatsoever for your use of any Product outside of the prescribed scope or not in accordance with the instruction manual.

The Products are not designed or manufactured to be used with any equipment, device or system which requires an extremely high level of reliability the failure or malfunction of which may result in a direct threat to human life or create a risk of human injury (such as a medical instrument, transportation equipment, aerospace machinery, nuclear-reactor controller, fuel-controller or other safety device). ROHM shall bear no responsibility in any way for use of any of the Products for the above special purposes. If a Product is intended to be used for any such special purpose, please contact a ROHM sales representative before purchasing.

If you intend to export or ship overseas any Product or technology specified herein that may be controlled under the Foreign Exchange and the Foreign Trade Law, you will be required to obtain a license or permit under the Law.



Thank you for your accessing to ROHM product informations.
More detail product informations and catalogs are available, please contact us.

ROHM Customer Support System

<http://www.rohm.com/contact/>