

# ESD7421, SZESD7421

## ESD Protection Diodes

### Micro-Packaged Diodes for ESD Protection

The ESD7421 is designed to protect voltage sensitive components from ESD. Excellent clamping capability, low leakage, and fast response time provide best in class protection on designs that are exposed to ESD. Because of its small size, it is suited for use in cellular phones, automotive sensors, infotainment, MP3 players, digital cameras and many other applications where board space comes at a premium.

#### Specification Features

- Low Capacitance 0.3 pF
- Low Clamping Voltage
- Low Leakage 100 nA
- Response Time is < 1 ns
- IEC61000-4-2 Level 4 ESD Protection
- SZ Prefix for Automotive and Other Applications Requiring Unique Site and Control Change Requirements; AEC-Q101 Qualified and PPAP Capable
- These Devices are Pb-Free, Halogen Free/BFR Free and are RoHS Compliant

#### MAXIMUM RATINGS

Rating	Symbol	Value	Unit
IEC 61000-4-2 (ESD) Contact Air		$\pm 12$ $\pm 15$	kV
Total Power Dissipation on FR-5 Board (Note 1) @ $T_A = 25^\circ\text{C}$	$P_D$	300	mW
Thermal Resistance, Junction-to-Ambient	$R_{\theta JA}$	400	$^\circ\text{C}/\text{W}$
Junction and Storage Temperature Range	$T_J, T_{stg}$	-55 to +150	$^\circ\text{C}$
Lead Solder Temperature - Maximum (10 Second Duration)	$T_L$	260	$^\circ\text{C}$

Stresses exceeding those listed in the Maximum Ratings table may damage the device. If any of these limits are exceeded, device functionality should not be assumed, damage may occur and reliability may be affected.

1. FR-5 = 1.0 x 0.75 x 0.62 in.



ON Semiconductor®

[www.onsemi.com](http://www.onsemi.com)



XDFN2  
(SOD-882)  
CASE 711AM

#### MARKING DIAGRAM

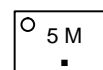

- 5 = Specific Device Code
- M = Date Code
- = Pb-Free Package

#### ORDERING INFORMATION

Device	Package	Shipping†
ESD7421N2T5G	XDFN2 (Pb-Free)	8000 / Tape & Reel
SZESD7421N2T5G	XDFN2 (Pb-Free)	8000 / Tape & Reel

†For information on tape and reel specifications, including part orientation and tape sizes, please refer to our Tape and Reel Packaging Specifications Brochure, BRD8011/D.

See Application Note AND8308/D for further description of survivability specs.

# ESD7421, SZESD7421

## ELECTRICAL CHARACTERISTICS

( $T_A = 25^\circ\text{C}$  unless otherwise noted)

Symbol	Parameter
$I_{PP}$	Maximum Reverse Peak Pulse Current
$V_C$	Clamping Voltage @ $I_{PP}$
$V_{RWM}$	Working Peak Reverse Voltage
$I_R$	Maximum Reverse Leakage Current @ $V_{RWM}$
$V_{BR1}$	Breakdown Voltage @ $I_T$
$V_{BR2}$	Breakdown Voltage @ $I_T$
$I_T$	Test Current

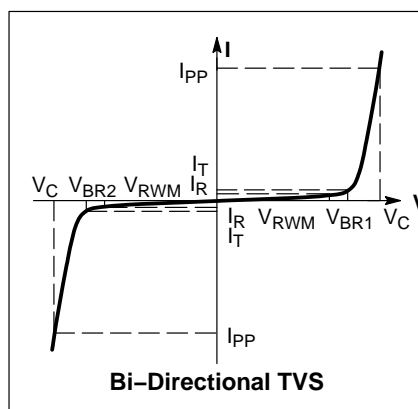

\*See Application Note AND8308/D for detailed explanations of datasheet parameters.

## ELECTRICAL CHARACTERISTICS ( $T_A = 25^\circ\text{C}$ unless otherwise specified)

Parameter	Symbol	Conditions	Min	Typ	Max	Unit
Reverse Working Voltage	$V_{RWM}$	Pin 1 to GND Pin 2 to GND		5 5	16 10	V
Breakdown Voltage	$V_{BR1}$	$I_T = 1\text{ mA}$ , Pin 1 to GND	16.5			V
Breakdown Voltage	$V_{BR2}$	$I_T = 1\text{ mA}$ , Pin 2 to GND	10.5		14	V
Reverse Leakage Current	$I_R$	$V_{RWM} = 5\text{ V}$ , I/O Pin to GND $V_{RWM} = 16\text{ V}$ , Pin 1 to GND		100	500 1.0	nA $\mu\text{A}$
Clamping Voltage (Note 2)	$V_C$	IEC61000-4-2, $\pm 8\text{ kV}$ Contact	See Figures 2 and 3			
Clamping Voltage TLP (Note 3)	$V_C$	$I_{PP} = 8\text{ A}$ $I_{PP} = 16\text{ A}$ $I_{PP} = -8\text{ A}$ $I_{PP} = -16\text{ A}$		35 38.1 -21 -29.5		V
Junction Capacitance	$C_J$	$V_R = 0\text{ V}$ , $f = 1\text{ MHz}$ between I/O Pins and GND		0.3	0.6	pF

Product parametric performance is indicated in the Electrical Characteristics for the listed test conditions, unless otherwise noted. Product performance may not be indicated by the Electrical Characteristics if operated under different conditions.

- For test procedure see Figure 5 and application note AND8307/D.
- ANSI/ESD STM5.5.1 – Electrostatic Discharge Sensitivity Testing using Transmission Line Pulse (TLP) Model.  
TLP conditions:  $Z_0 = 50\ \Omega$ ,  $t_p = 100\text{ ns}$ ,  $t_r = 4\text{ ns}$ , averaging window;  $t_1 = 30\text{ ns}$  to  $t_2 = 60\text{ ns}$ .

**ESD7421, SZESD7421**

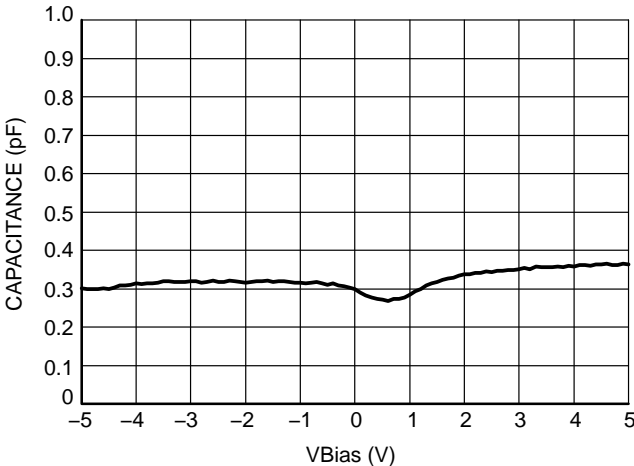

**Figure 1. Typical CV Characteristic Curve  
Pin1 to GND (GND connected to Pin2)**

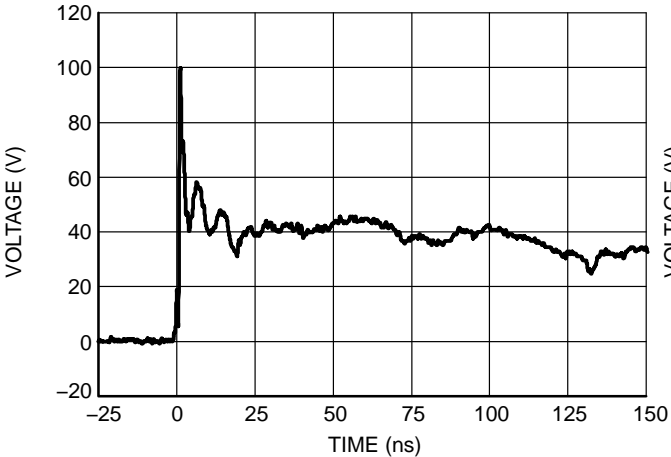

**Figure 2. IEC61000-4-2 +8 kV Contact ESD  
Clamping Voltage  
Pin1 to GND (GND connected to Pin2)**

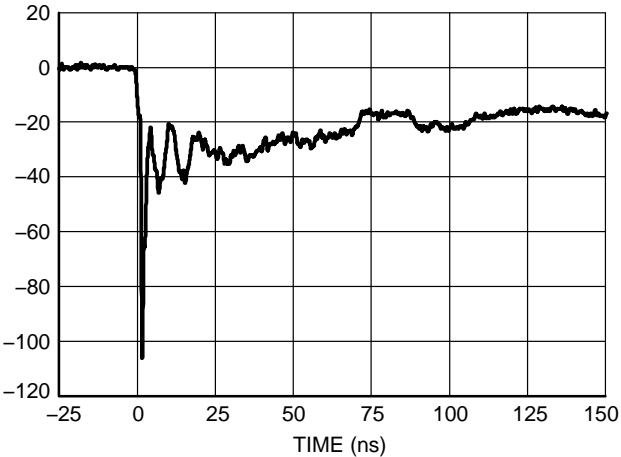

**Figure 3. IEC61000-4-2 -8 kV Contact ESD  
Clamping Voltage  
Pin1 to GND (GND connected to Pin2)**

# ESD7421, SZESD7421

## IEC 61000-4-2 Spec.

Level	Test Voltage (kV)	First Peak Current (A)	Current at 30 ns (A)	Current at 60 ns (A)
1	2	7.5	4	2
2	4	15	8	4
3	6	22.5	12	6
4	8	30	16	8



Figure 4. IEC61000-4-2 Spec

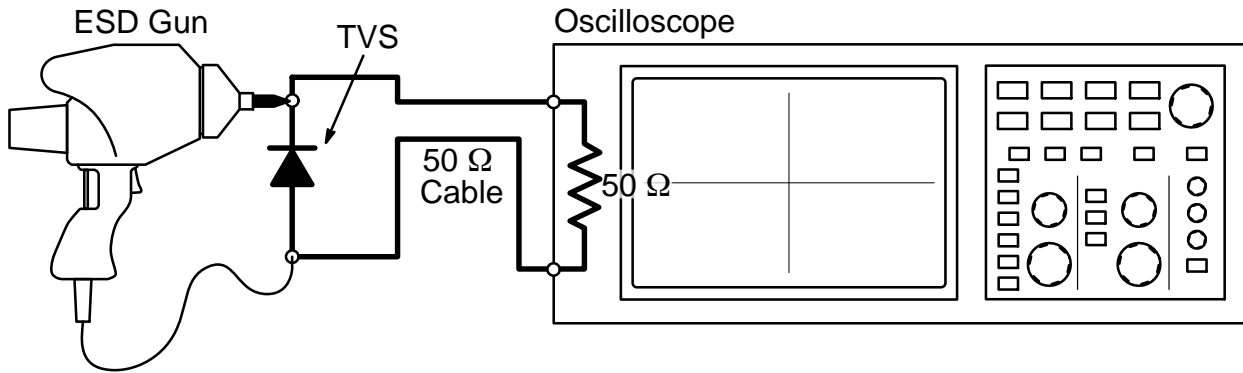

Figure 5. Diagram of ESD Clamping Voltage Test Setup

The following is taken from Application Note AND8308/D – Interpretation of Datasheet Parameters for ESD Devices.

### ESD Voltage Clamping

For sensitive circuit elements it is important to limit the voltage that an IC will be exposed to during an ESD event to as low a voltage as possible. The ESD clamping voltage is the voltage drop across the ESD protection diode during an ESD event per the IEC61000-4-2 waveform. Since the IEC61000-4-2 was written as a pass/fail spec for larger

systems such as cell phones or laptop computers it is not clearly defined in the spec how to specify a clamping voltage at the device level. ON Semiconductor has developed a way to examine the entire voltage waveform across the ESD protection diode over the time domain of an ESD pulse in the form of an oscilloscope screenshot, which can be found on the datasheets for all ESD protection diodes. For more information on how ON Semiconductor creates these screenshots and how to interpret them please refer to AND8307/D.

# ESD7421, SZESD7421

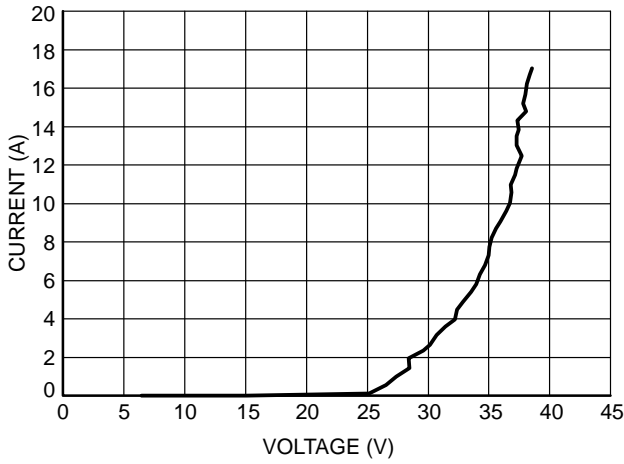

Figure 6. Positive TLP IV Curve

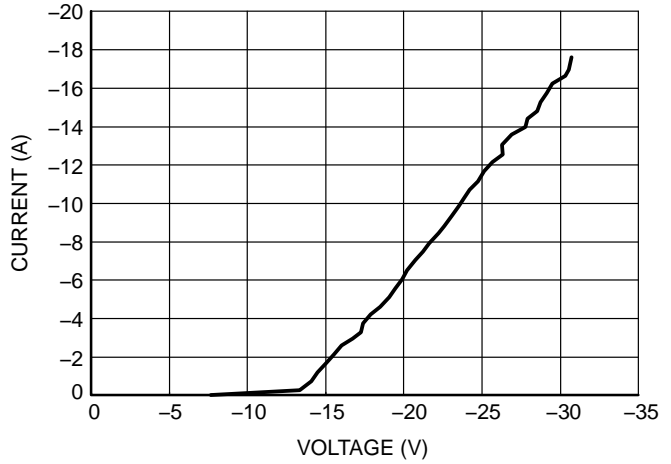

Figure 7. Negative TLP IV Curve

NOTE: TLP parameter:  $Z_0 = 50 \Omega$ ,  $t_p = 100 \text{ ns}$ ,  $t_r = 300 \text{ ps}$ , averaging window:  $t_1 = 30 \text{ ns}$  to  $t_2 = 60 \text{ ns}$ .

## Transmission Line Pulse (TLP) Measurement

Transmission Line Pulse (TLP) provides current versus voltage (I-V) curves in which each data point is obtained from a 100 ns long rectangular pulse from a charged transmission line. A simplified schematic of a typical TLP system is shown in Figure 8. TLP I-V curves of ESD protection devices accurately demonstrate the product's ESD capability because the 10s of amps current levels and under 100 ns time scale match those of an ESD event. This is illustrated in Figure 9 where an 8 kV IEC 61000-4-2 current waveform is compared with TLP current pulses at 8 A and 16 A. A TLP I-V curve shows the voltage at which the device turns on as well as how well the device clamps voltage over a range of current levels.

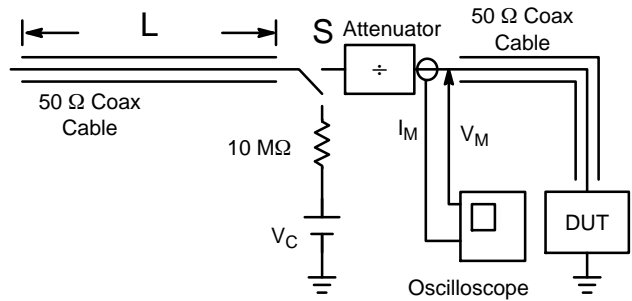

Figure 8. Simplified Schematic of a Typical TLP System

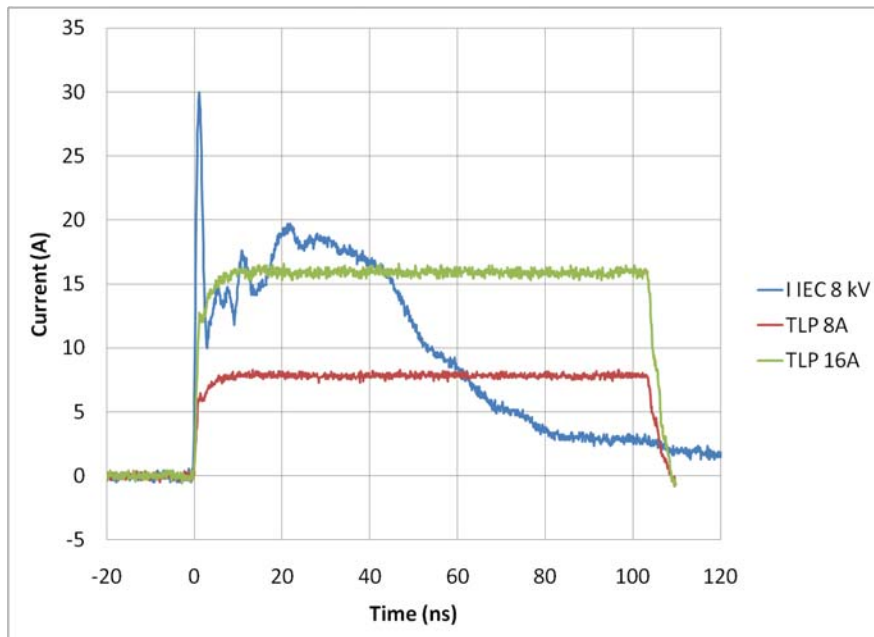
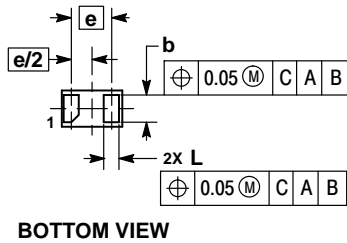
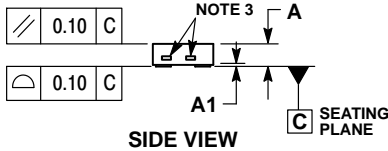
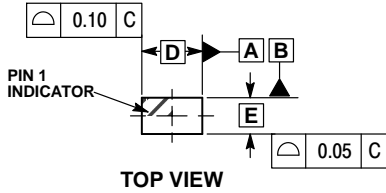

Figure 9. Comparison Between 8 kV IEC 61000-4-2 and 8 A and 16 A TLP Waveforms

# ESD7421, SZESD7421

## PACKAGE DIMENSIONS

### XDFN2 1.0x0.6, 0.65P (SOD-882) CASE 711AM ISSUE O



NOTES:

1. DIMENSIONING AND TOLERANCING PER ASME Y14.5M, 1994.
2. CONTROLLING DIMENSION: MILLIMETERS.
3. EXPOSED COPPER ALLOWED AS SHOWN.

MILLIMETERS		
DIM	MIN	MAX
A	0.34	0.44
A1	—	0.05
b	0.43	0.53
D	1.00	BSC
E	0.60	BSC
e	0.65	BSC
L	0.20	0.30

### RECOMMENDED SOLDER FOOTPRINT\*

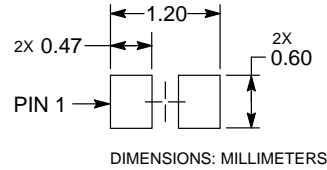

\*For additional information on our Pb-Free strategy and soldering details, please download the ON Semiconductor Soldering and Mounting Techniques Reference Manual, SOLDERRM/D.

ON Semiconductor and are trademarks of Semiconductor Components Industries, LLC dba ON Semiconductor or its subsidiaries in the United States and/or other countries. ON Semiconductor owns the rights to a number of patents, trademarks, copyrights, trade secrets, and other intellectual property. A listing of ON Semiconductor's product/patent coverage may be accessed at [www.onsemi.com/site/pdf/Patent-Marking.pdf](http://www.onsemi.com/site/pdf/Patent-Marking.pdf). ON Semiconductor reserves the right to make changes without further notice to any products herein. ON Semiconductor makes no warranty, representation or guarantee regarding the suitability of its products for any particular purpose, nor does ON Semiconductor assume any liability arising out of the application or use of any product or circuit, and specifically disclaims any and all liability, including without limitation special, consequential or incidental damages. Buyer is responsible for its products and applications using ON Semiconductor products, including compliance with all laws, regulations and safety requirements or standards, regardless of any support or applications information provided by ON Semiconductor. "Typical" parameters which may be provided in ON Semiconductor data sheets and/or specifications can and do vary in different applications and actual performance may vary over time. All operating parameters, including "Typicals" must be validated for each customer application by customer's technical experts. ON Semiconductor does not convey any license under its patent rights nor the rights of others. ON Semiconductor products are not designed, intended, or authorized for use as a critical component in life support systems or any FDA Class 3 medical devices or medical devices with a same or similar classification in a foreign jurisdiction or any devices intended for implantation in the human body. Should Buyer purchase or use ON Semiconductor products for any such unintended or unauthorized application, Buyer shall indemnify and hold ON Semiconductor and its officers, employees, subsidiaries, affiliates, and distributors harmless against all claims, costs, damages, and expenses, and reasonable attorney fees arising out of, directly or indirectly, any claim of personal injury or death associated with such unintended or unauthorized use, even if such claim alleges that ON Semiconductor was negligent regarding the design or manufacture of the part. ON Semiconductor is an Equal Opportunity/Affirmative Action Employer. This literature is subject to all applicable copyright laws and is not for resale in any manner.

### PUBLICATION ORDERING INFORMATION

**LITERATURE FULFILLMENT:**

Literature Distribution Center for ON Semiconductor  
19521 E. 32nd Pkwy, Aurora, Colorado 80011 USA  
Phone: 303-675-2175 or 800-344-3860 Toll Free USA/Canada  
Fax: 303-675-2176 or 800-344-3867 Toll Free USA/Canada  
Email: [orderlit@onsemi.com](mailto:orderlit@onsemi.com)

**N. American Technical Support:** 800-282-9855 Toll Free  
USA/Canada  
**Europe, Middle East and Africa Technical Support:**  
Phone: 421 33 790 2910  
**Japan Customer Focus Center**  
Phone: 81-3-5817-1050

**ON Semiconductor Website:** [www.onsemi.com](http://www.onsemi.com)  
**Order Literature:** <http://www.onsemi.com/orderlit>

For additional information, please contact your local Sales Representative